



US00D914806S

(12) **United States Design Patent**  
**Peeters et al.**

(10) **Patent No.: US D914,806 S**  
(45) **Date of Patent: \*\* Mar. 30, 2021**

(54) **GAME BOARD AND GAME PIECES**

(71) Applicant: **SMART N.V.**, Kontich (BE)

(72) Inventors: **Raf Peeters**, Lier (BE); **Leighton Meredith Rees**, Cirencester (GB)

(73) Assignee: **Smart N.V.**, Kontich (BE)

(\*\*) Term: **15 Years**

(21) Appl. No.: **29/687,423**

(22) Filed: **Apr. 12, 2019**

(30) **Foreign Application Priority Data**

Oct. 30, 2018 (EM) ..... 005813094

(51) **LOC (13) Cl.** ..... **21-01**

(52) **U.S. Cl.**

USPC ..... **D21/360; D21/350; D21/334**

(58) **Field of Classification Search**

USPC ..... D21/334, 335-342, 355-359, 365, 318, D21/397, 351, 385, 386, 389, 404, 478, D21/479, 483-486, 489-491, 493, 494, D21/497, 499, 507, 510, 511, 561; 273/241, 242, 244-247, 259, 271-281, 273/282.1-282.3, 284, 287, 317.3, 108.1, 273/108.5, 118 D, 236-240, 283, 309, 273/441, 461, 288-290, 153 R, 156, 273/153 S; D6/406.1, 406.3, 406.4, D6/406.6; D19/86, 92, 95, 87, 113, 75, D19/77, 78, 80, 60, 59, 64, 63; 108/14, 108/62, 43, 67; 434/81, 82, 96, 128, 365, 434/393, 403, 428, 429, 433, 416, 247, 434/248, 251, 408, 413, 145, 430; 446/82-84, 85, 97, 99, 101, 102, 118, 446/124, 268, 330, 476, 491, 901

CPC ..... A63F 3/00; A63F 3/0003; A63F 3/00028; A63F 3/00041; A63F 3/00044; A63F 3/00047; A63F 3/00173; A63F 3/00176; A63F 3/00214; A63F 3/00261; A63F 3/00643; A63F 3/00646-00659; A63F 3/04; A63F 3/00097; A63F 3/0434; A63F

3/00148; A63F 3/00697; A63F 3/0023; A63F 3/00895; A63F 3/00574; A63F 3/00694; A63F 2003/00182; A63F 2003/00223; A63F 2003/00457; A63F 2003/0046; A63F 2003/00463; A63F 2003/00466; A63F 2003/0047; A63F 2003/00485; A63F 2003/00492; A63F 2003/00507; A63F 2003/00514; A63F 2003/00533; A63F 2003/00552; A63F 2003/00558; A63F 2003/00943; A63F 2003/00946; A63F 2003/00952-3/00962; A63F 2003/00974; A63F 7/00; A63F 7/06; A63F 7/0612; A63F 7/0604; A63F 7/0616-0636; A63F 7/30; A63F 7/36; A63F 7/0005; A63F 7/0017; A63F 7/0023; A63F 2007/0035; A63F 2007/367; A63F 2007/3674; A63F 9/00; A63F 9/08; A63F 9/001; A63F 9/0826; A63F 9/0073; A63F 9/0078; A63F 9/0602; A63F 9/0613; A63F 9/12-1208; A63F 9/1288; A63F 2009/0012; A63F 2009/1212-1228; A63F 2009/1292; A63F 2009/1296

See application file for complete search history.

(56)

**References Cited**

**U.S. PATENT DOCUMENTS**

873,031 A \* 12/1907 Doan et al. .... A63F 3/00574  
273/282.1  
D46,256 S \* 8/1914 Lahiere ..... D21/564  
1,221,493 A \* 4/1917 Whitaker ..... A63F 3/00697  
273/282.1  
1,343,984 A \* 6/1920 Ramsey ..... A63F 3/027  
273/282.1  
3,170,697 A \* 2/1965 Banks ..... A63F 3/065  
273/282.1  
3,345,071 A \* 10/1967 Nekton ..... A63F 3/022  
273/282.1  
3,531,122 A \* 9/1970 Peebles ..... A63F 3/00697  
273/282.1  
3,588,112 A \* 6/1971 Holt ..... A63F 3/00574  
273/282.1  
3,589,060 A \* 6/1971 Genin ..... A63H 13/20  
446/246

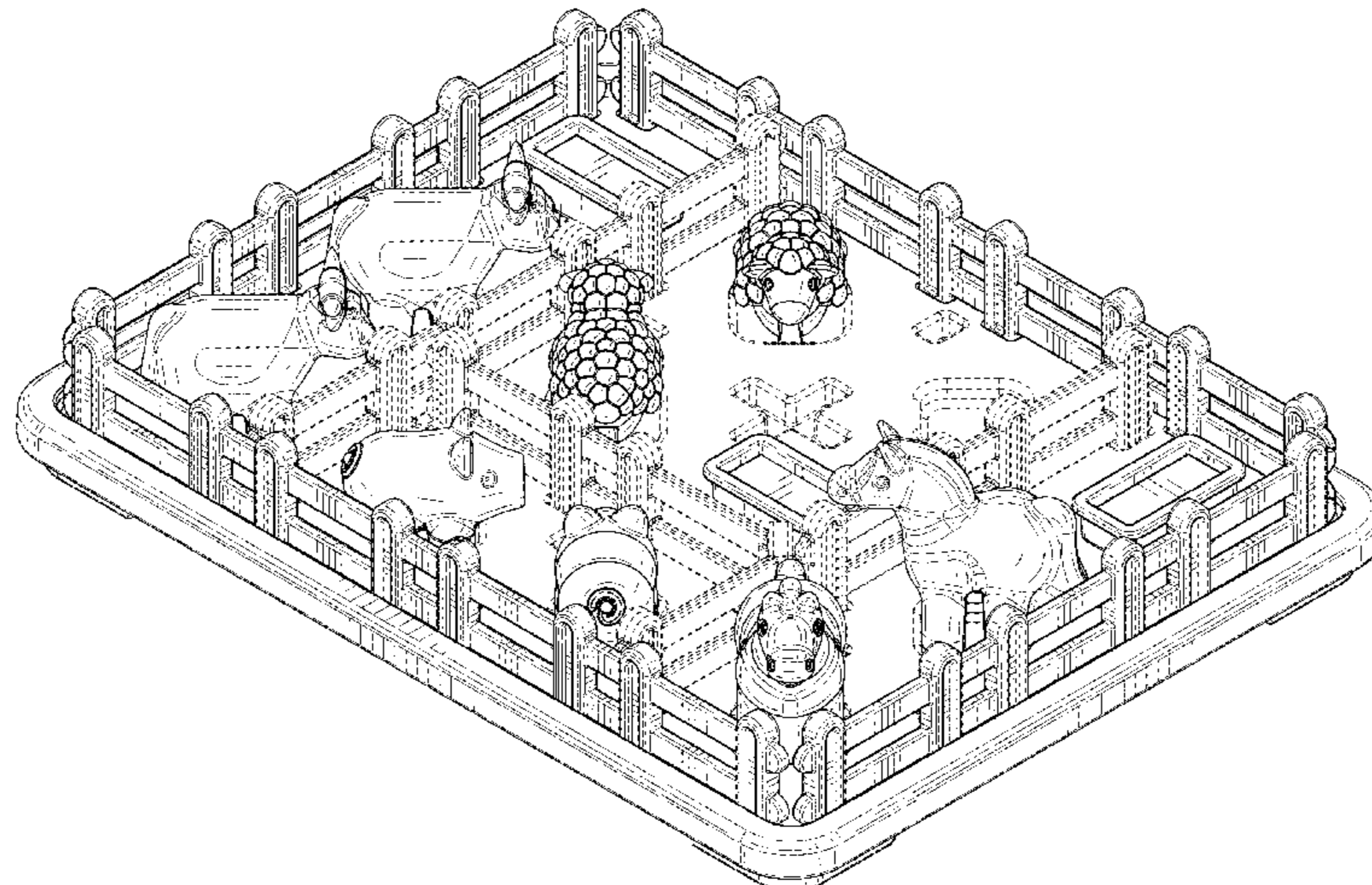

3,698,122 A \* 10/1972 Adams ..... A63F 9/10  
446/118  
3,751,827 A \* 8/1973 Gaskin ..... G09B 23/40  
434/152  
3,751,849 A \* 8/1973 Goldfarb ..... A63H 13/04  
446/246  
3,754,759 A \* 8/1973 Breslow ..... A63F 9/30  
273/440  
3,823,944 A \* 7/1974 Stubbmann ..... A63F 3/0695  
273/281  
4,067,576 A \* 1/1978 Balas ..... A63F 7/0076  
273/120 R  
4,136,883 A \* 1/1979 Klees ..... A63F 3/00261  
273/281  
D252,953 S \* 9/1979 Pagani ..... D21/338  
4,175,742 A \* 11/1979 Todokoro ..... A63F 9/30  
273/447  
4,224,761 A \* 9/1980 Wakimura ..... A63F 9/305  
273/237  
4,228,615 A \* 10/1980 Melotti ..... A63H 3/16  
446/99  
4,229,003 A \* 10/1980 Shimizu ..... A63F 9/34  
273/448  
4,234,181 A \* 11/1980 Breslow ..... A63F 9/30  
273/440  
D264,857 S \* 6/1982 Aitkens ..... D21/338  
4,418,908 A \* 12/1983 Kinberg ..... A63F 9/0079  
273/108  
D272,253 S \* 1/1984 Du Plessis ..... D21/338  
4,504,243 A \* 3/1985 Barlow ..... A63F 3/00634  
446/444  
4,512,584 A \* 4/1985 Propsom ..... A63F 3/00574  
273/282.1  
4,524,967 A \* 6/1985 Hanson ..... A63F 9/30  
273/273  
4,551,103 A \* 11/1985 Vitale ..... A63F 3/00063  
434/225  
4,685,884 A \* 8/1987 Rohan ..... G09B 25/06  
273/157 R  
D299,499 S \* 1/1989 Gould ..... D21/478  
D300,441 S \* 3/1989 Ryland ..... D21/609  
4,838,553 A \* 6/1989 Chaun-Tien ..... A63F 9/305  
273/447  
5,219,170 A \* 6/1993 Ledford ..... A63F 3/00574  
273/248  
D339,390 S \* 9/1993 Lammertink ..... D21/478  
D347,662 S \* 6/1994 Johnson ..... D21/351  
D349,530 S \* 8/1994 Pedersen ..... D21/615  
D349,538 S \* 8/1994 Pedersen ..... D21/615  
5,427,379 A \* 6/1995 Lee ..... A63F 3/00634  
273/264  
D367,502 S \* 2/1996 Armendariz ..... D21/478  
D371,578 S \* 7/1996 Henderson ..... D21/338  
5,558,336 A \* 9/1996 Sapello ..... A63F 3/00634  
273/281  
D379,387 S \* 5/1997 Stephensen ..... D21/654  
5,702,108 A \* 12/1997 Todokoro ..... A63F 9/30  
273/120 R  
D389,872 S \* 1/1998 Rhea ..... D21/360  
D390,279 S \* 2/1998 Foster ..... D21/360  
D395,468 S \* 6/1998 Wagner ..... D21/478  
5,827,105 A \* 10/1998 Felgenhauer ..... A63H 19/36  
446/120  
D400,936 S \* 11/1998 Wagner ..... D21/478  
D405,128 S \* 2/1999 Vallier ..... D21/350  
6,345,822 B1 \* 2/2002 Reynolds ..... A63F 3/00261  
273/281  
D456,468 S \* 4/2002 Roker ..... D21/654  
6,551,164 B1 \* 4/2003 Motosko ..... A63G 1/30  
280/1.13  
D491,234 S \* 6/2004 Rom ..... D21/478  
D501,231 S \* 1/2005 Rom ..... D21/478  
D517,619 S \* 3/2006 Saruhashi ..... D21/576  
D535,337 S \* 1/2007 Liu ..... D21/300  
D535,704 S \* 1/2007 Chow ..... D21/300  
D539,359 S \* 3/2007 Rom ..... D21/478  
D586,230 S \* 2/2009 Pierre ..... D21/655

D660,371 S \* 5/2012 Fuchs ..... D21/338  
D667,506 S \* 9/2012 Peeters ..... D21/478  
D698,094 S \* 1/2014 Paculdo ..... D30/121  
8,870,185 B2 \* 10/2014 Cheng ..... A63F 3/00574  
273/281  
8,998,670 B1 \* 4/2015 De Leon ..... A63H 3/46  
446/97  
D753,242 S \* 4/2016 Jaensch ..... D21/626  
D754,803 S \* 4/2016 Jaensch ..... D21/621  
D755,311 S \* 5/2016 Jaensch ..... D21/649  
D773,557 S \* 12/2016 Huang ..... D19/59  
D894,291 S \* 8/2020 Poulus ..... D21/478  
2016/0067619 A1 \* 3/2016 Botterill ..... A63H 33/04  
446/99

\* cited by examiner

Primary Examiner — Susan Moon Lee

(74) Attorney, Agent, or Firm — Hodgson Russ LLP

(57) CLAIM

The ornamental design for a game board and game pieces, as shown and described.

DESCRIPTION

FIG. 1 is a top perspective view of the game board component shown separately for clarity of illustration;  
FIG. 2 is a front elevational view of the game board of FIG. 1;  
FIG. 3 is a rear elevational view of the game board of FIG. 1;  
FIG. 4 is a right side view of the game board of FIG. 1;  
FIG. 5 is a left side view of the game board of FIG. 1;  
FIG. 6 is a top view of the game board of FIG. 1;  
FIG. 7 is a bottom view of the game board of FIG. 1;  
FIG. 8 is a top perspective view of a game piece, shown separately for clarity of illustration;  
FIG. 9 is a left side view of the game piece of FIG. 8;  
FIG. 10 is a right side view of the game piece of FIG. 8;  
FIG. 11 is a front elevational view of the game piece of FIG. 8;  
FIG. 12 is a rear elevational view of the game piece of FIG. 8;  
FIG. 13 is a top view of the game piece of FIG. 8;  
FIG. 14 is a bottom view of the game piece of FIG. 8;  
FIG. 15 is a top perspective view of a game piece, shown separately for clarity of illustration;  
FIG. 16 is a left side view of the game piece of FIG. 15;  
FIG. 17 is a right side view of the game piece of FIG. 15;  
FIG. 18 is a front elevational view of the game piece of FIG. 15;  
FIG. 19 is a rear elevational view of the game piece of FIG. 15;  
FIG. 20 is a top view of the game piece of FIG. 15;  
FIG. 21 is a bottom view of the game piece of FIG. 15;  
FIG. 22 is a top perspective view of a game piece, shown separately for clarity of illustration;  
FIG. 23 is a left side view of the game piece of FIG. 22;  
FIG. 24 is a right side view of the game piece of FIG. 22;  
FIG. 25 is a front elevational view of the game piece of FIG. 22;  
FIG. 26 is a rear elevational view of the game piece of FIG. 22;  
FIG. 27 is a top view of the game piece of FIG. 22;  
FIG. 28 is a bottom view of the game piece of FIG. 22;  
FIG. 29 is a top perspective view of a game piece, shown separately for clarity of illustration;

FIG. 30 is a left side view of the game piece of FIG. 29;  
FIG. 31 is a right side view of the game piece of FIG. 29;  
FIG. 32 is a front elevational view of the game piece of FIG. 29;  
FIG. 33 is a rear elevational view of the game piece of FIG. 29;  
FIG. 34 is a top view of the game piece of FIG. 29;  
FIG. 35 is a bottom view of the game piece of FIG. 29;  
FIG. 36 is a top perspective view of a game piece, shown separately for clarity of illustration;  
FIG. 37 is a right side view of the game piece of FIG. 36;  
FIG. 38 is a left side view of the game piece of FIG. 36;  
FIG. 39 is a front elevational view of the game piece of FIG. 36;  
FIG. 40 is a rear elevational view of the game piece of FIG. 36;  
FIG. 41 is a top view of the game piece of FIG. 36;  
FIG. 42 is a bottom view of the game piece of FIG. 36;  
FIG. 43 is a top perspective view of a game piece, shown separately for clarity of illustration;  
FIG. 44 is a front elevational view of the game piece of FIG. 43;  
FIG. 45 is a rear elevational view of the game piece of FIG. 43;  
FIG. 46 is a right side view of the game piece of FIG. 43;  
FIG. 47 is a left side view of the game piece of FIG. 43;  
FIG. 48 is a top view of the game piece of FIG. 43;

FIG. 49 is a bottom view of the game piece of FIG. 43;  
FIG. 50 is a top perspective view of a game piece, shown separately for clarity of illustration;  
FIG. 51 is a front elevational view of the game piece of FIG. 50;  
FIG. 52 is a rear elevational view of the game piece of FIG. 50;  
FIG. 53 is a right side view of the game piece of FIG. 50;  
FIG. 54 is a left side view of the game piece of FIG. 50;  
FIG. 55 is a top view of the game piece of FIG. 50;  
FIG. 56 is a bottom view of the game piece of FIG. 50;  
FIG. 57 is a top perspective view of a game piece, shown separately for clarity of illustration;  
FIG. 58 is a front elevational view of the game piece of FIG. 57;  
FIG. 59 is a rear elevational view of the game piece of FIG. 57;  
FIG. 60 is a right side view of the game piece of FIG. 57;  
FIG. 61 is a left side view of the game piece of FIG. 57;  
FIG. 62 is a top view of the game piece of FIG. 57;  
FIG. 63 is a bottom view of the game piece of FIG. 57; and,  
FIG. 64 is a top perspective view of the game board and game pieces in accordance with our new design.  
The evenly-dashed broken lines in the drawings illustrate the portions of the game pieces and game board that form no part of the claim.

**1 Claim, 56 Drawing Sheets**

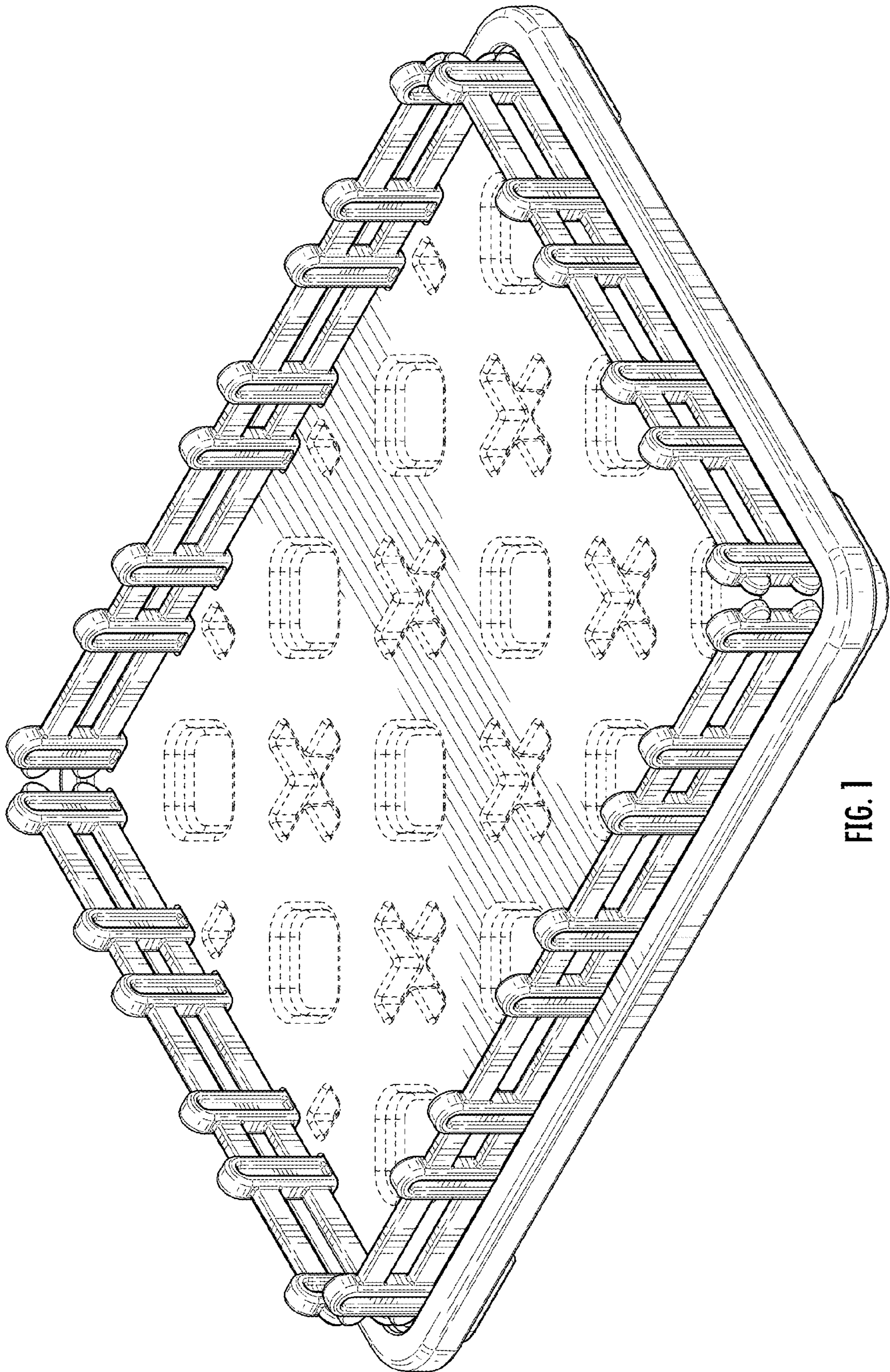

FIG. 1

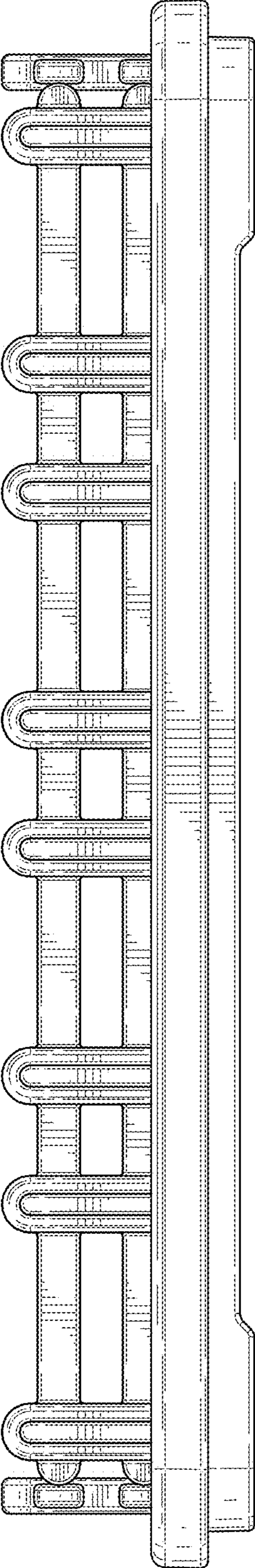

FIG. 2

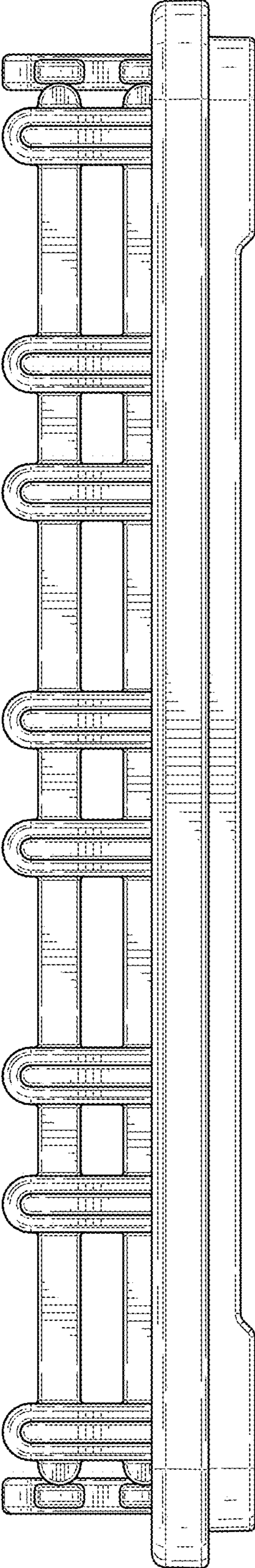

FIG. 3

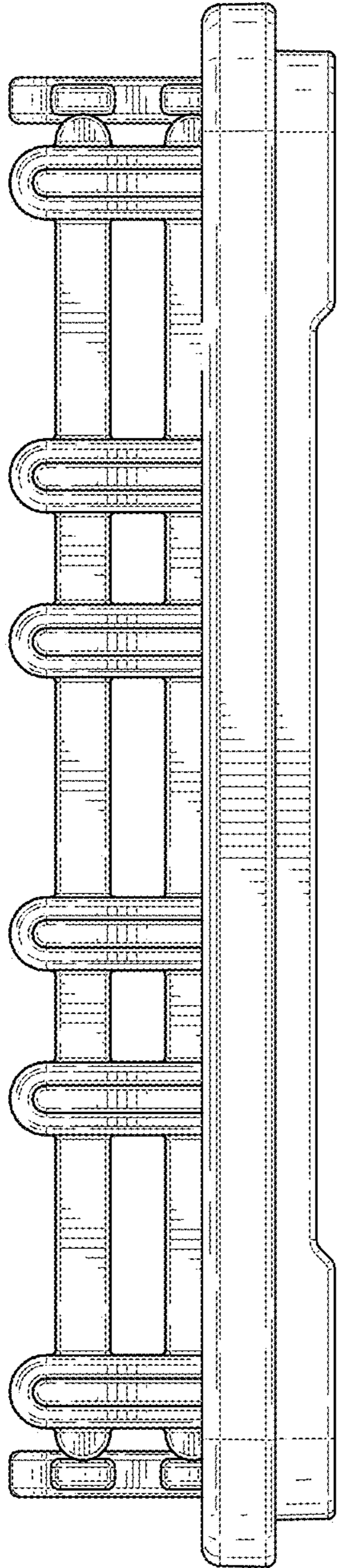

FIG. 4

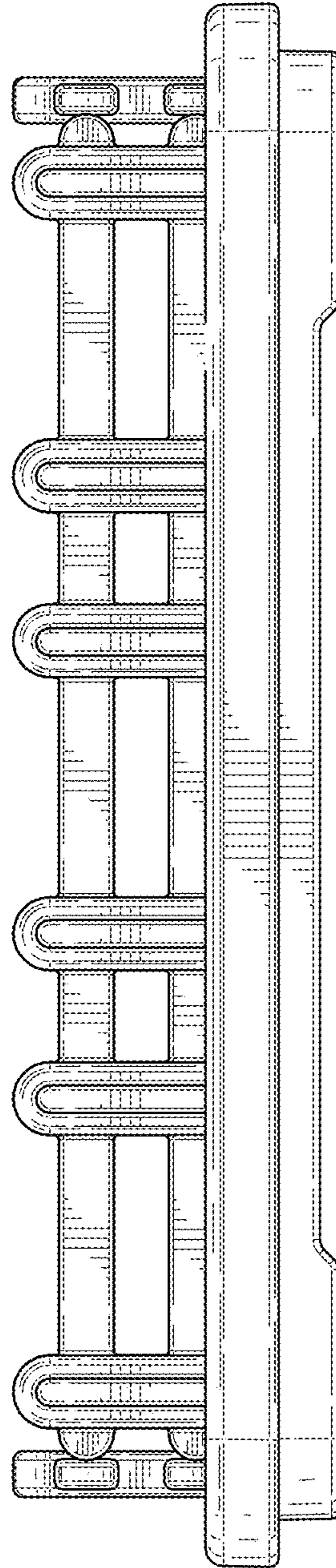

FIG. 5

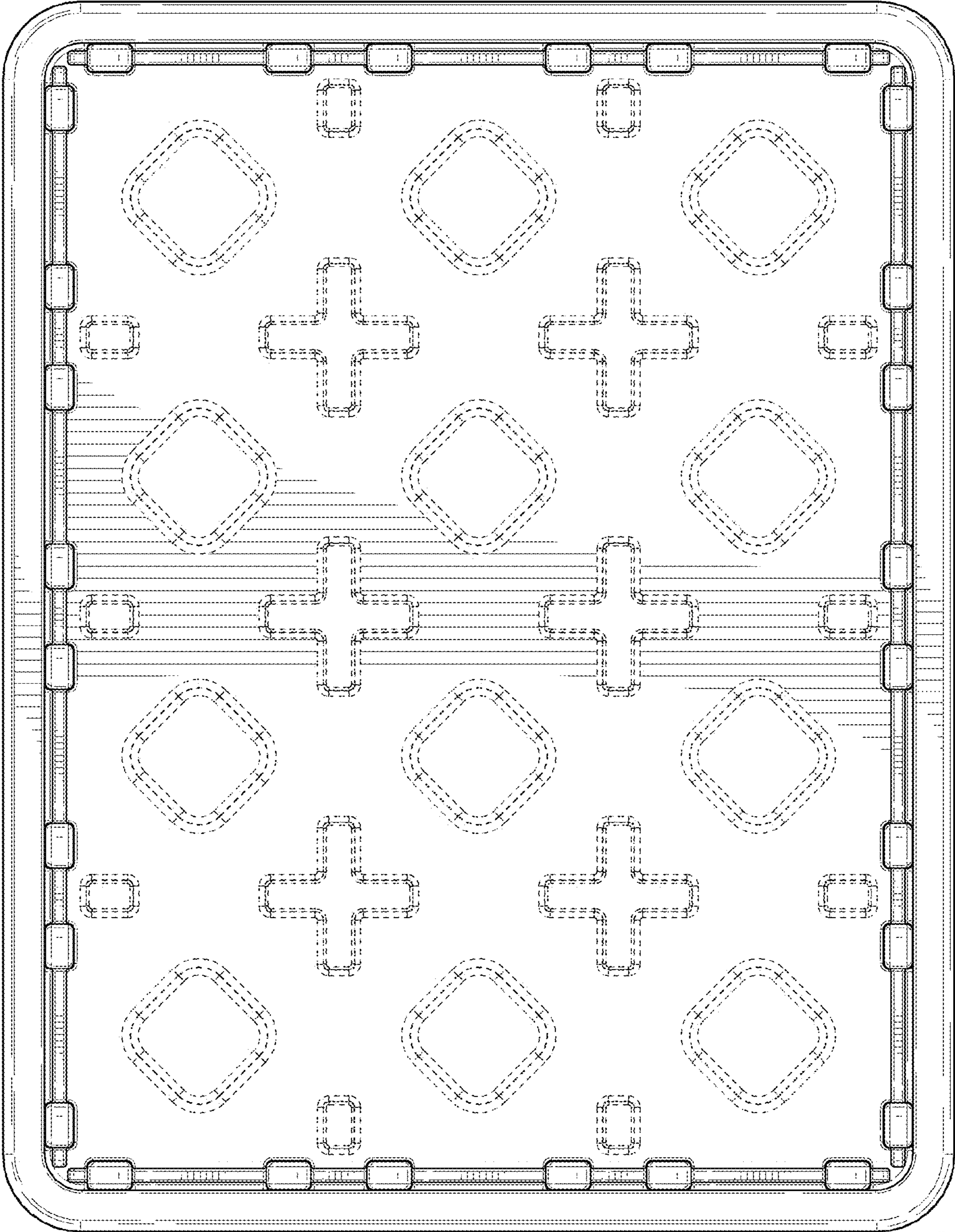

FIG. 6

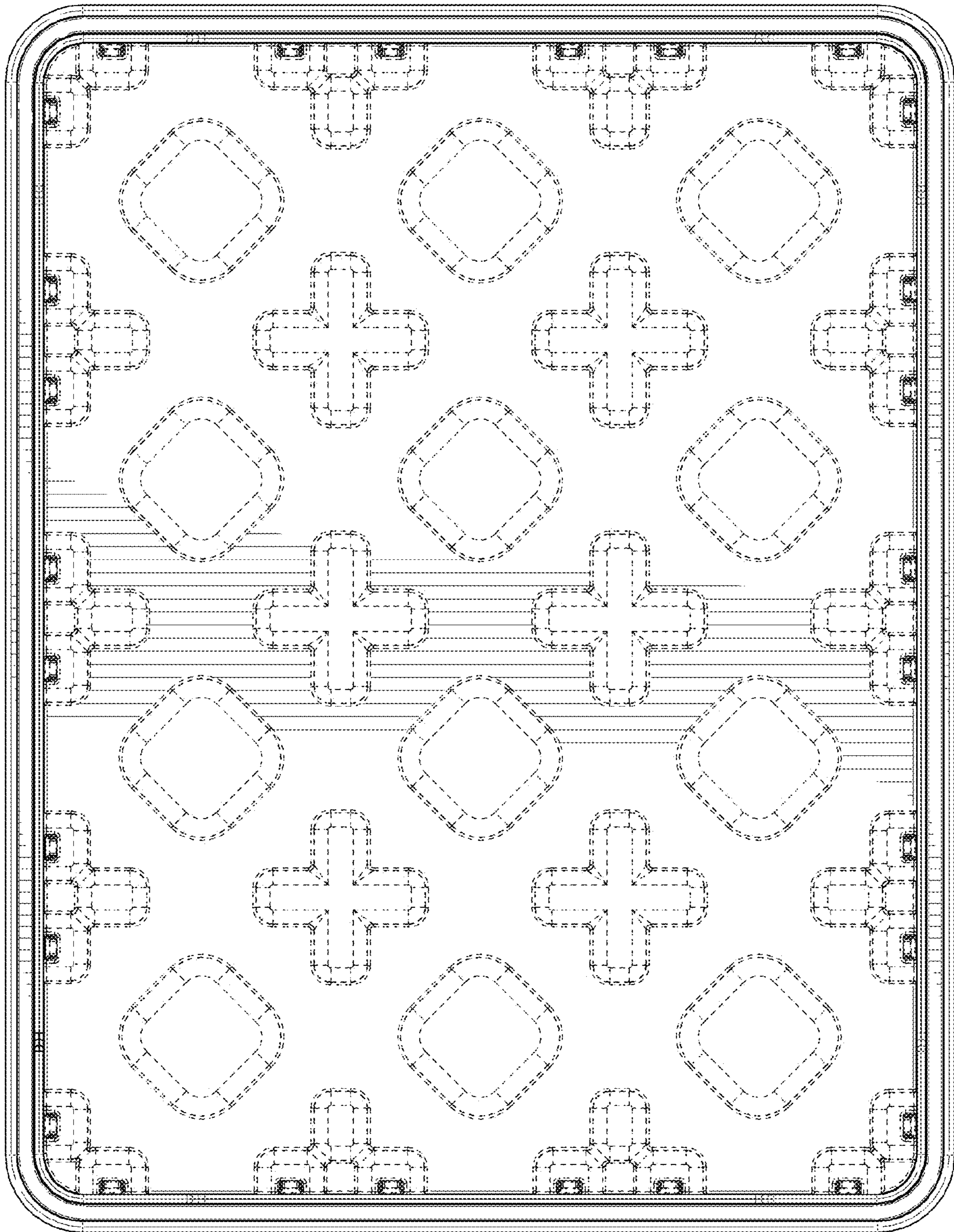

FIG. 7



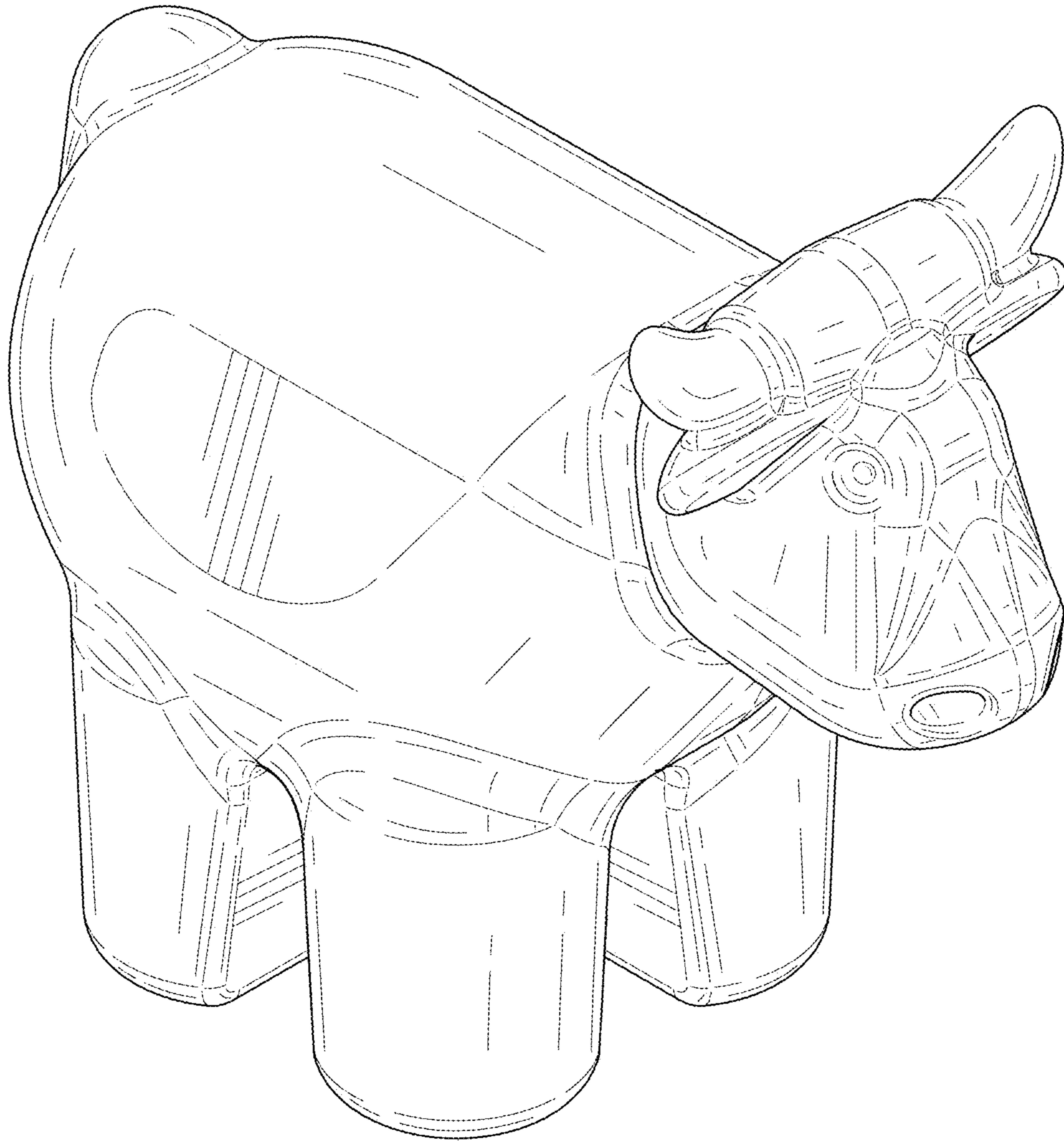

FIG. 8

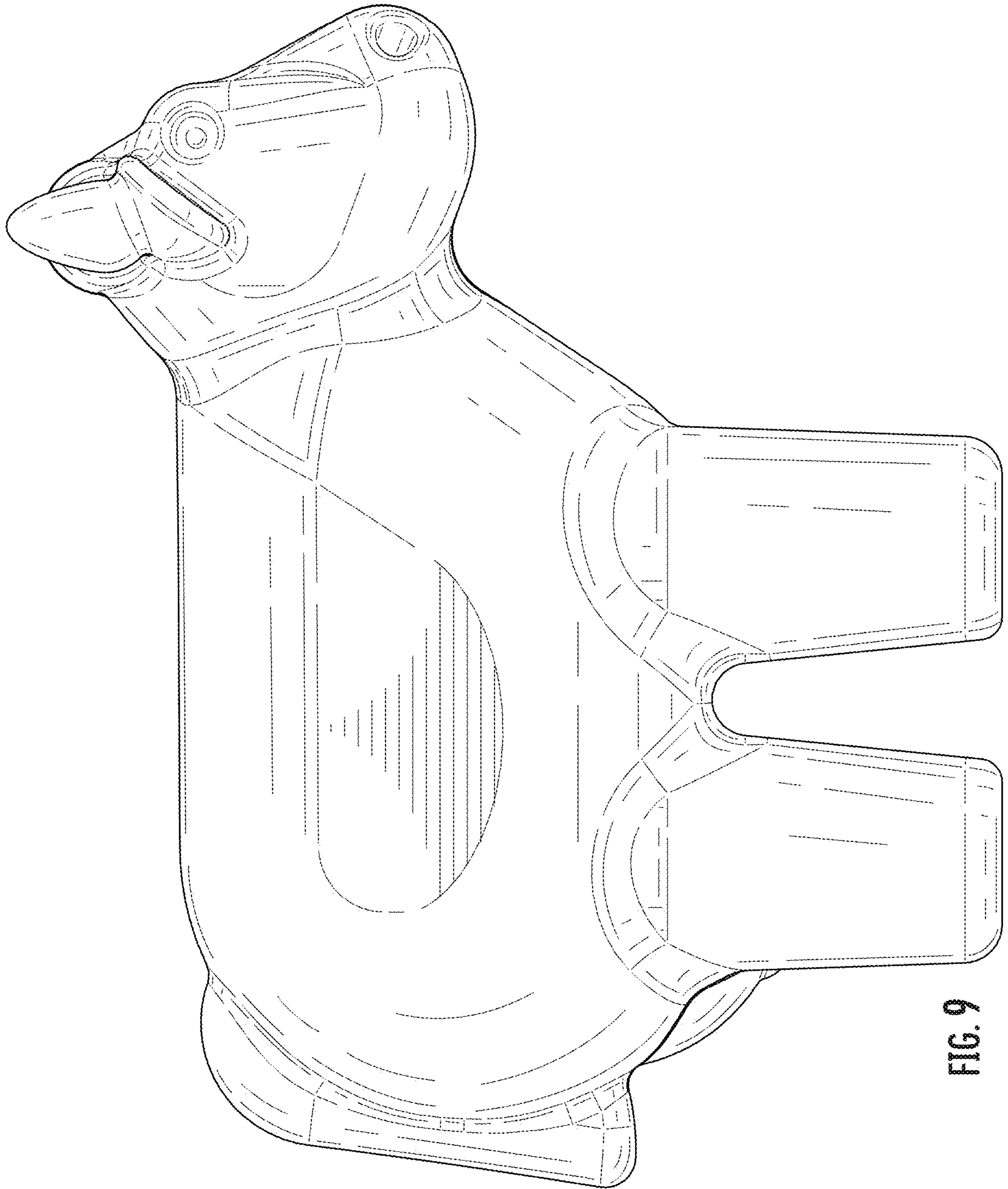

FIG. 9

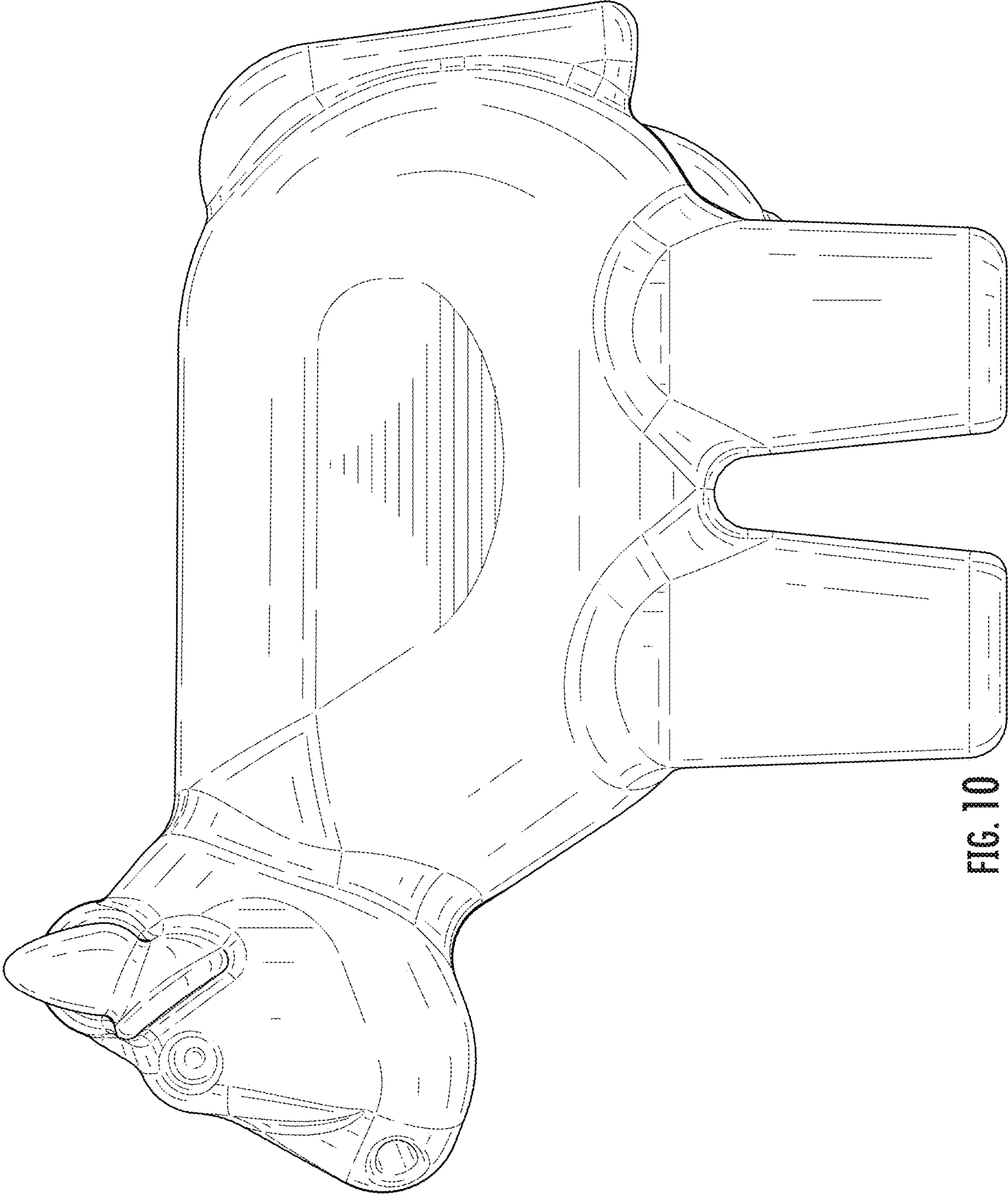

FIG. 10

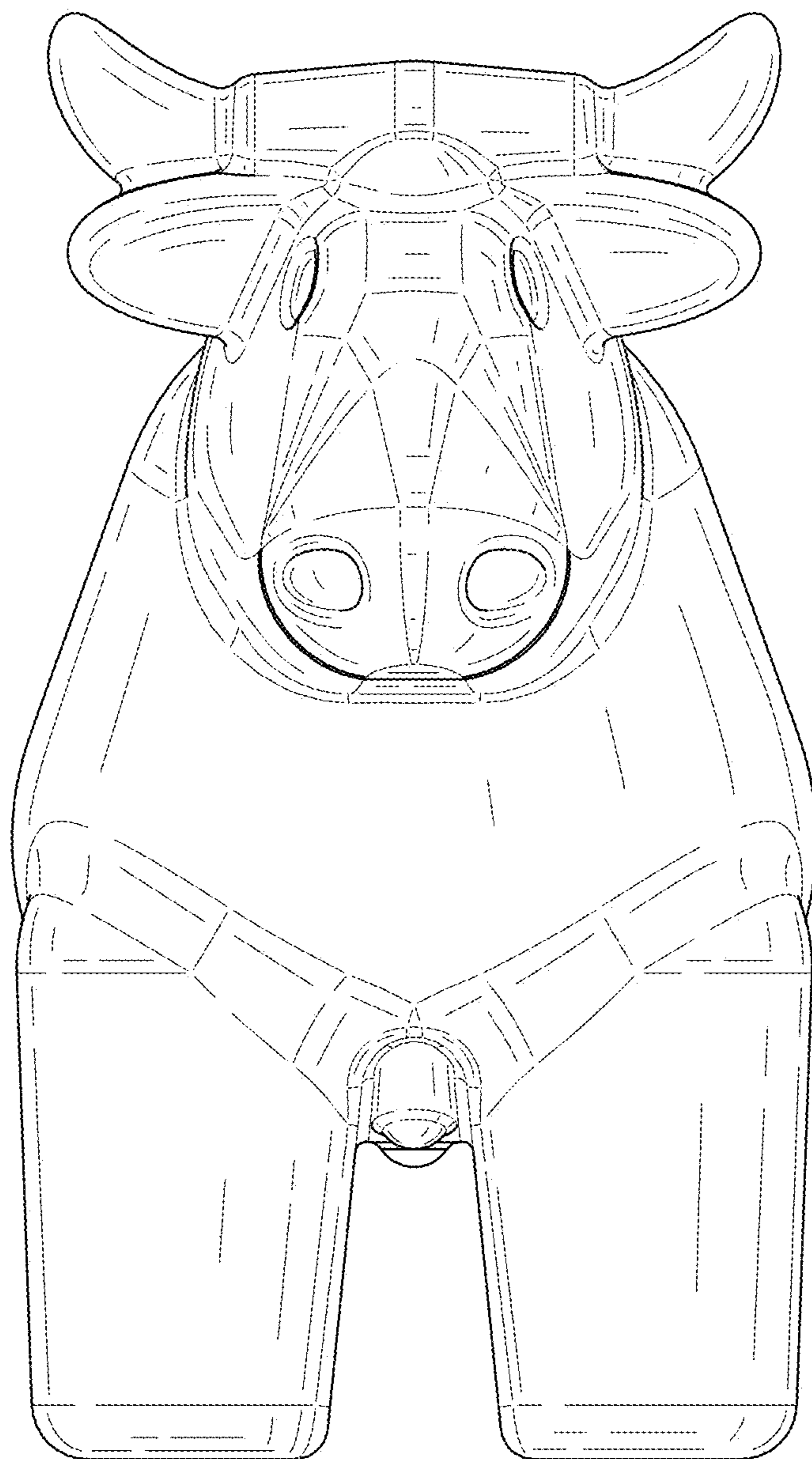

FIG. 11

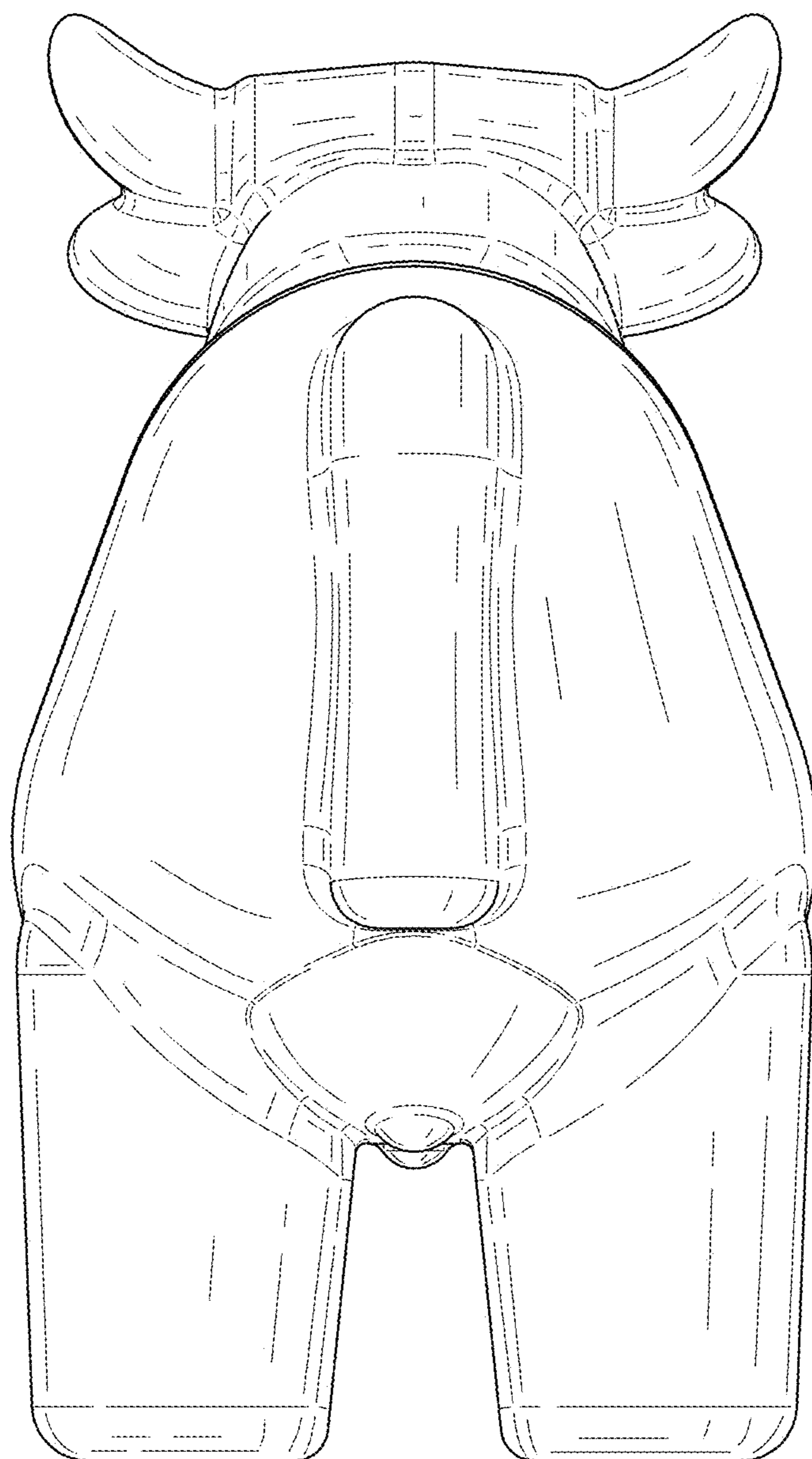

FIG. 12

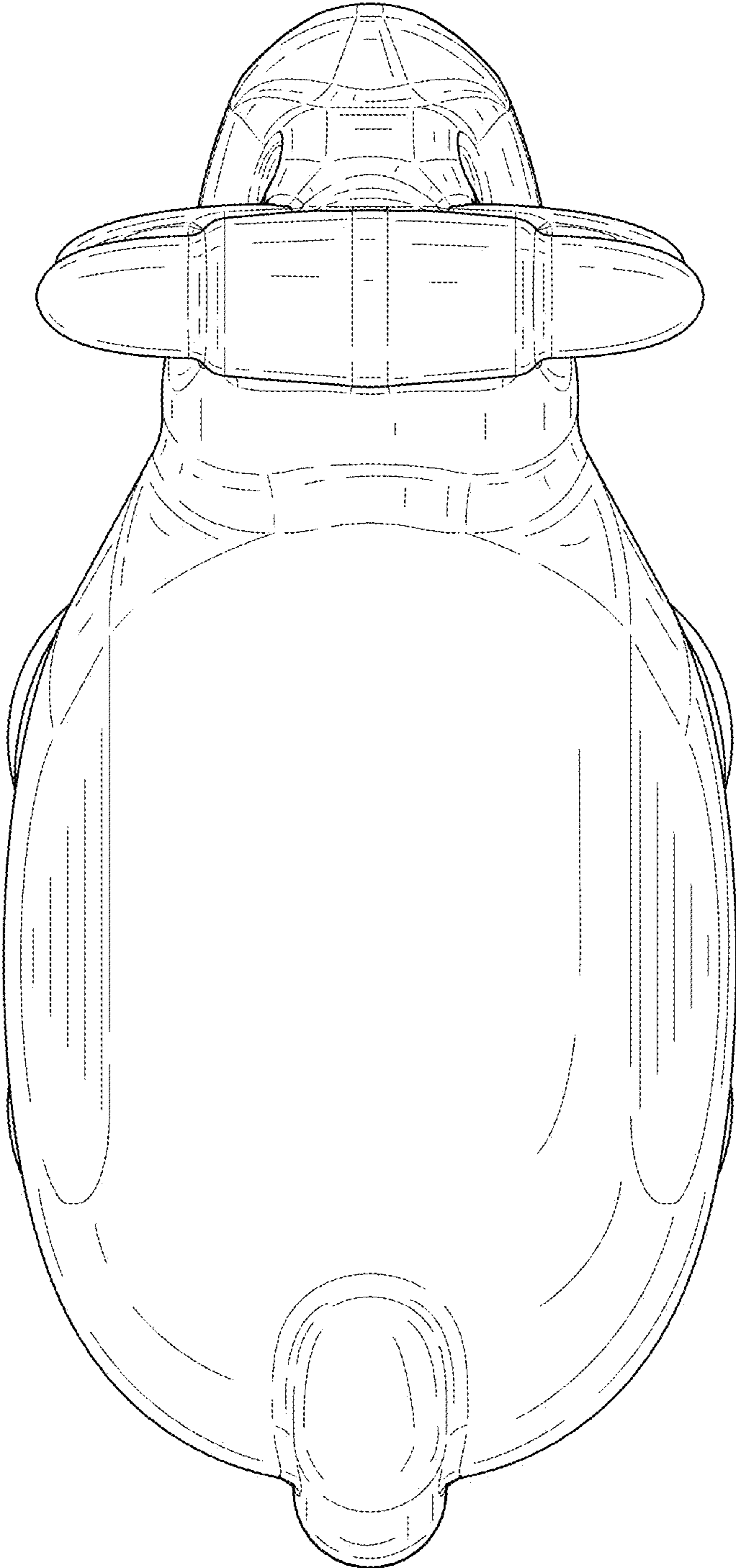

FIG. 13

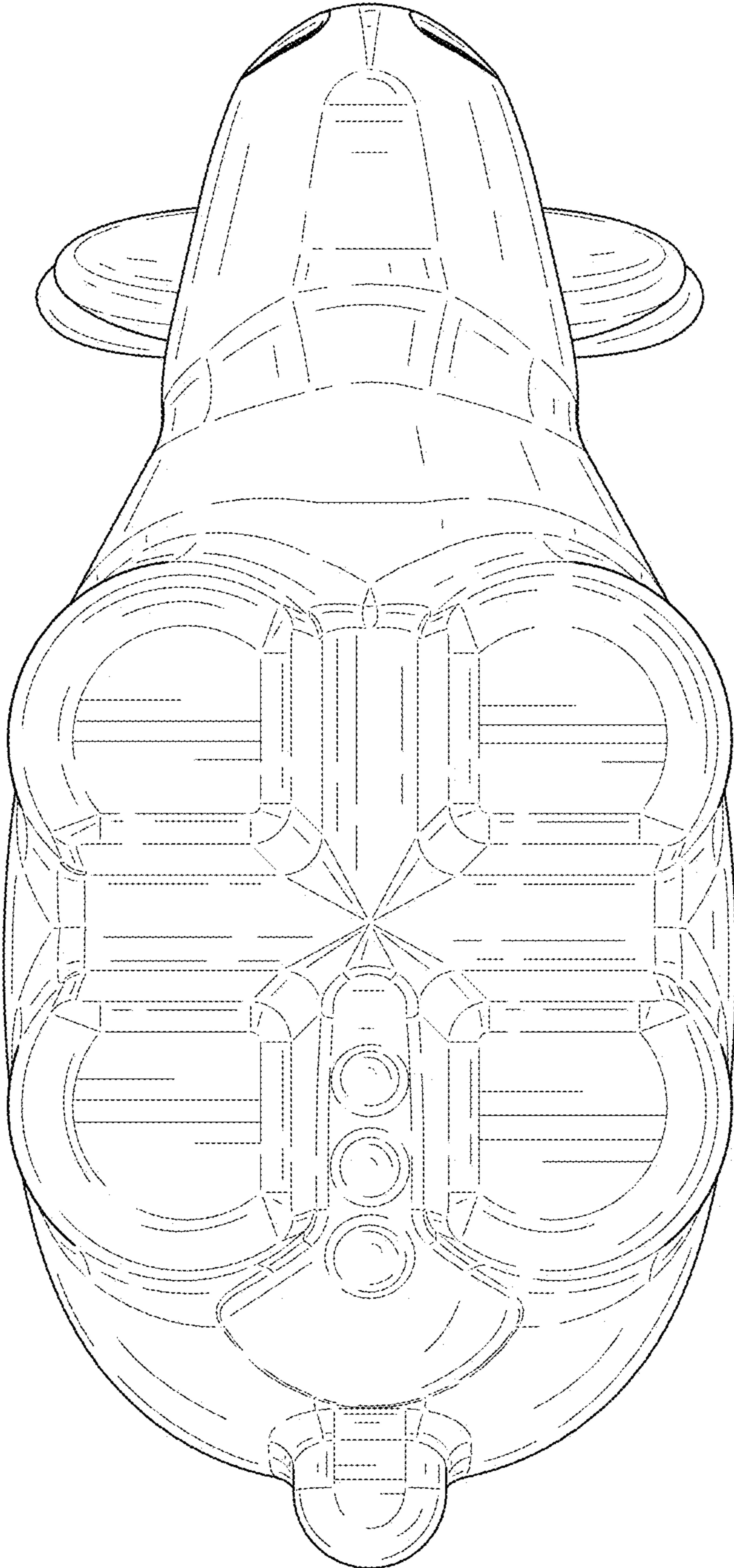

FIG. 14

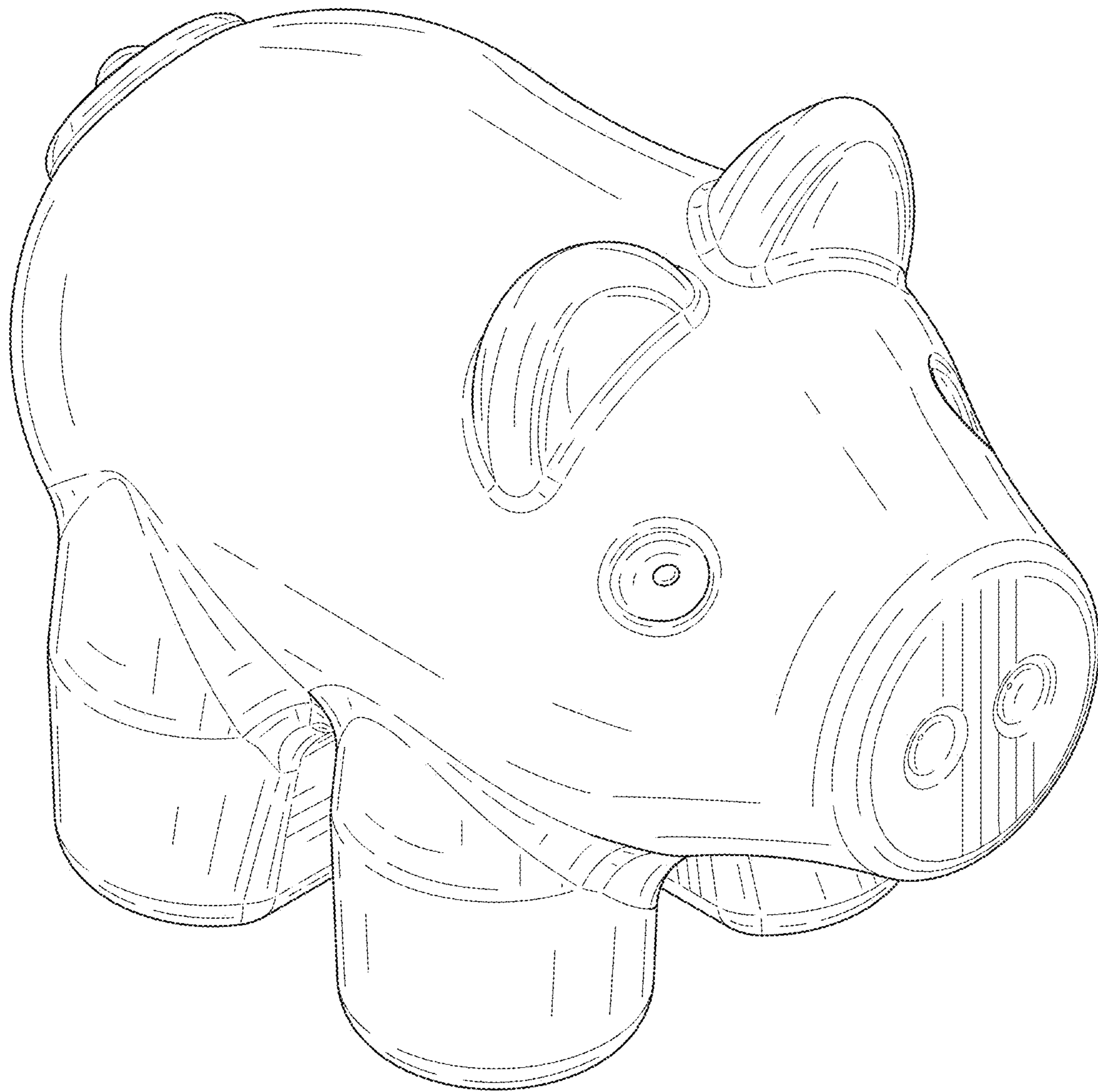

FIG. 15



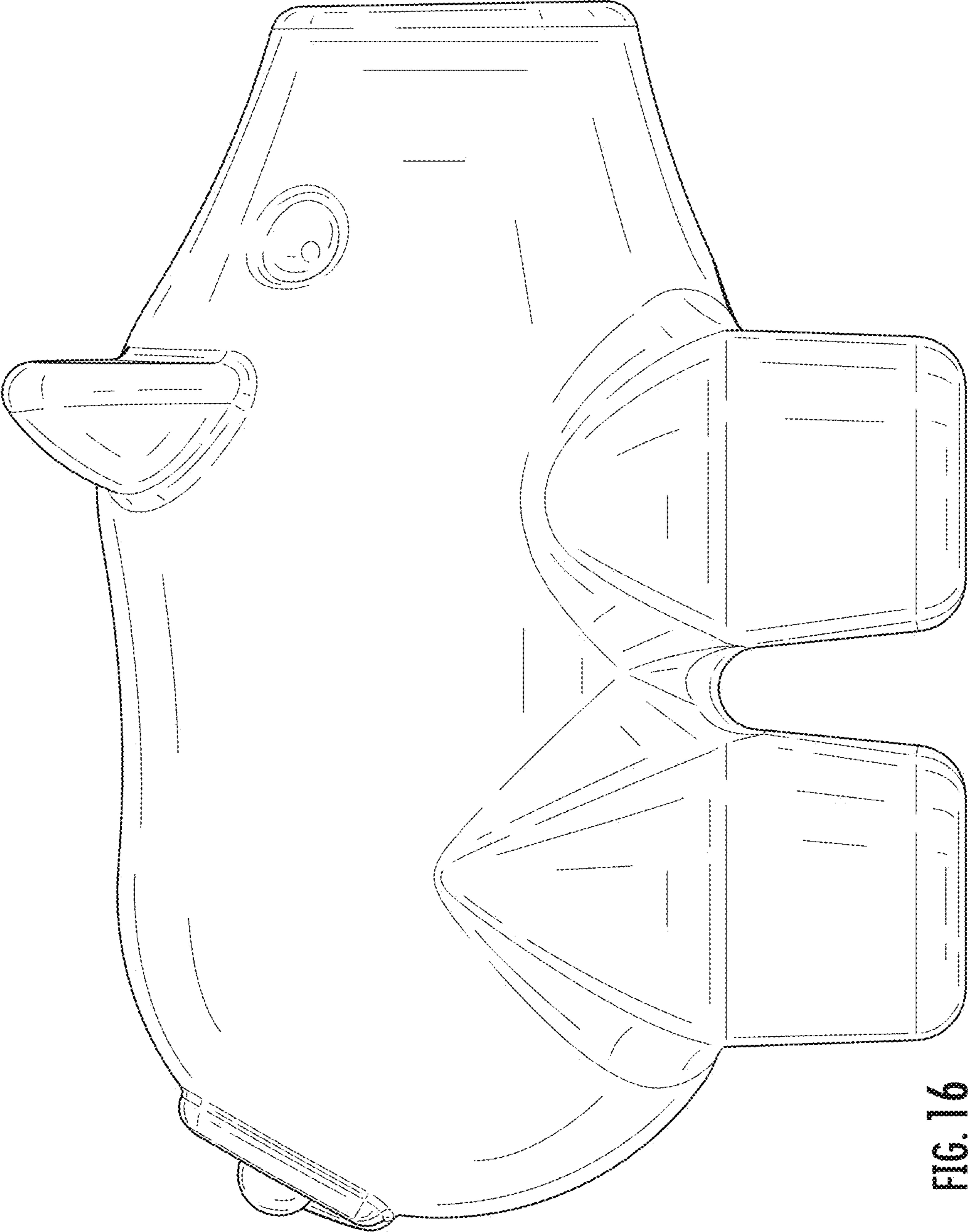

FIG. 16

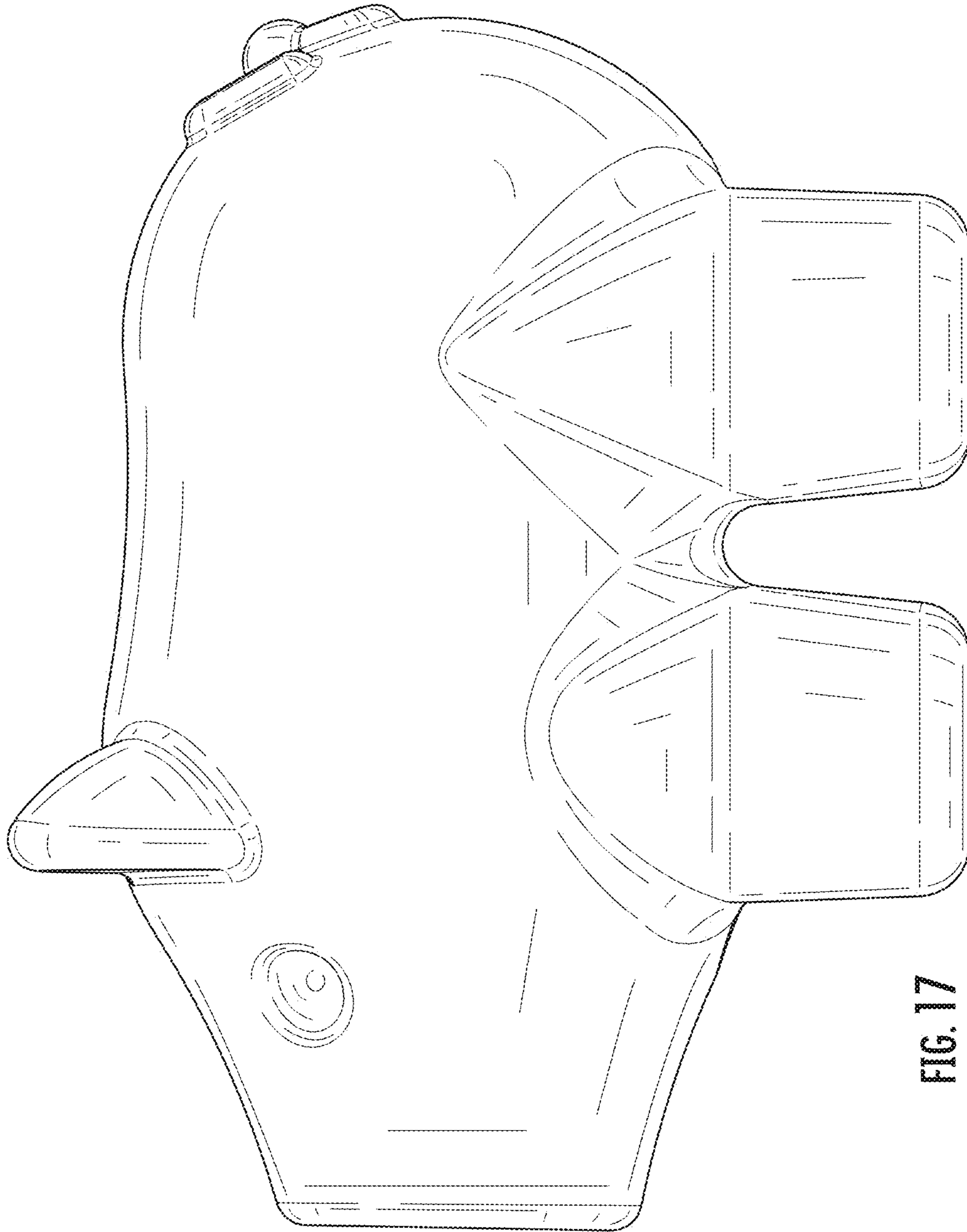

FIG. 17

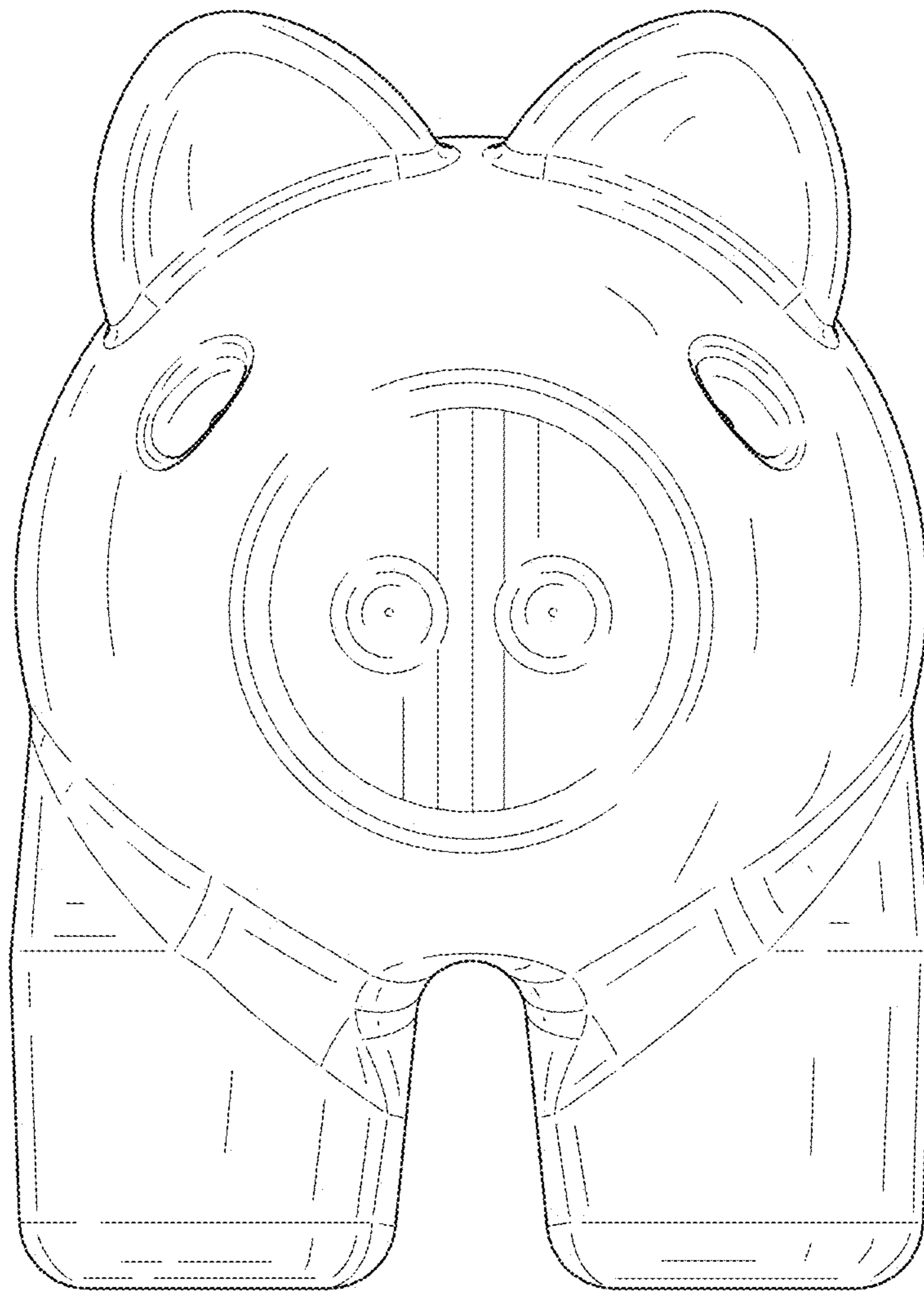

FIG. 18

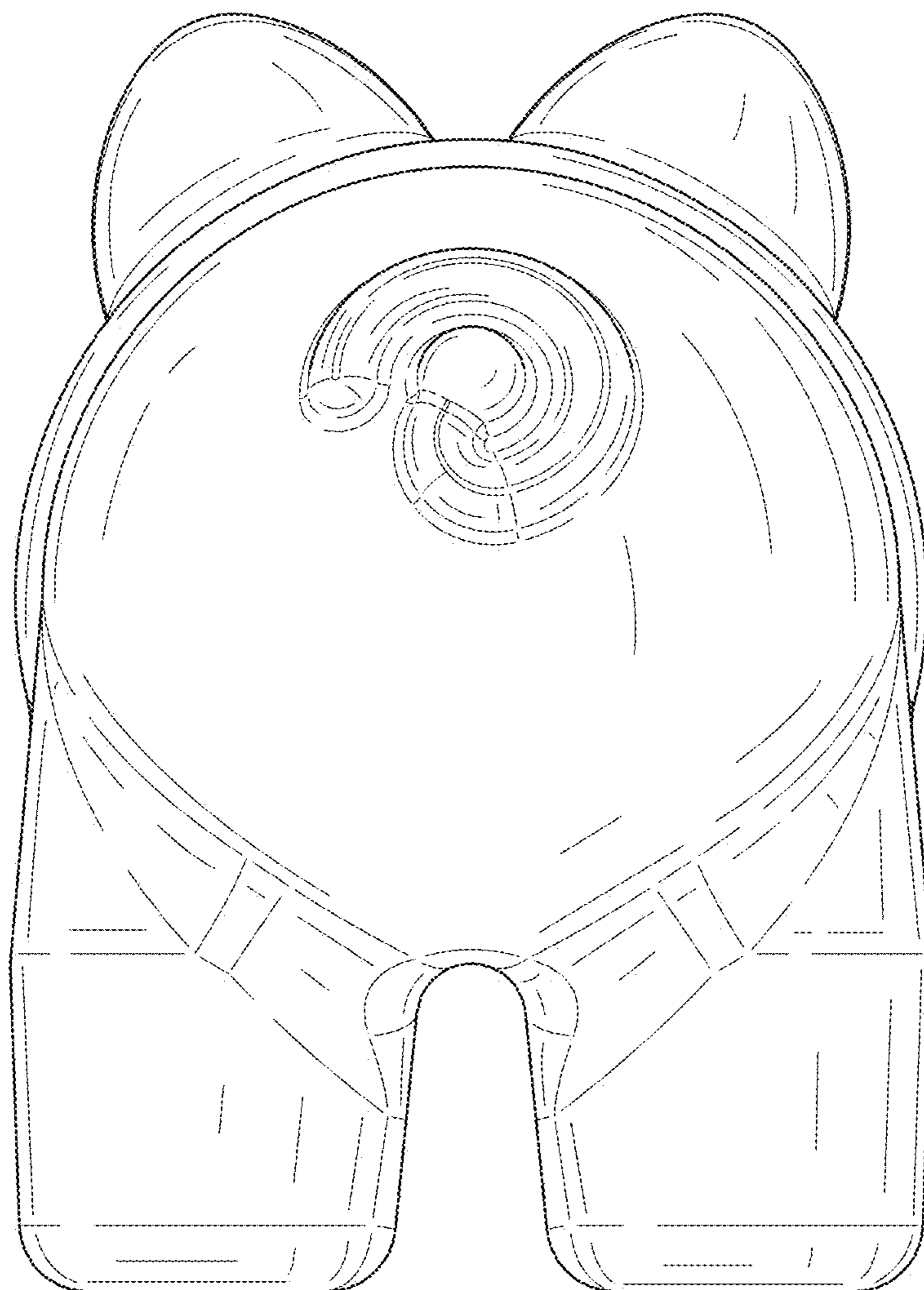

FIG. 19



FIG. 20

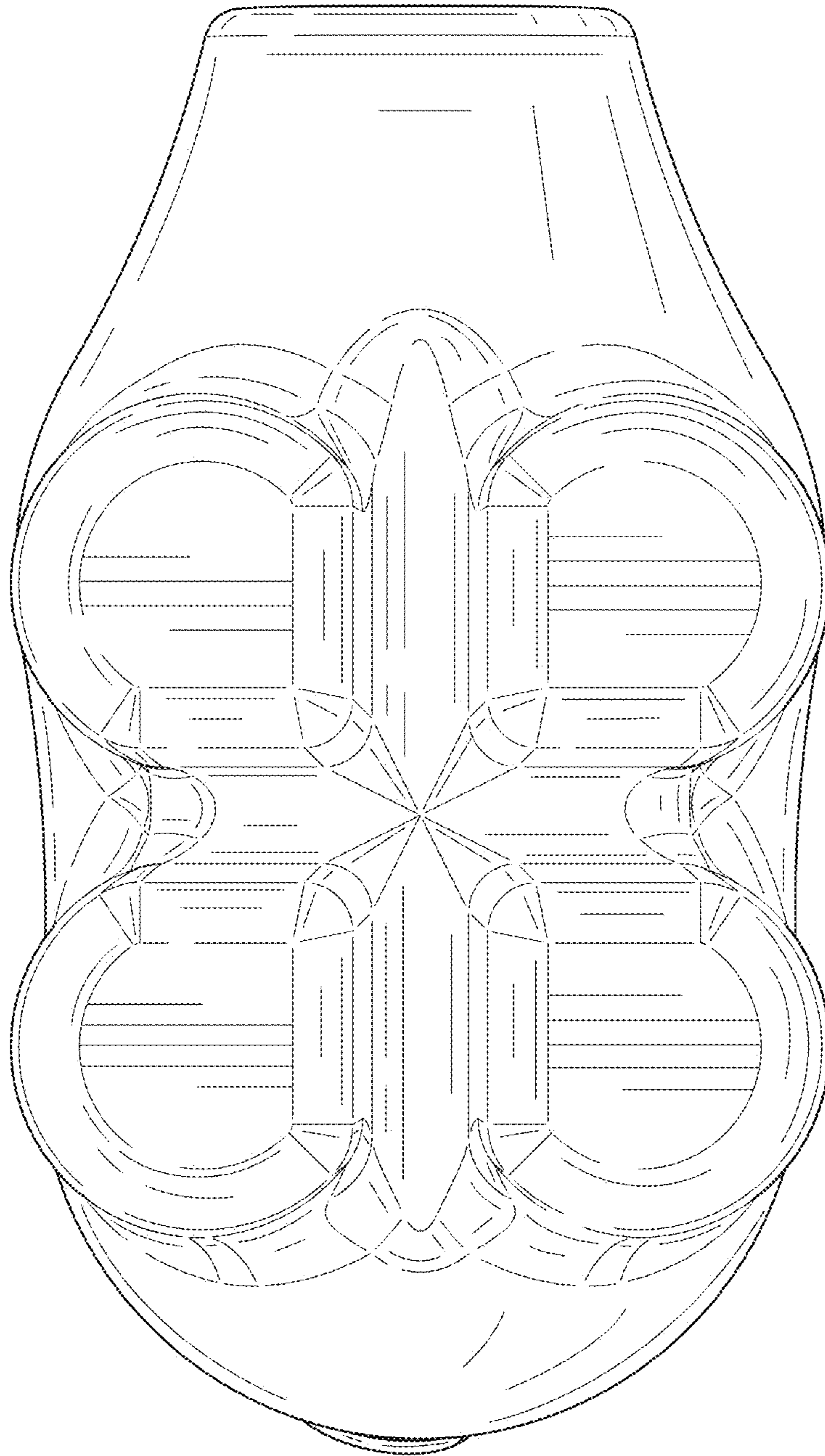

FIG. 21

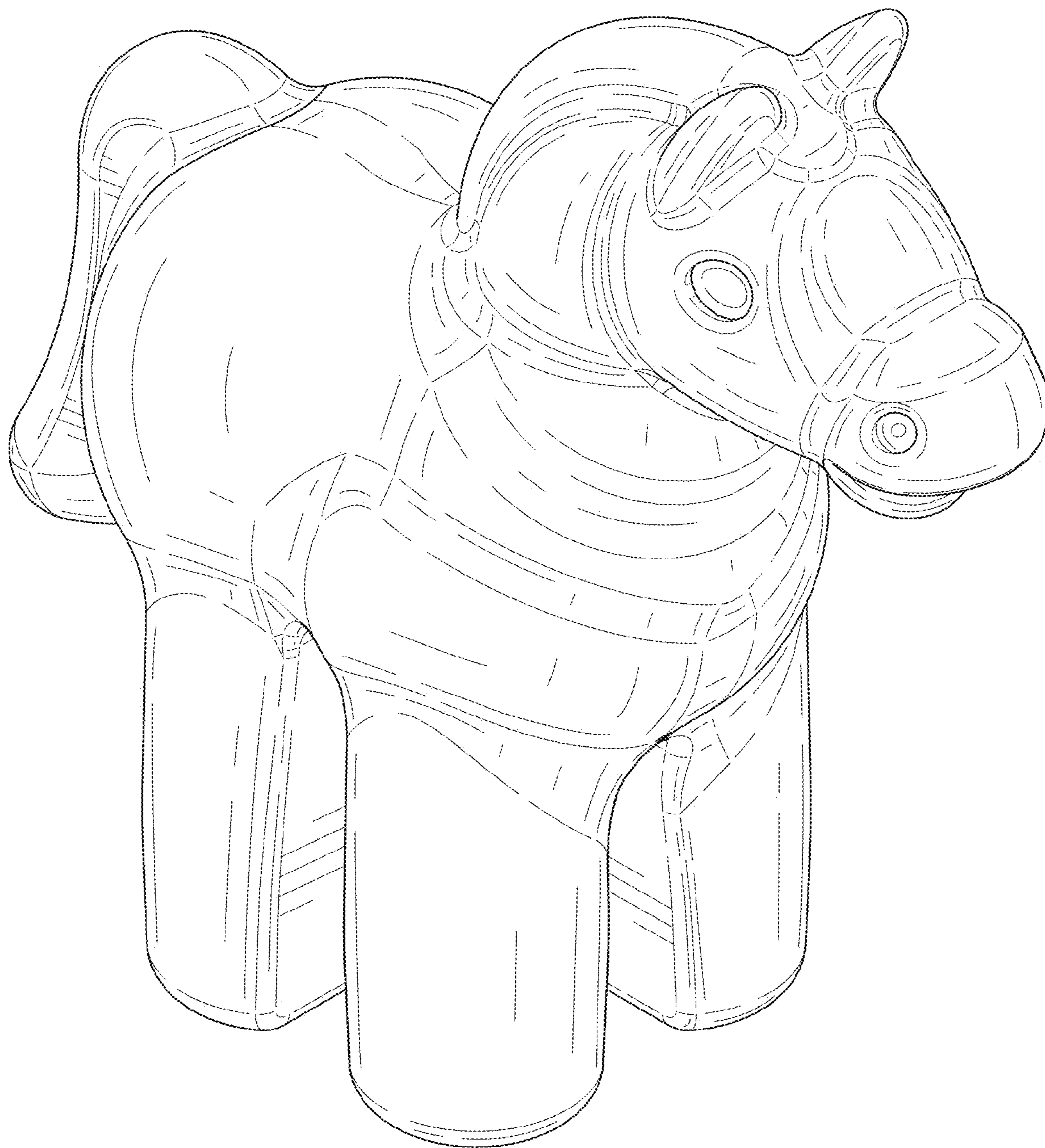

FIG. 22

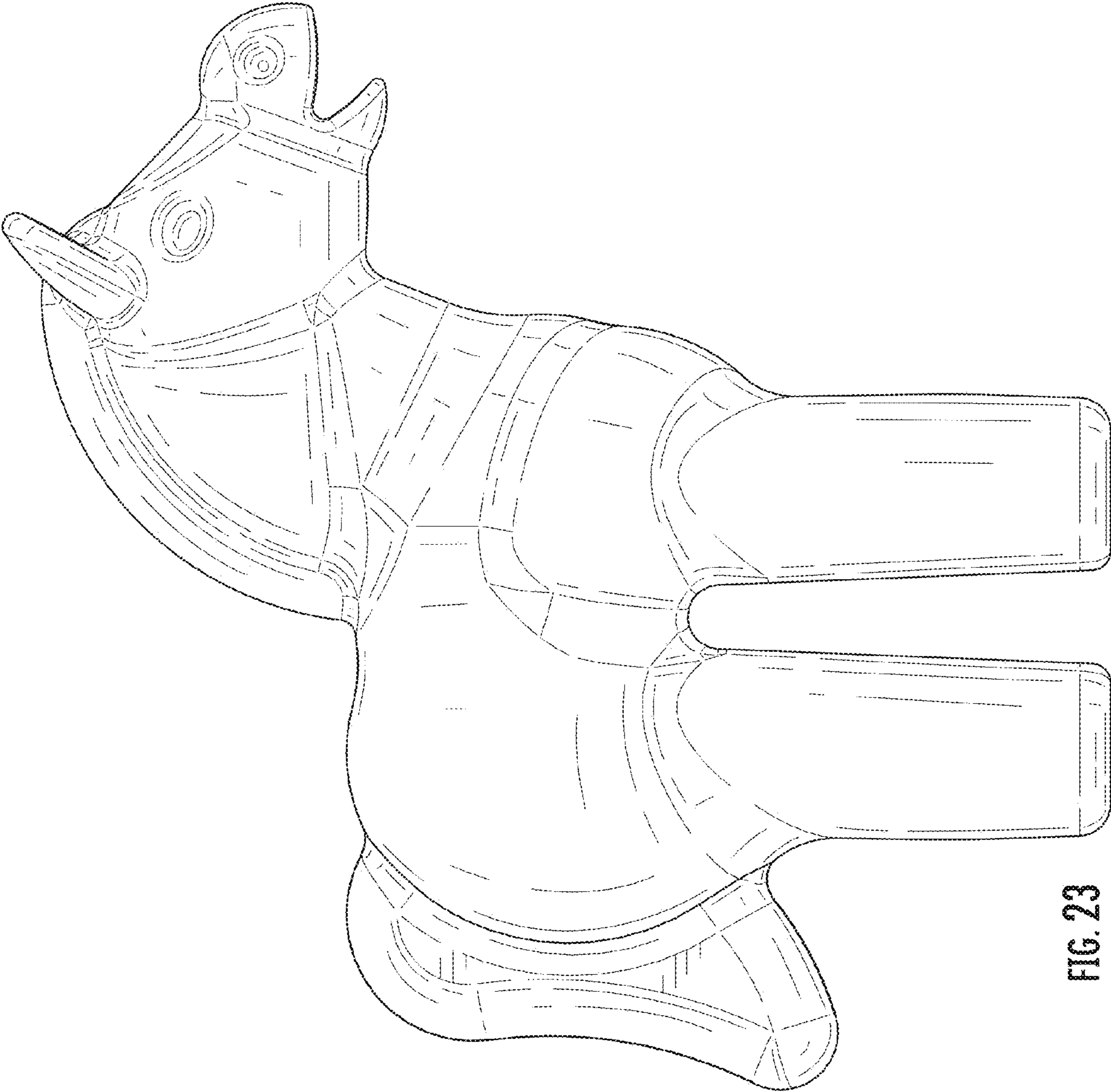

FIG. 23



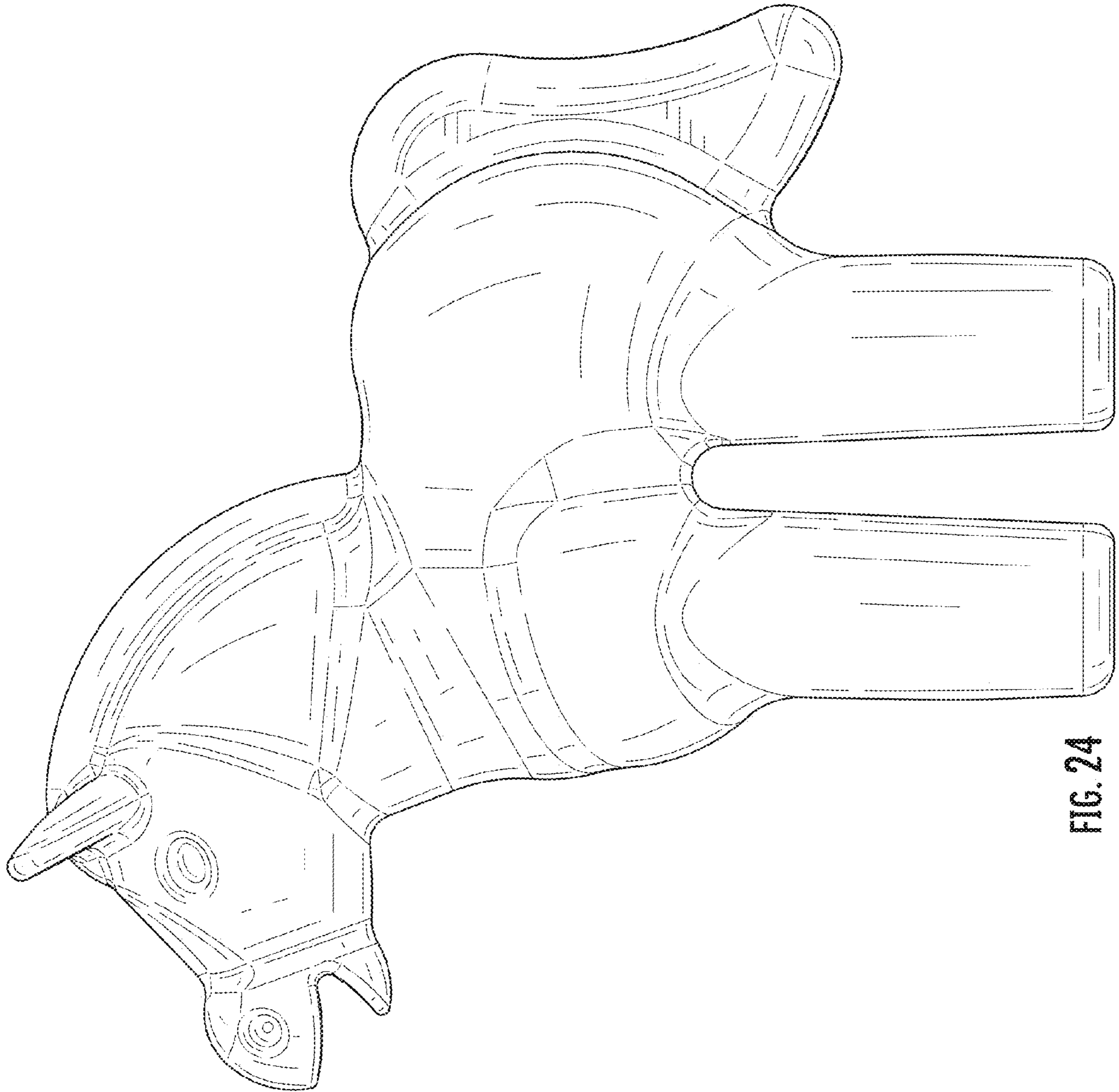

FIG. 24

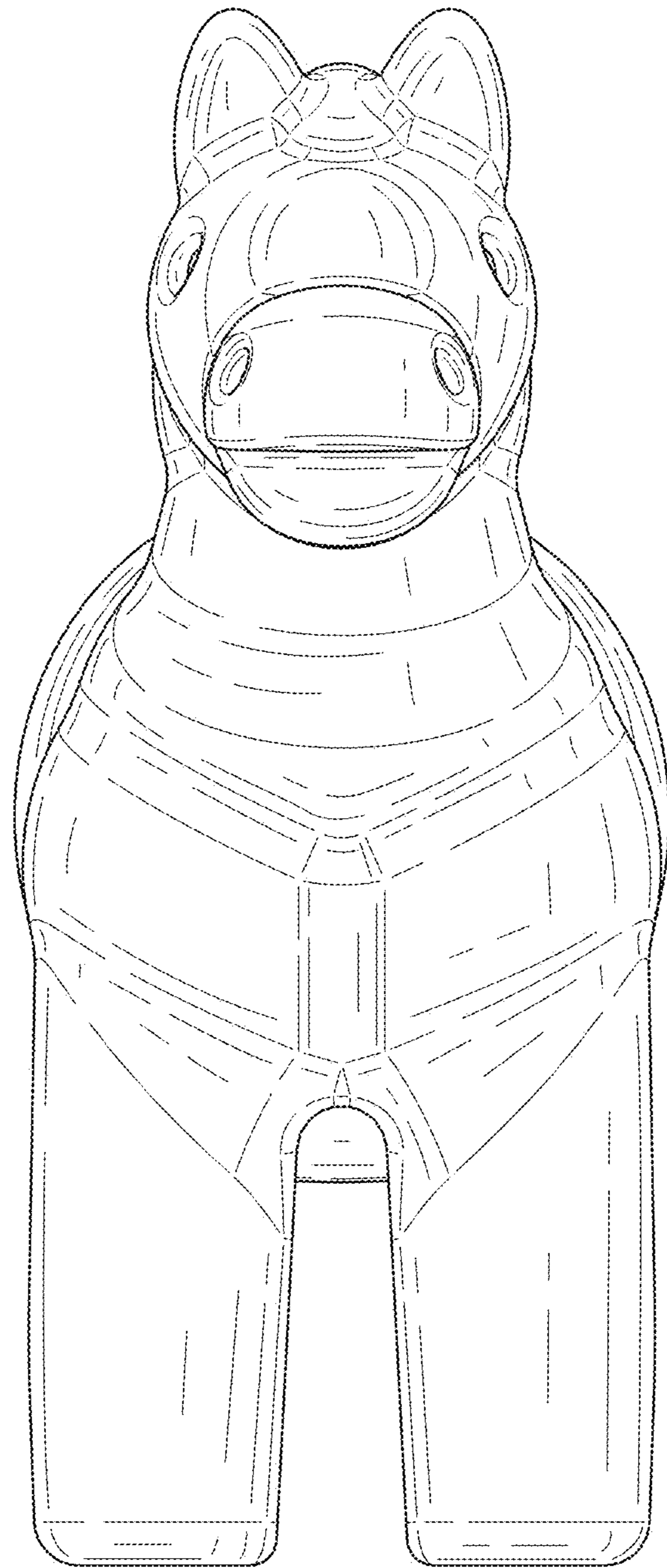

FIG. 25

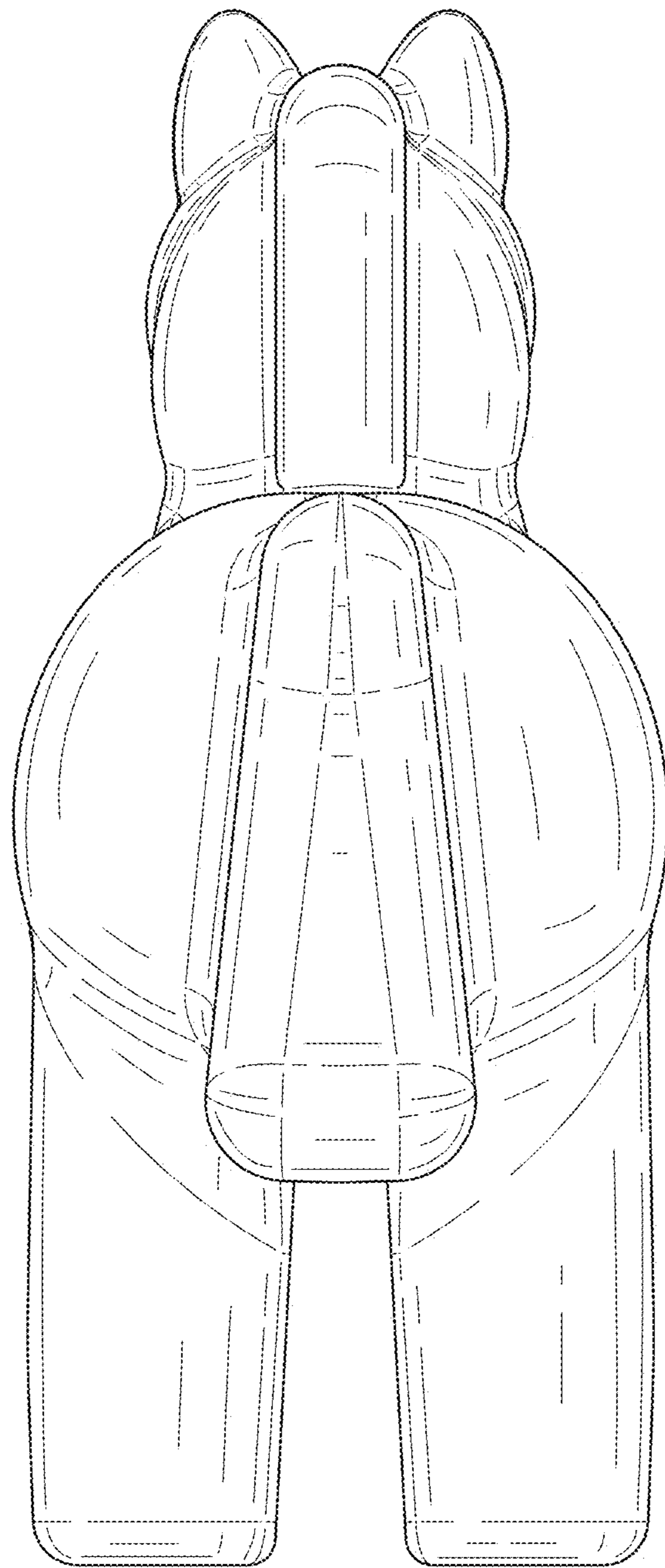

FIG. 26

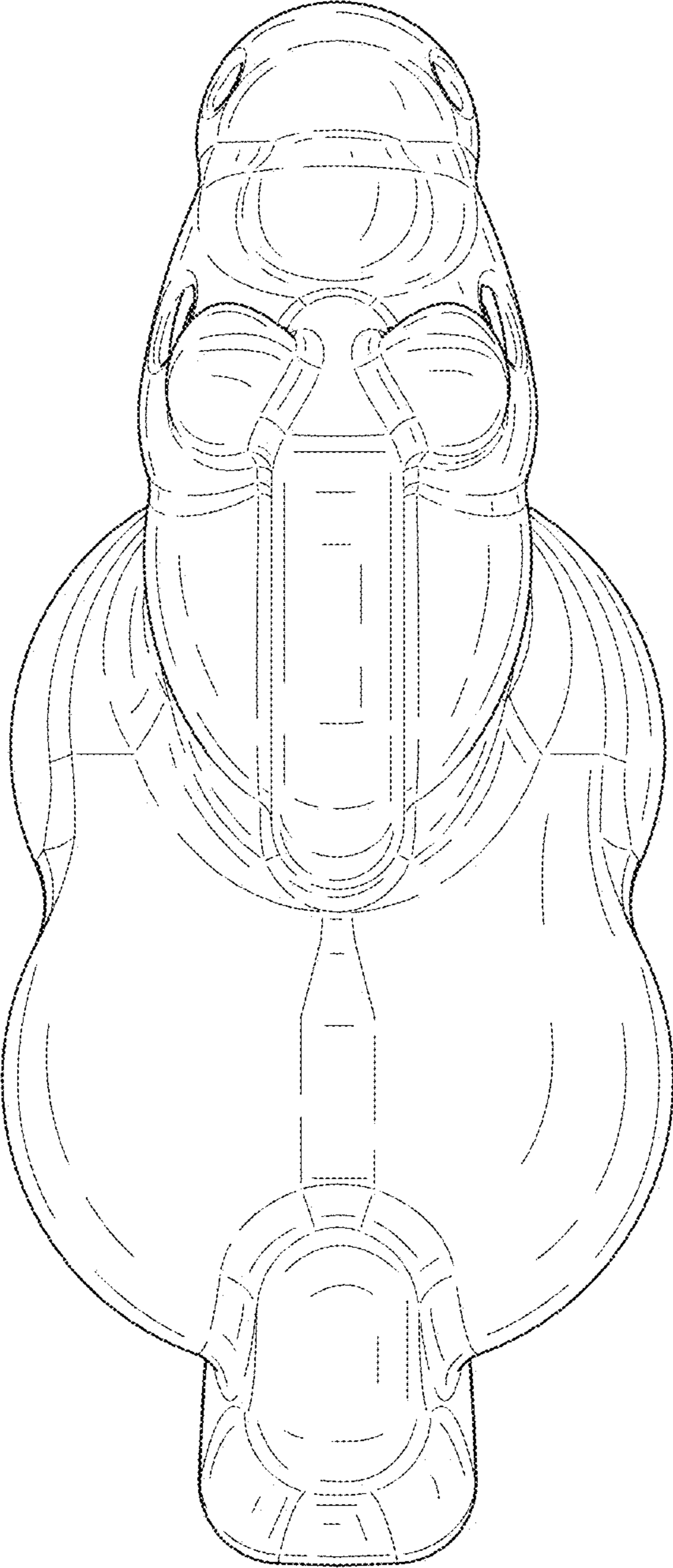

FIG. 27

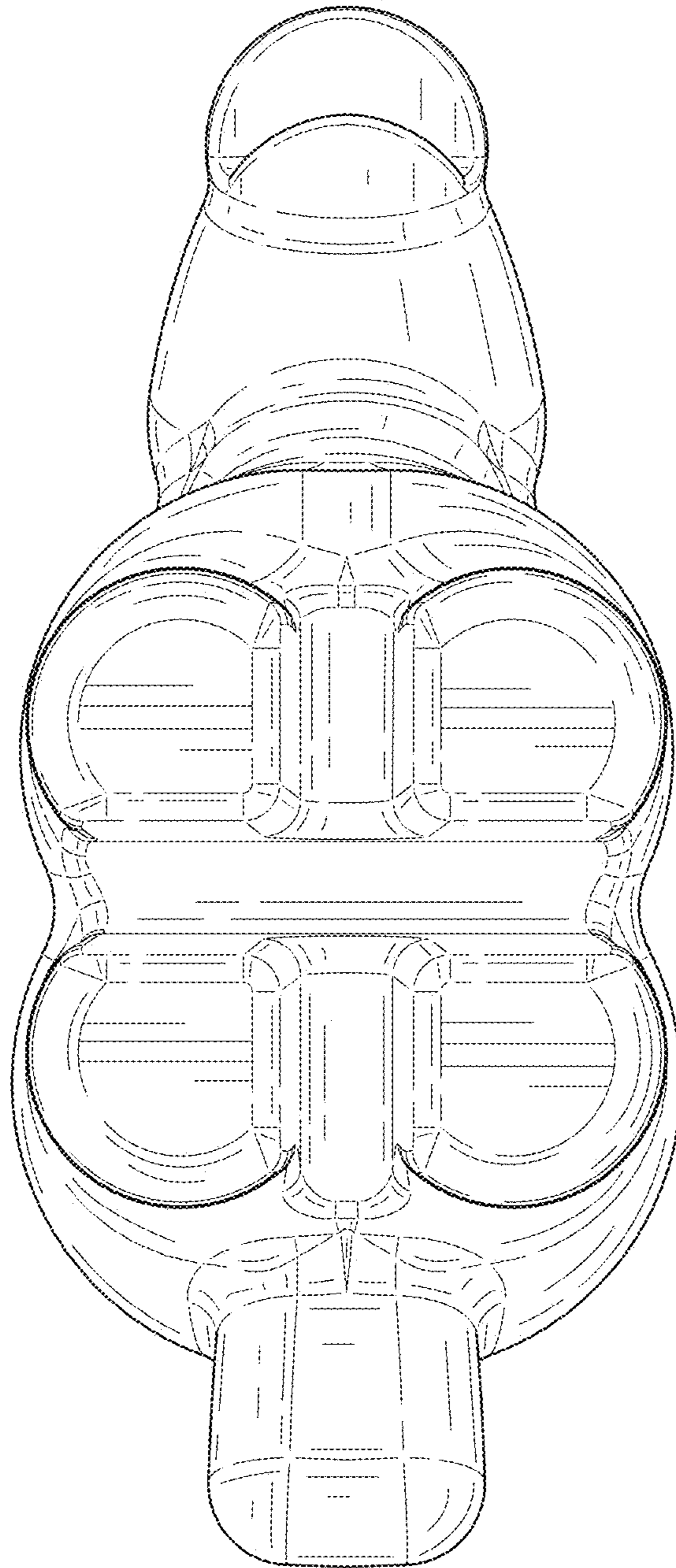

FIG. 28

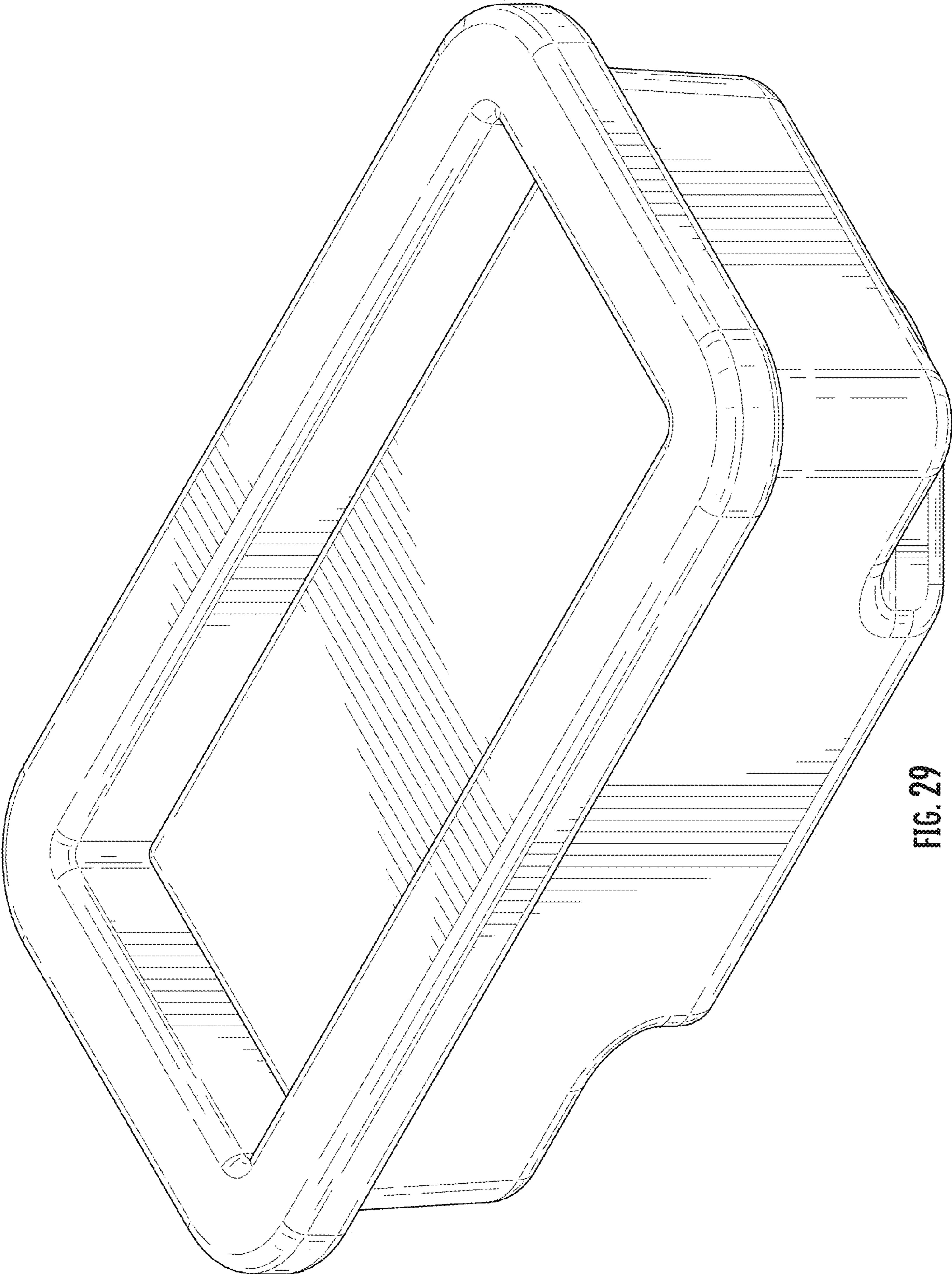

FIG. 29

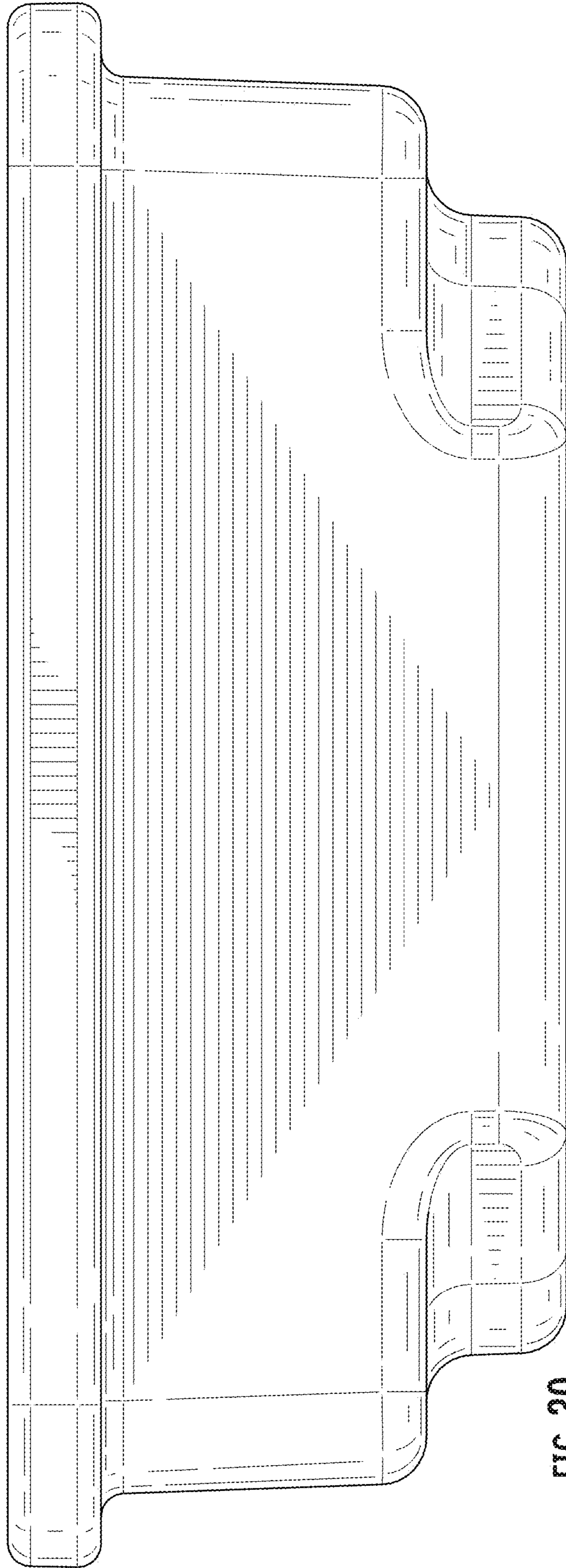

FIG. 30

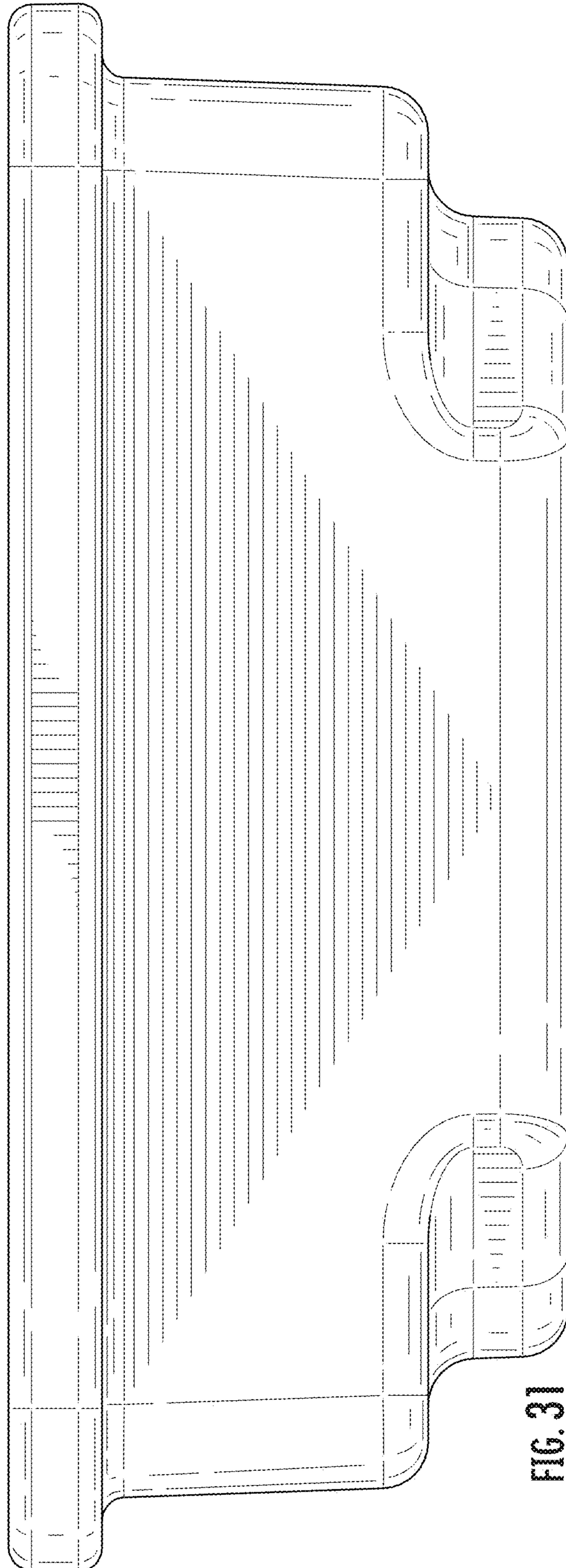

FIG. 31



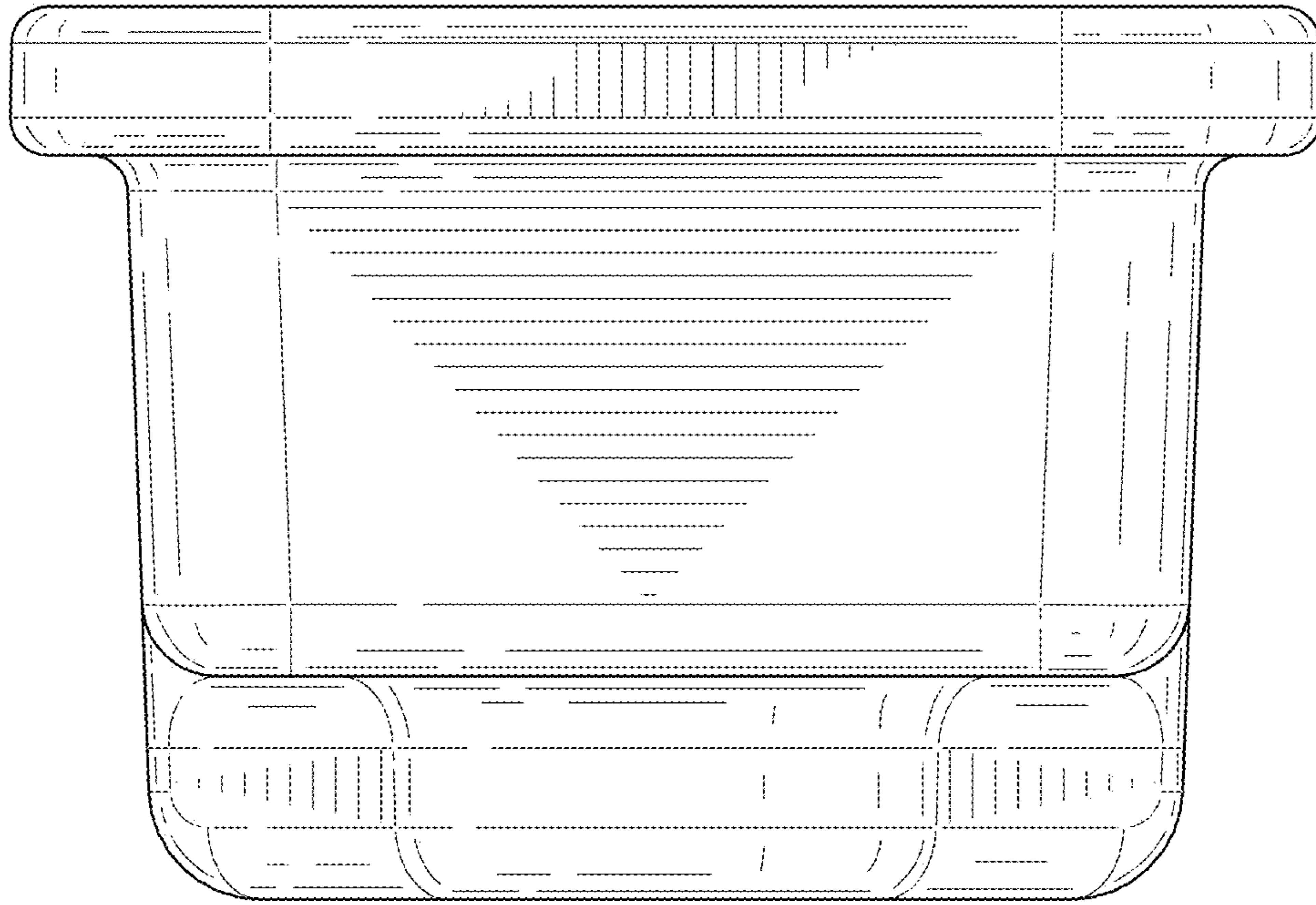

FIG. 32

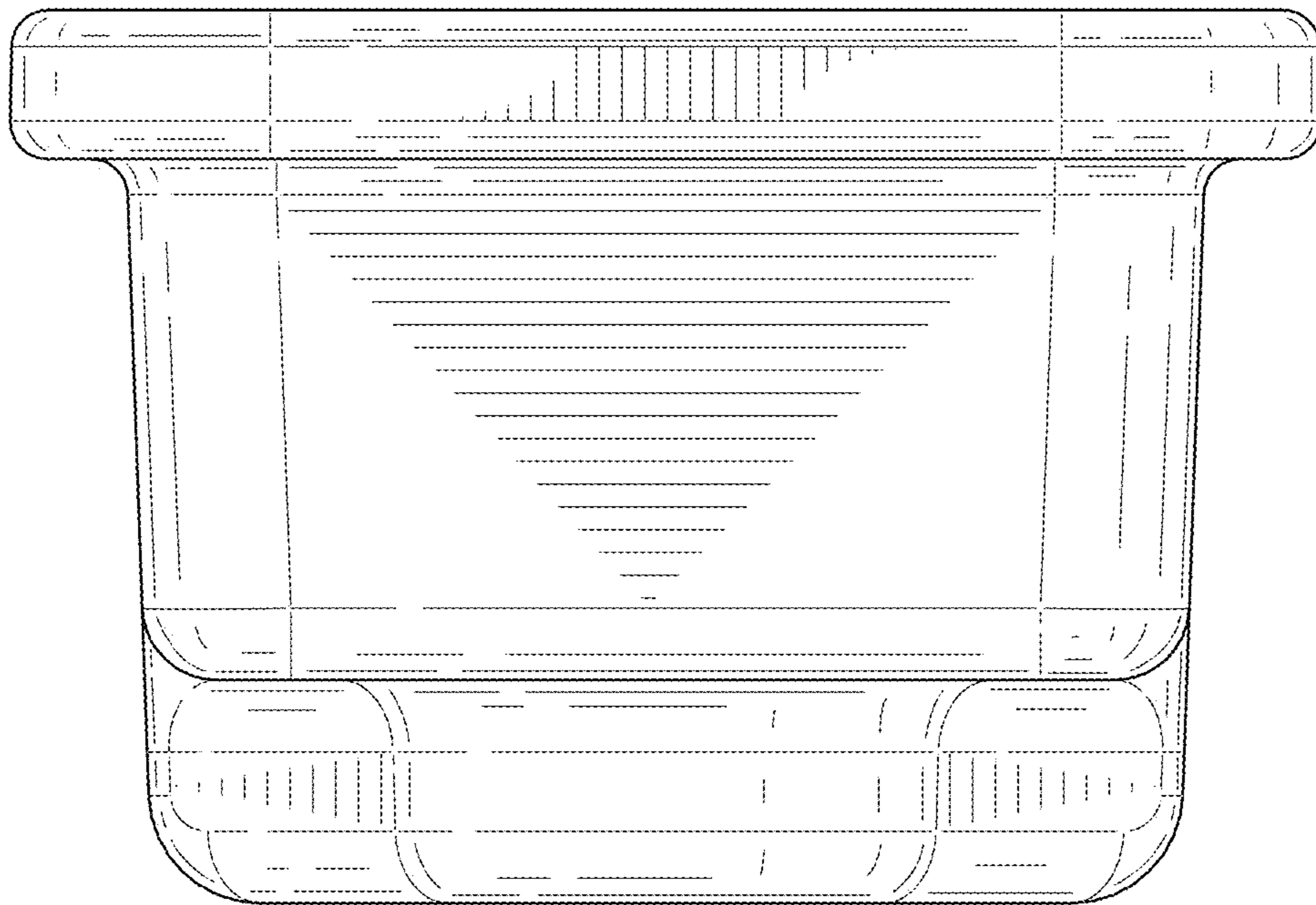

FIG. 33

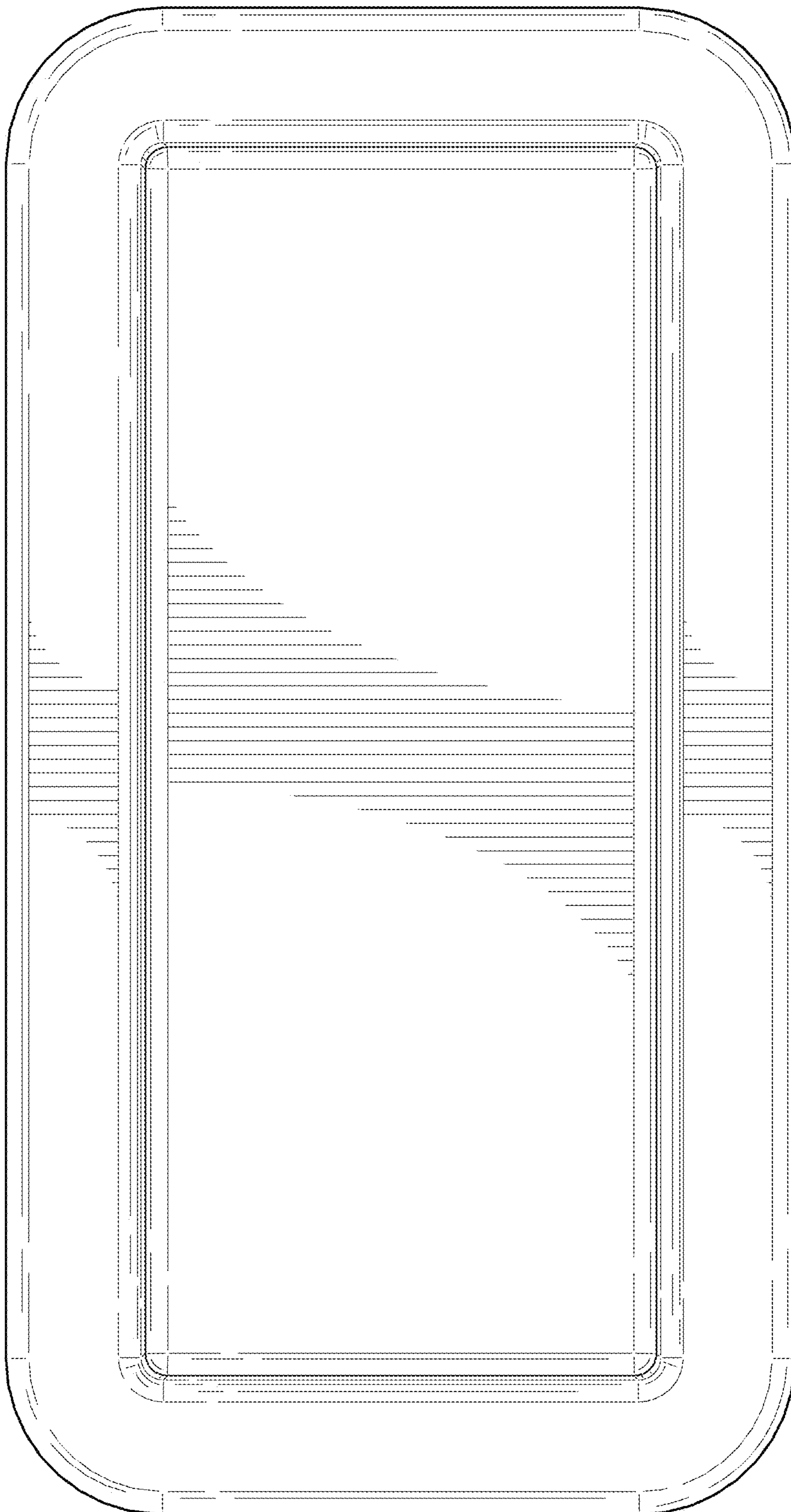

FIG. 34

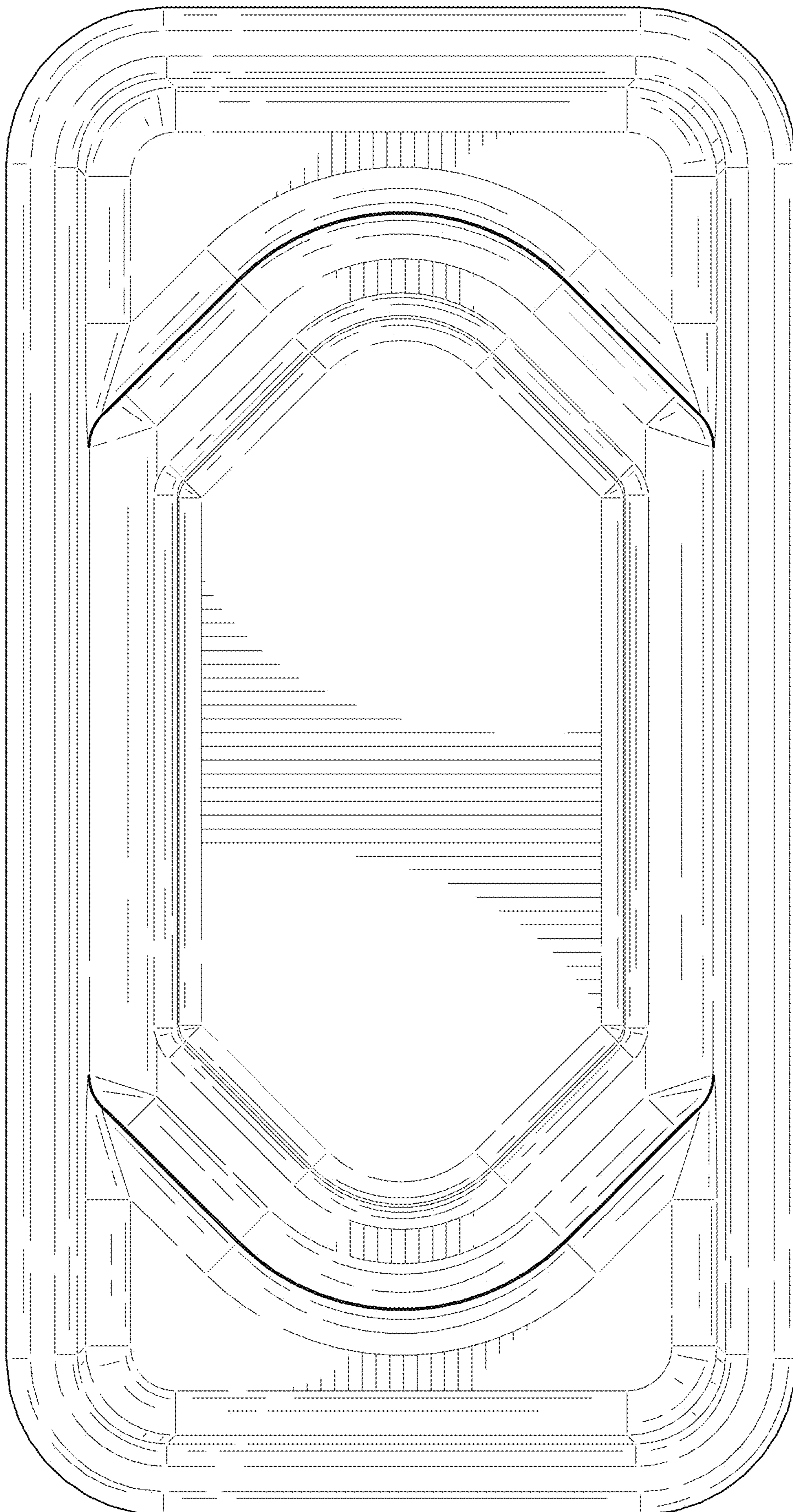

FIG. 35

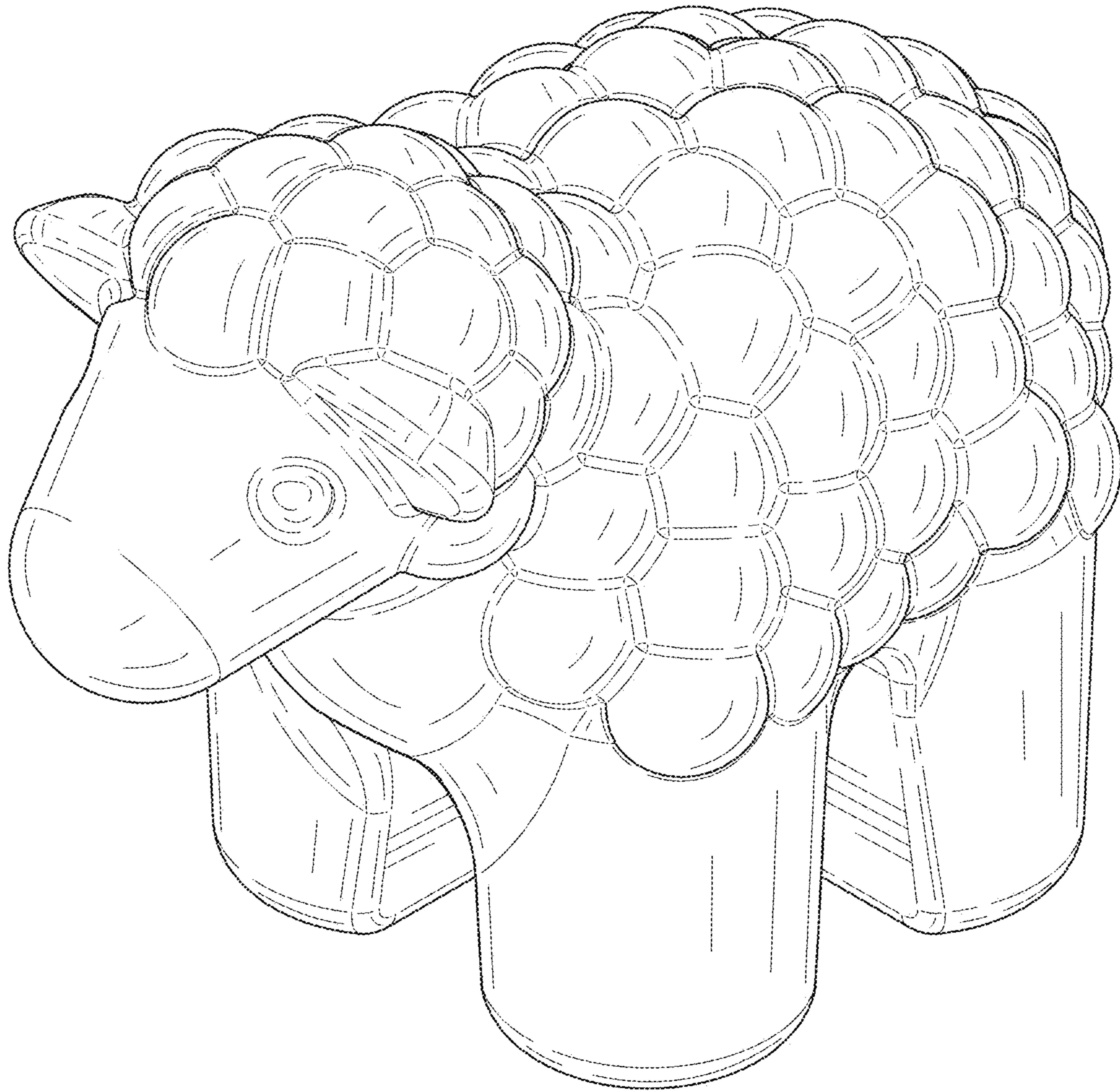

FIG. 36

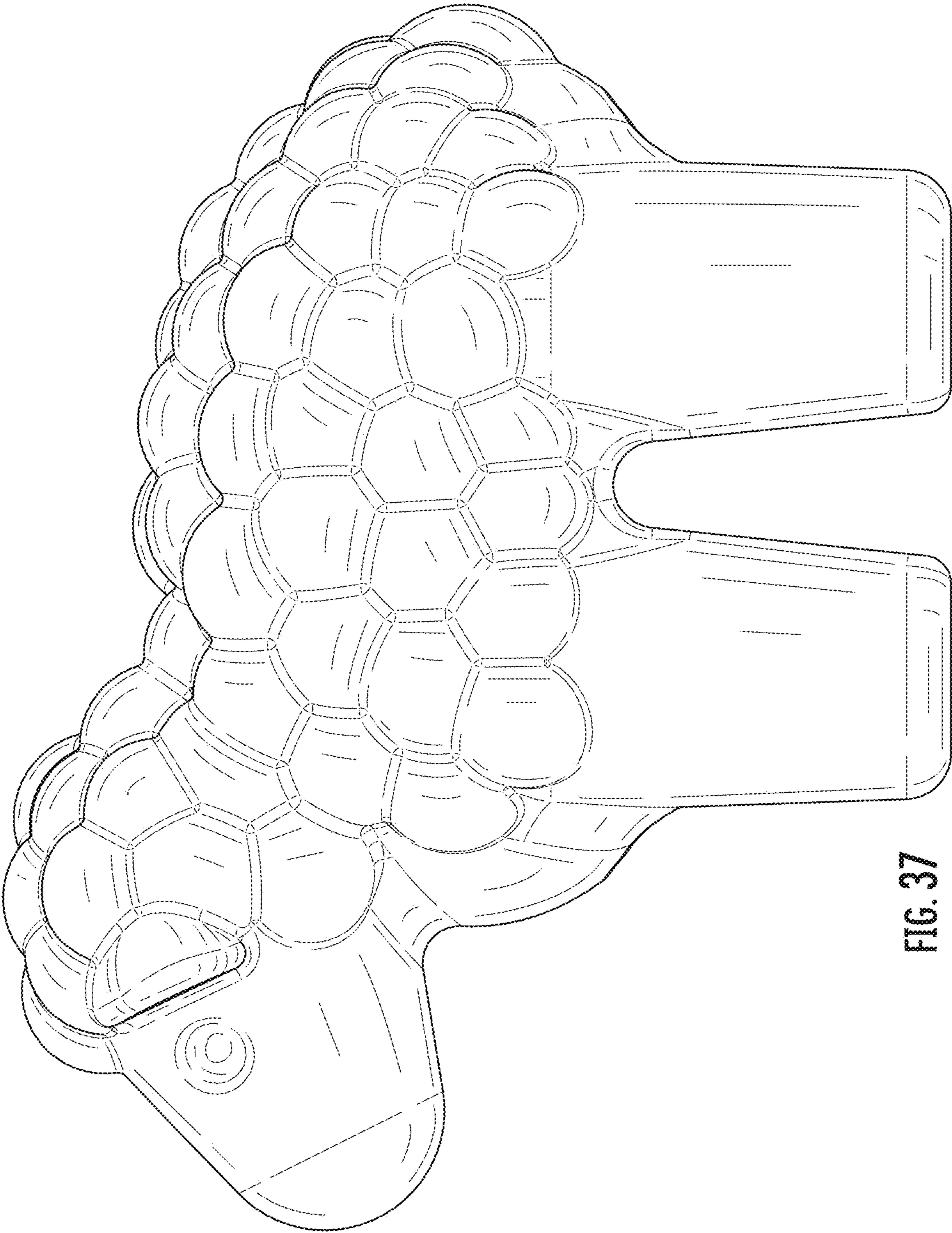

FIG. 37

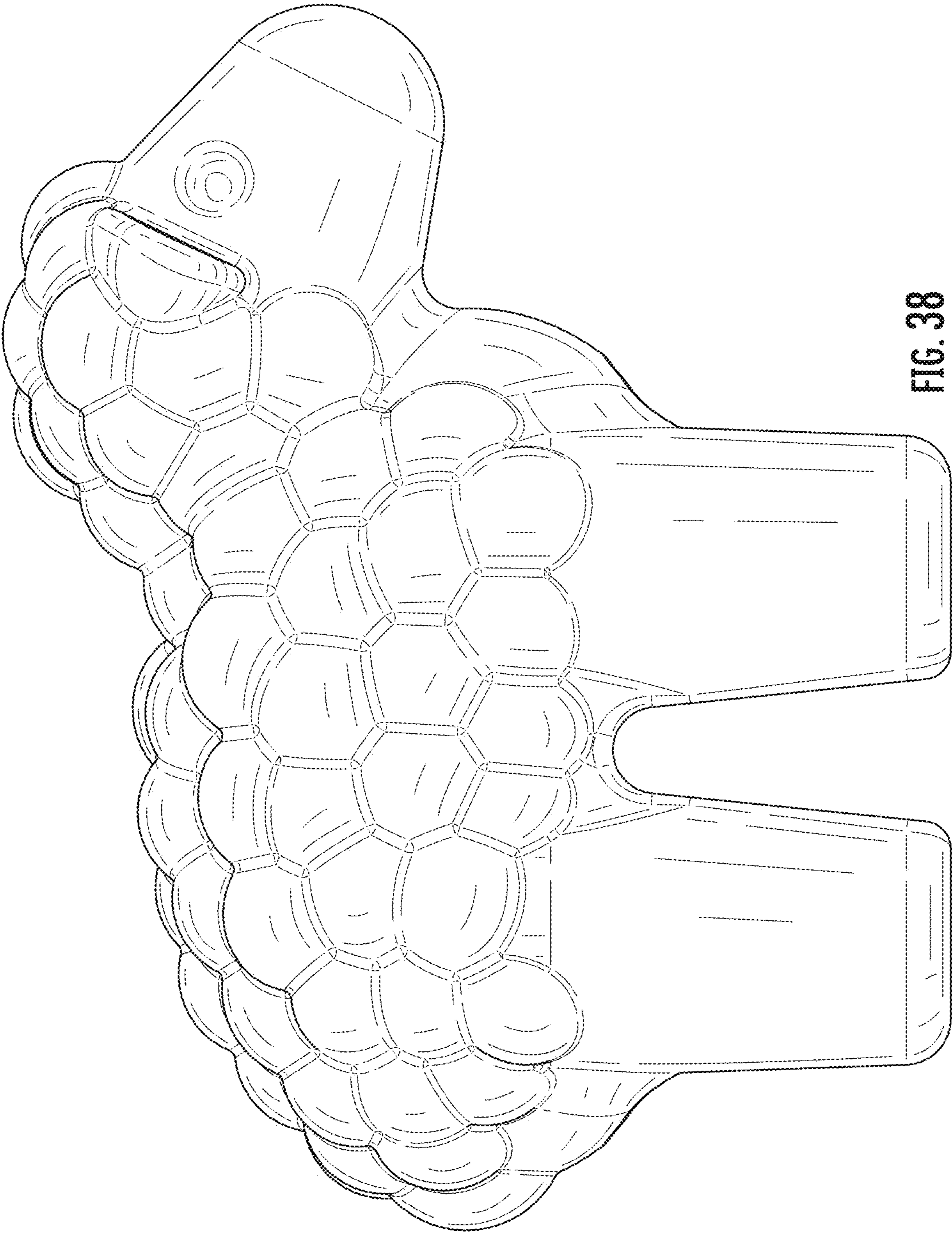

FIG. 38

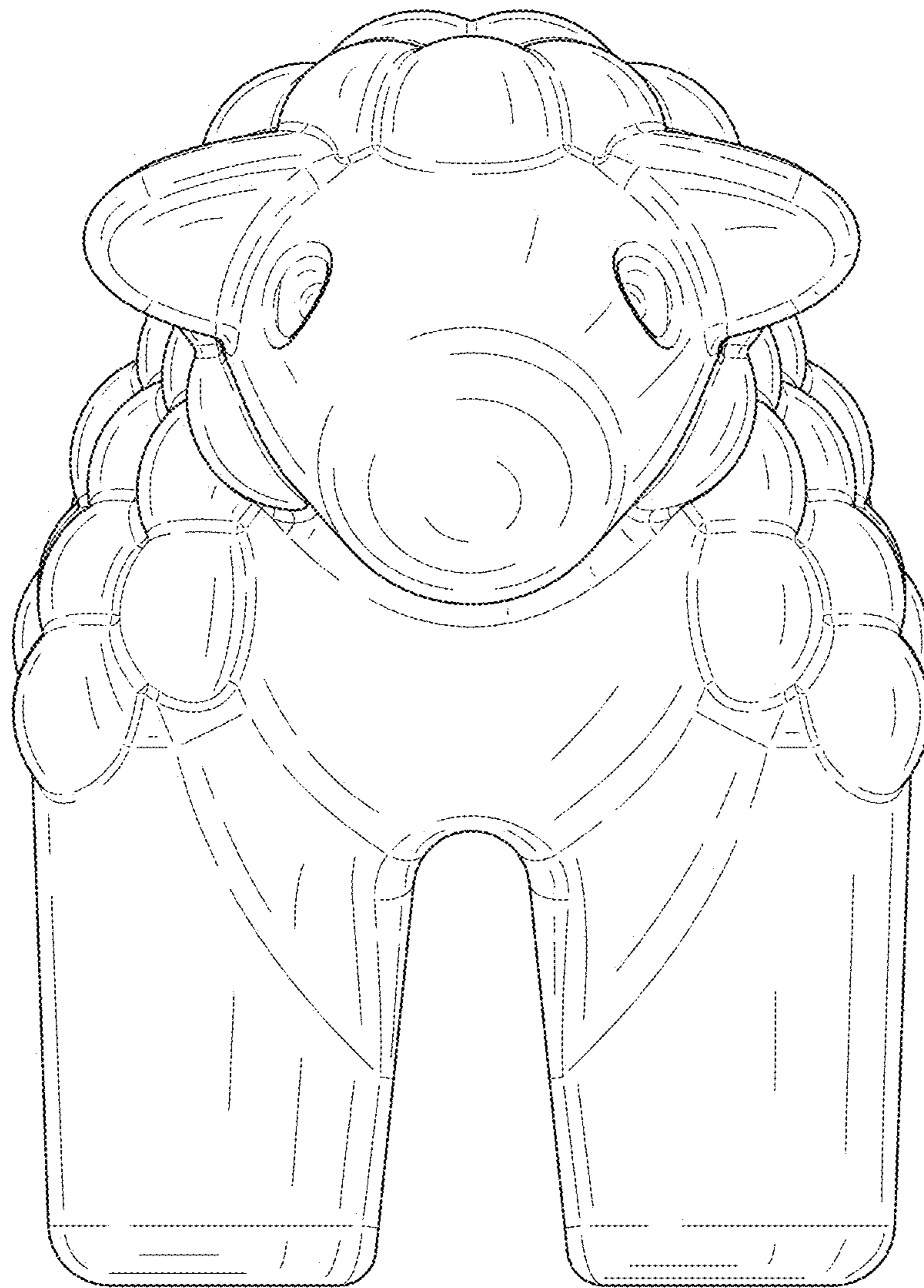

FIG. 39

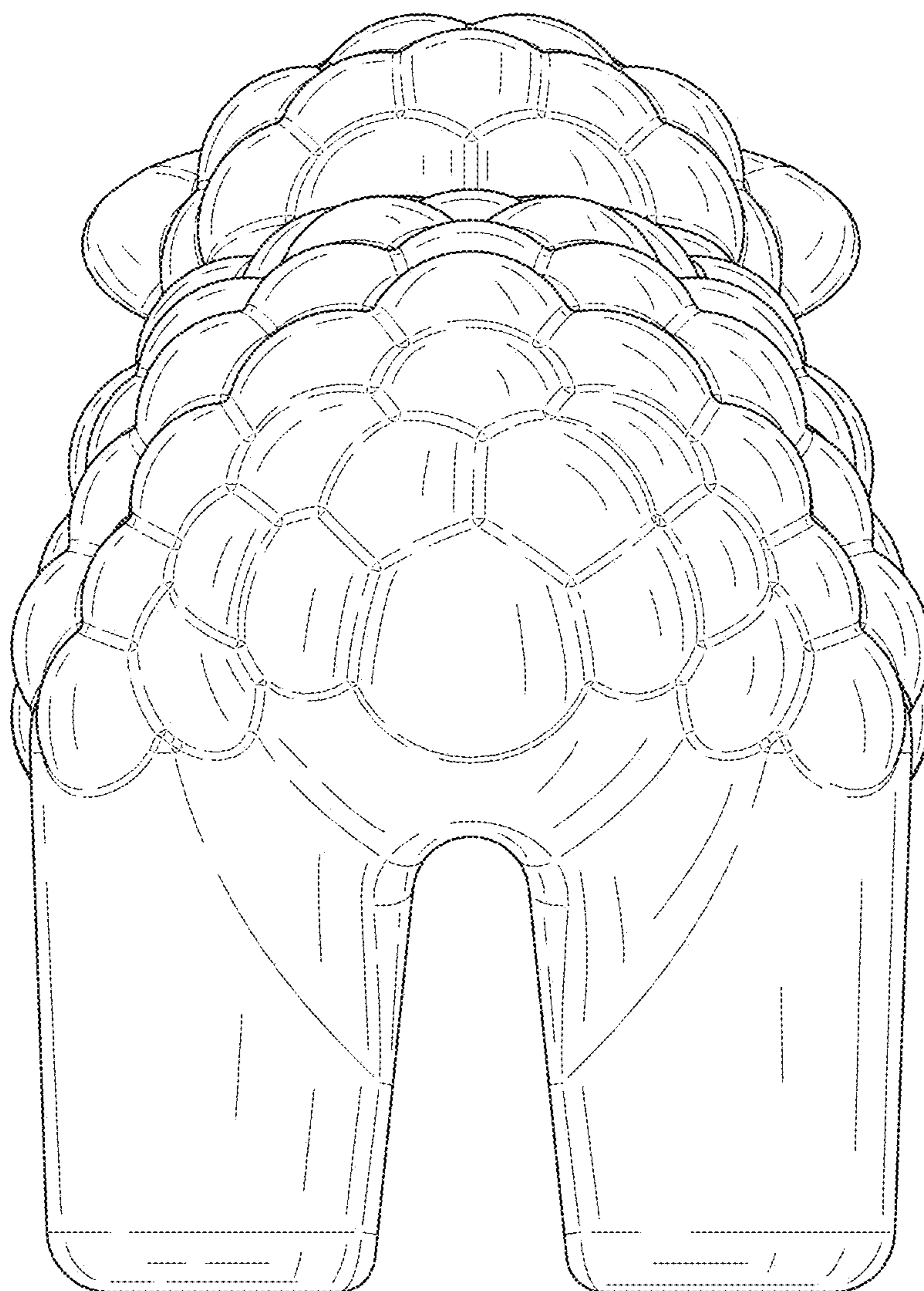

FIG. 40



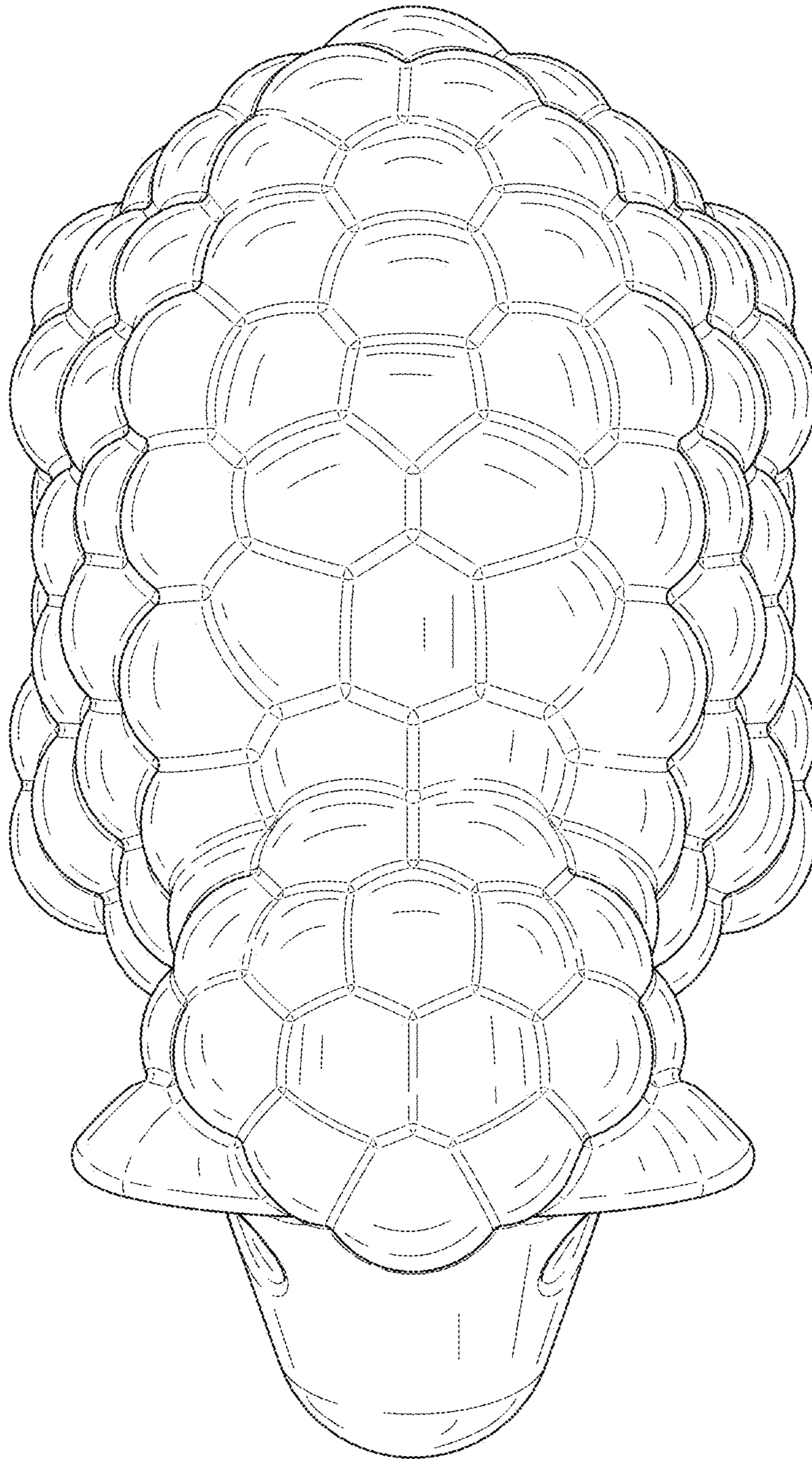

FIG. 41

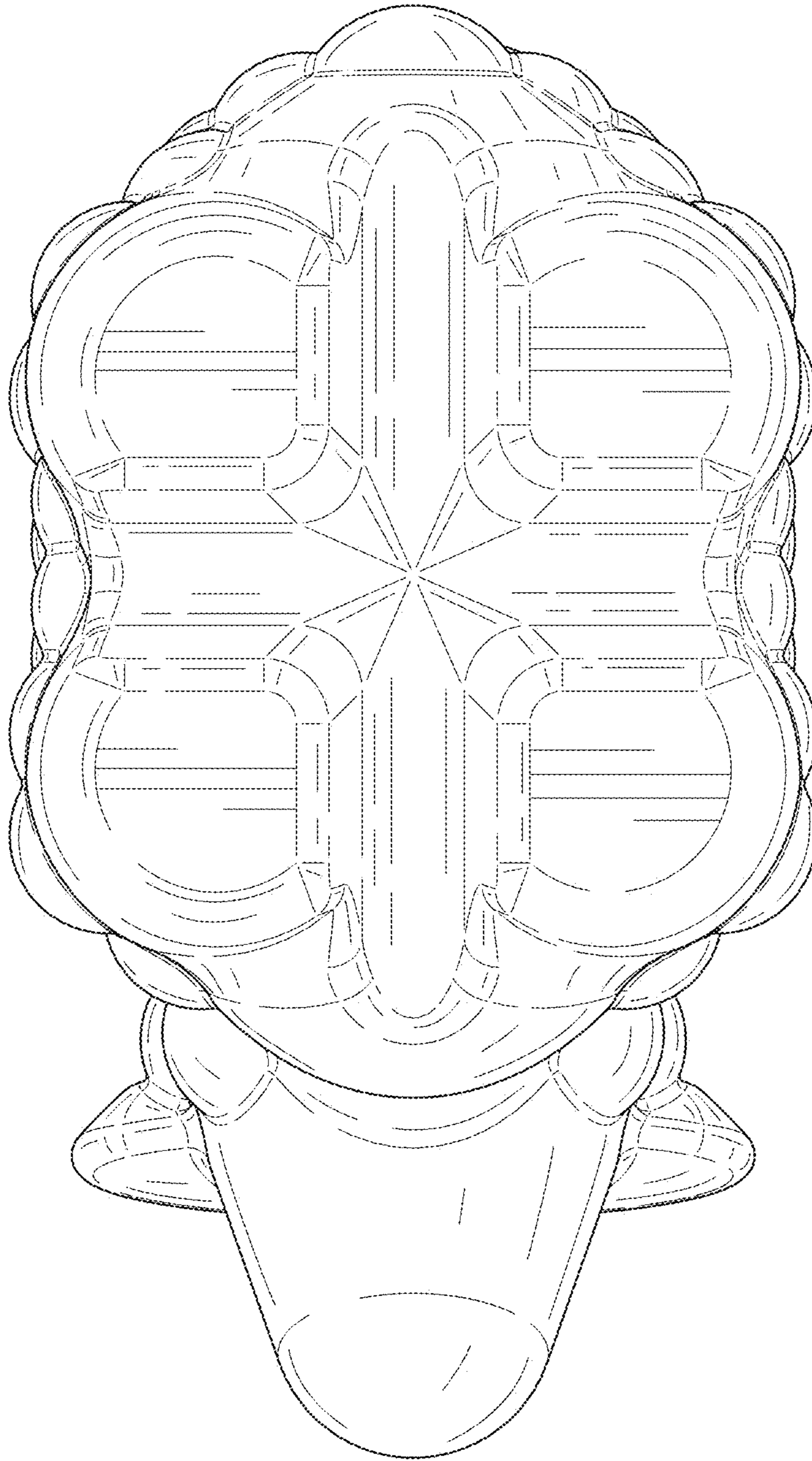

FIG. 42

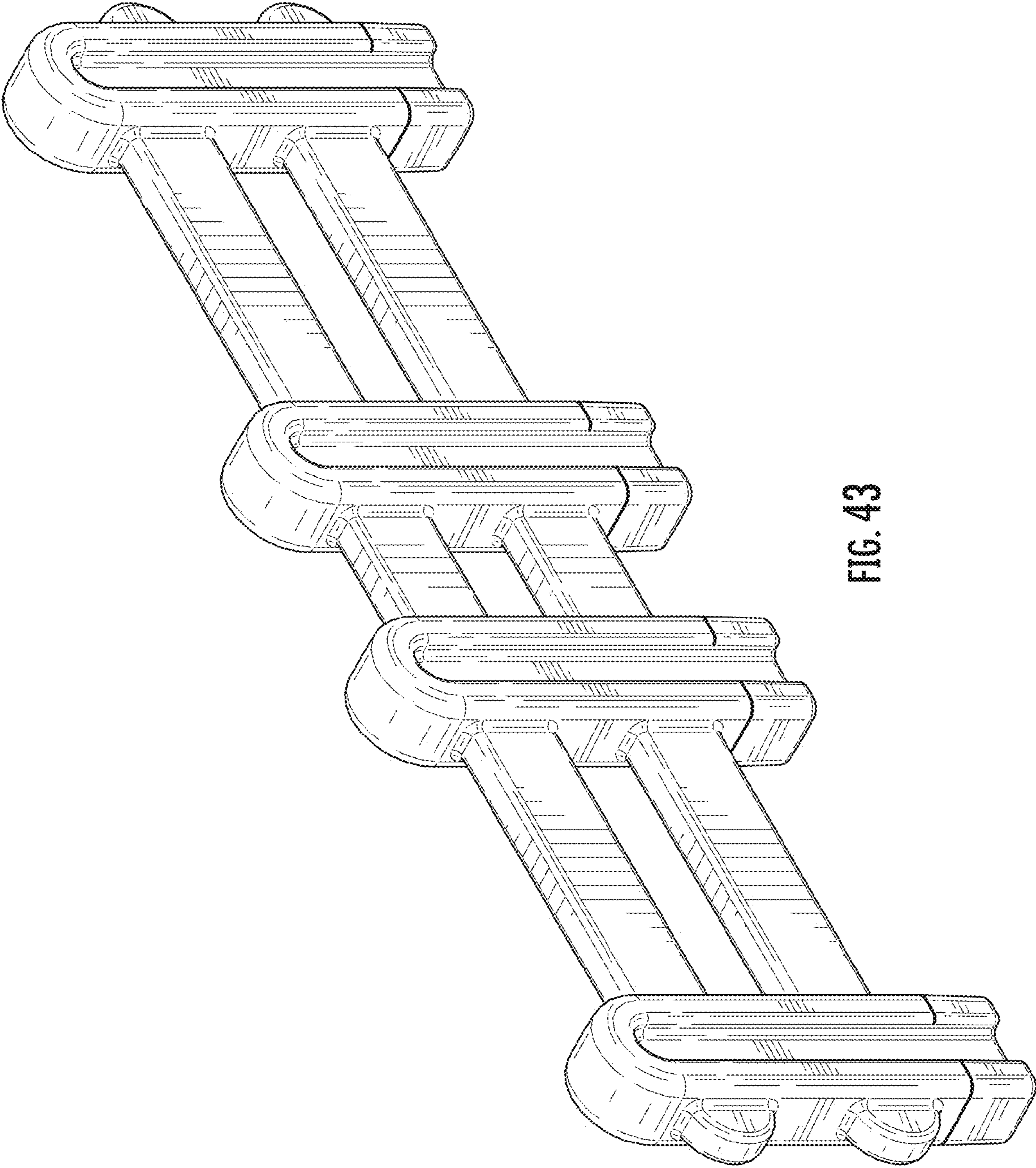

FIG. 43

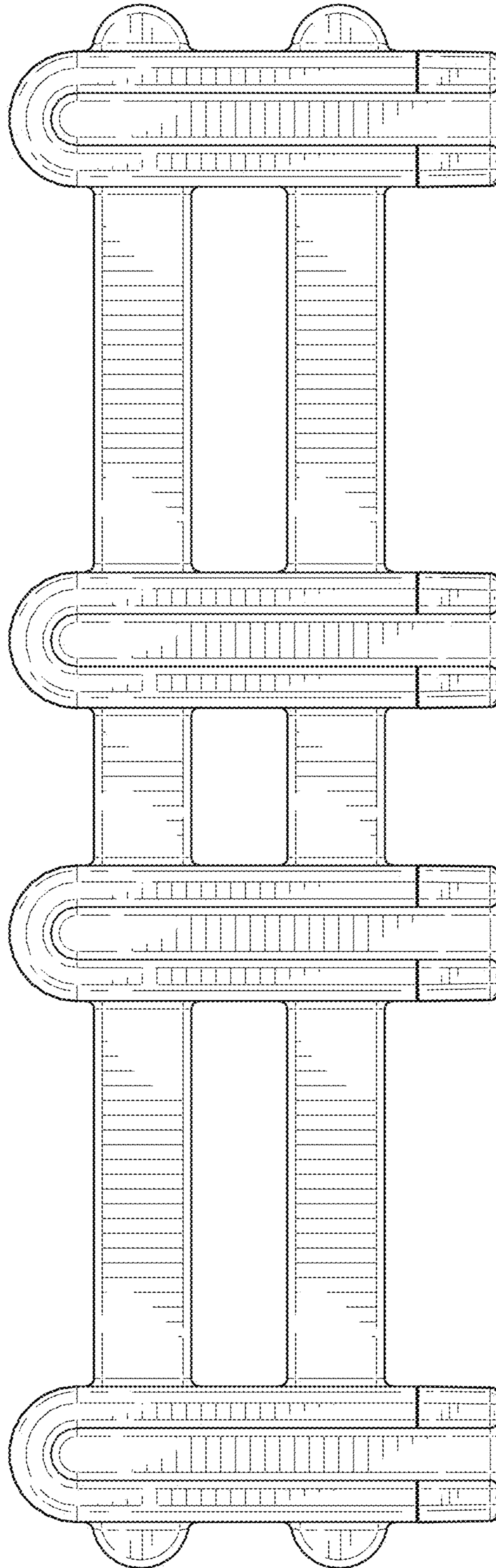

FIG. 44

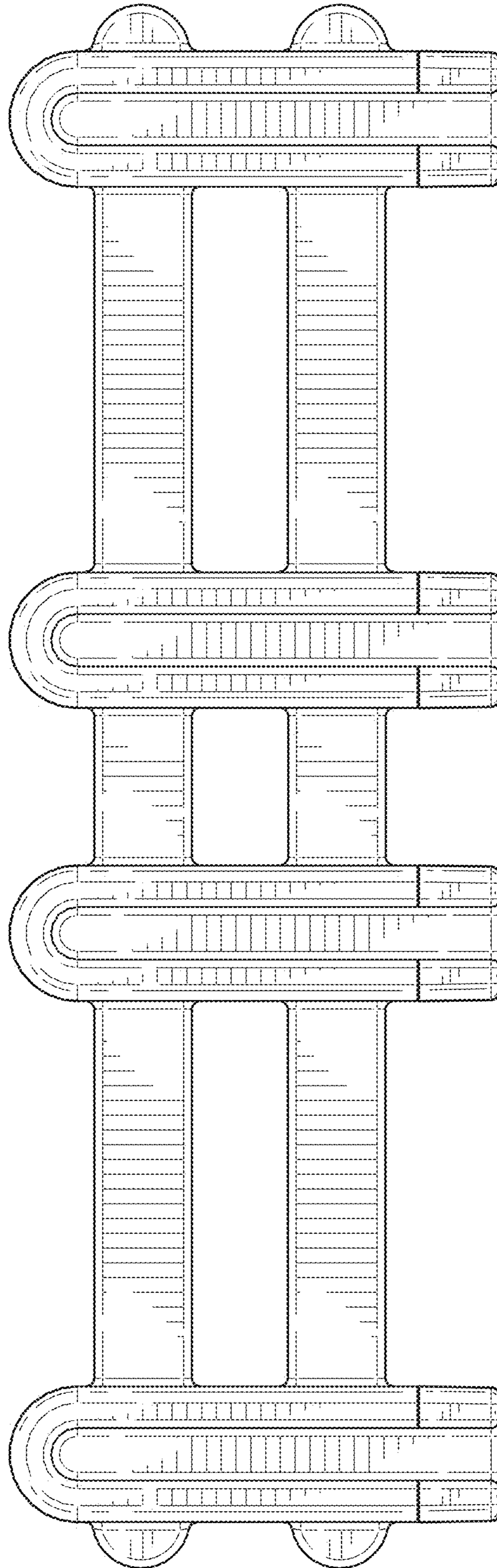

FIG. 45

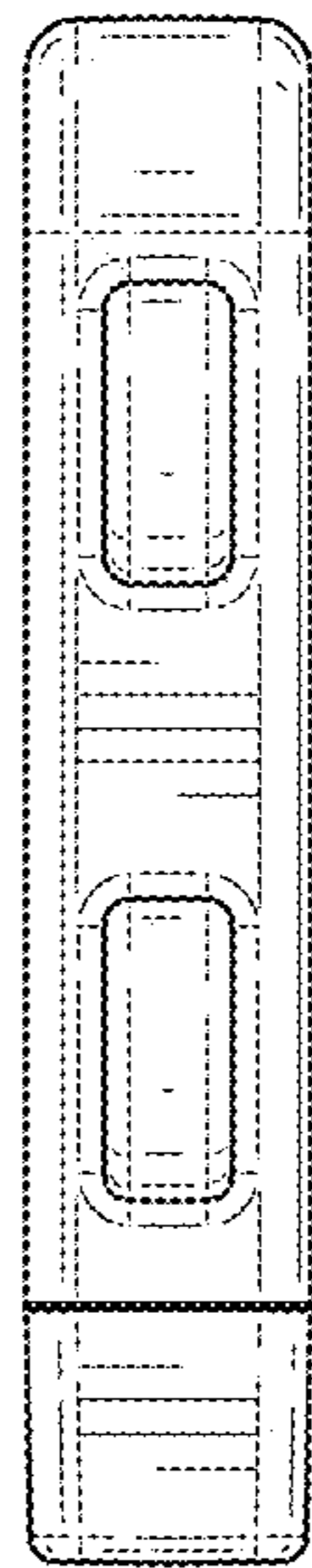

FIG. 46

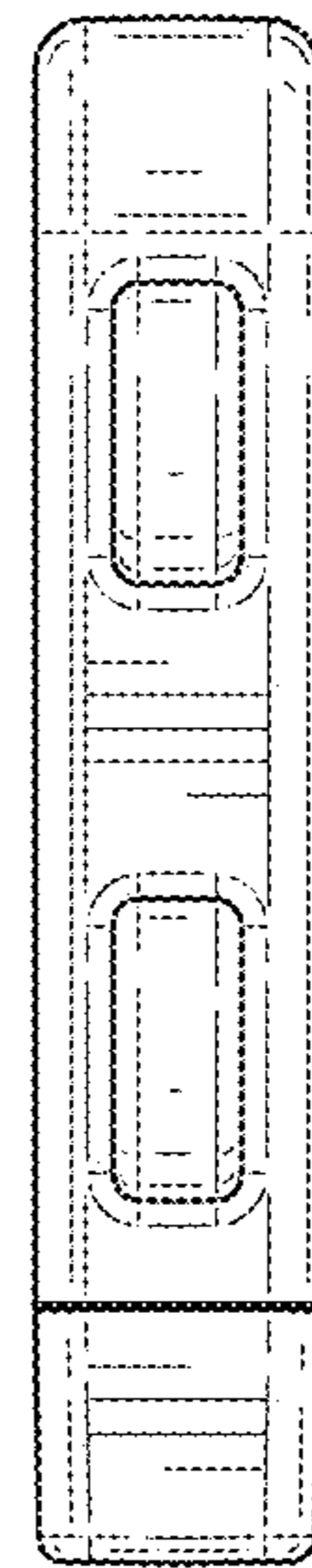

FIG. 47

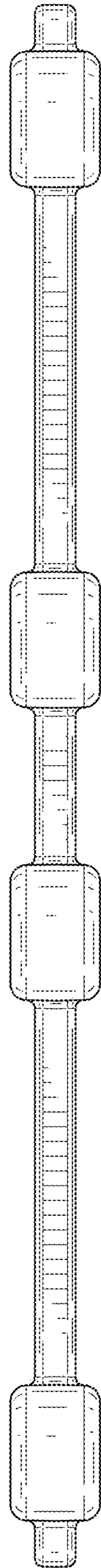

FIG. 48

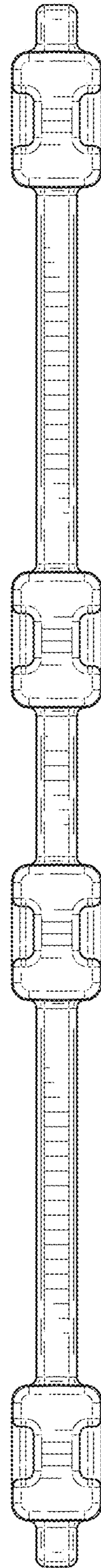

FIG. 49

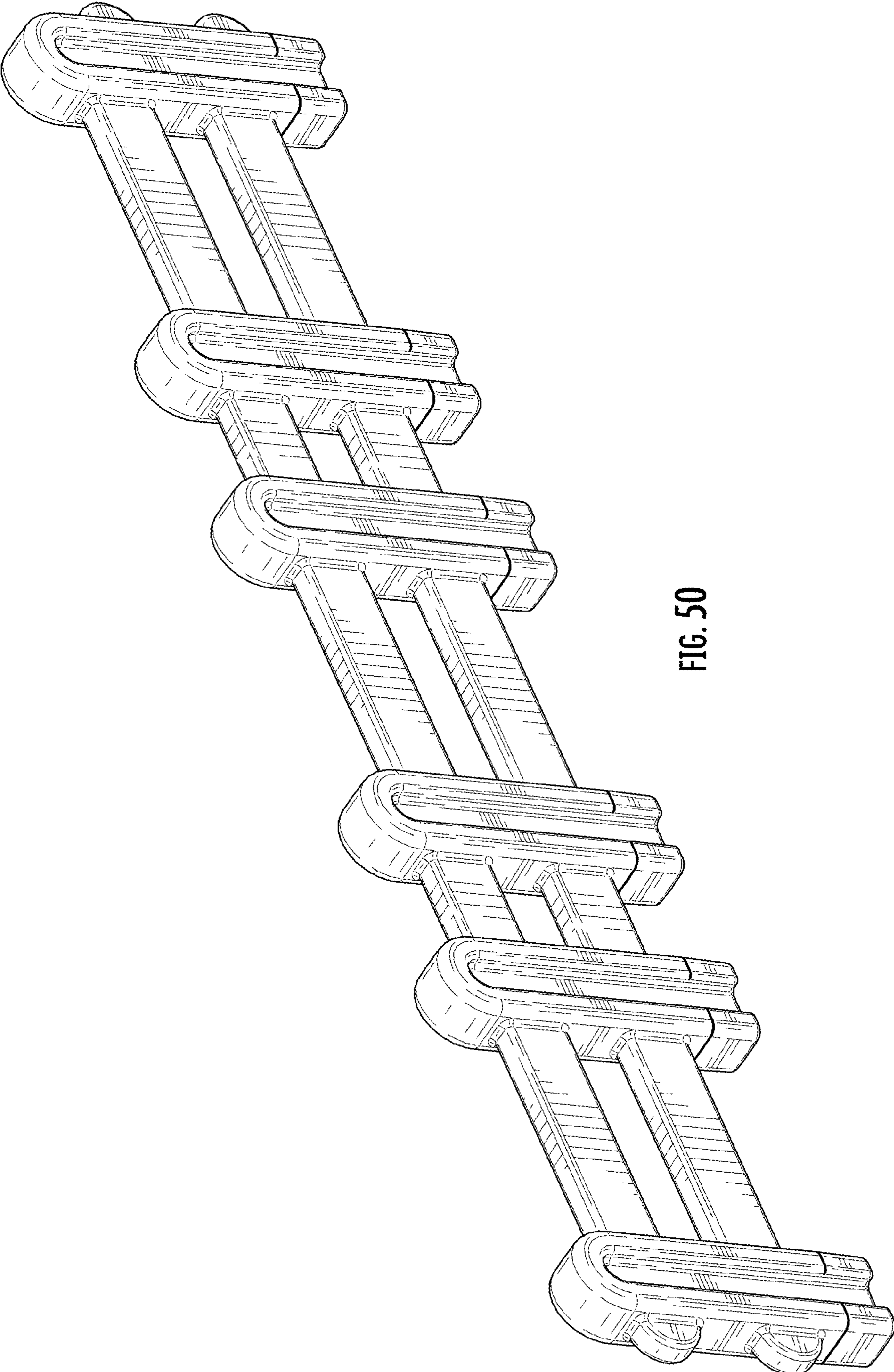

FIG. 50



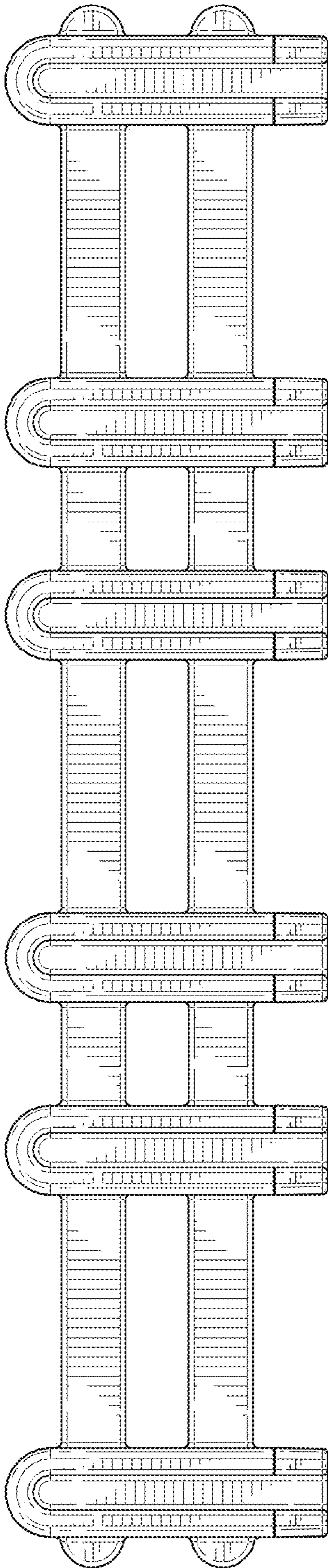

FIG. 51

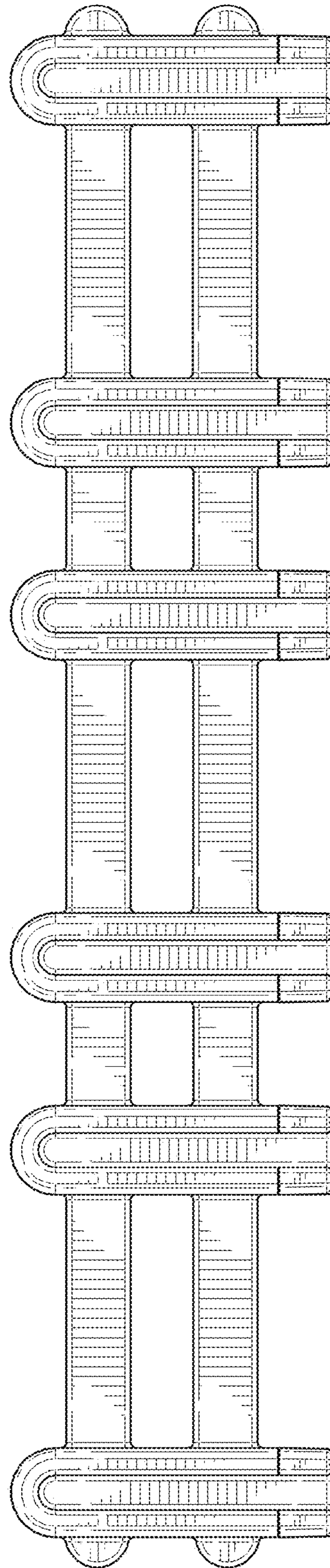

FIG. 52

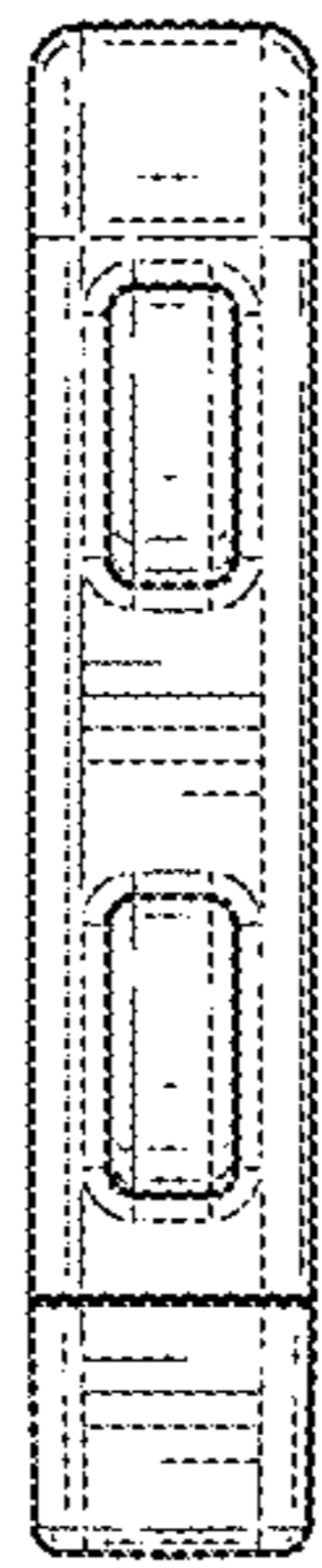

FIG. 53

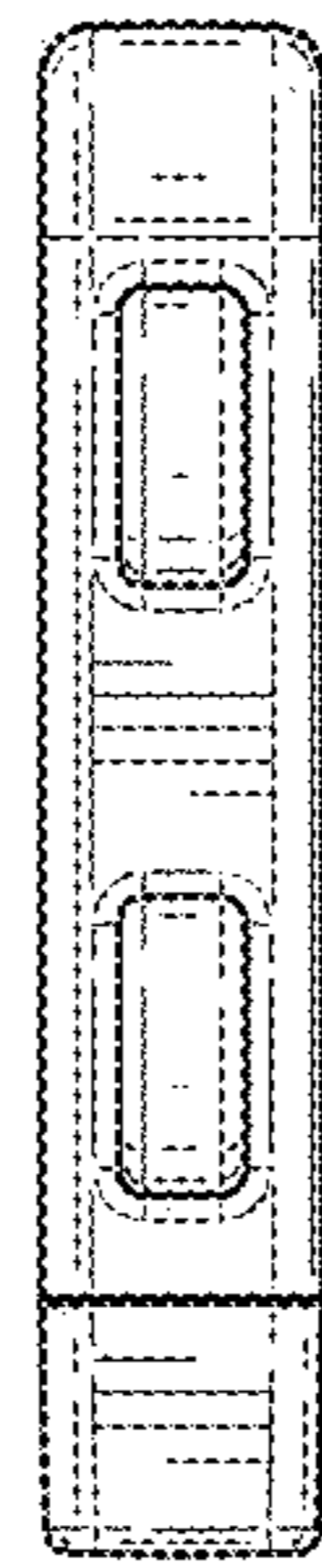

FIG. 54

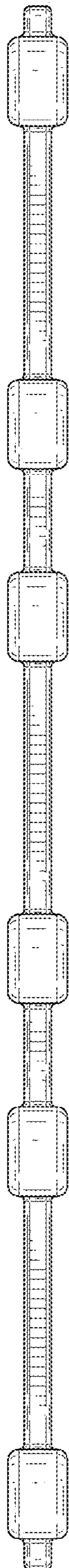

FIG. 55

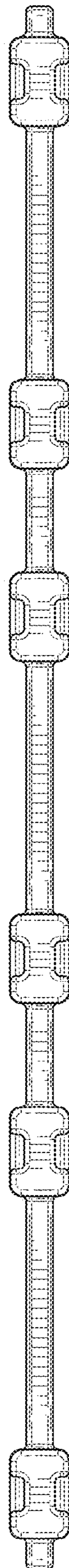

FIG. 56

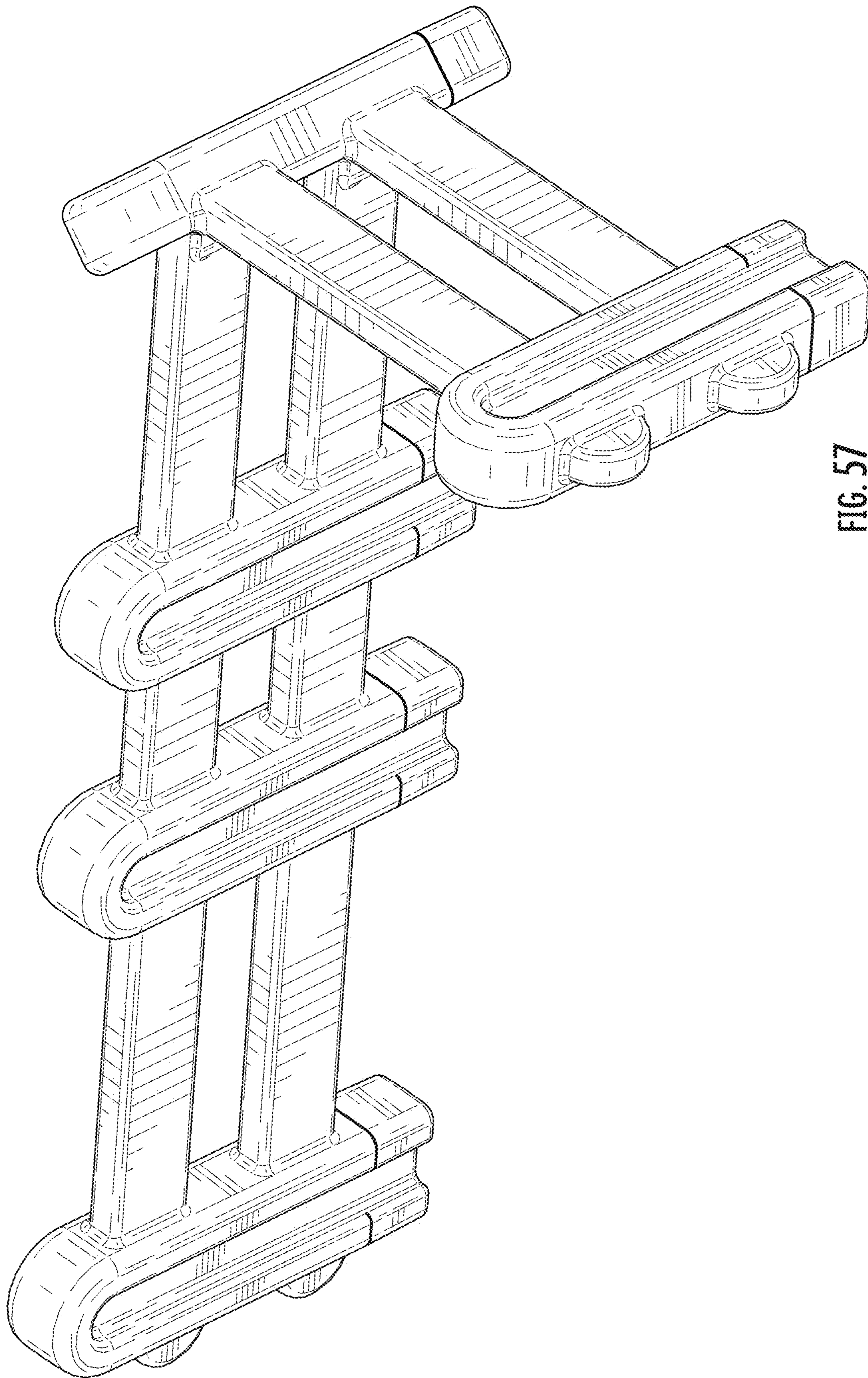

FIG. 57

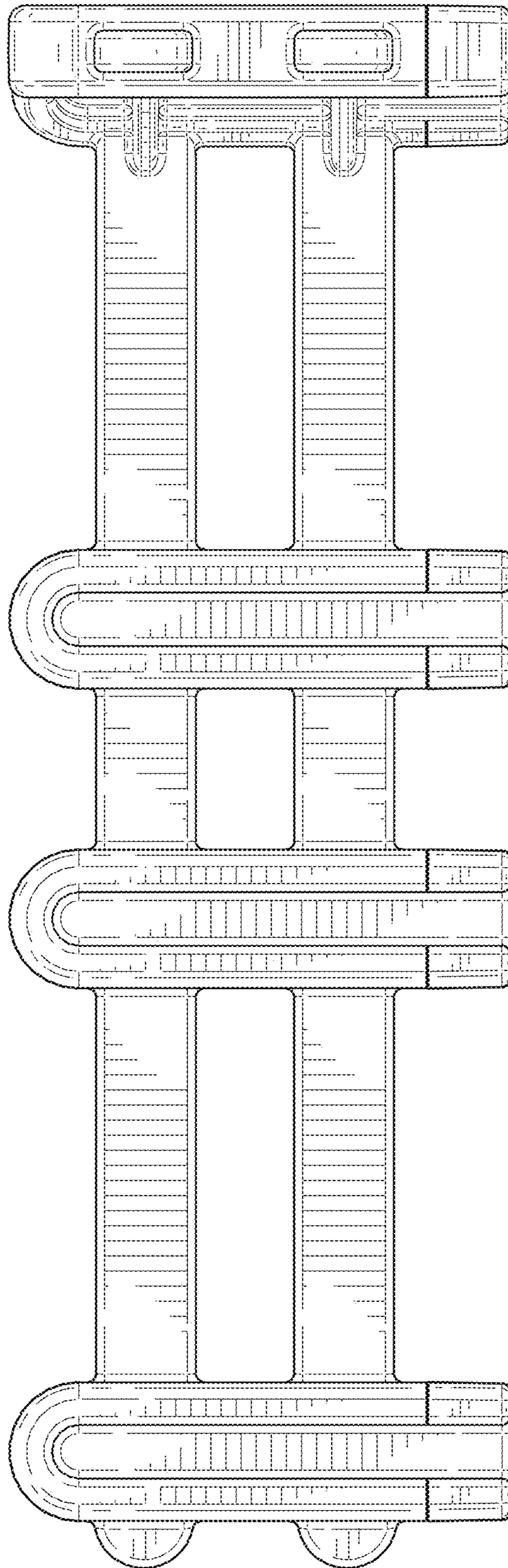

FIG. 58

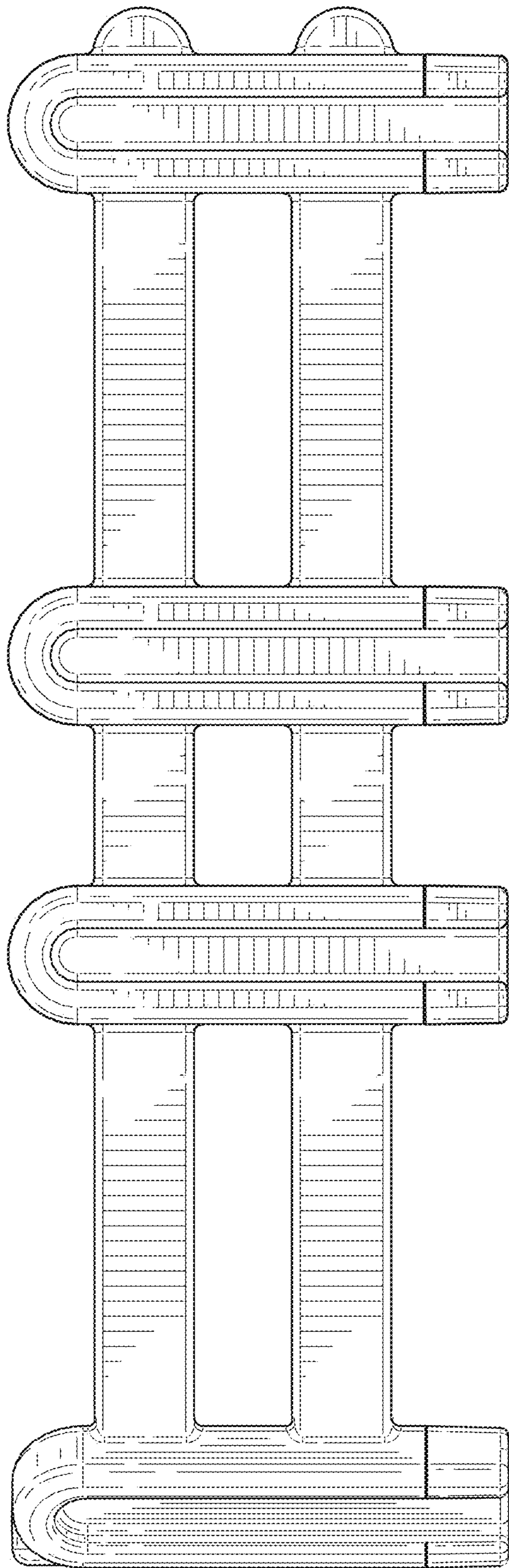

FIG. 59

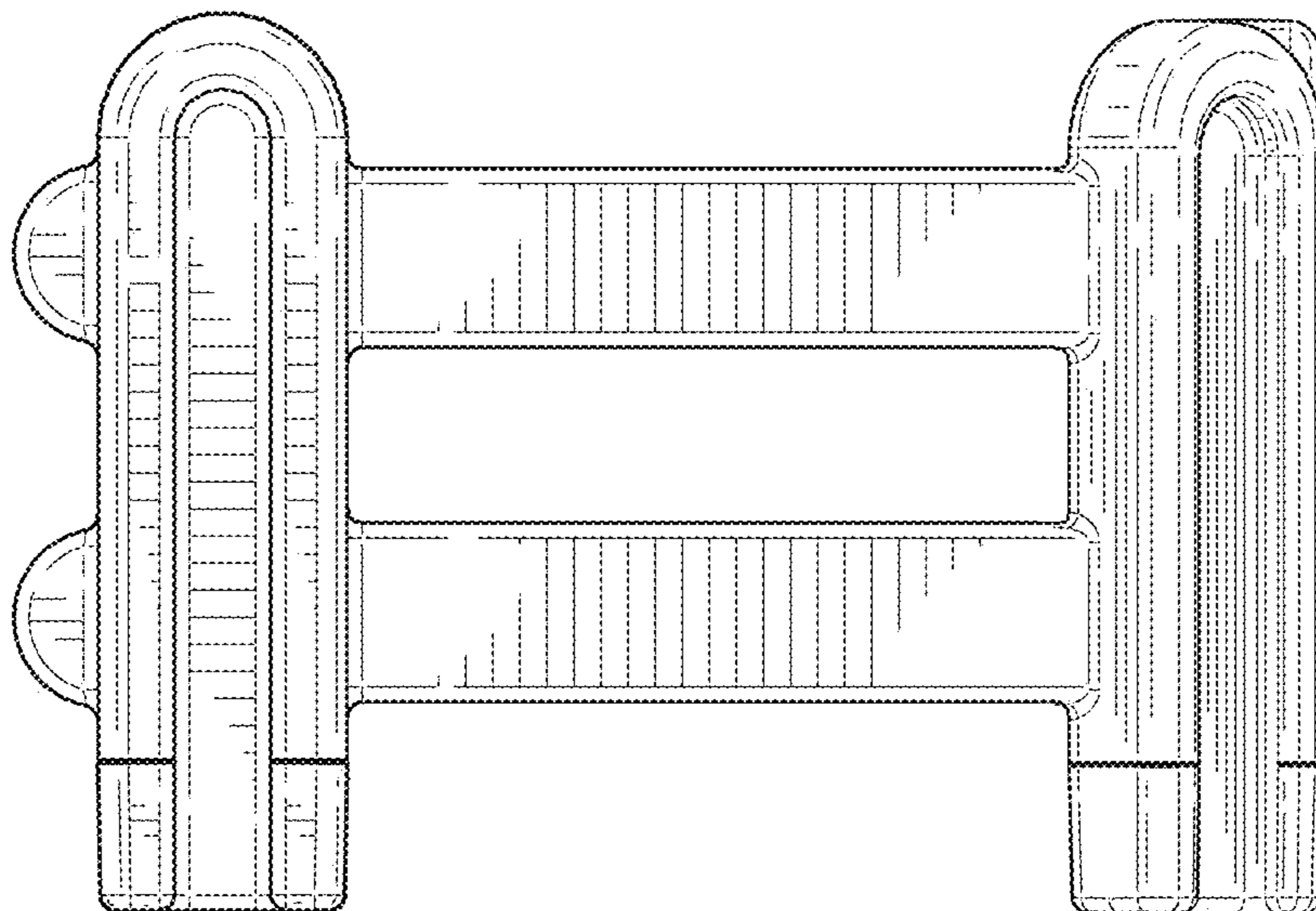

FIG. 60

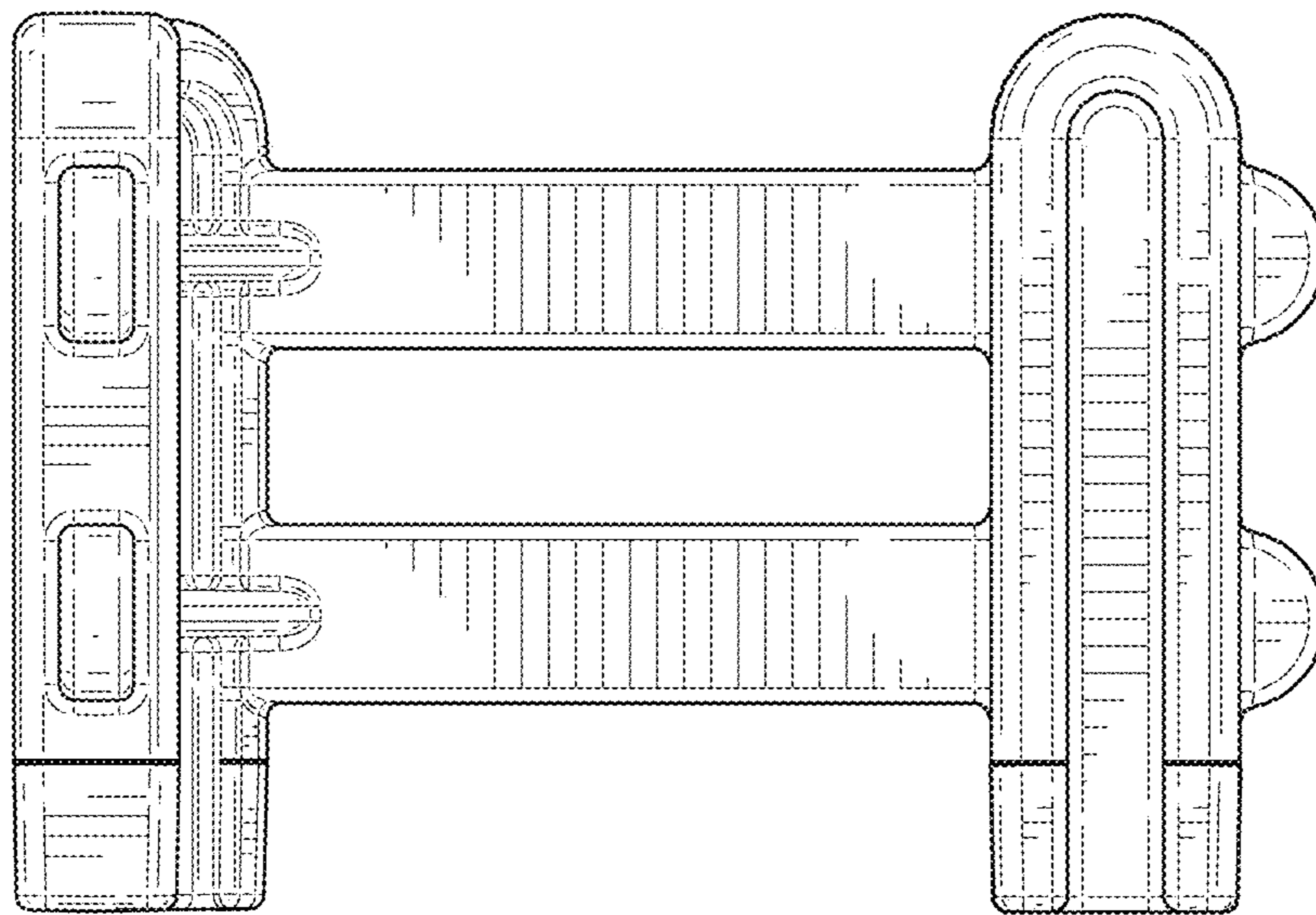

FIG. 61



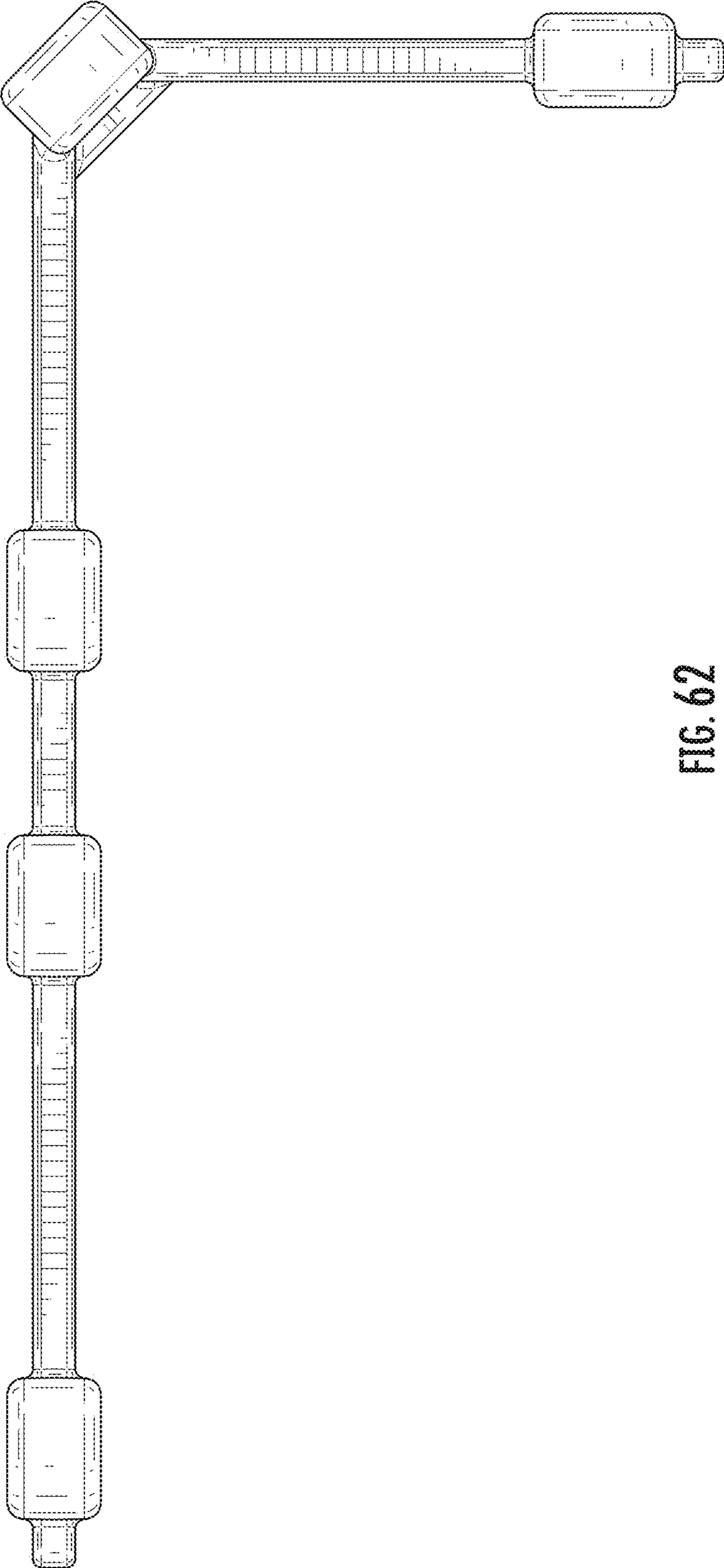

FIG. 62

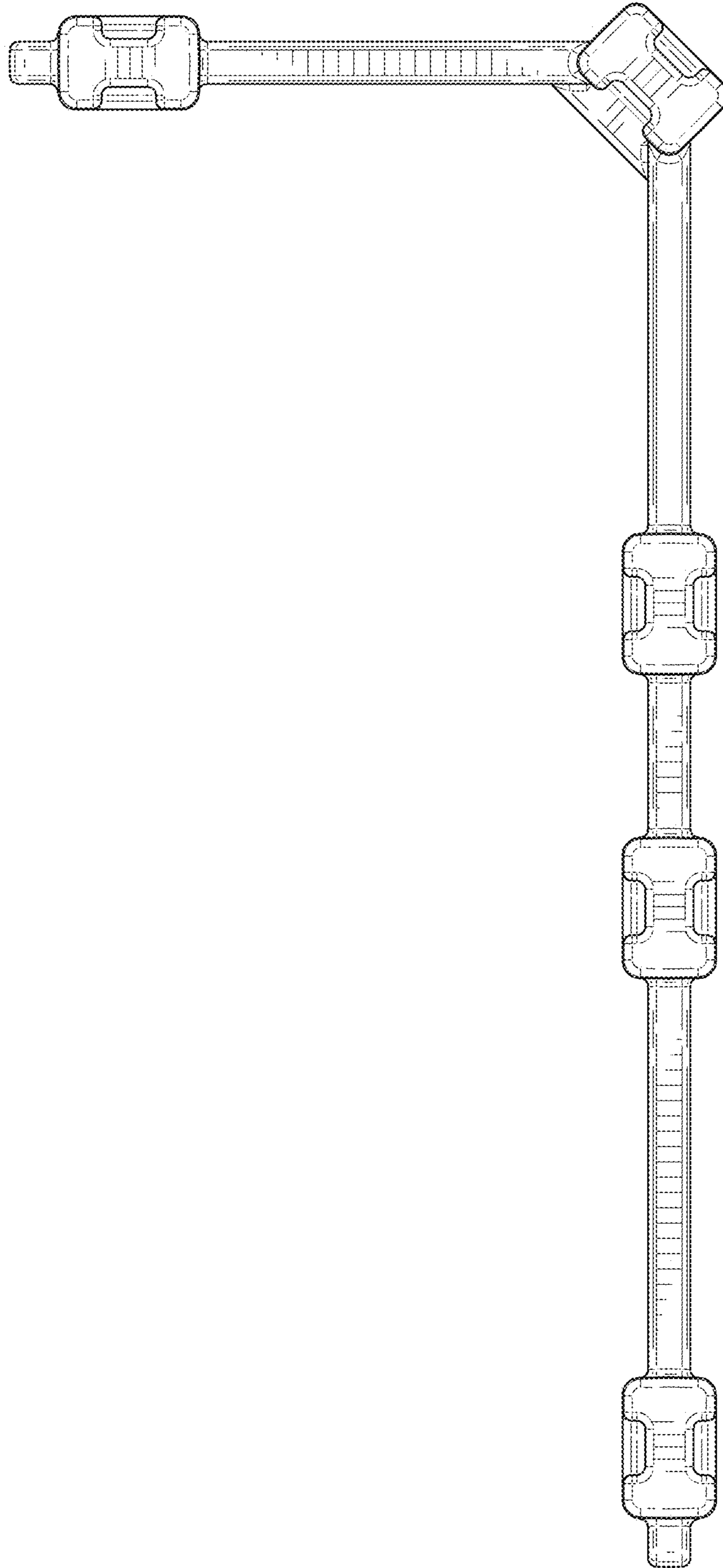

FIG. 63

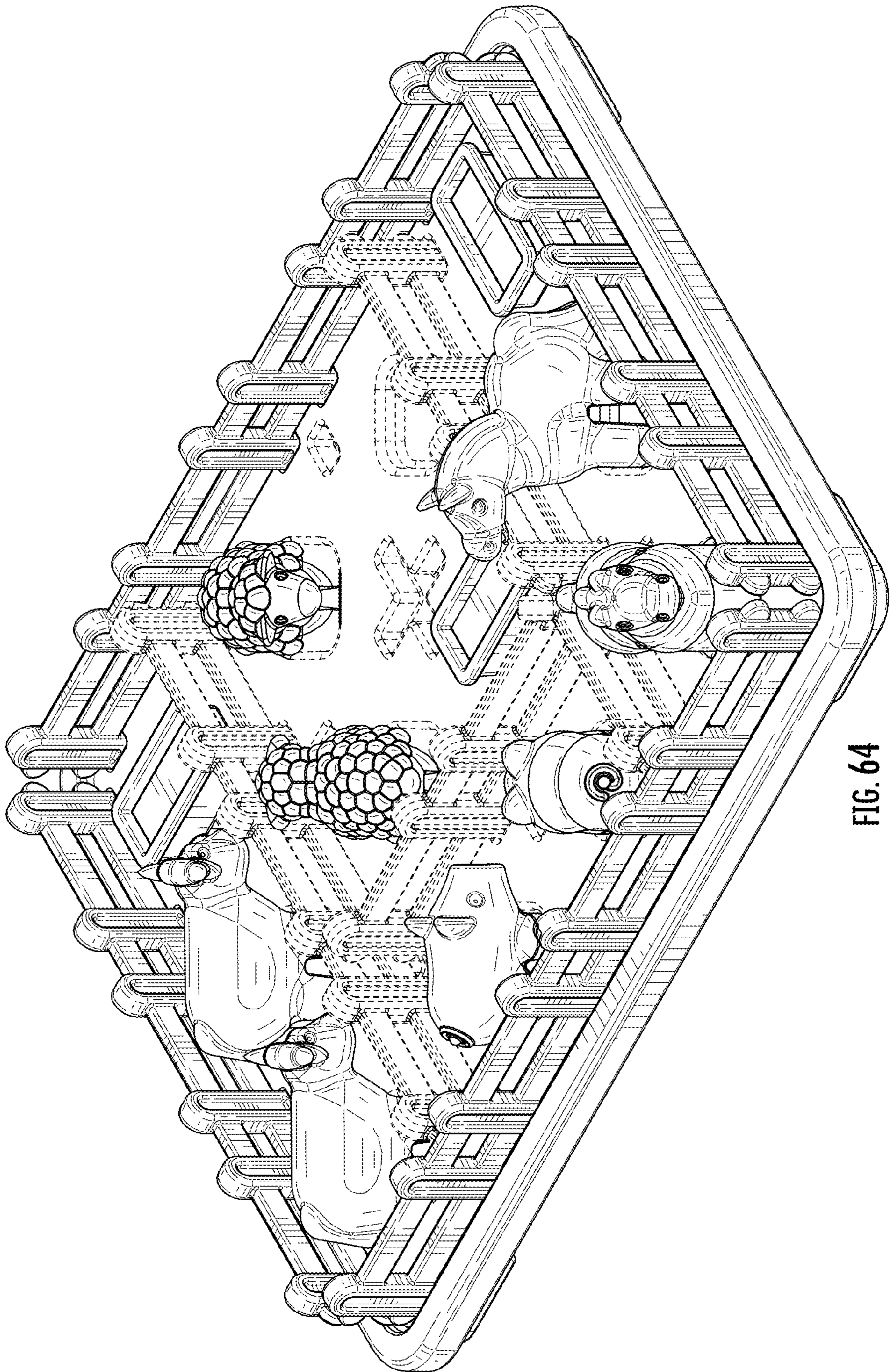

FIG. 64