



US00D914718S

(12) **United States Design Patent**
Sakuma

(10) **Patent No.:** **US D914,718 S**
(45) **Date of Patent:** **** Mar. 30, 2021**

(54) **DIGITAL CAMERA DISPLAY SCREEN WITH TRANSITIONAL GRAPHICAL USER INTERFACE**

(71) Applicant: **FUJIFILM Corporation**, Tokyo (JP)

(72) Inventor: **Nanae Sakuma**, Saitama (JP)

(73) Assignee: **FUJIFILM Corporation**, Tokyo (JP)

(**) Term: **15 Years**

(21) Appl. No.: **29/659,516**

(22) Filed: **Aug. 9, 2018**

(30) **Foreign Application Priority Data**

Feb. 14, 2018 (JP) 2018-003029
Feb. 14, 2018 (JP) 2018-003030

(51) **LOC (13) Cl.** **14-04**

(52) **U.S. Cl.**
USPC **D14/486**

(58) **Field of Classification Search**
USPC D14/485-495

(Continued)

(56) **References Cited**

U.S. PATENT DOCUMENTS

D557,699 S * 12/2007 Kim D14/485
D664,976 S * 8/2012 Everingham D14/487

(Continued)

Primary Examiner — Andrew T Nemeth

(74) *Attorney, Agent, or Firm* — Birch, Stewart, Kolash & Birch, LLP

(57) **CLAIM**

The ornamental design for a digital camera display screen with transitional graphical user interface, as shown and described.

DESCRIPTION

FIG. 1 is a perspective view of a first embodiment of the digital camera, showing the new design;

FIG. 2 is a front view thereof;
FIG. 3 is a rear view thereof;
FIG. 4 is a top view thereof;
FIG. 5 is a left view thereof;
FIG. 6 is an enlarged view of a display portion, showing a first image of the display screen of the first embodiment, shown separately for clarity;
FIG. 7 is an enlarged view of the display portion, showing a second image of the display screen of the first embodiment, shown separately for clarity;
FIG. 8 is an enlarged view of the display portion, showing a third image of the display screen of the first embodiment, shown separately for clarity;
FIG. 9 is an enlarged view of the display portion, showing a fourth image of the display screen of the first embodiment, shown separately for clarity;
FIG. 10 is an enlarged view of the display portion, showing a fifth image of the display screen of the first embodiment, shown separately for clarity;
FIG. 11 is a perspective view of a second embodiment of the digital camera, showing the new design;
FIG. 12 is a front view thereof;
FIG. 13 is a rear view thereof;
FIG. 14 is a top view thereof;
FIG. 15 is a left view thereof;
FIG. 16 is an enlarged view of the display portion, showing a first image of the display screen of the second embodiment, shown separately for clarity;
FIG. 17 is an enlarged view of the display portion, showing a second image of the display screen of the second embodiment, shown separately for clarity;
FIG. 18 is an enlarged view of the display portion, showing a third image of the display screen of the second embodiment, shown separately for clarity;
FIG. 19 is an enlarged view of the display portion, showing a fourth image of the display screen of the second embodiment shown separately for clarity; and,
FIG. 20 is an enlarged view of the display portion, showing a fifth image of the display screen of the second embodiment shown separately for clarity.

The broken lines showing the digital camera illustrate the environment of the claimed design and form no part thereof. The broken lines within the display screen in the drawings

(Continued)

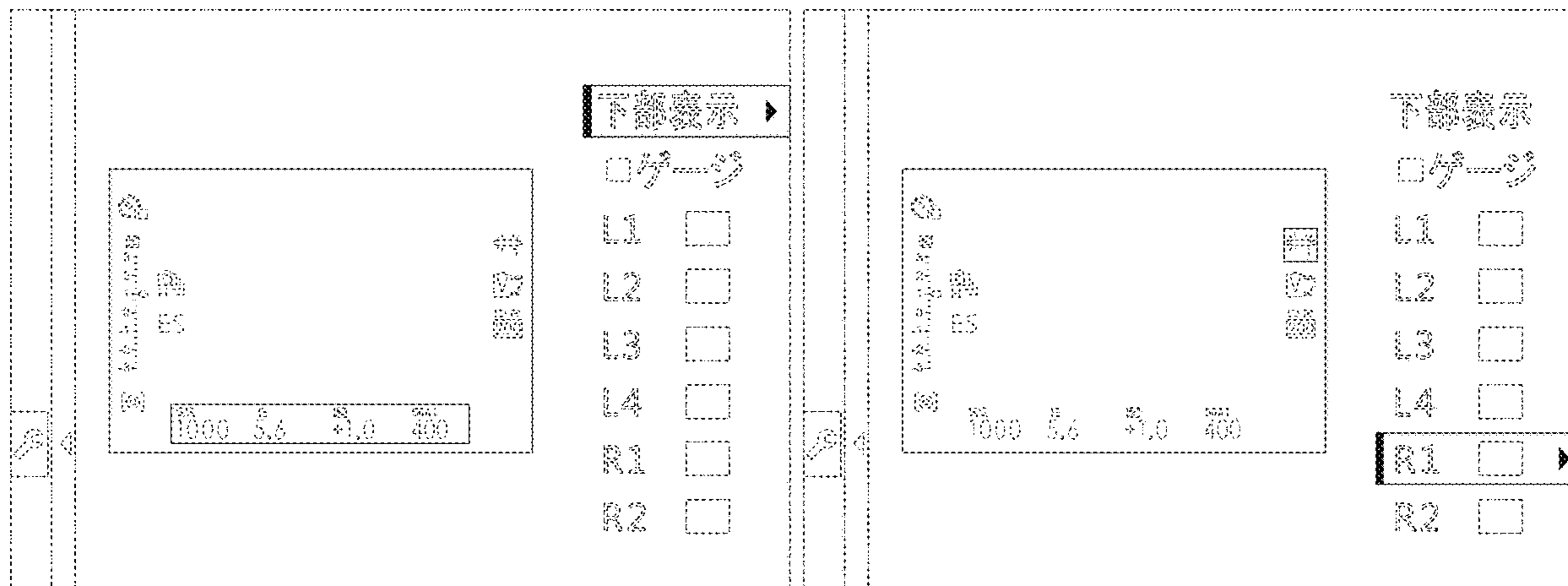

illustrate portions of the graphical user interface which form no part of the claimed design.

The appearance of the transitional graphical user interface sequentially transitions between the images shown in FIGS. 6-10 and FIGS. 16-20. The process or period in which one image transitions to another image forms no part of the claimed design.

1 Claim, 20 Drawing Sheets

(58) Field of Classification Search

CPC G06F 3/048-04897

See application file for complete search history.

(56) References Cited

U.S. PATENT DOCUMENTS

D689,885 S * 9/2013 Edwards D14/485
 D691,170 S * 10/2013 Thomsen D14/487

D702,256 S * 4/2014 Danhope D14/488
 D726,197 S * 4/2015 Kim D14/485
 D738,396 S * 9/2015 Kenmochi D14/488
 D794,050 S * 8/2017 Omata D14/486
 D797,804 S * 9/2017 Sakuma D14/492
 D799,501 S * 10/2017 Azam D14/485
 D803,862 S * 11/2017 Omata D14/487
 D806,090 S * 12/2017 Azam D14/485
 D808,978 S * 1/2018 Hazam D14/485
 D808,979 S * 1/2018 Hazam D14/485
 D808,980 S * 1/2018 Hazam D14/485
 D808,981 S * 1/2018 Hazam D14/485
 D821,433 S * 6/2018 Omata D14/486
 D822,051 S * 7/2018 Omata D14/486
 D835,117 S * 12/2018 Roberts D14/485
 D853,423 S * 7/2019 Zimmerman D14/486
 D867,391 S * 11/2019 Yoshioka D14/488
 D872,105 S * 1/2020 Omata D14/485
 D894,914 S * 9/2020 Bickel D14/485
 D894,934 S * 9/2020 Wang D14/486

* cited by examiner

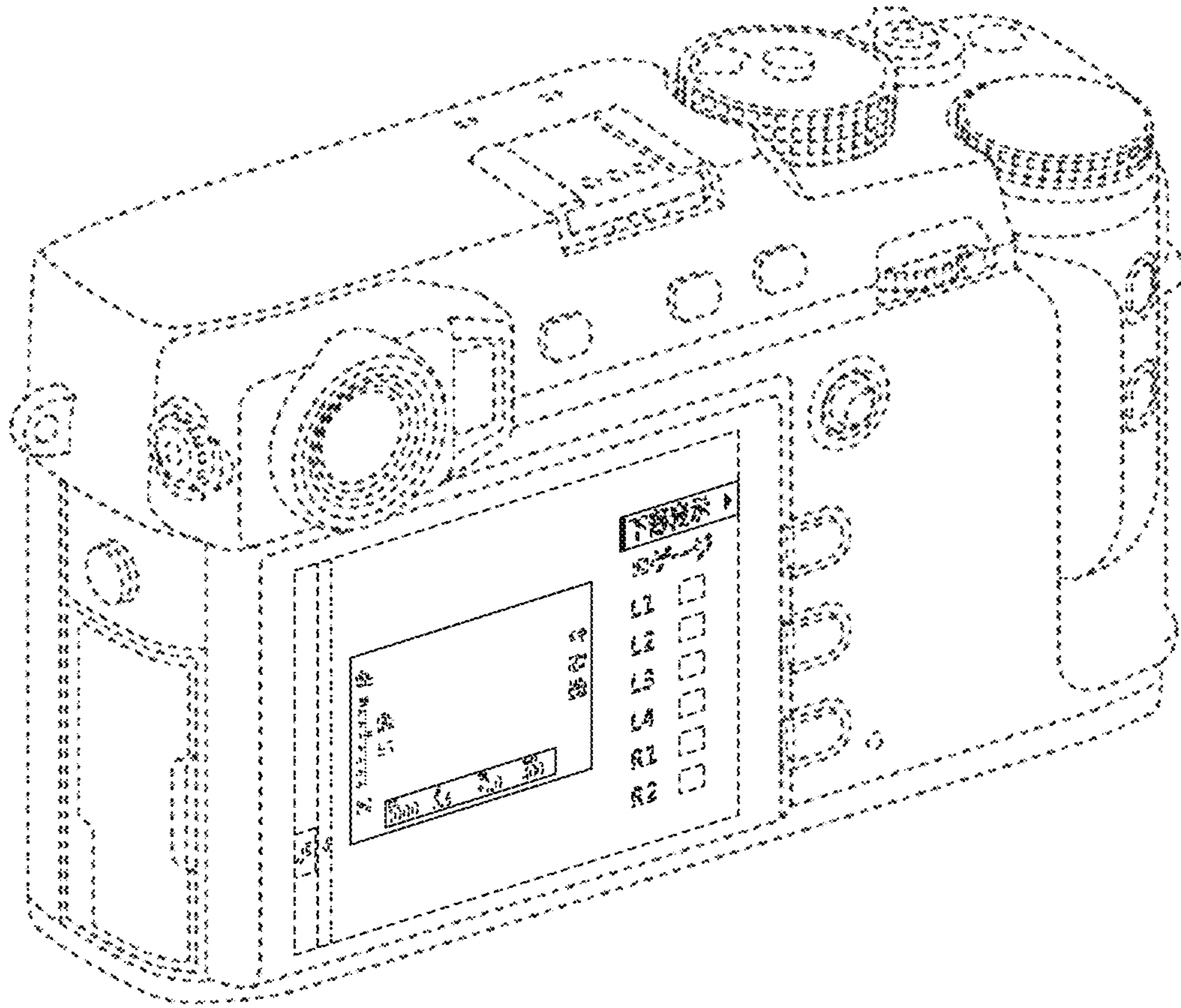

FIG.1

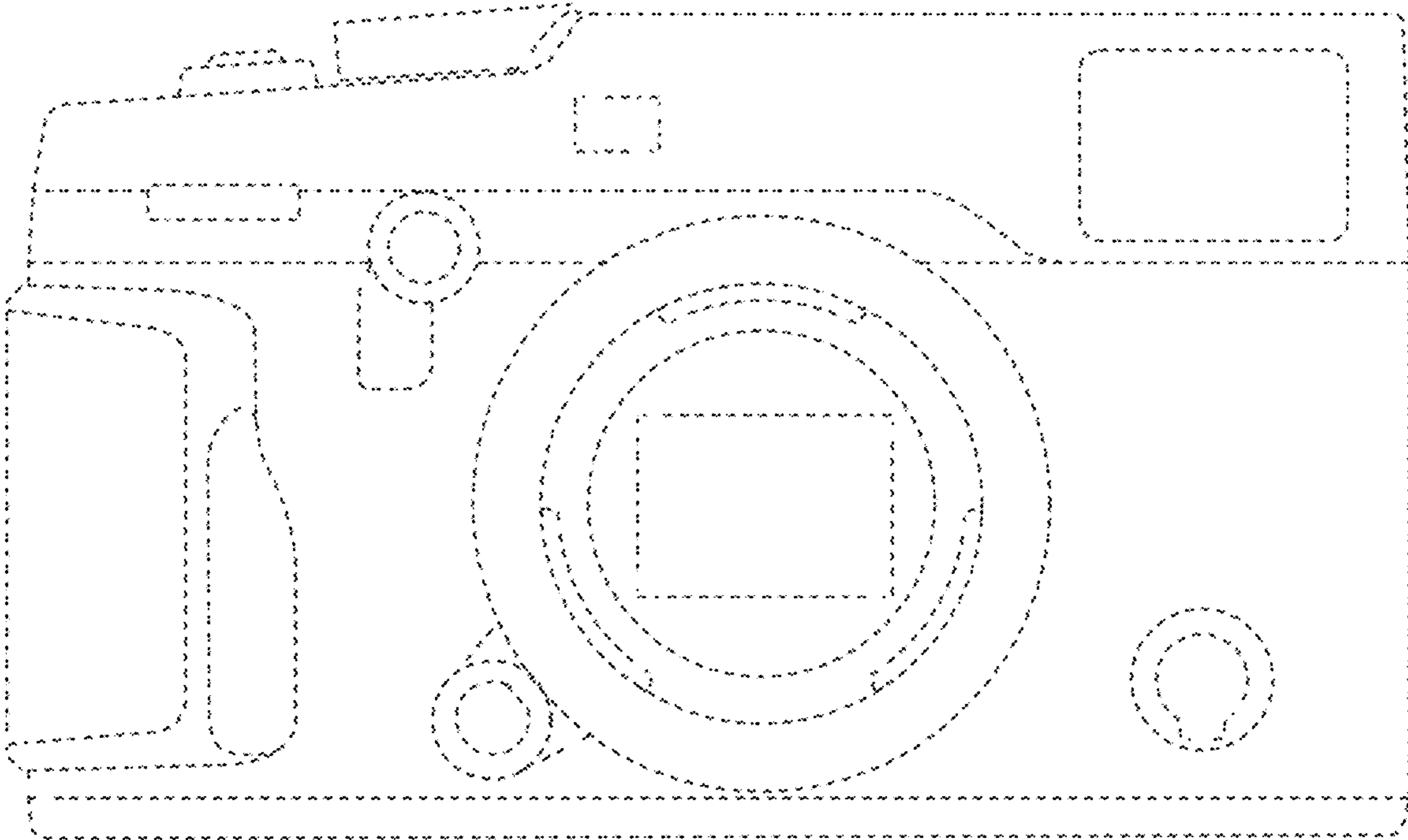

FIG.2

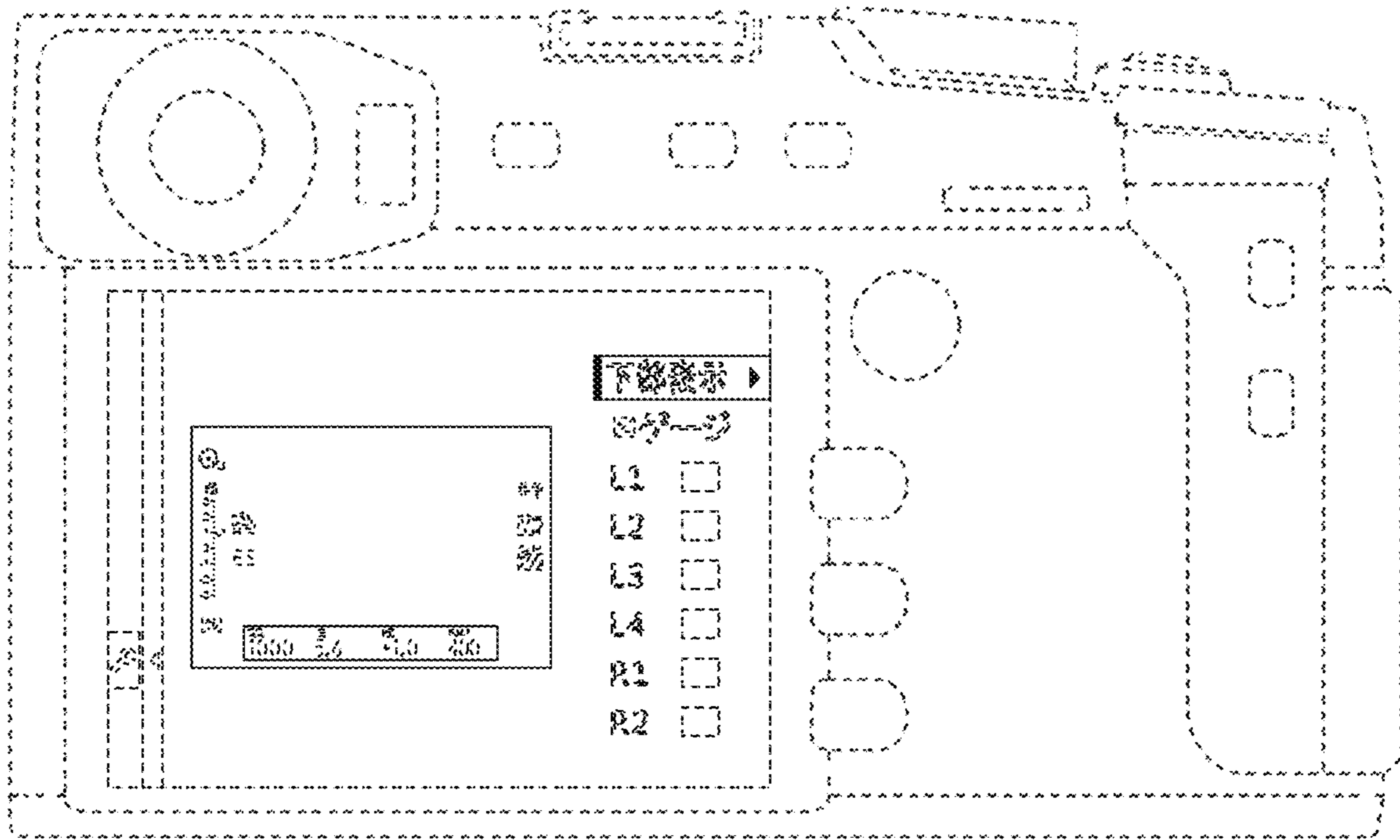

FIG.3

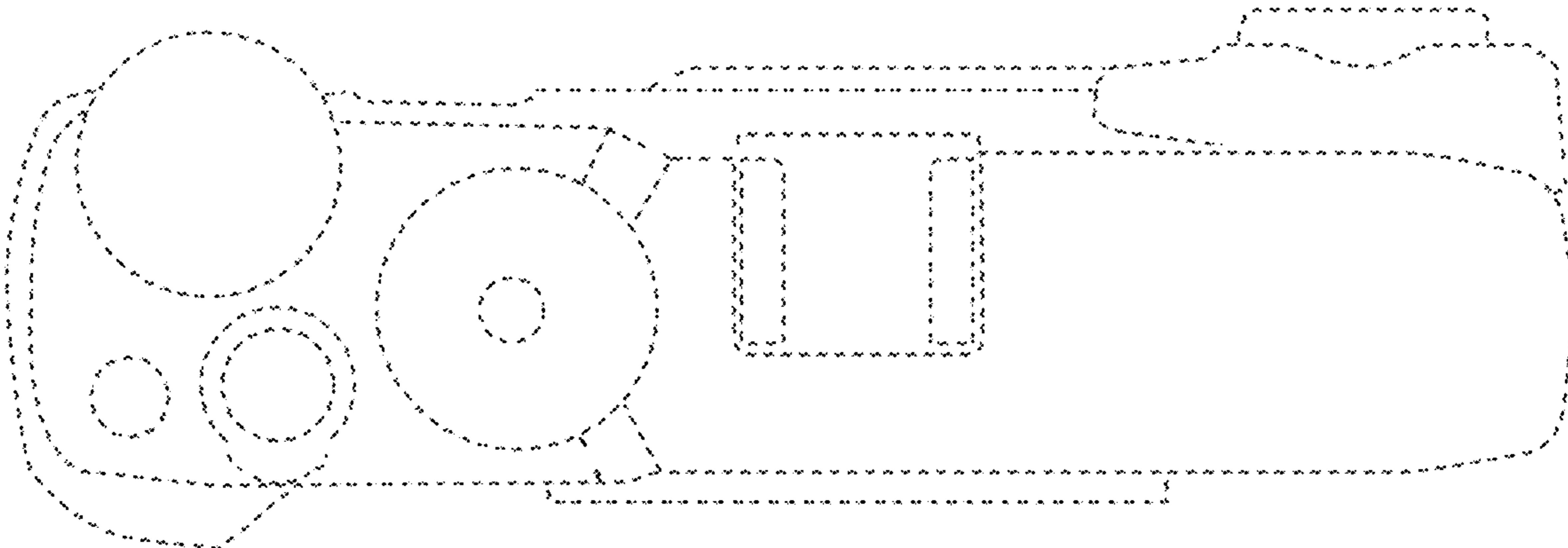

FIG.4

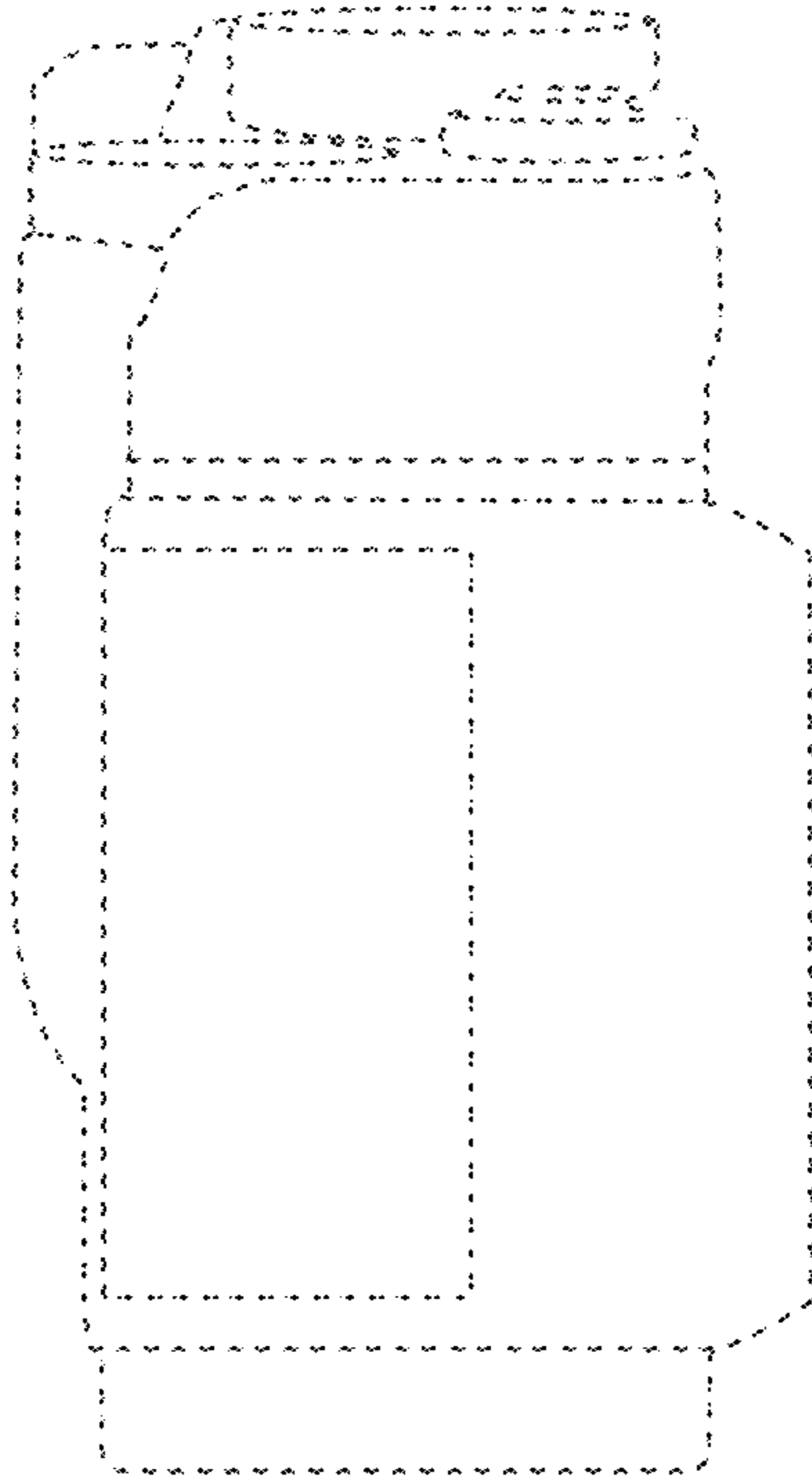

FIG.5

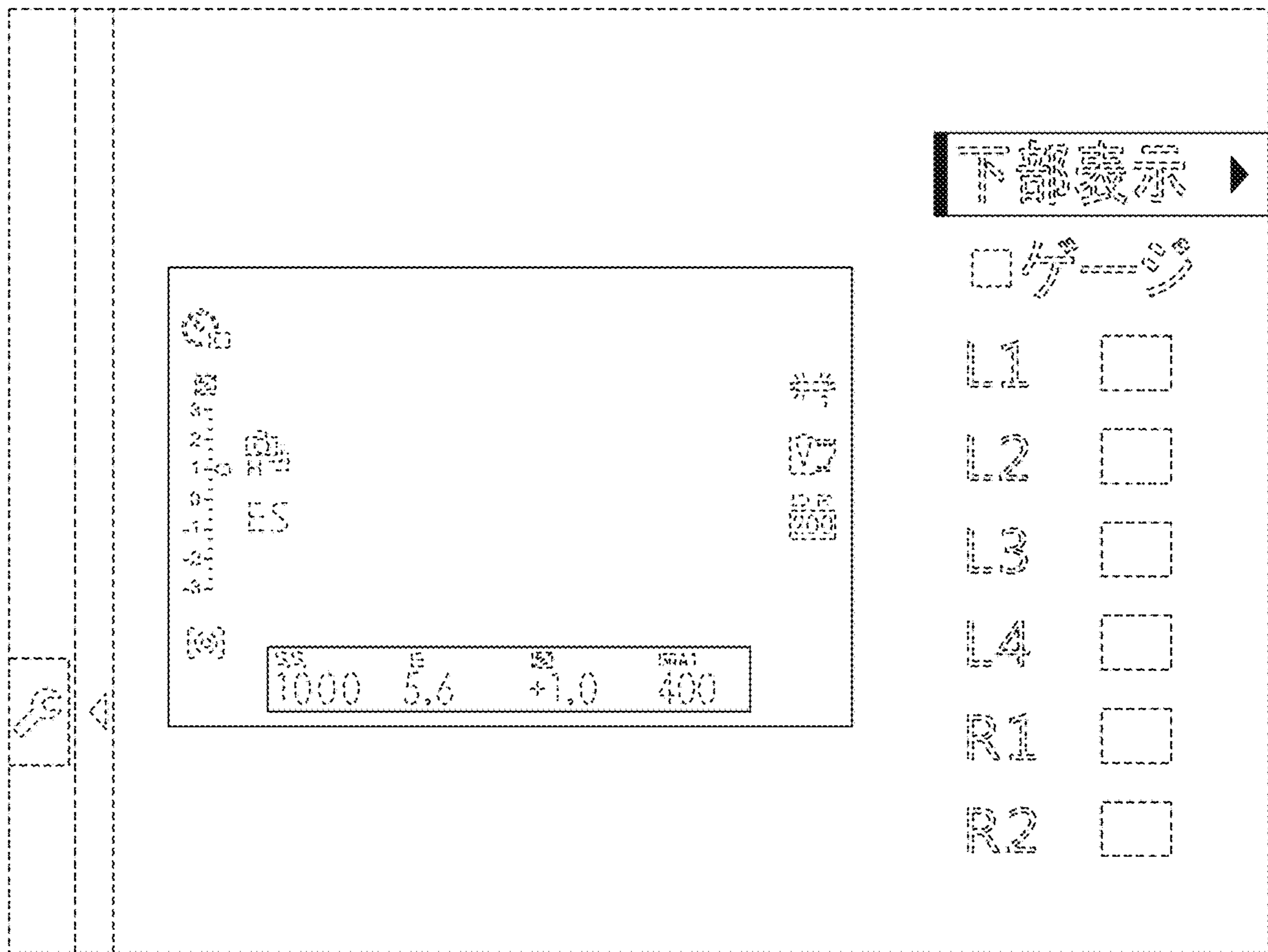

FIG.6

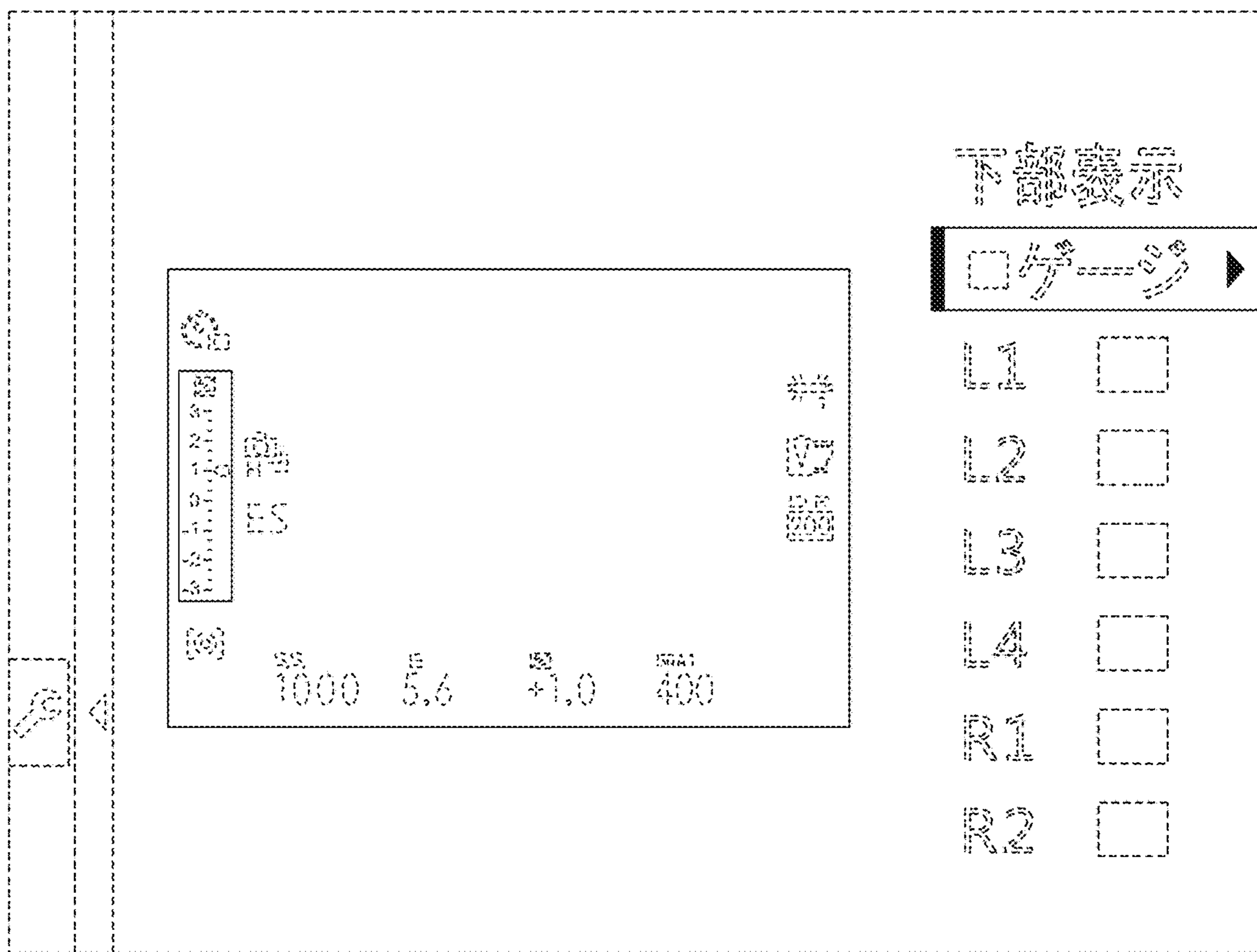

FIG.7

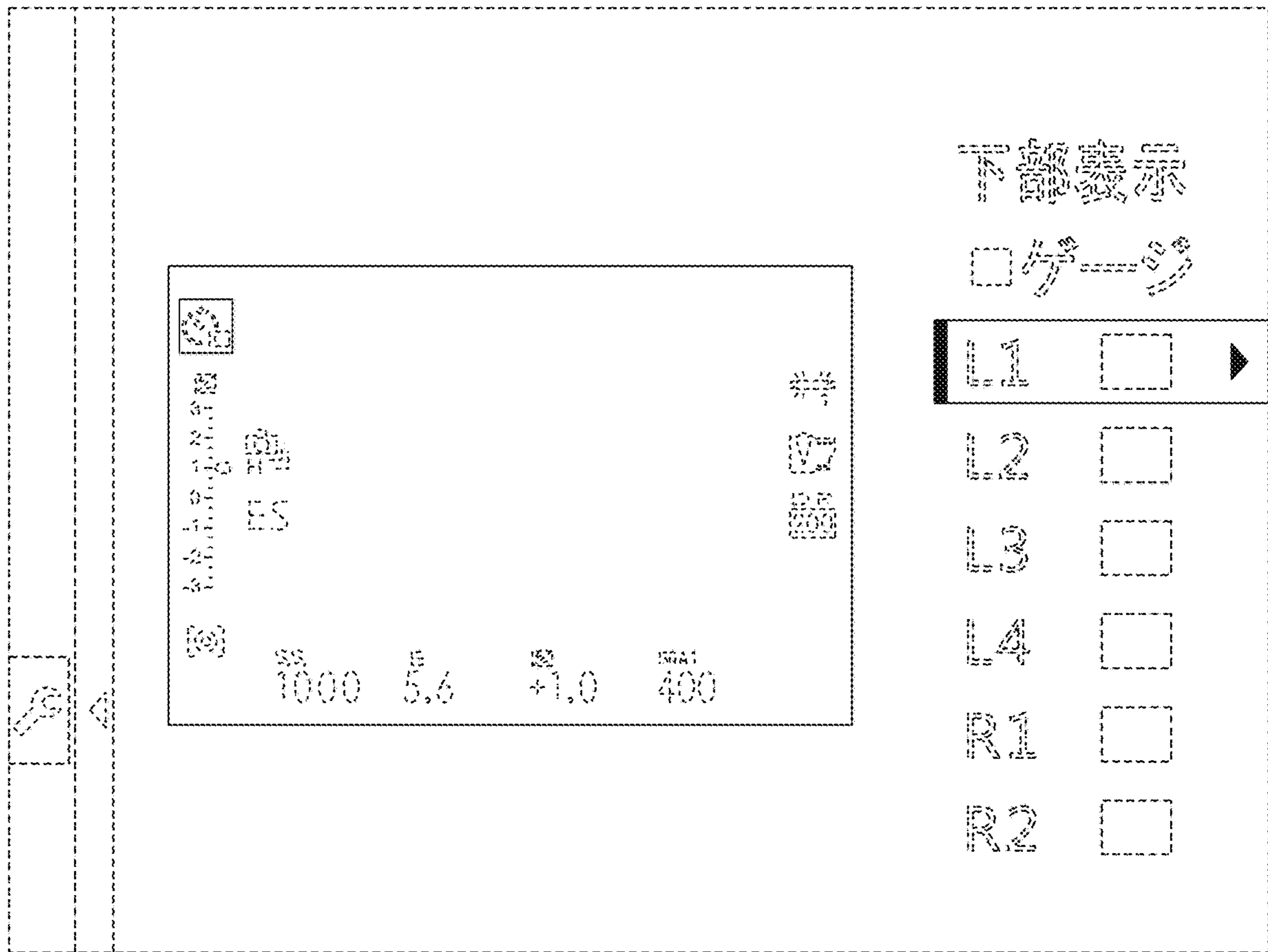

FIG.8

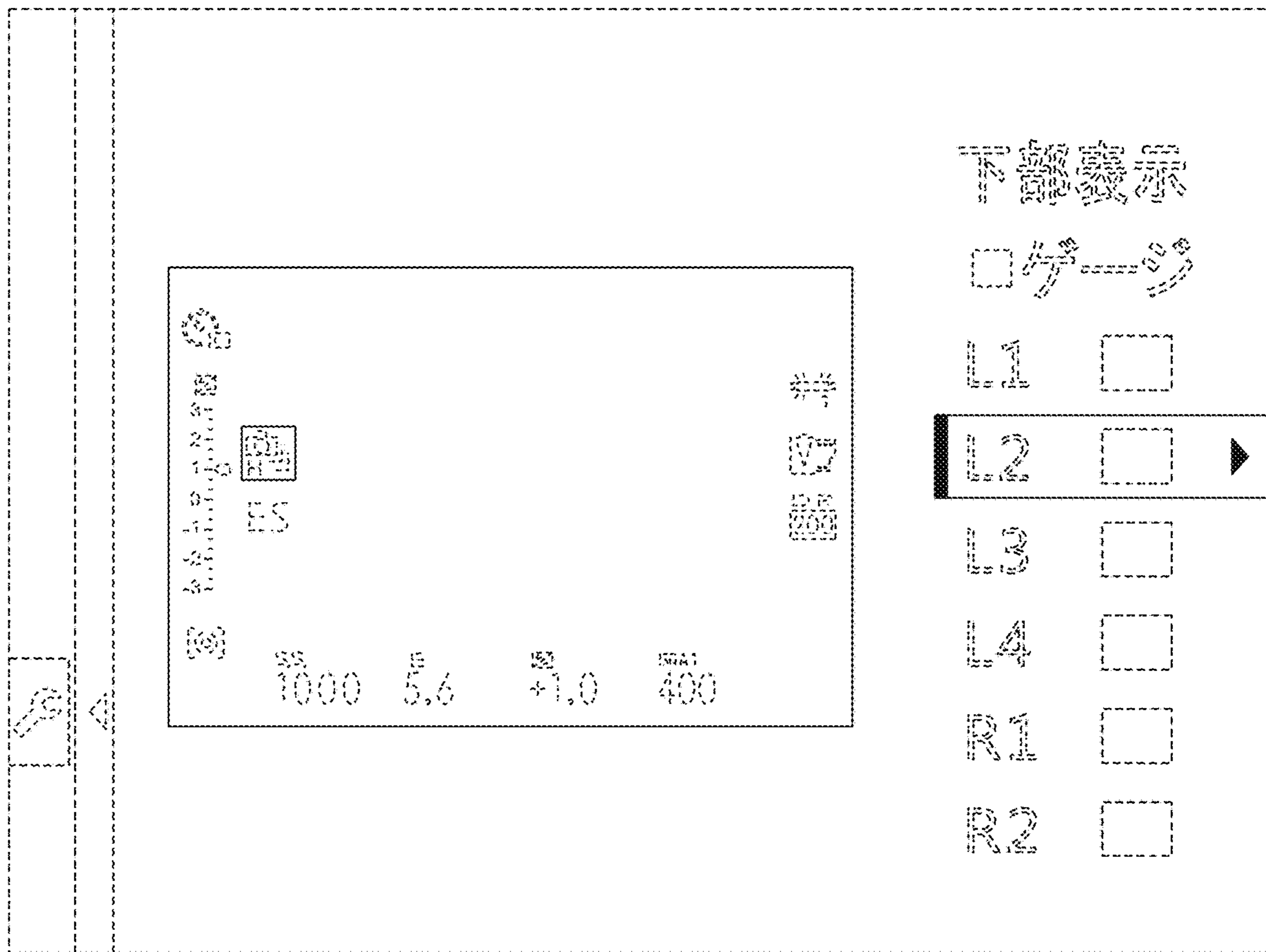

FIG.9

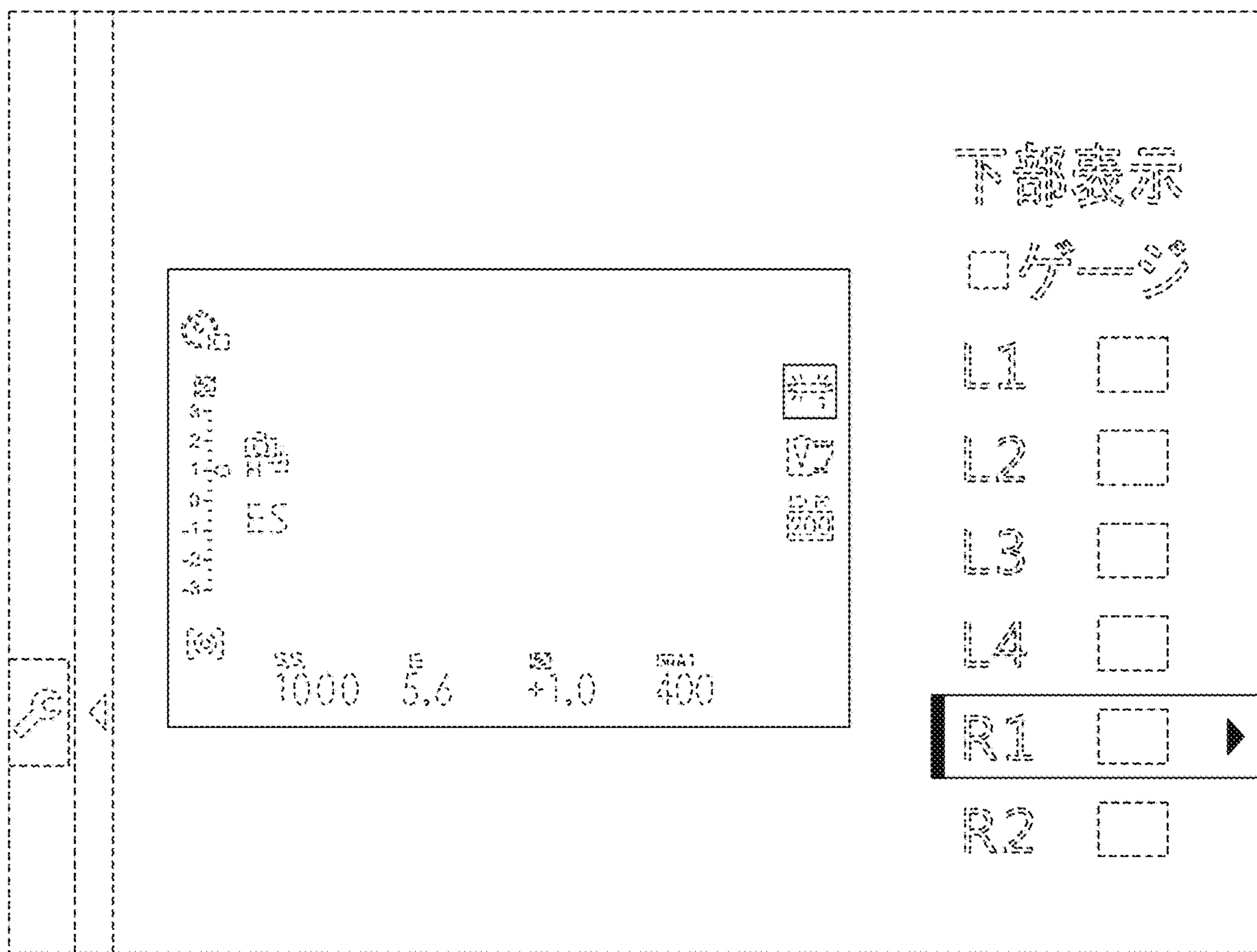

FIG.10

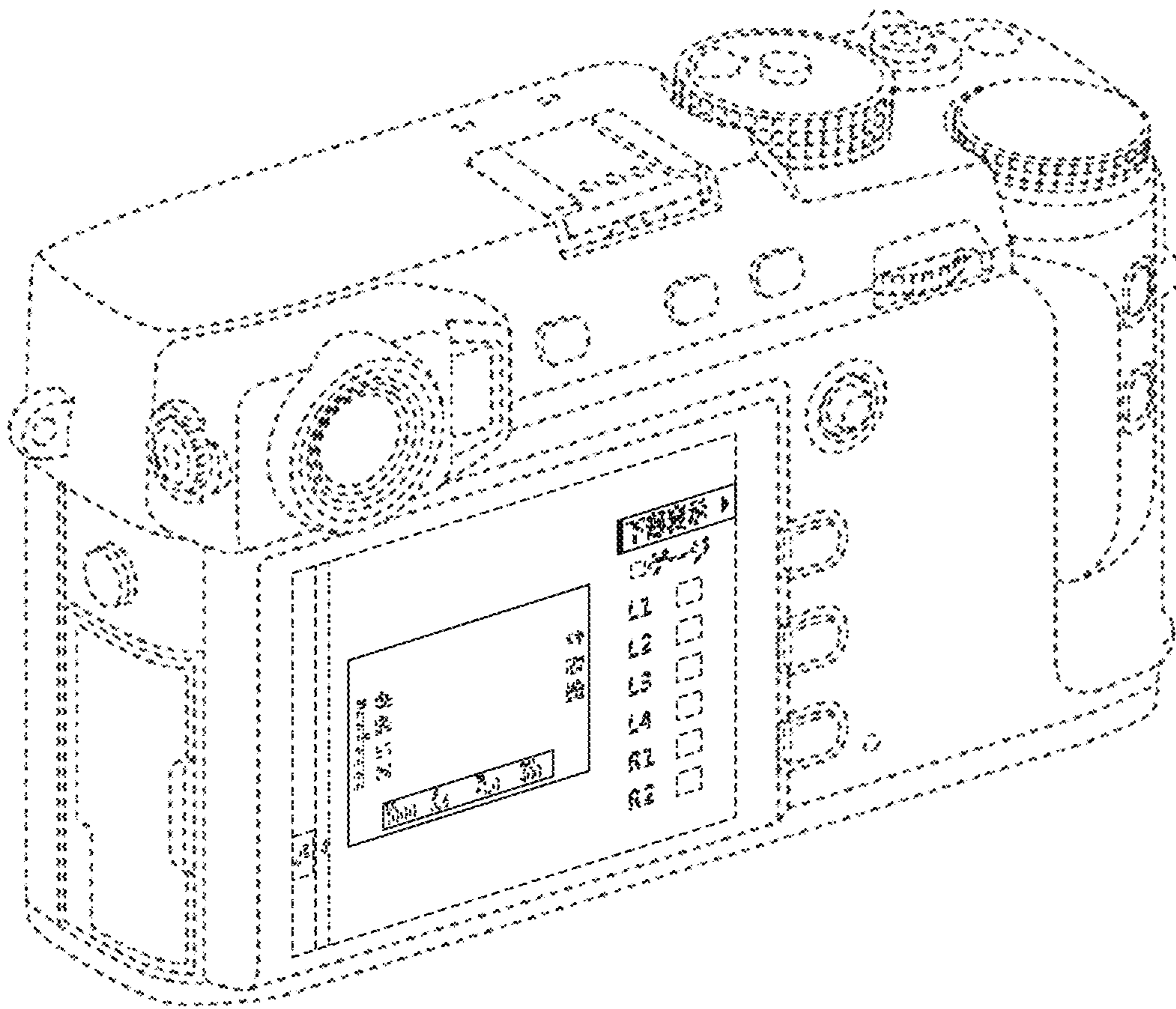

FIG.11

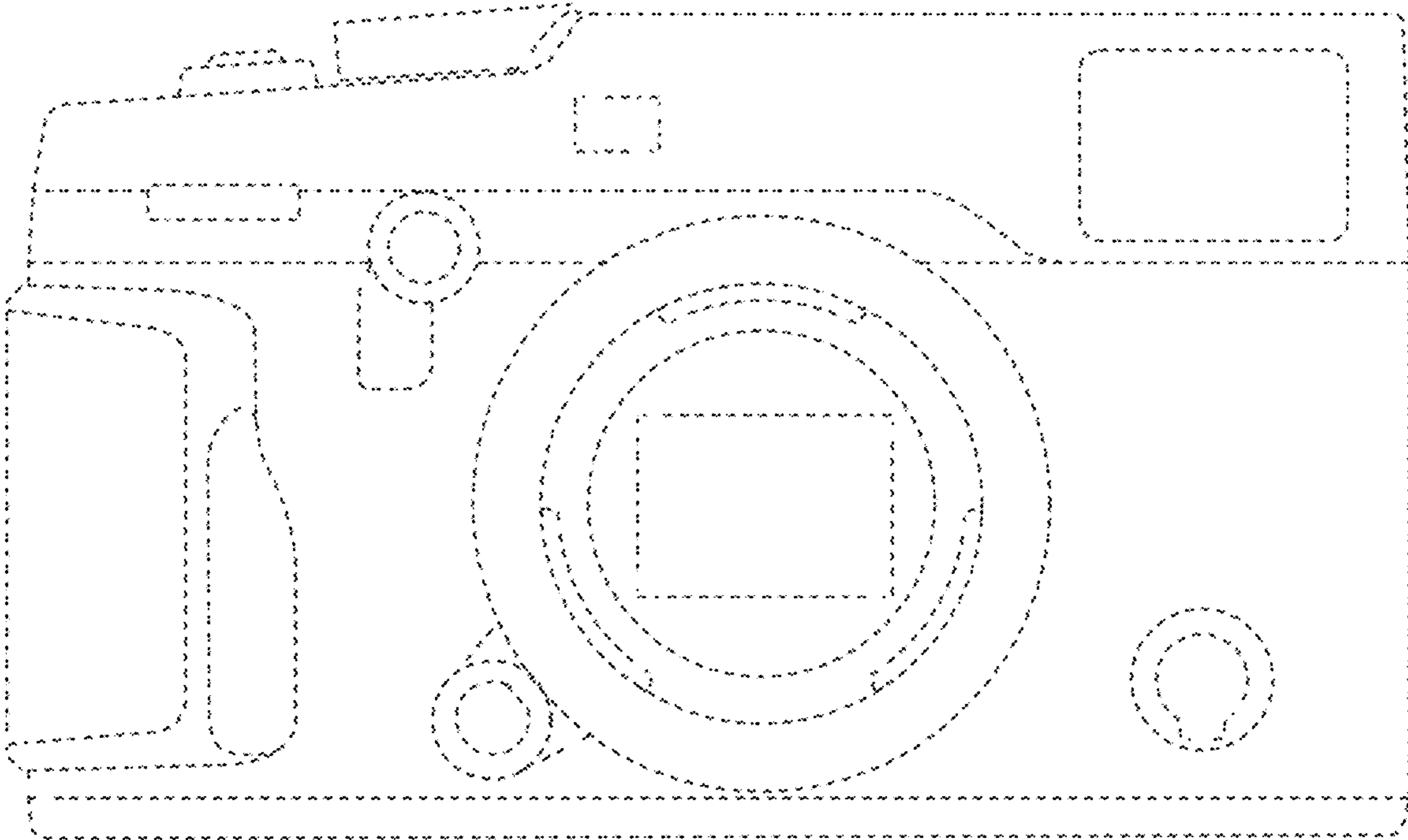

FIG.12

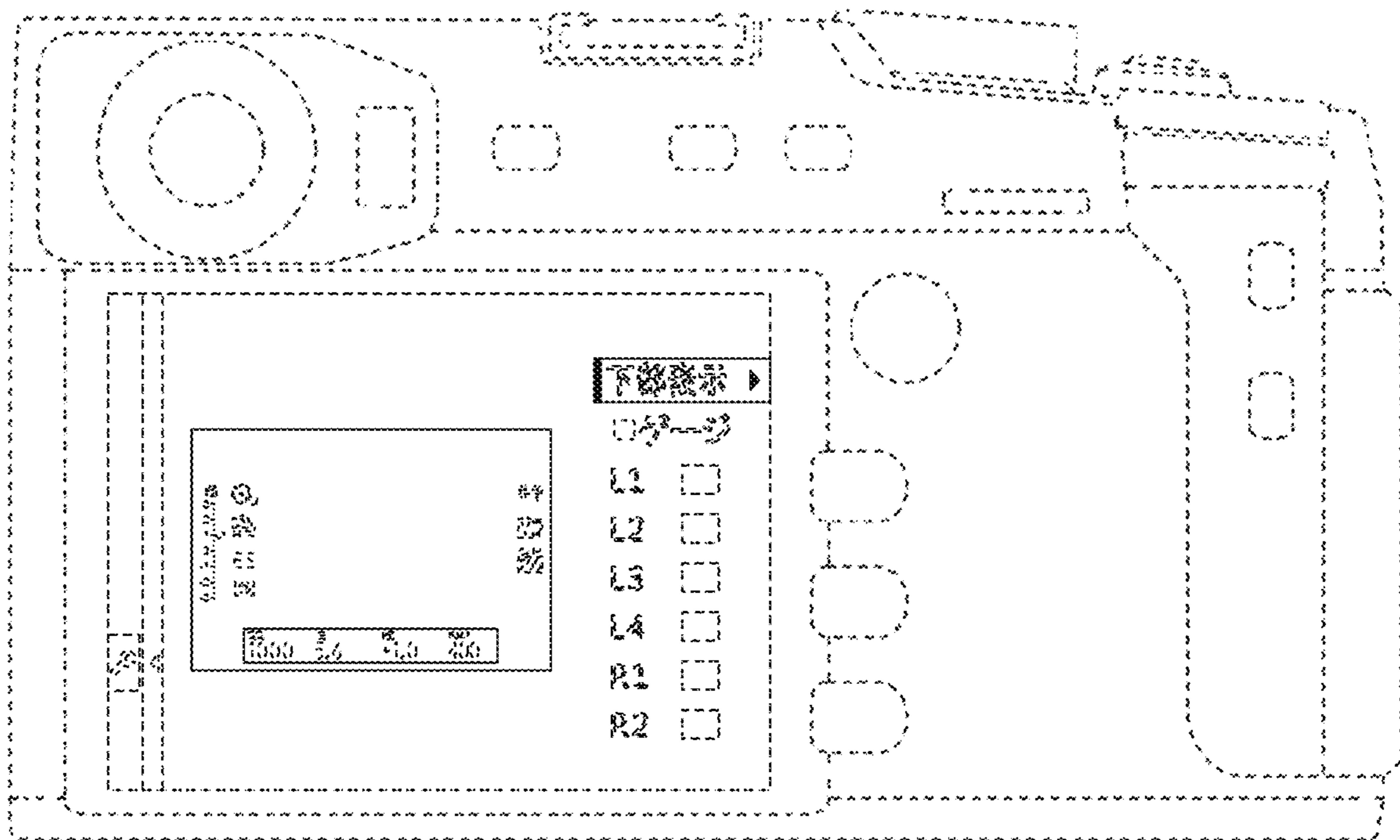

FIG. 13

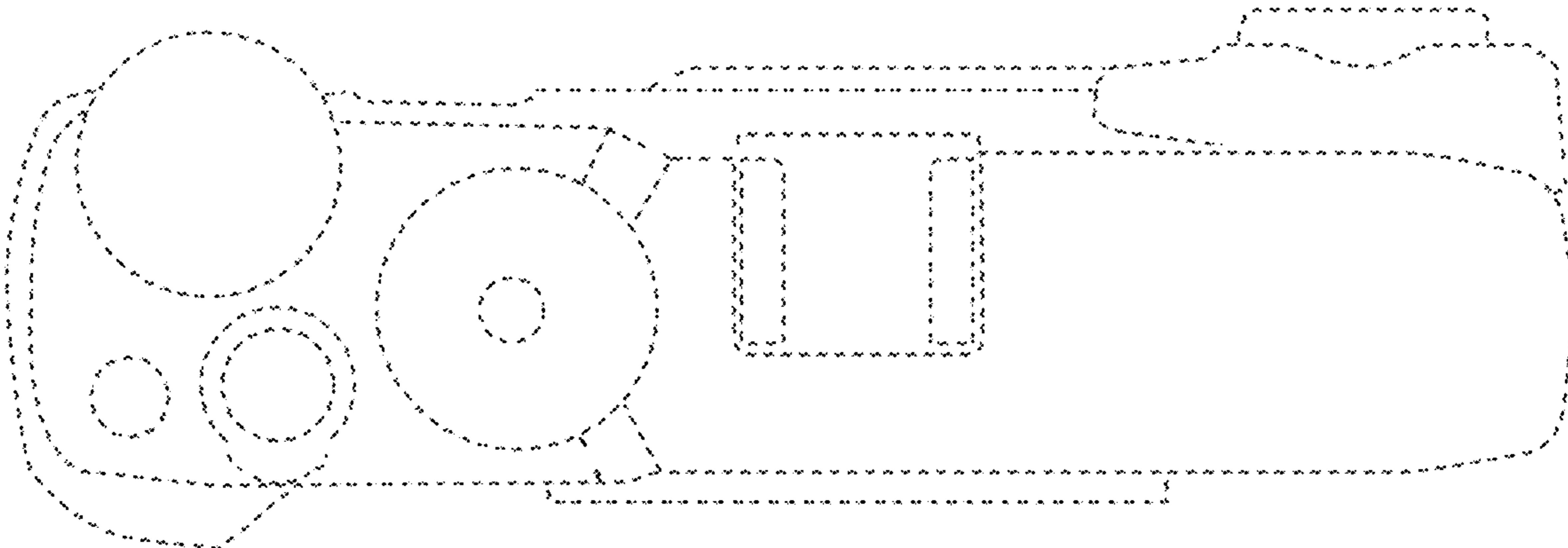

FIG.14

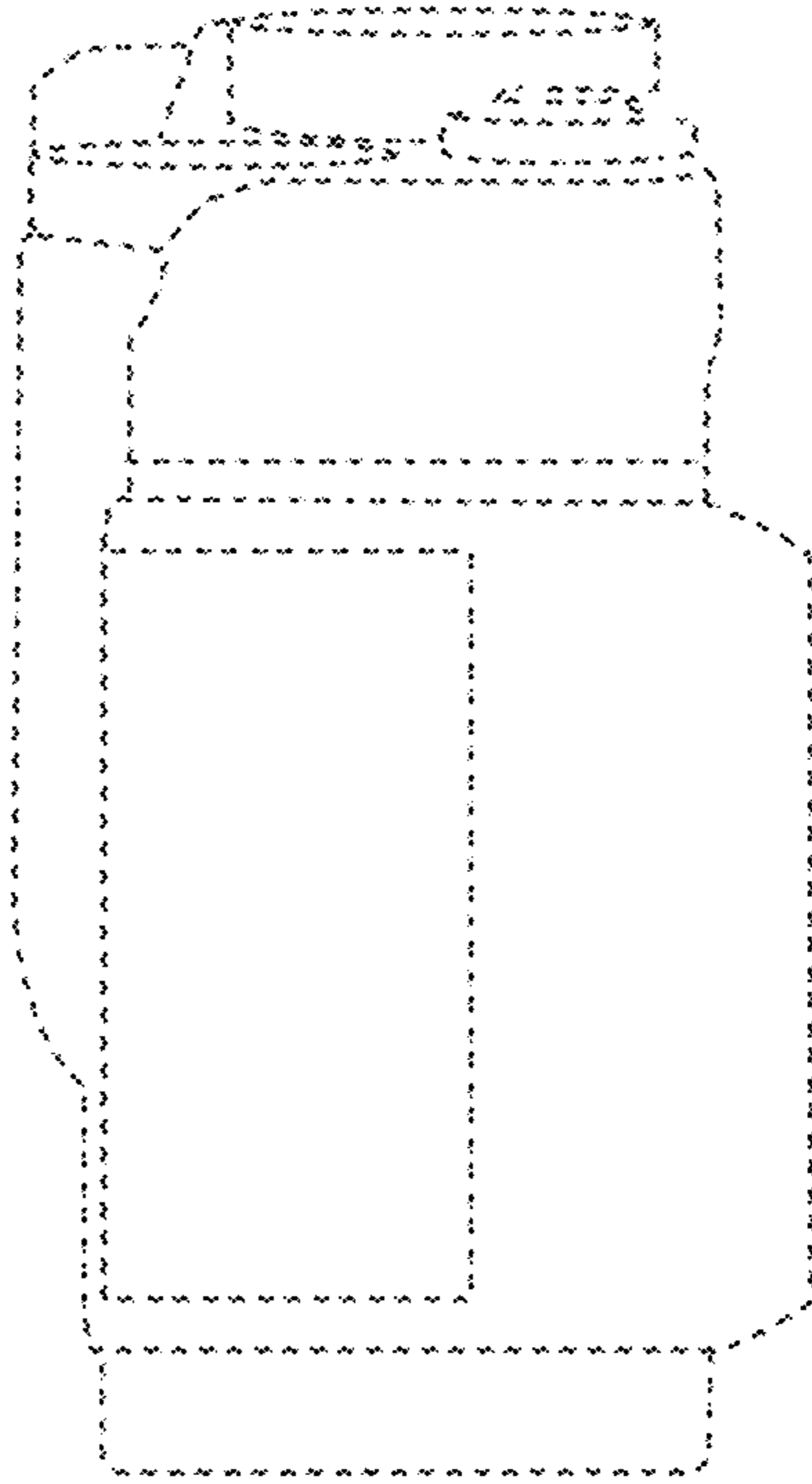

FIG. 15

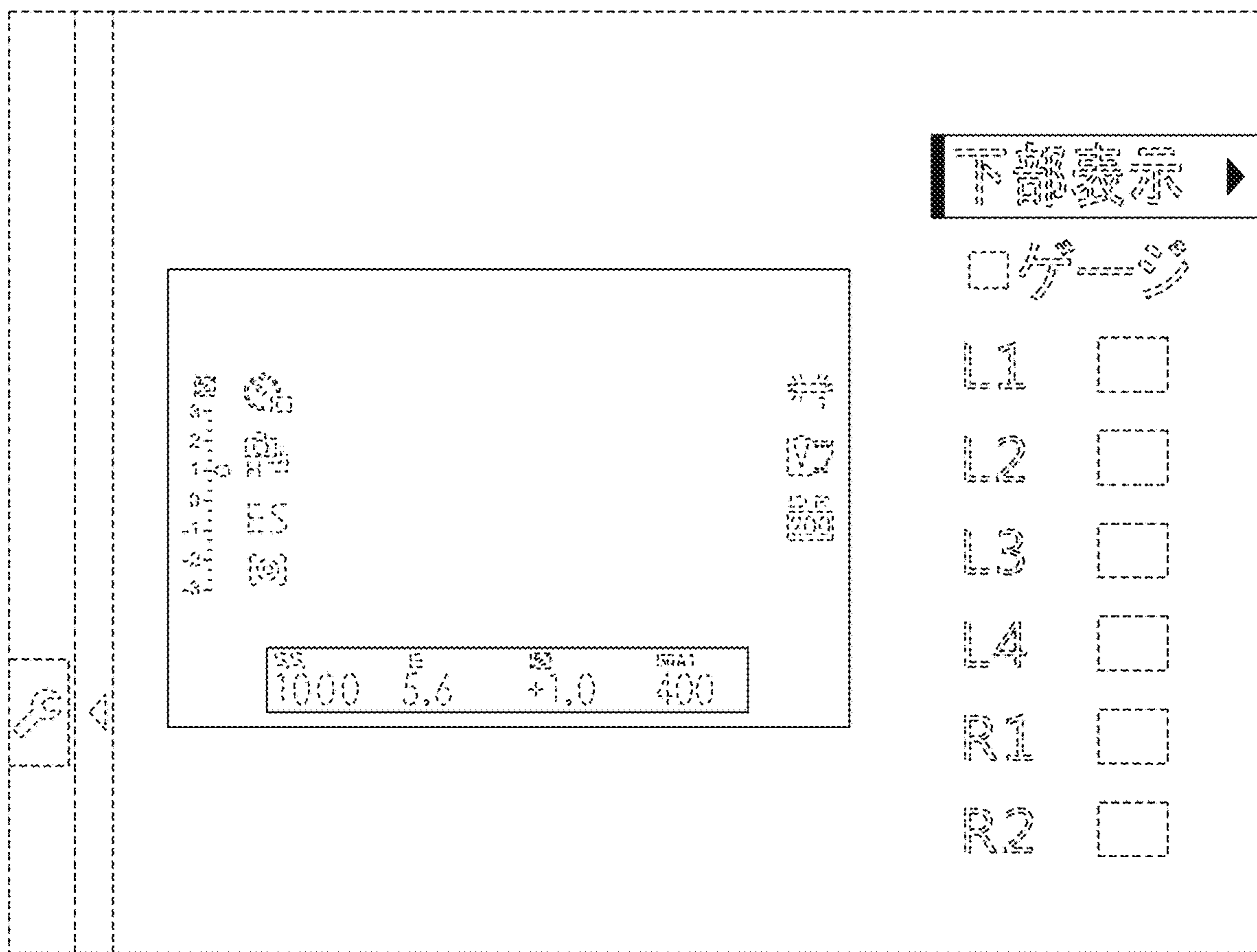

FIG.16

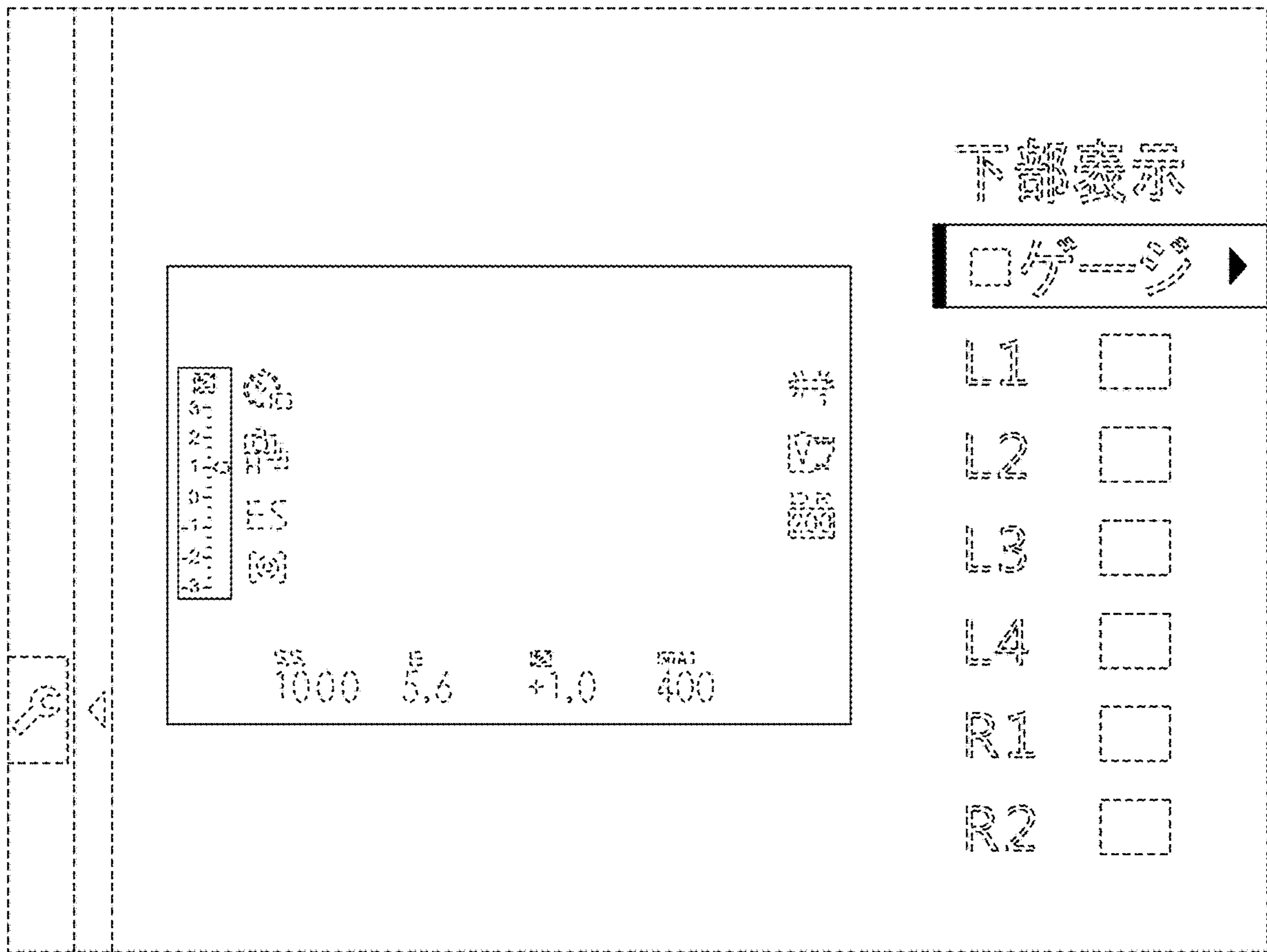

FIG.17

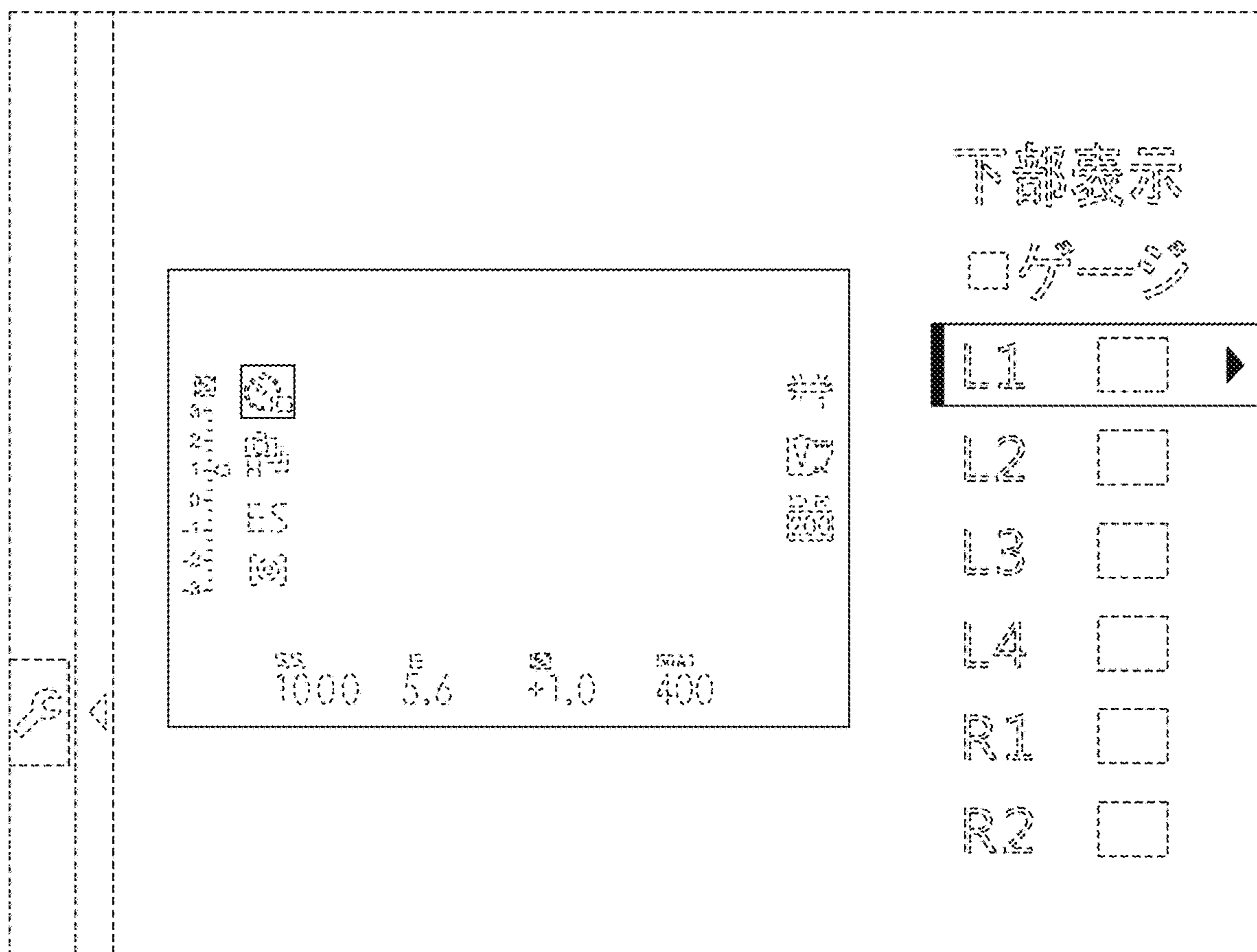

FIG.18

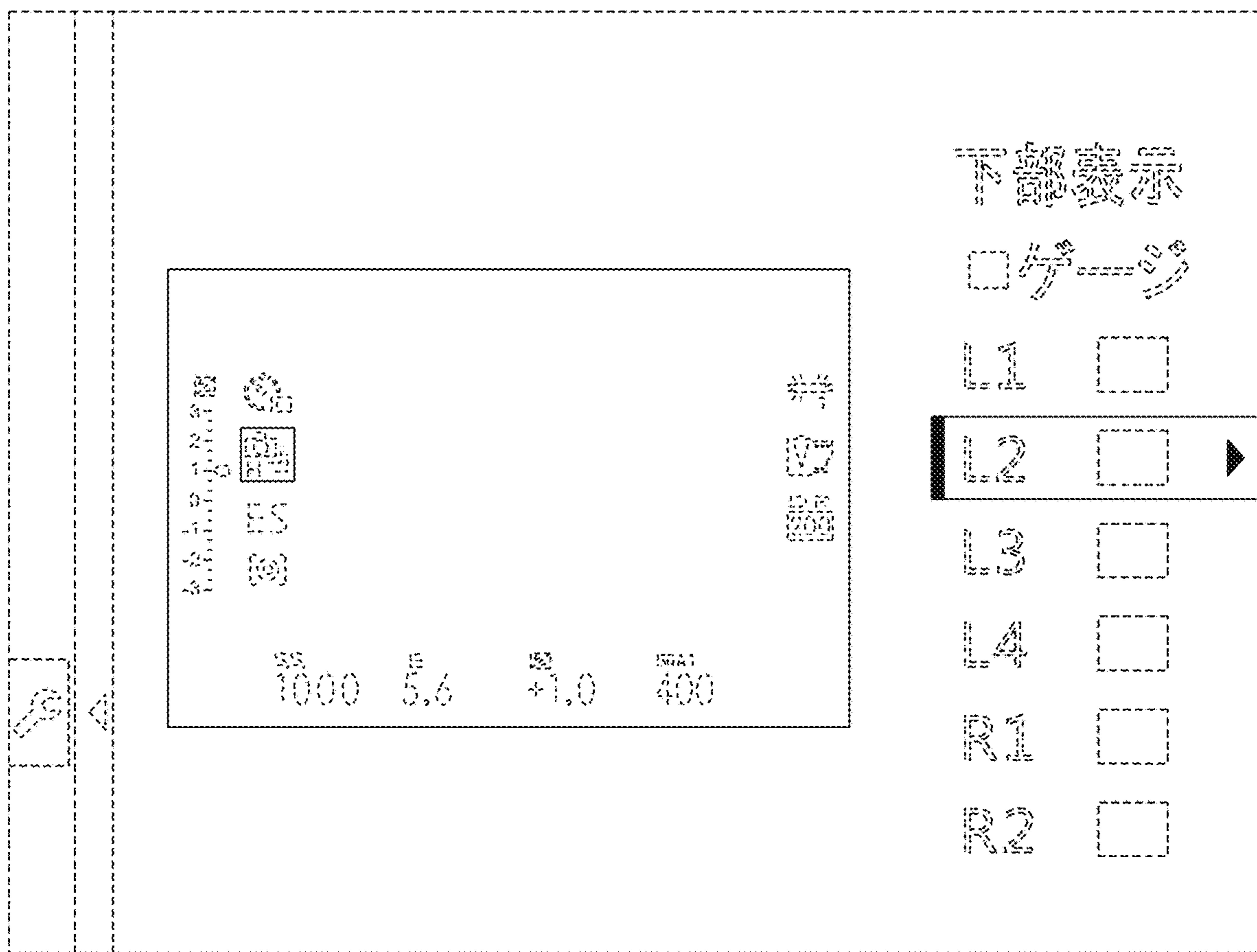

FIG. 19

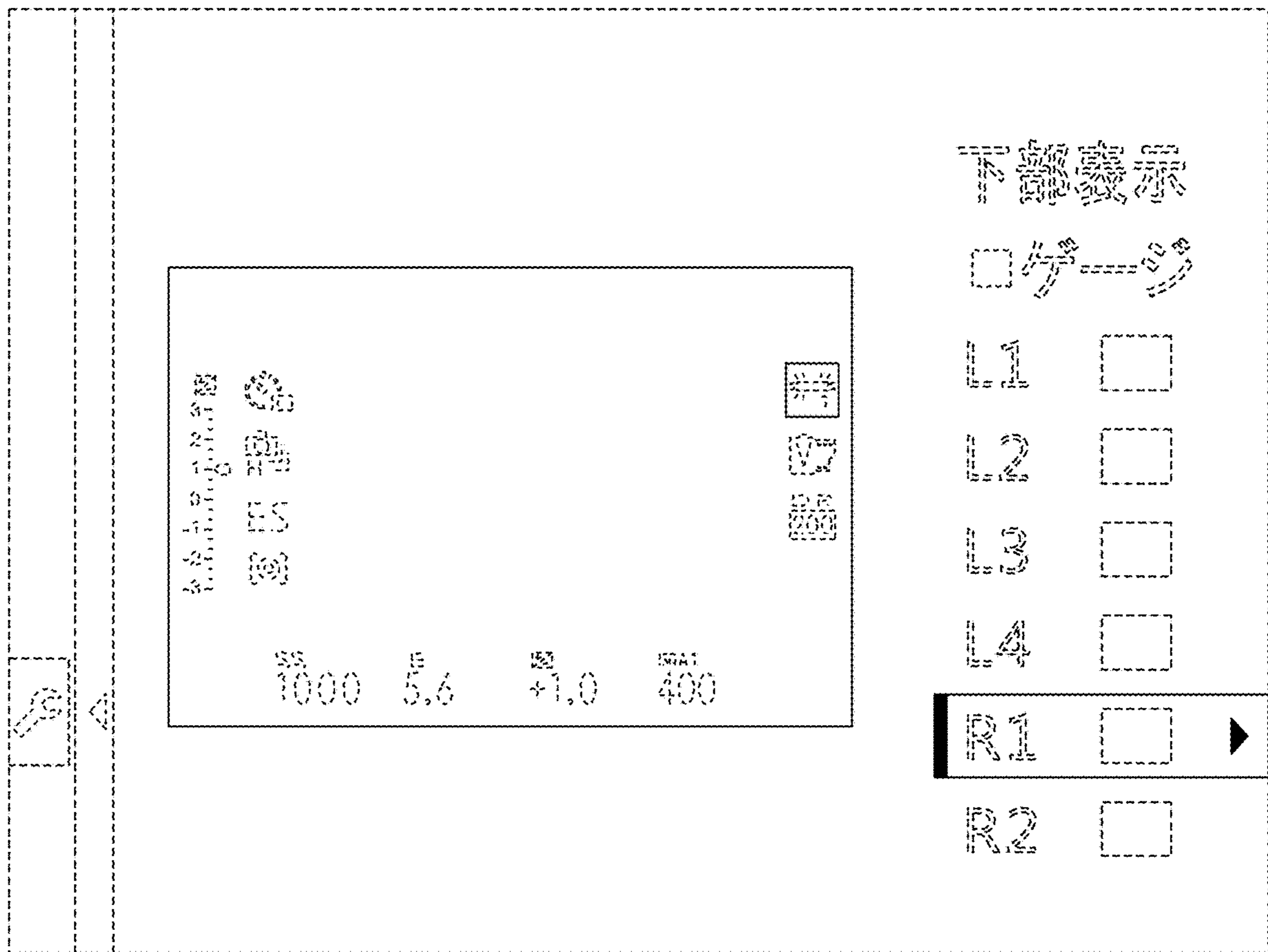

FIG. 20