



US00D914675S

(12) **United States Design Patent**
Wolff et al.

(10) **Patent No.:** **US D914,675 S**
(45) **Date of Patent:** **** Mar. 30, 2021**

(54) **LAPTOP COMPUTER**

(71) Applicant: **HEWLETT-PACKARD DEVELOPMENT COMPANY, L.P.**, Houston, TX (US)

(72) Inventors: **Stacy L. Wolff**, Houston, TX (US); **Eric Chen**, Houston, TX (US); **Chad Patrick Paris**, Houston, TX (US); **Woojin Chung**, Houston, TX (US); **Albee Lin**, Taipei (TW)

(73) Assignee: **Hewlett-Packard Development Company, L.P.**, Spring, TX (US)

(**) Term: **15 Years**

(21) Appl. No.: **29/661,195**

(22) Filed: **Aug. 24, 2018**

(51) **LOC (13) Cl.** **14-02**

(52) **U.S. Cl.**
USPC **D14/327**

(58) **Field of Classification Search**
USPC D14/315–327, 331, 336, 339–340, 450, D14/345, 203.4, 138 AB; D18/1–2, 7, D18/11, 12.2–12.3
CPC G06F 1/166; G06F 1/1613; G06F 1/1616; G06F 1/1618; G06F 1/162; G06F 1/1622; G06F 1/1624; G06F 1/1633; G06F 1/1615; G06F 1/1643; G06F 1/1654; G06F 1/1656; G06F 1/1669; G06F 1/203; G06F 1/1688; G06F 1/1601; G06F 1/1637; G06F 1/181; G06F 1/1641; G06F 1/1647; G06F 1/1649;

(Continued)

(56) **References Cited**

U.S. PATENT DOCUMENTS

5,375,076 A * 12/1994 Goodrich G06F 1/1626 361/679.17

D404,021 S * 1/1999 Nishida D14/345

(Continued)

OTHER PUBLICATIONS

Upgrade Your Digital Lifestyle with the New Samsung Notebook 9 Pen and Notebook 9 (2018), posted at Samsung US Newsroom, posting date Dec. 13, 2017. Site visited Jul. 16, 2020. URL: <https://news.samsung.com/us/2018-samsung-notebook-9-pen/> (Year: 2017).*

Primary Examiner — Kathleen L Jones
(74) *Attorney, Agent, or Firm* — HPI Patent Department

(57) **CLAIM**

We claim the ornamental design for a laptop computer, as shown and described.

DESCRIPTION

FIG. 1 is a top, front, right perspective view of the claimed design in an open configuration;
FIG. 2 is a bottom, rear, right perspective view thereof;
FIG. 3 is a front elevation view thereof;
FIG. 4 is a rear elevation view thereof;
FIG. 5 is a top plan view thereof;
FIG. 6 is a bottom plan view thereof;
FIG. 7 is a right side elevation view thereof;
FIG. 8 is a left side elevation view thereof;
FIG. 9 is a top, front, right perspective thereof in a closed configuration;
FIG. 10 is a bottom, rear, right perspective view thereof;
FIG. 11 is a front elevation view thereof;
FIG. 12 is a rear elevation view thereof;
FIG. 13 is a top plan view thereof;
FIG. 14 is a bottom plan view thereof;
FIG. 15 is a right side elevation view thereof; and,
FIG. 16 is a left side elevation view thereof.

Broken lines in the drawings that are formed by equal length dashes show portions of the laptop computer that form no part of the claimed design. In addition, broken lines in the drawings that are formed by unequal length dashes (i.e., dash-dot) define bounds of the claimed design and form no part thereof.

1 Claim, 14 Drawing Sheets

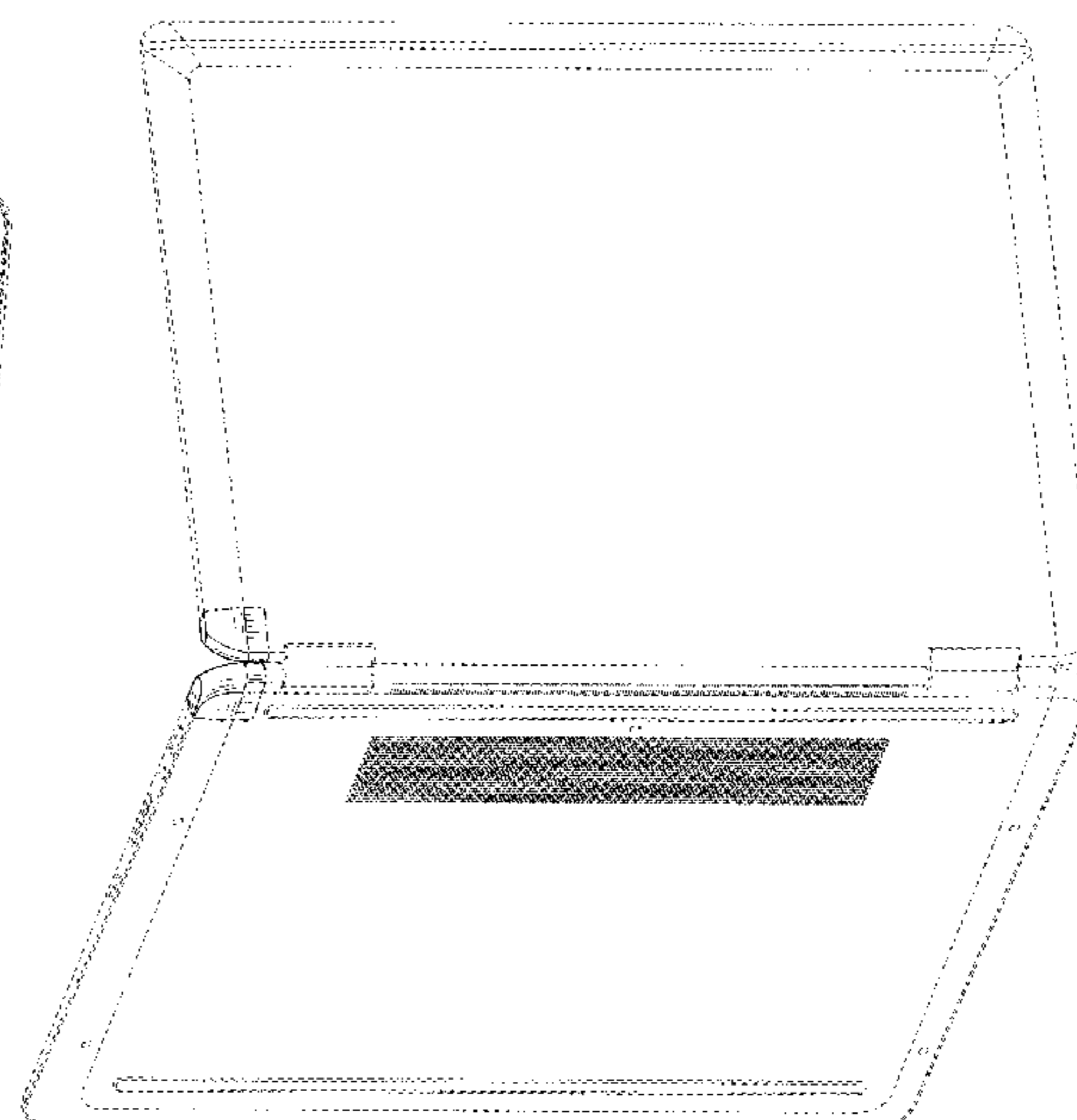
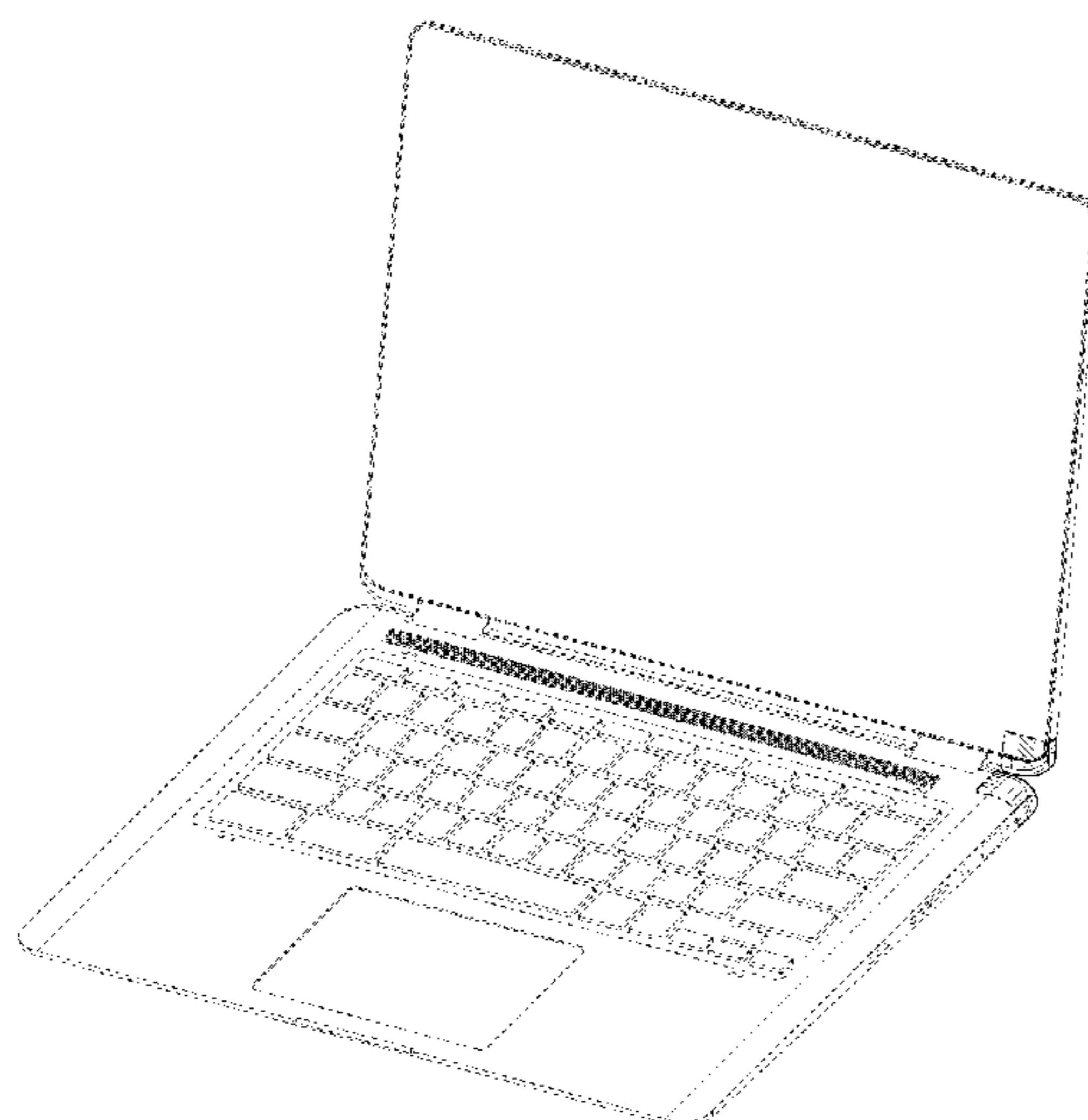

(58) **Field of Classification Search**
 CPC G06F 1/165; G06F 1/1652; G06F 1/1681;
 H05K 5/0047; H05K 5/0052
 See application file for complete search history.

(56) **References Cited**

U.S. PATENT DOCUMENTS

D432,531 S	*	10/2000	Lee	D14/318
D453,756 S	*	2/2002	Kamegi	D14/318
D479,840 S	*	9/2003	Lu	D14/318
D492,677 S	*	7/2004	Shimizu	D14/318
D593,981 S	*	6/2009	Boucquey	D14/138 AB
D627,341 S	*	11/2010	Yoon	D14/315
D640,659 S	*	6/2011	Wun	D14/138 AB
D647,874 S	*	11/2011	Park	D14/138 AB
D648,695 S	*	11/2011	Wun	D14/138 AB
D651,206 S	*	12/2011	Kim	D14/315
D661,300 S	*	6/2012	Kim	D14/327
D673,559 S	*	1/2013	Yang	D14/318
D678,872 S	*	3/2013	Lee	D14/315
D682,240 S	*	5/2013	Hirota	D14/138 AB

D697,063 S	*	1/2014	Lee	D14/315
D703,202 S	*	4/2014	Jung	D14/327
D707,643 S	*	6/2014	Park	D14/138 AB
D708,610 S	*	7/2014	Ahn	D14/345
D729,228 S	*	5/2015	Kawai	D14/318
D729,792 S	*	5/2015	Kurimoto	D14/320
D743,390 S	*	11/2015	Lyles	D14/315
D744,475 S	*	12/2015	Myung	D14/315
D751,524 S	*	3/2016	Nagao	D14/138 AB
D753,647 S	*	4/2016	Mehandjiysky	D14/315
D763,249 S	*	8/2016	Lee	D14/315
D791,120 S	*	7/2017	Leonard	D14/316
D806,702 S	*	1/2018	Senatori	D14/316
D807,345 S	*	1/2018	Senatori	D14/316
D807,875 S	*	1/2018	Senatori	D14/316
D808,951 S	*	1/2018	Jung	D14/316
D810,071 S	*	2/2018	Hishiki	D14/318
D813,860 S	*	3/2018	Doczy	D14/315
D826,924 S	*	8/2018	Lee	D14/315
D829,710 S	*	10/2018	Seoc	D14/315
D830,465 S	*	10/2018	Suetake	D21/330
D842,856 S	*	3/2019	Lam	D14/345
D865,757 S	*	11/2019	Townsend	D14/327

* cited by examiner

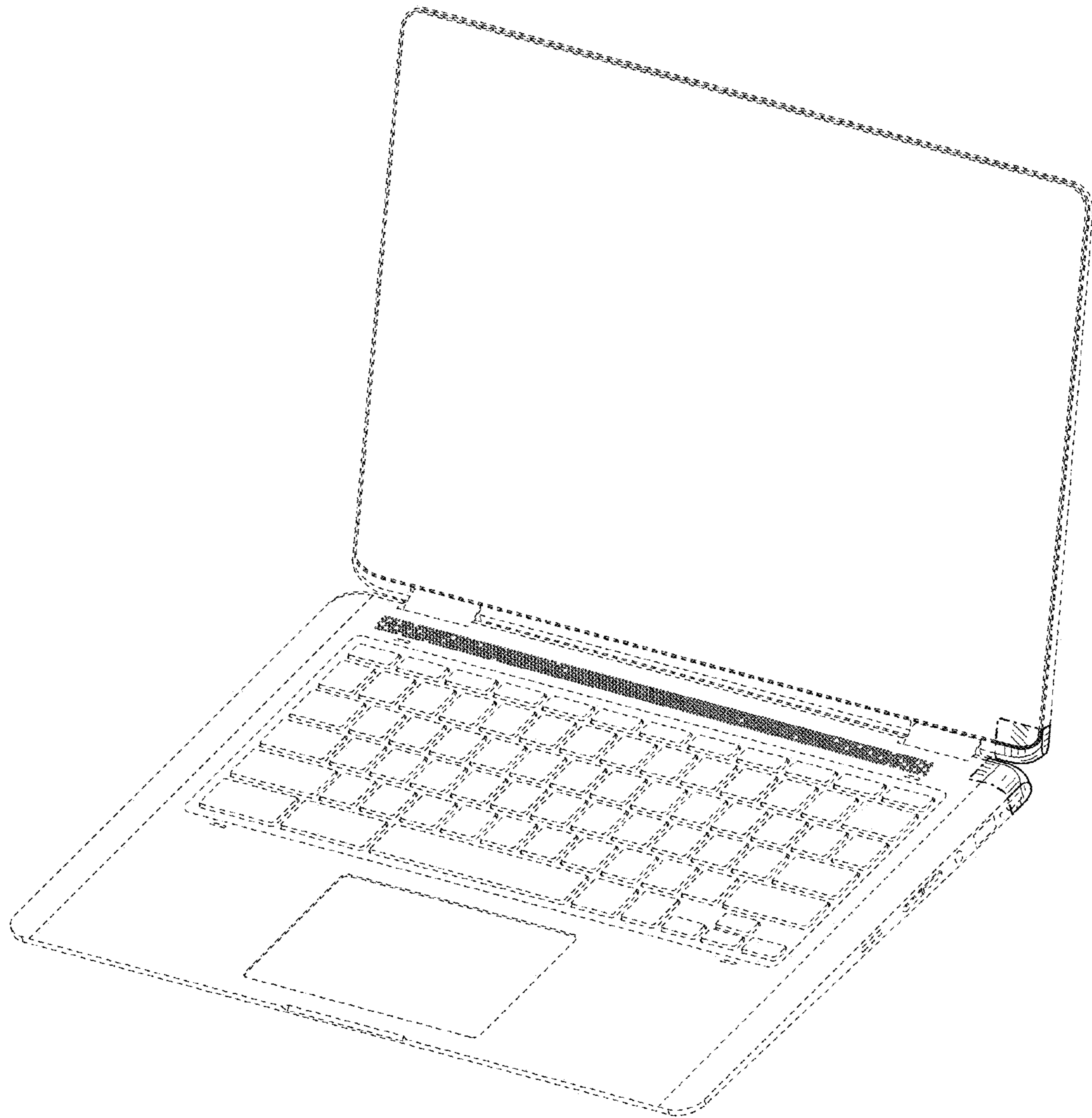

FIG. 1

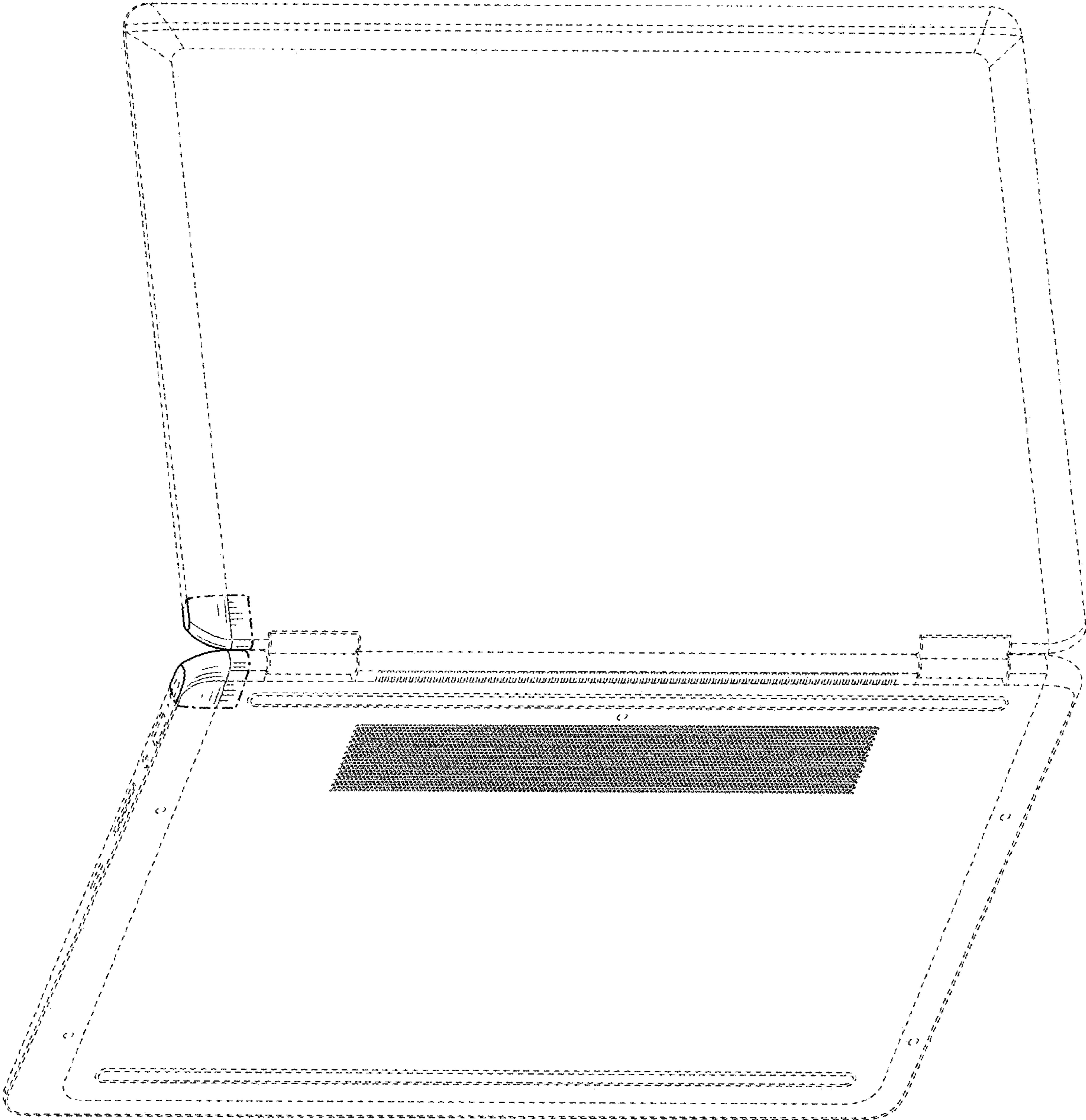

FIG. 2

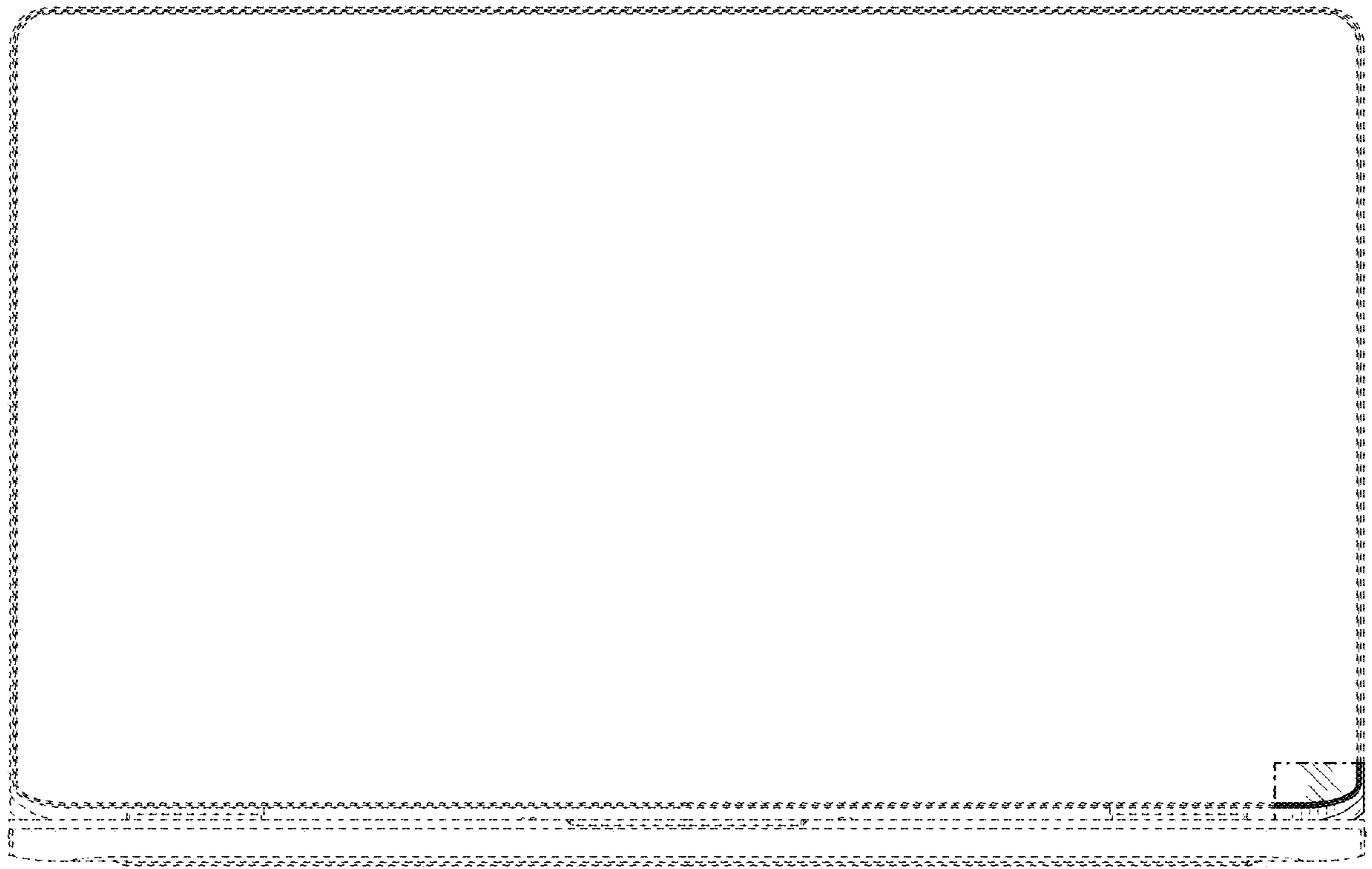

FIG. 3



FIG. 4

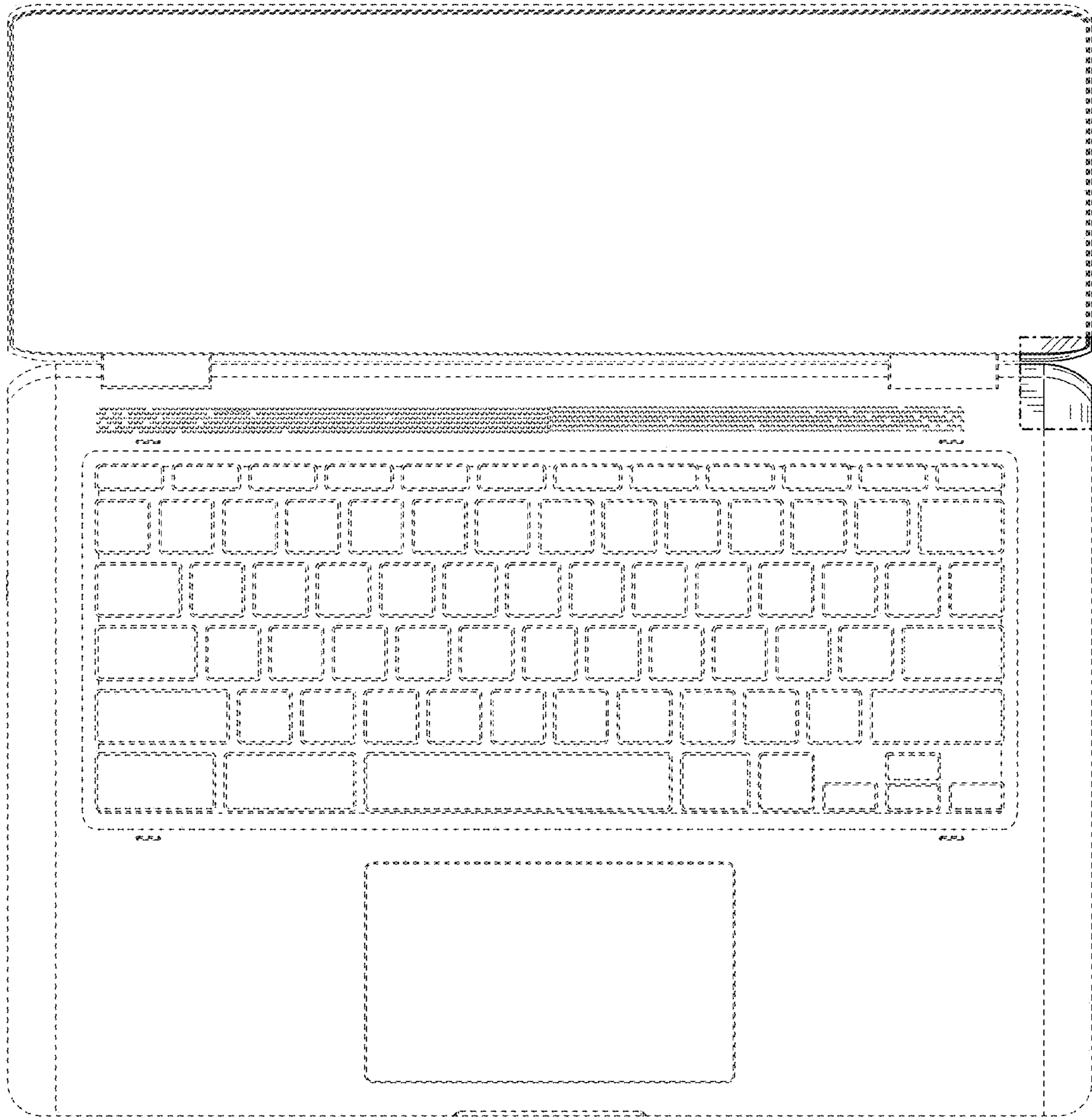

FIG. 5

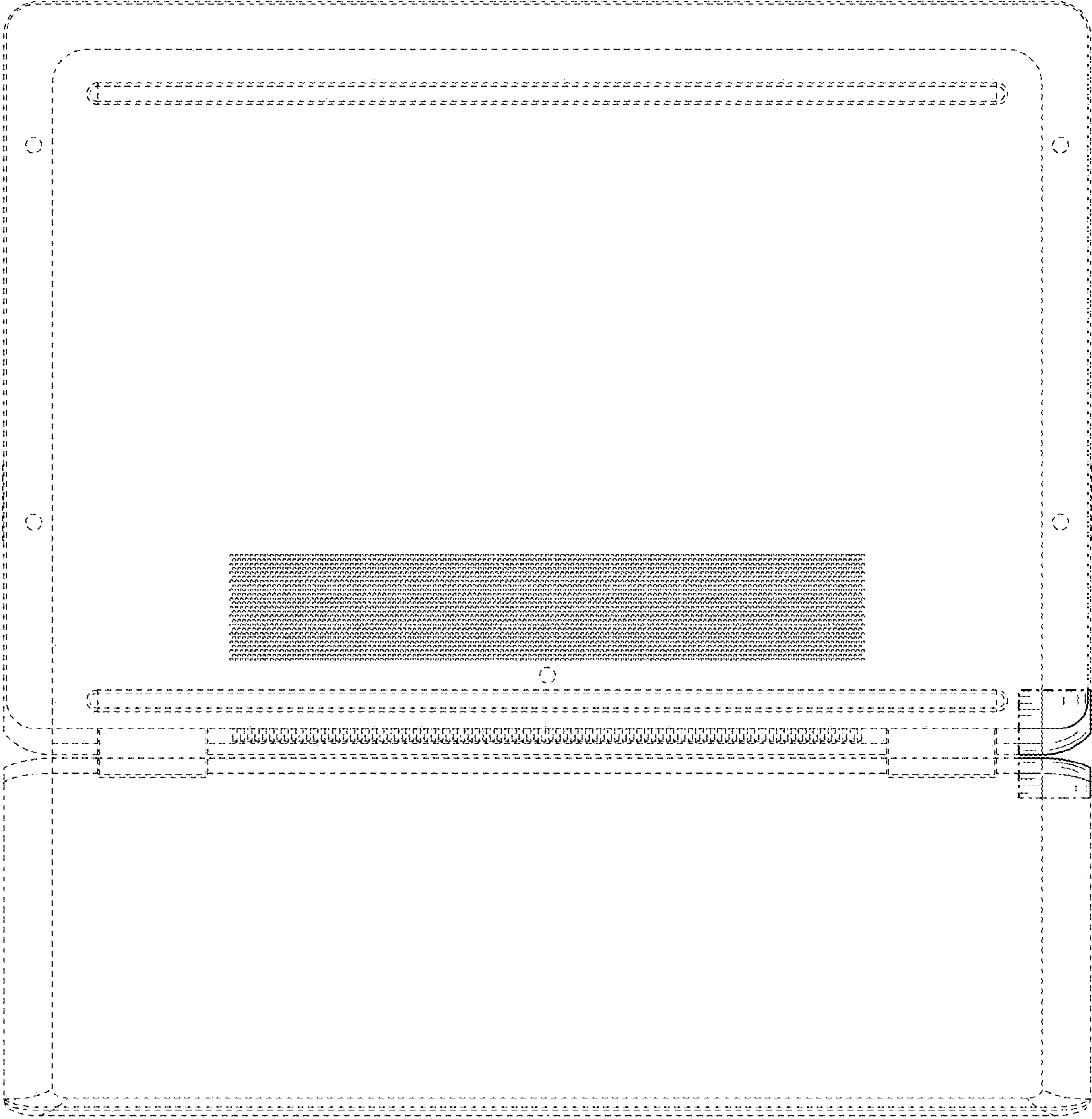

FIG. 6

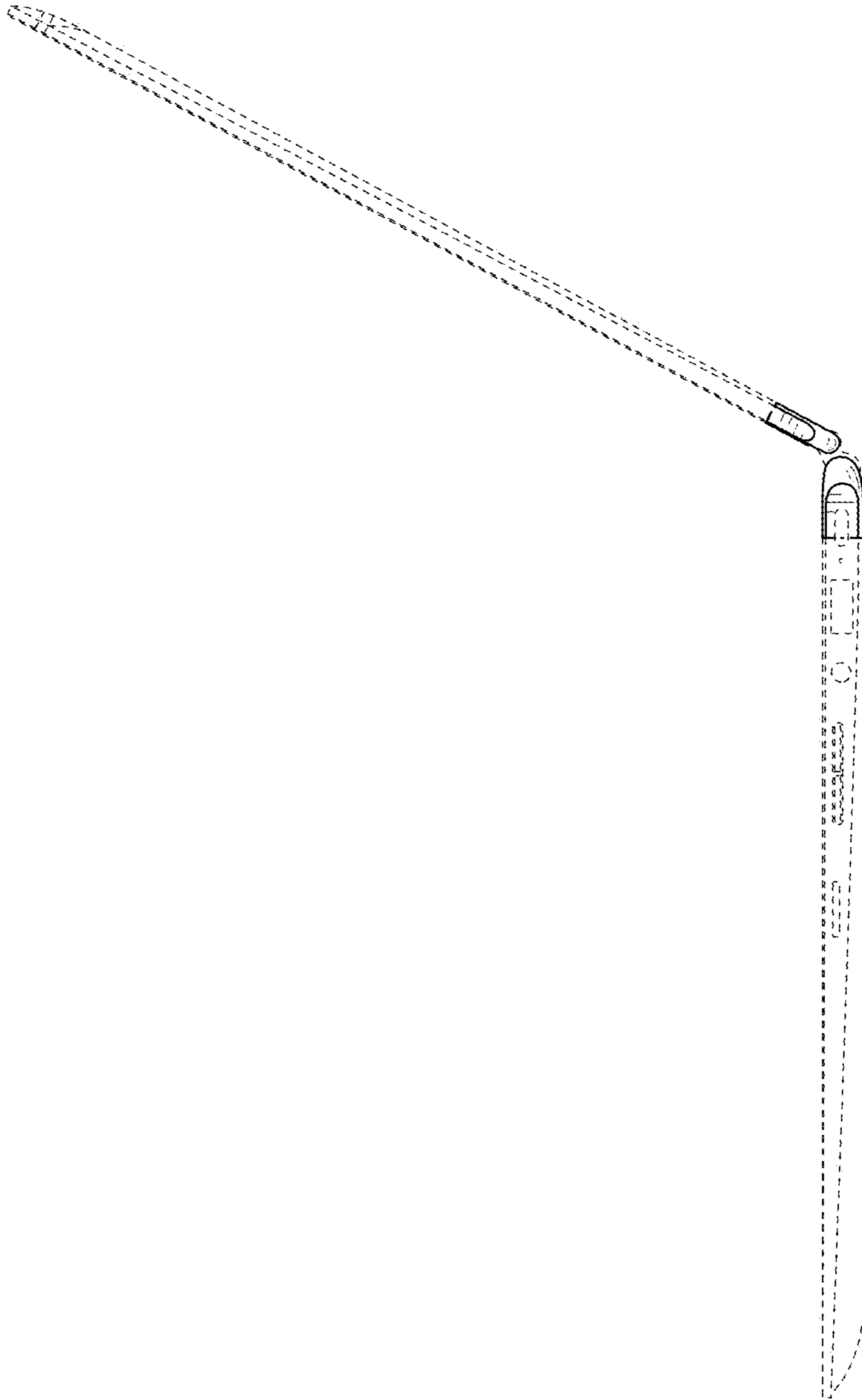

FIG. 7

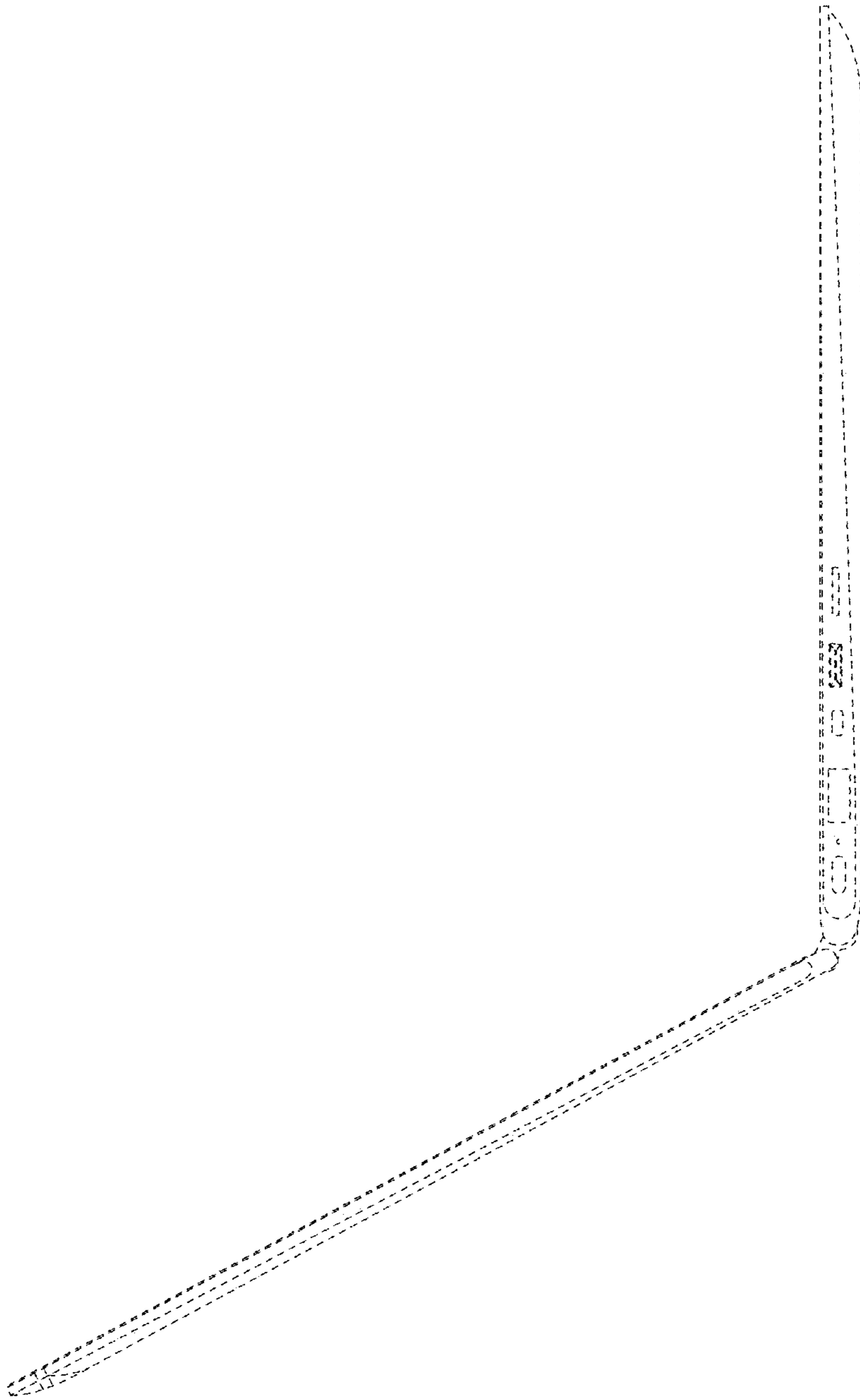

FIG. 8

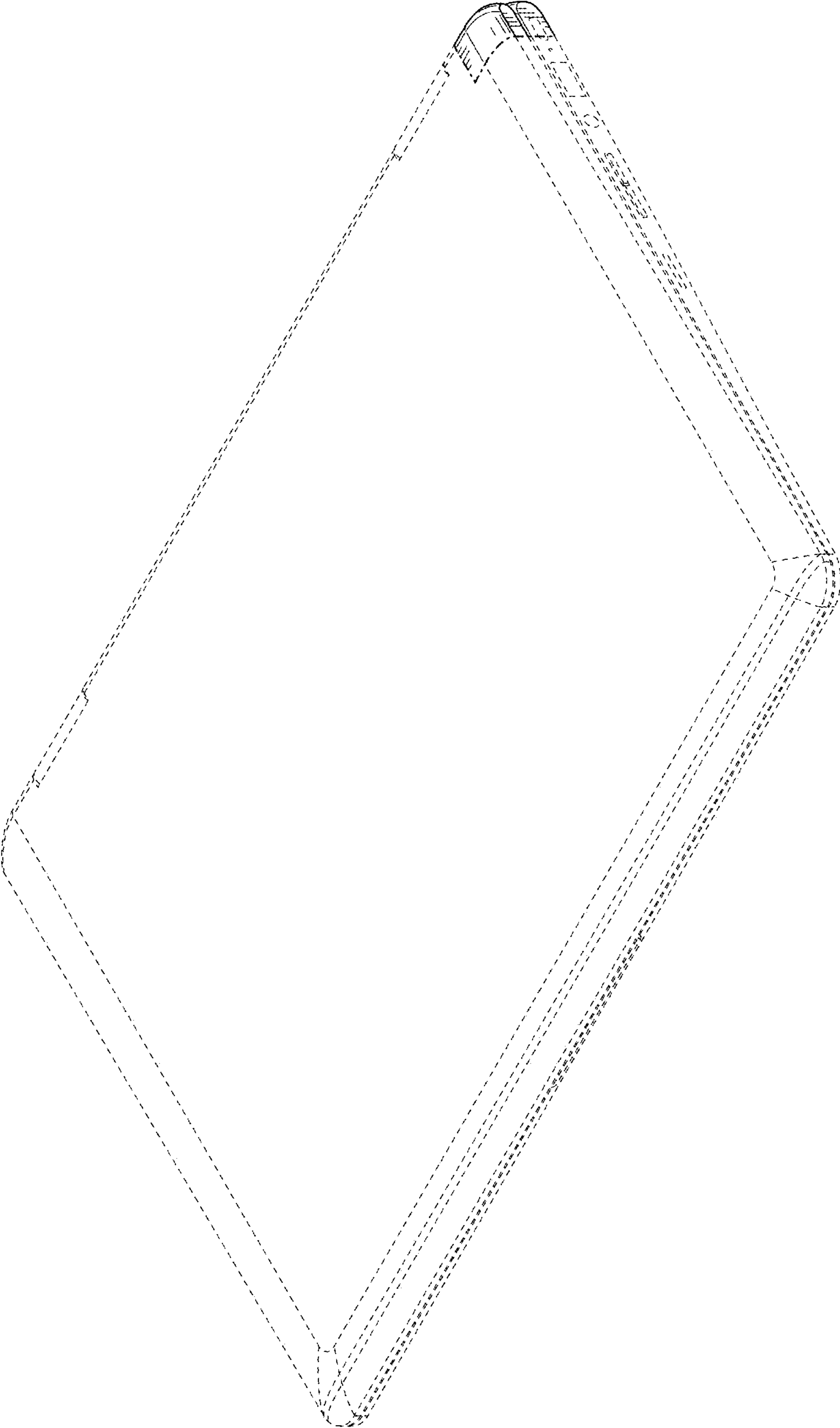

FIG. 9

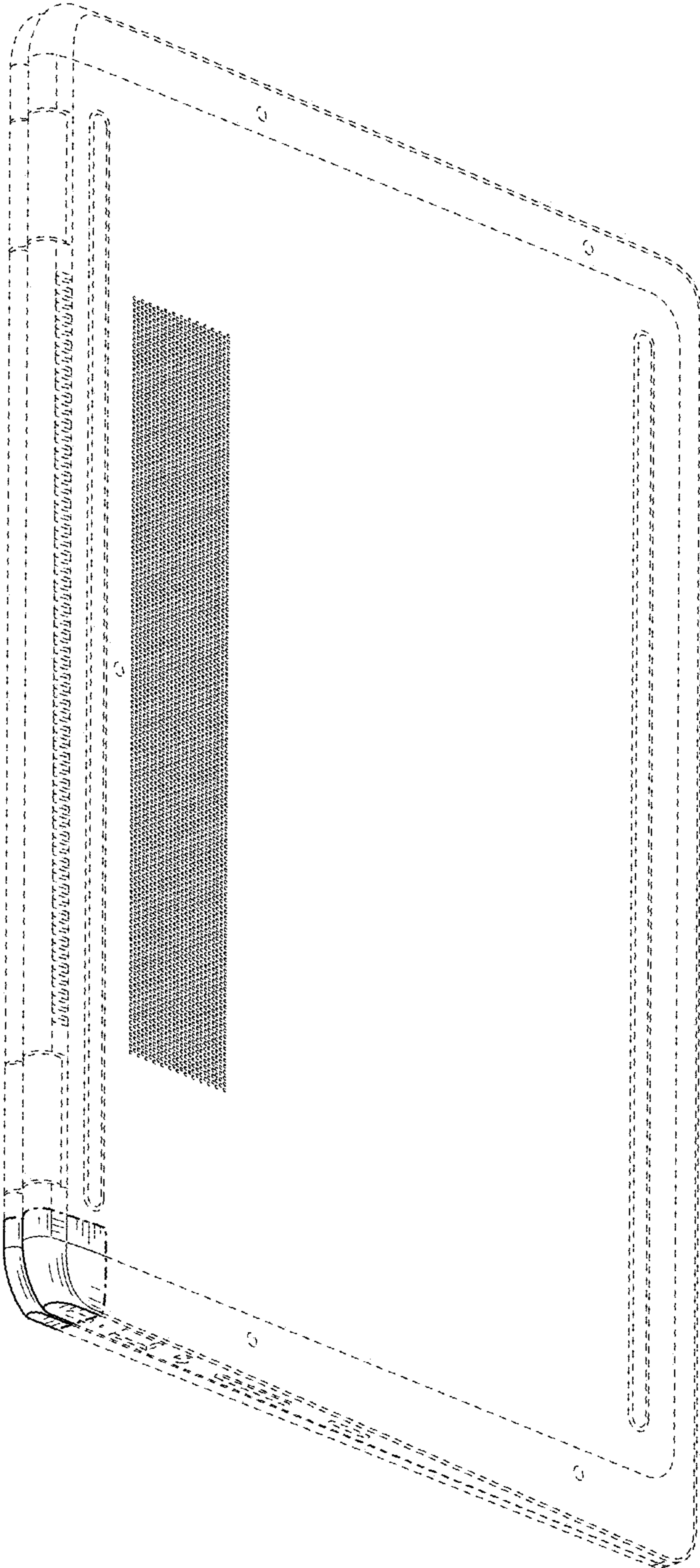

FIG. 10

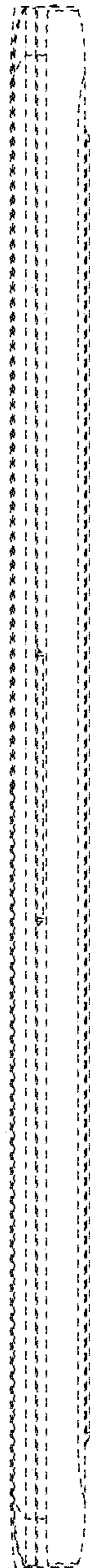

FIG. 11

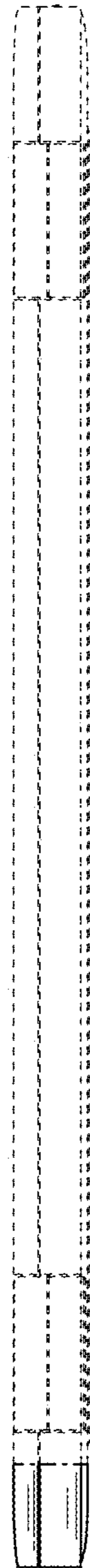

FIG. 12

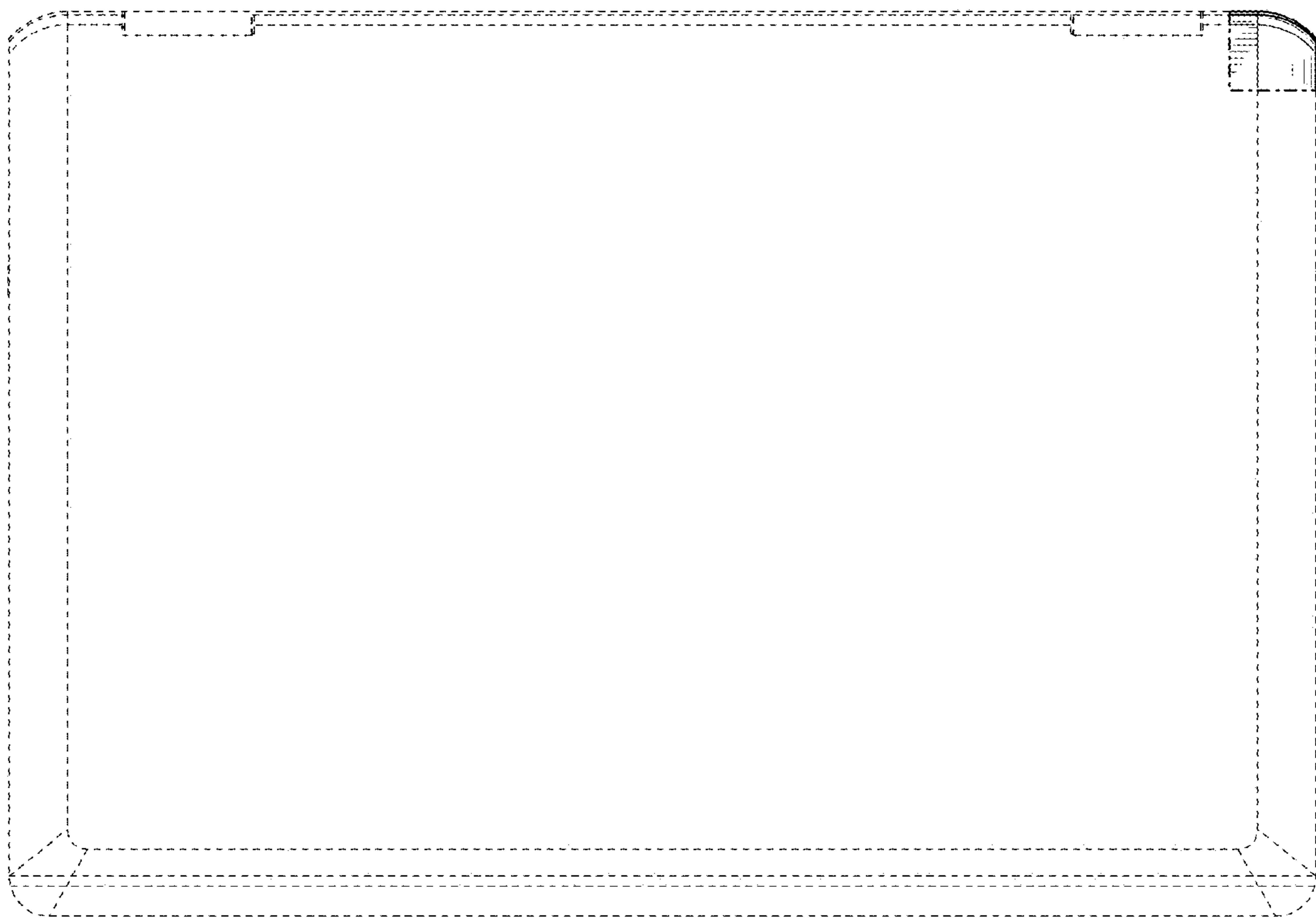

FIG. 13

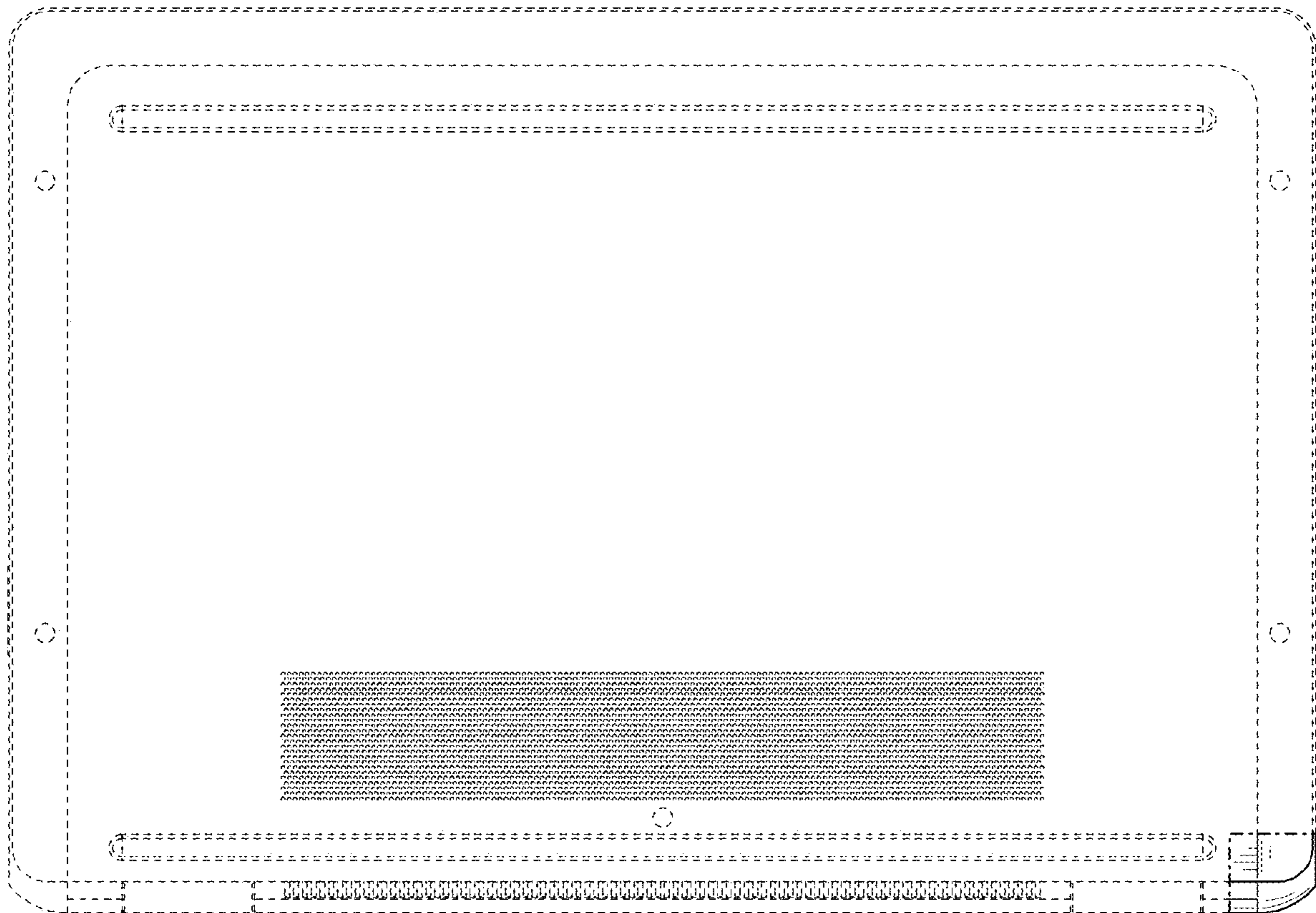

FIG. 14

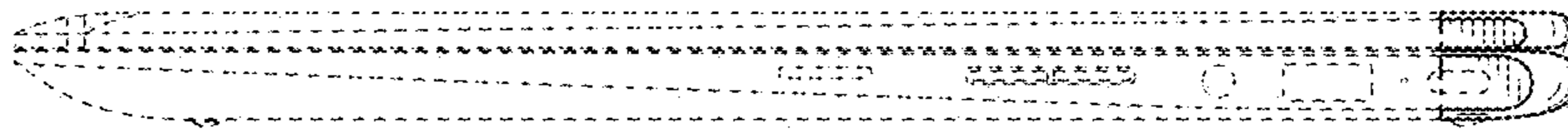

FIG. 15

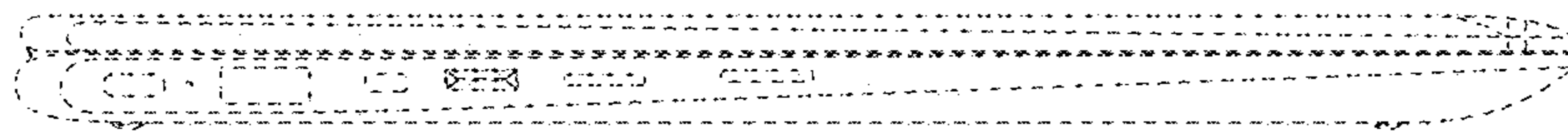

FIG. 16