



US00D914669S

(12) **United States Design Patent**
Lim

(10) **Patent No.:** **US D914,669 S**
(45) **Date of Patent:** **** Mar. 30, 2021**

(54) **LAPTOP COMPUTER**

(71) Applicant: **Lenovo (Beijing) Co., Ltd.**, Beijing (CN)
(72) Inventor: **Ghwang-Hyun Lim**, Beijing (CN)
(73) Assignee: **Lenovo (Beijing) Co., Ltd.**, Beijing (CN)
(**) Term: **15 Years**
(21) Appl. No.: **35/507,695**
(22) Filed: **Jun. 25, 2019**

(80) **Hague Agreement Data**

Int. Filing Date: **Jun. 25, 2019**
Int. Reg. No.: **DM/203798**
Int. Reg. Date: **Jun. 25, 2019**
Int. Reg. Pub. Date: **Nov. 8, 2019**

(30) **Foreign Application Priority Data**

Dec. 25, 2018 (CN) 201830755217.2
Dec. 25, 2018 (CN) 201830755874.7

(51) **LOC (13) Cl.** **14-02**

(52) **U.S. Cl.**
USPC **D14/315**; D14/327

(58) **Field of Classification Search**
USPC D14/315-323, 326, 327, 331, 334, 335,
D14/339, 340; D18/1, 2, 7, 12.2, 12.3
CPC G06F 1/166; G06F 1/1613; G06F 1/1616;
G06F 1/1618; G06F 1/162; G06F 1/1622;
G06F 1/1624; G06F 1/1633; G06F
1/1615; G06F 1/1643; G06F 1/1654;
G06F 1/1656; G06F 1/1669; G06F 1/203;
G06F 1/1688; G06F 1/1601; G06F
1/1637; G06F 1/181;

(Continued)

(56) **References Cited**

U.S. PATENT DOCUMENTS

D493,785 S * 8/2004 Andre D14/318
D558,752 S * 1/2008 Andre D14/315
D571,364 S * 6/2008 Andre D14/315

(Continued)

OTHER PUBLICATIONS

Screenshot @ minute 4:27 of video: YouTube: Review: Apple's Late-2016 MacBook Pro with Touch Bar. Nov. 14, 2016; one page. Found online Sep. 3, 2020 at <https://www.youtube.com/watch?v=-FYELMBsPPE> (Year: 2016).*

Primary Examiner — Robert M. Spear
(74) *Attorney, Agent, or Firm* — Oppedahl Patent Law Firm

(57) **CLAIM**

The ornamental design for a laptop computer, as shown and described.

DESCRIPTION

- 1.,3. Laptop computer
- 1.1 : Front
- 1.2 : Back
- 1.3 : Left
- 1.4 : Enlarged
- 1.5 : Right
- 1.6 : Top
- 1.7 : Bottom
- 3.1 : Front
- 3.2 : Back
- 3.3 : Left
- 3.4 : Enlarged
- 3.5 : Right
- 3.6 : Top
- 3.7 : Bottom
- 3.8 : Perspective

The design shown in FIGS. 1.1 through 1.7 discloses the laptop computer in a closed state and the design shown in FIGS. 3.1 through 3.8 discloses the laptop computer in an opened state. The broken lines shown in the drawings illustrate portions of the laptop computer that form no part of the claimed design.

1 Claim, 15 Drawing Sheets

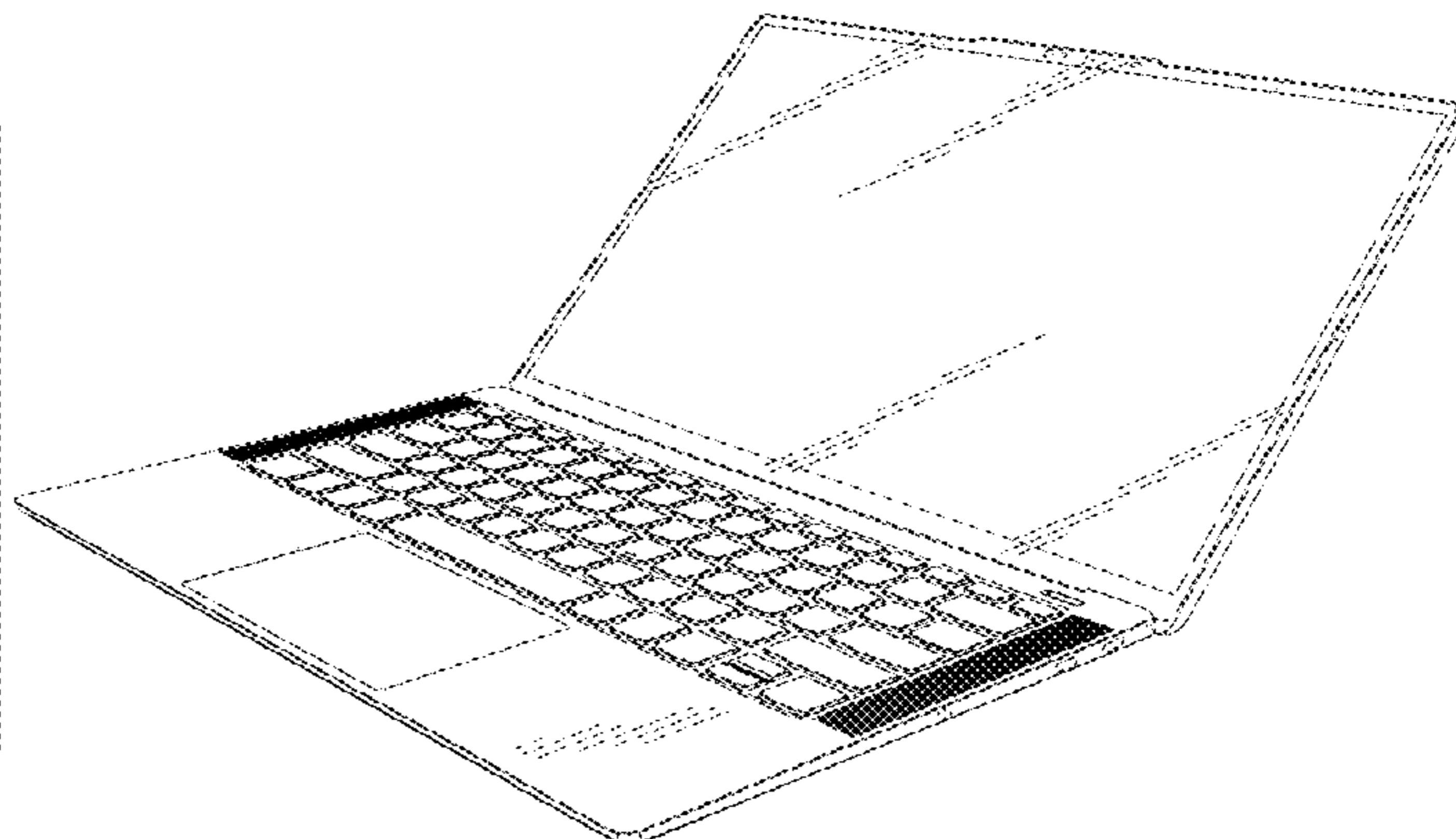

(58) **Field of Classification Search**
CPC ... G06F 1/1686; H05K 5/0047; H05K 5/0052
See application file for complete search history.

(56) **References Cited**

U.S. PATENT DOCUMENTS

D572,247 S * 7/2008 Andre D14/315
D581,411 S * 11/2008 Kumano G06F 1/1613
D14/318
D589,507 S * 3/2009 Andre D14/315
D604,294 S * 11/2009 Andre D14/318
D611,469 S * 3/2010 Andre D14/315
D613,284 S * 4/2010 Solomon D14/327
D616,881 S * 6/2010 Andre D14/318
D625,717 S * 10/2010 Andre D14/318
D661,693 S * 6/2012 Andre D14/315
D715,289 S * 10/2014 Heck D14/327
8,947,874 B2 * 2/2015 Andre G06F 1/1613
361/679.55
D753,645 S * 4/2016 Tian D14/315
D786,857 S * 5/2017 Tian D14/315
D803,825 S * 11/2017 Akana D14/315
D806,701 S * 1/2018 Akana D14/315
D816,661 S * 5/2018 Akana D14/315
D825,552 S * 8/2018 Andre D14/315
D874,457 S * 2/2020 Oakley D14/327
D888,708 S * 6/2020 Akana D14/318
D890,168 S * 7/2020 Akana D14/318
2010/0091442 A1 * 4/2010 Theobald G06F 1/1679
361/679.09

* cited by examiner

1.1

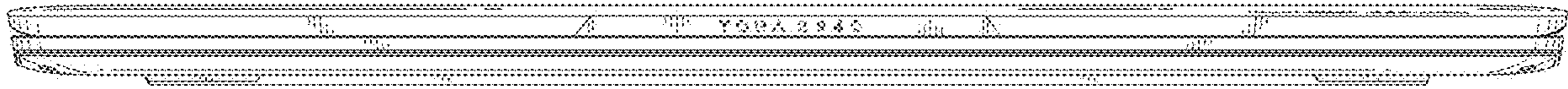

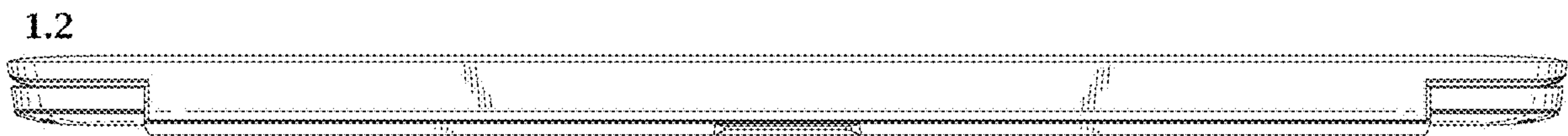

1.3

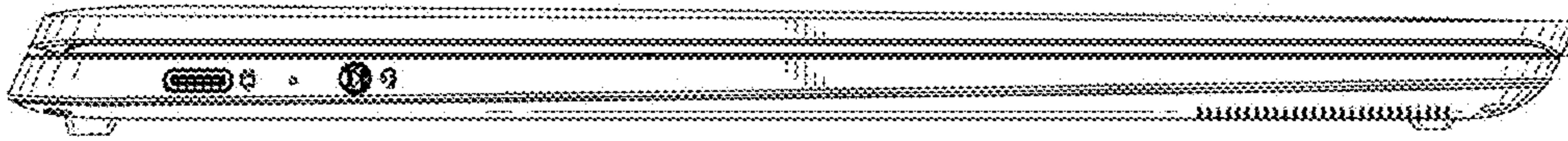

1.4

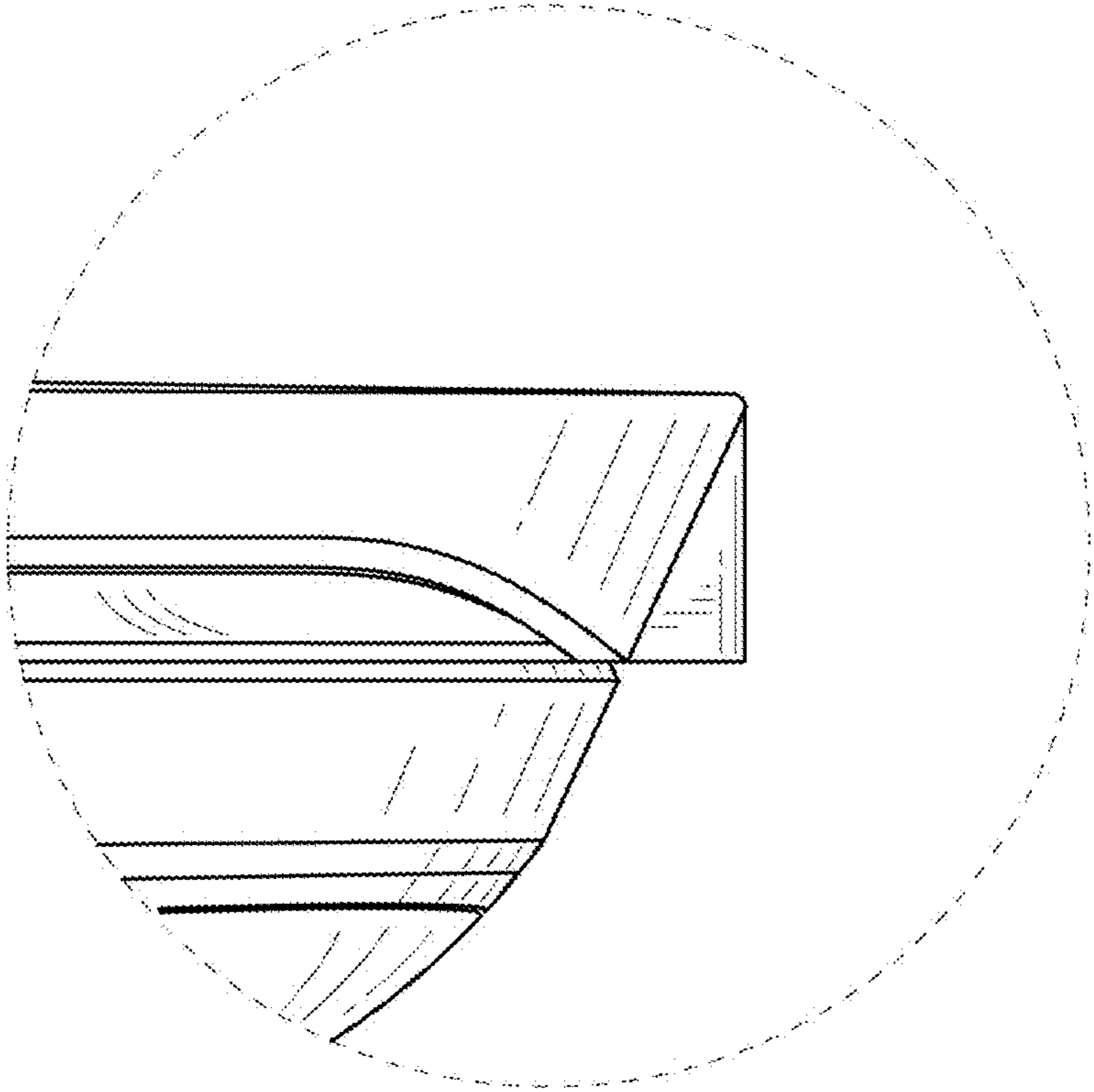

1.5

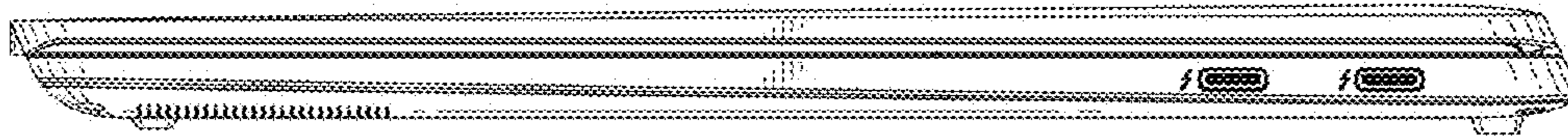

1.6

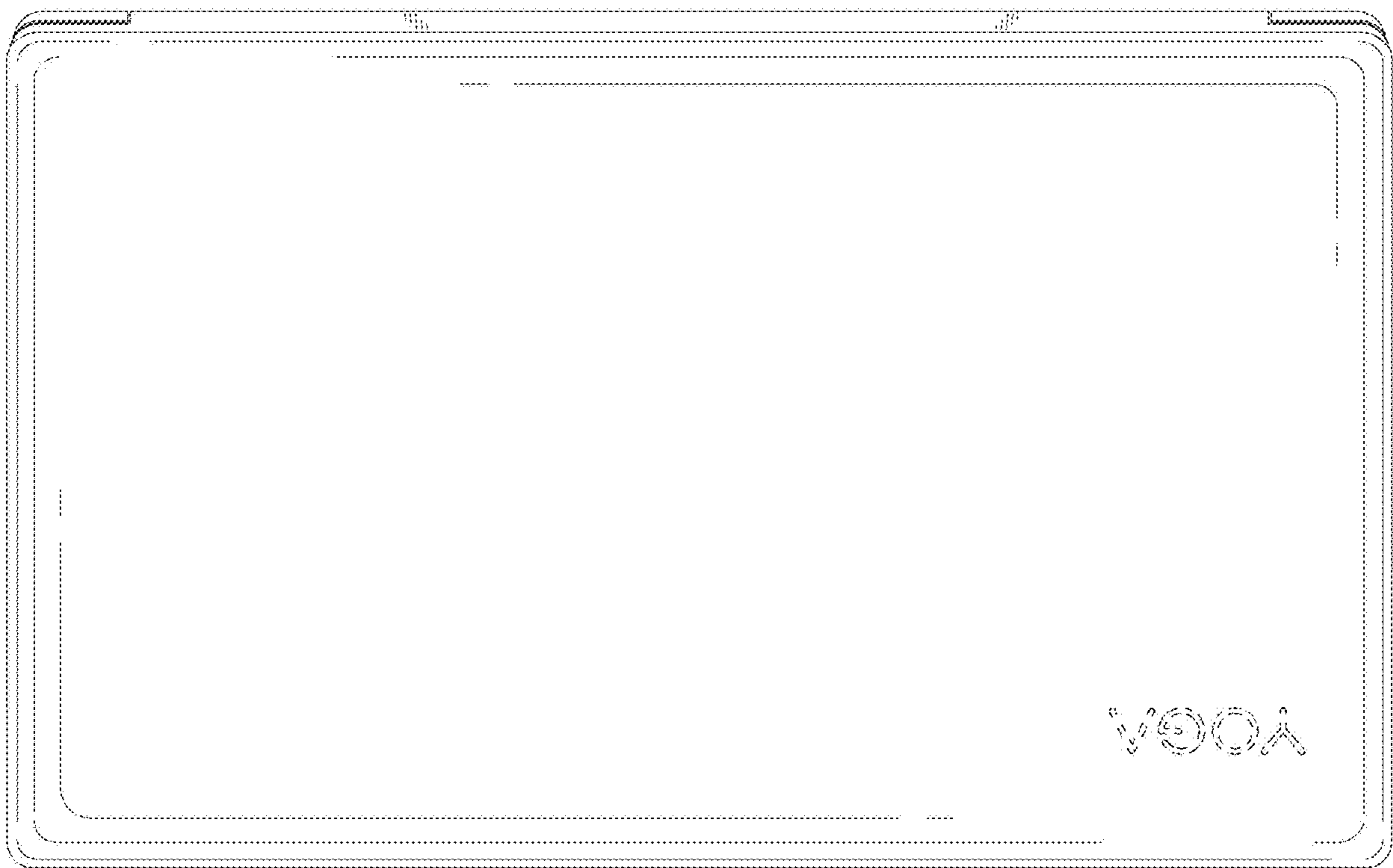

1.7

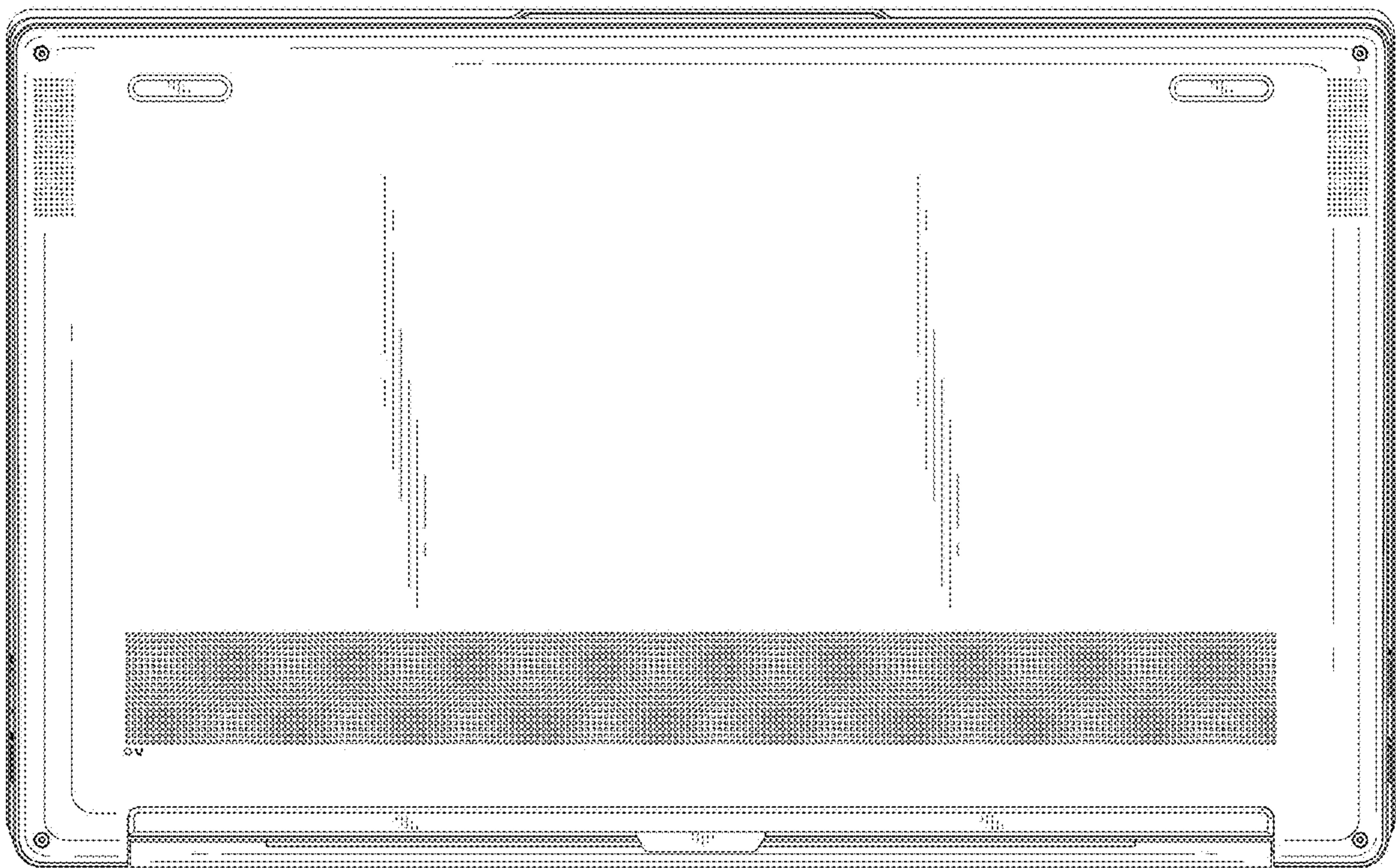

3.1

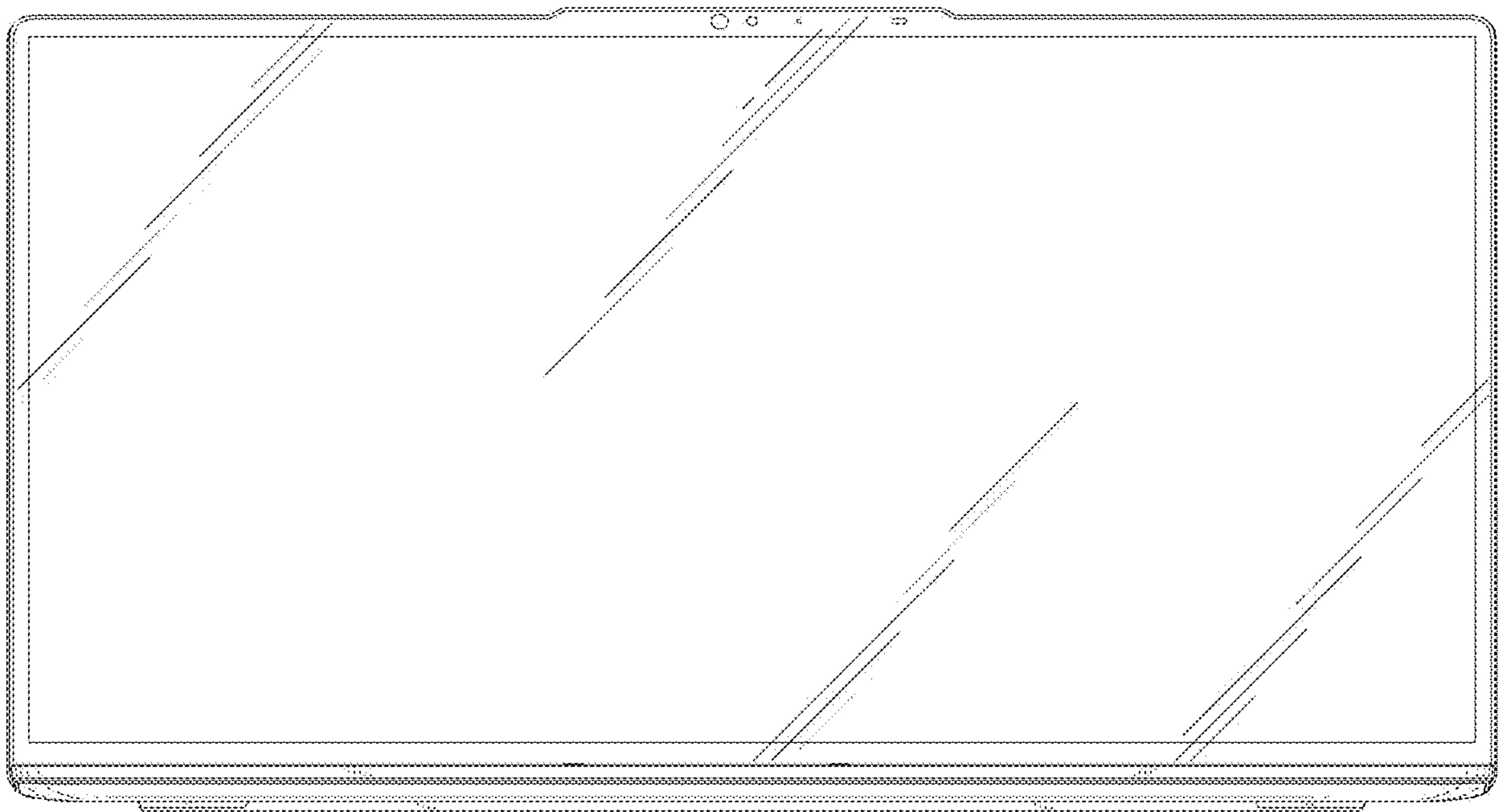

3.2

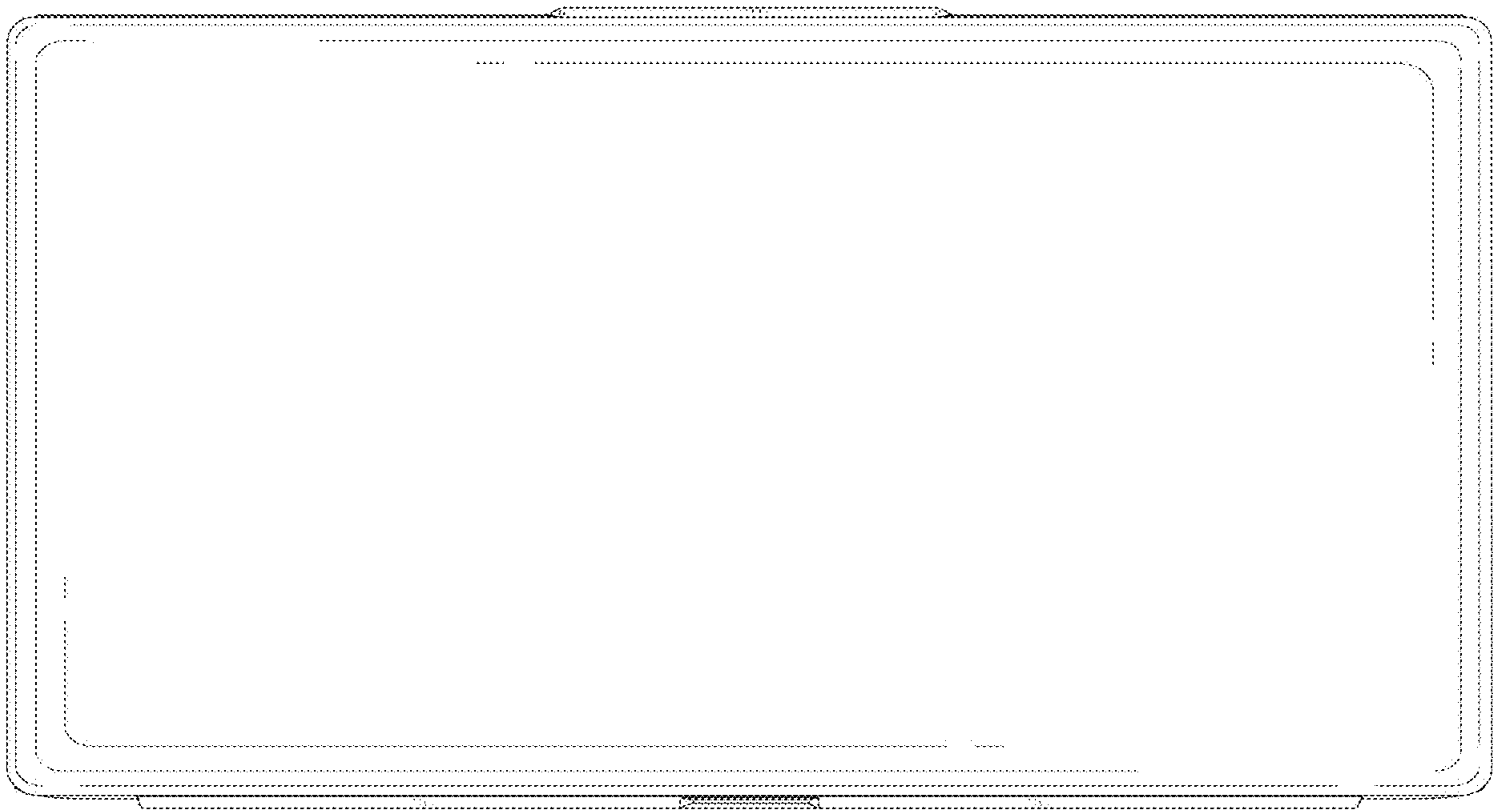

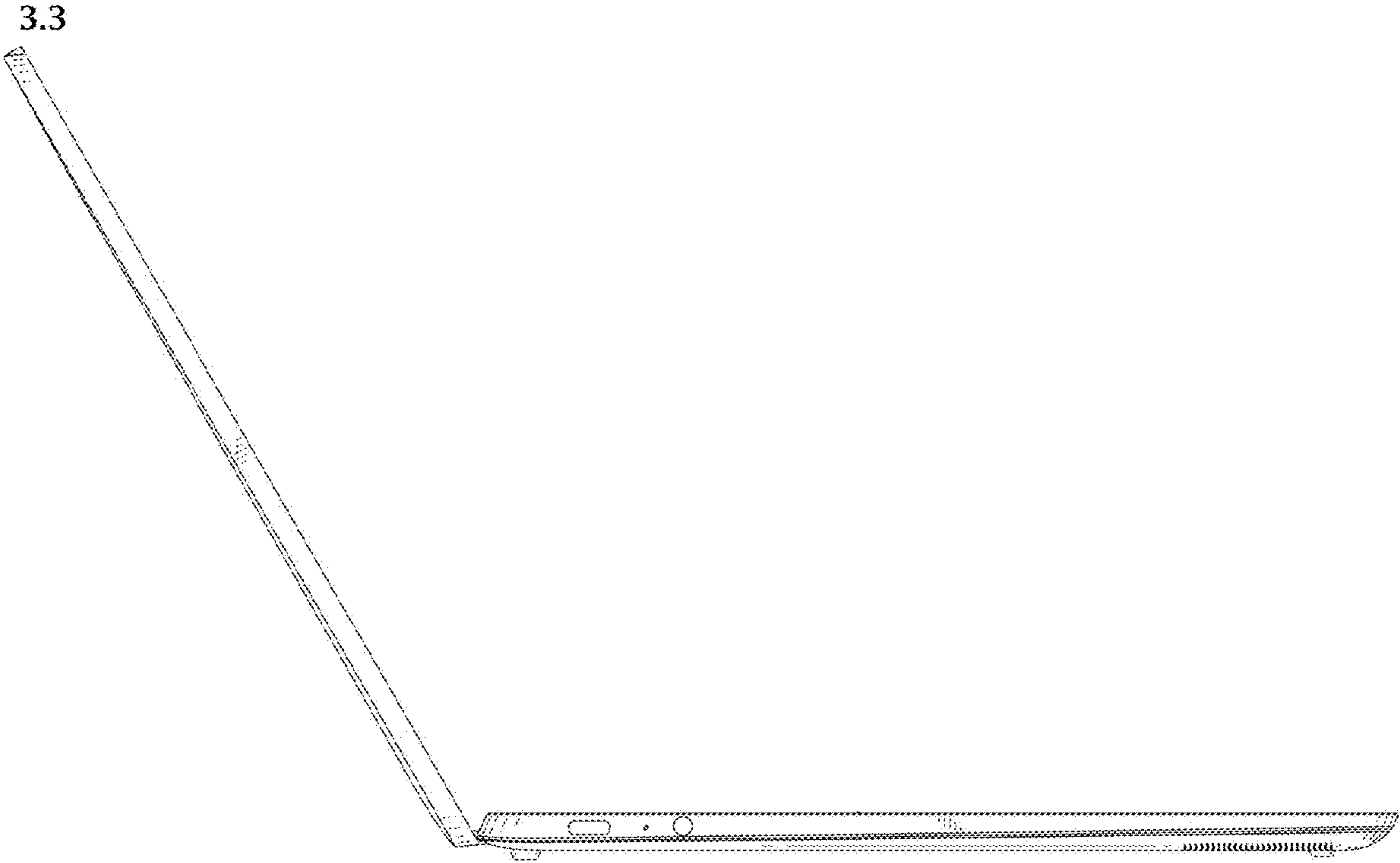

3.4

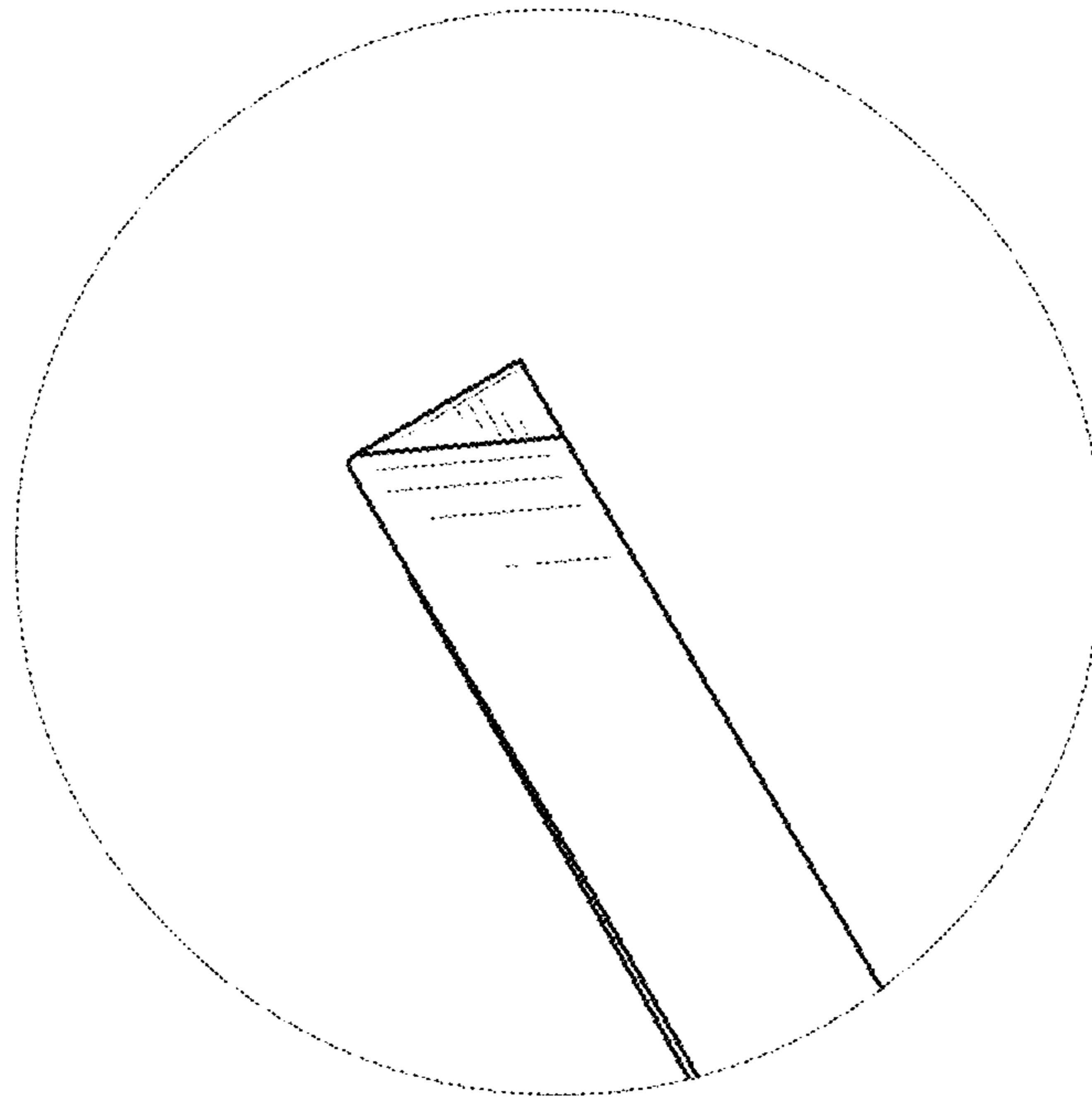

3.5

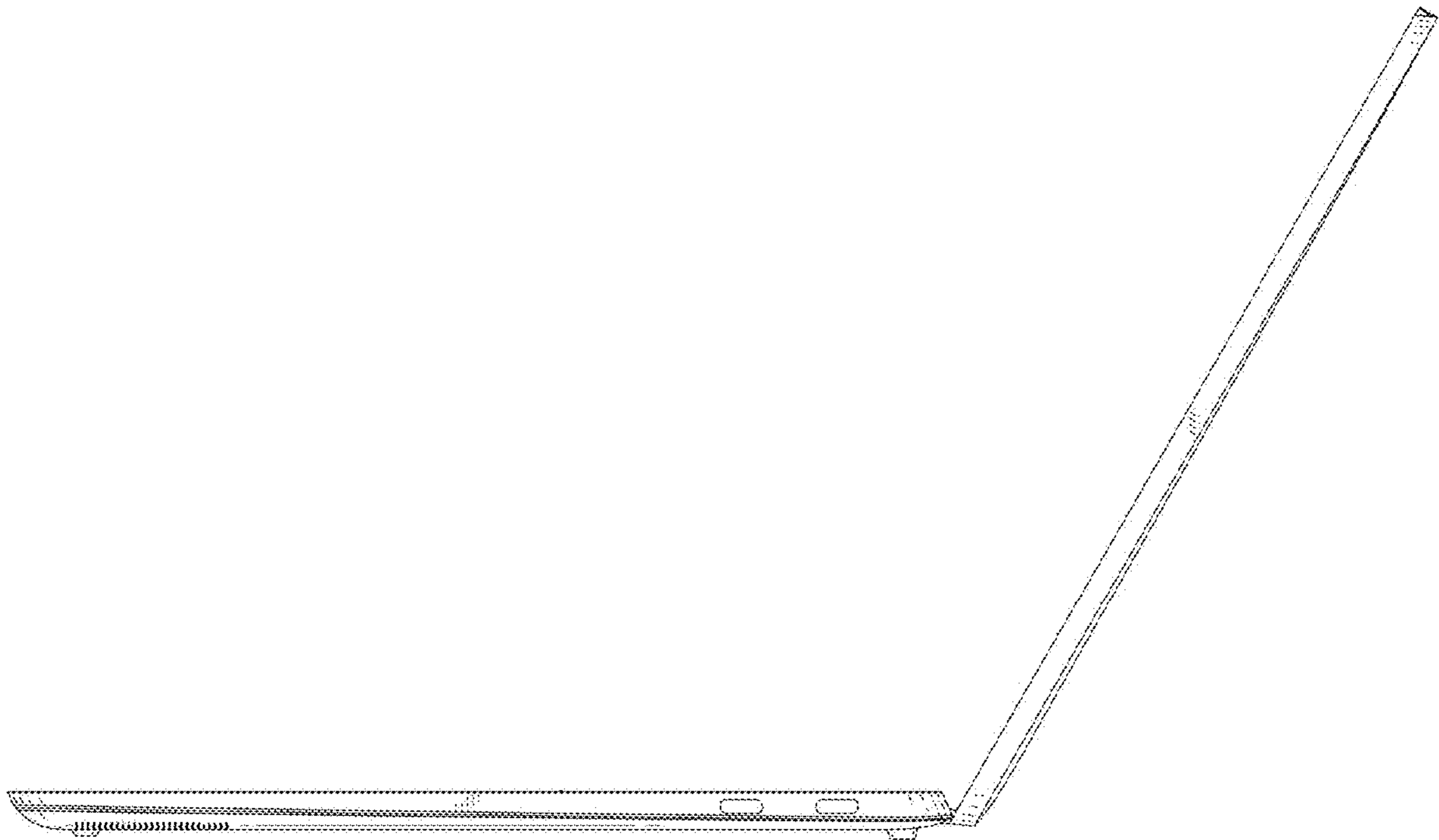

3.6

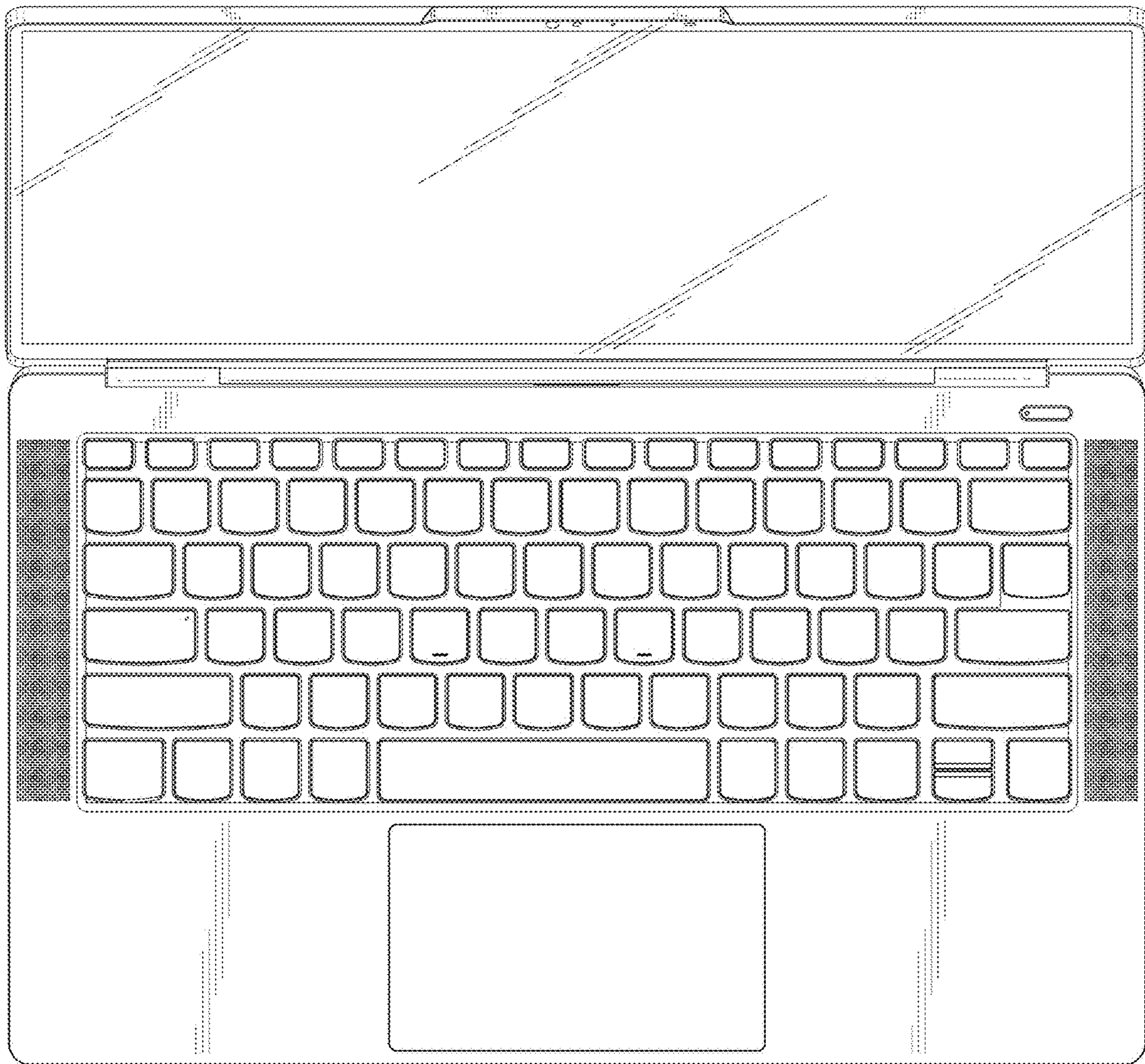

3.7

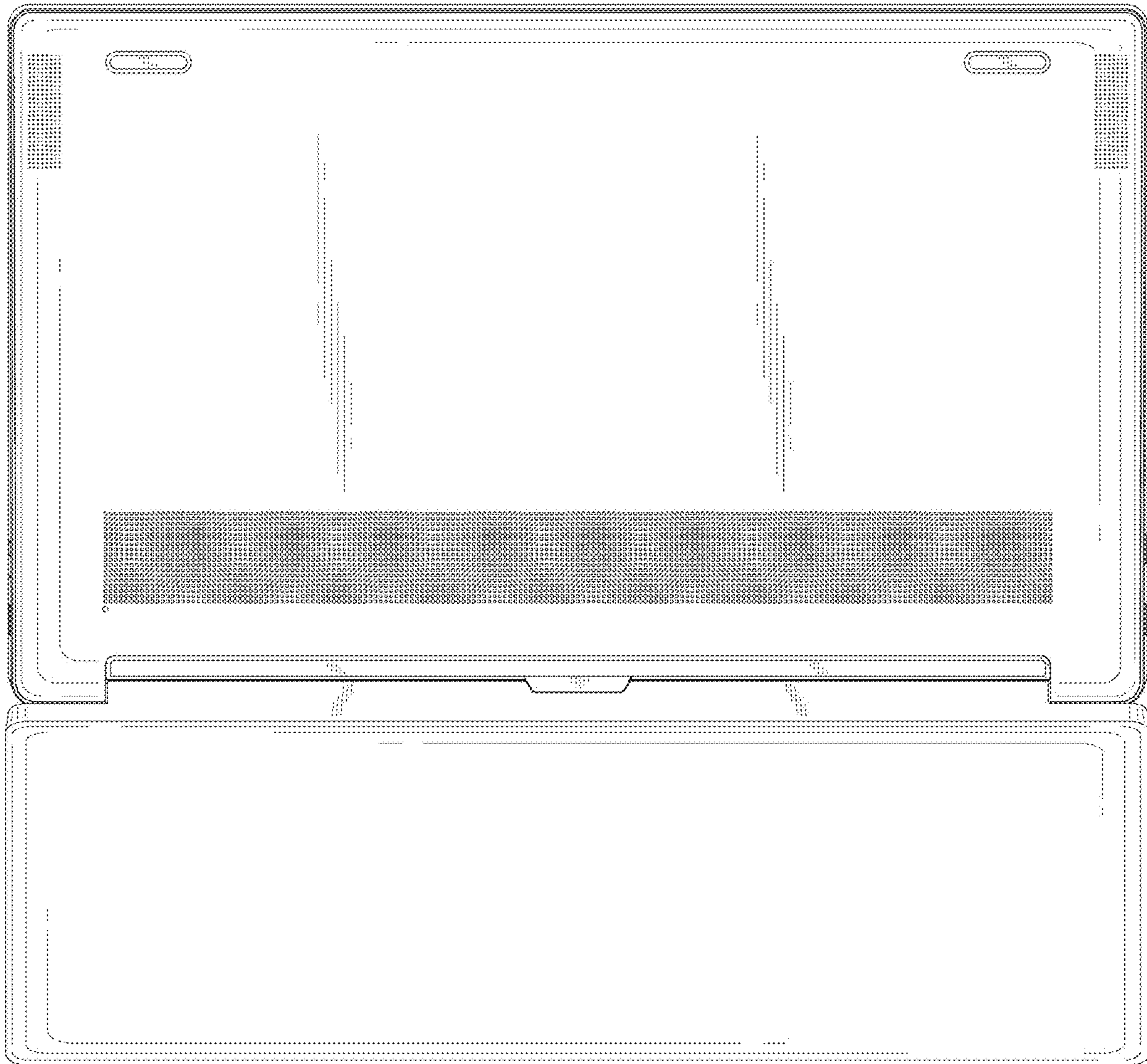

3.8

