



US00D914603S

(12) **United States Design Patent**
Wang

(10) **Patent No.:** **US D914,603 S**

(45) **Date of Patent:** **** Mar. 30, 2021**

(54) **PROTECTIVE COVER FOR EARPHONE CHARGING CASE**

(71) Applicant: **SHENZHEN JU NETWORK TECHNOLOGY CO., LTD**, Shenzhen (CN)

(72) Inventor: **Kai Wang**, Shenzhen (CN)

(73) Assignee: **SHENZHEN JU NETWORK TECHNOLOGY CO., LTD**, Shenzhen (CN)

(**) Term: **15 Years**

(21) Appl. No.: **29/743,305**

(22) Filed: **Jul. 21, 2020**

(51) **LOC (13) Cl.** **13-02**

(52) **U.S. Cl.**
USPC **D13/118; D3/321**

(58) **Field of Classification Search**
USPC D13/103, 107–110, 118–119, 184, 199; D3/201, 218, 318, 321, 328, 269, 273, D3/294, 274, 300; D14/217, 223, 238.1, D14/440

CPC .. H02J 50/00; H02J 50/10; H02J 50/12; H02J 50/80; H02J 7/025; H02J 7/005; H02J 7/0026; H02J 7/0044; H02J 7/0045; H02J 7/0013; H02J 7/0003; A45C 2011/001; A45C 2011/002; A45C 2011/003

See application file for complete search history.

(56) **References Cited**

U.S. PATENT DOCUMENTS

| | | | | |
|--------------|--------|----------|-------|---------|
| D822,386 S * | 7/2018 | Tsai | | D3/321 |
| D874,823 S * | 2/2020 | Christen | | D3/294 |
| D882,259 S * | 4/2020 | Liu | | D3/269 |
| D886,445 S * | 6/2020 | Hyun | | D3/201 |
| D887,140 S * | 6/2020 | Hyun | | D3/302 |
| D888,663 S * | 6/2020 | Weng | | D13/108 |
| D895,287 S * | 9/2020 | Hyun | | D3/302 |

| | | | | |
|--------------|---------|------|-------|---------|
| D895,288 S * | 9/2020 | Hyun | | D3/302 |
| D901,177 S * | 11/2020 | Wei | | D3/294 |
| D902,854 S * | 11/2020 | Feng | | D13/108 |
| D904,005 S * | 12/2020 | Jung | | D3/201 |
| D904,765 S * | 12/2020 | Hyun | | D3/302 |
| D905,066 S * | 12/2020 | Lee | | D14/440 |
| D905,430 S * | 12/2020 | Kwak | | D3/273 |
| D906,342 S * | 12/2020 | Lee | | D14/440 |
| D907,048 S * | 1/2021 | Wang | | D14/440 |

(Continued)

OTHER PUBLICATIONS

“Mastten Headphone Cases Compatible with AirPods Pro Case Cover, Flexible Hard Shield Design”, first available on Oct. 20, 2020. <https://www.amazon.com/Mastten-Headphone-Compatible-Protective-Carabiner/dp/B08LFYXCXZ/ref=sr_1_36?dchild=1&keywords=airpods+case+cover&qid=1610759121&sr=8-36> (Year: 2020).*

(Continued)

Primary Examiner — Rosemary K Tarcza

(57) **CLAIM**

The ornamental design for a protective cover for earphone charging case, as shown and described.

DESCRIPTION

FIG. 1 is a perspective view of a protective cover for earphone charging case showing my new design; FIG. 2 is another perspective view thereof; FIG. 3 is a front elevational view thereof; FIG. 4 is a rear elevational view thereof; FIG. 5 is a left side elevational view thereof; FIG. 6 is a right side elevational view thereof; FIG. 7 is a top plan view thereof; and, FIG. 8 is a bottom plan view thereof. The broken lines in the drawings depict portions of the protective cover for earphone charging case that form no part of the claimed design.

1 Claim, 8 Drawing Sheets

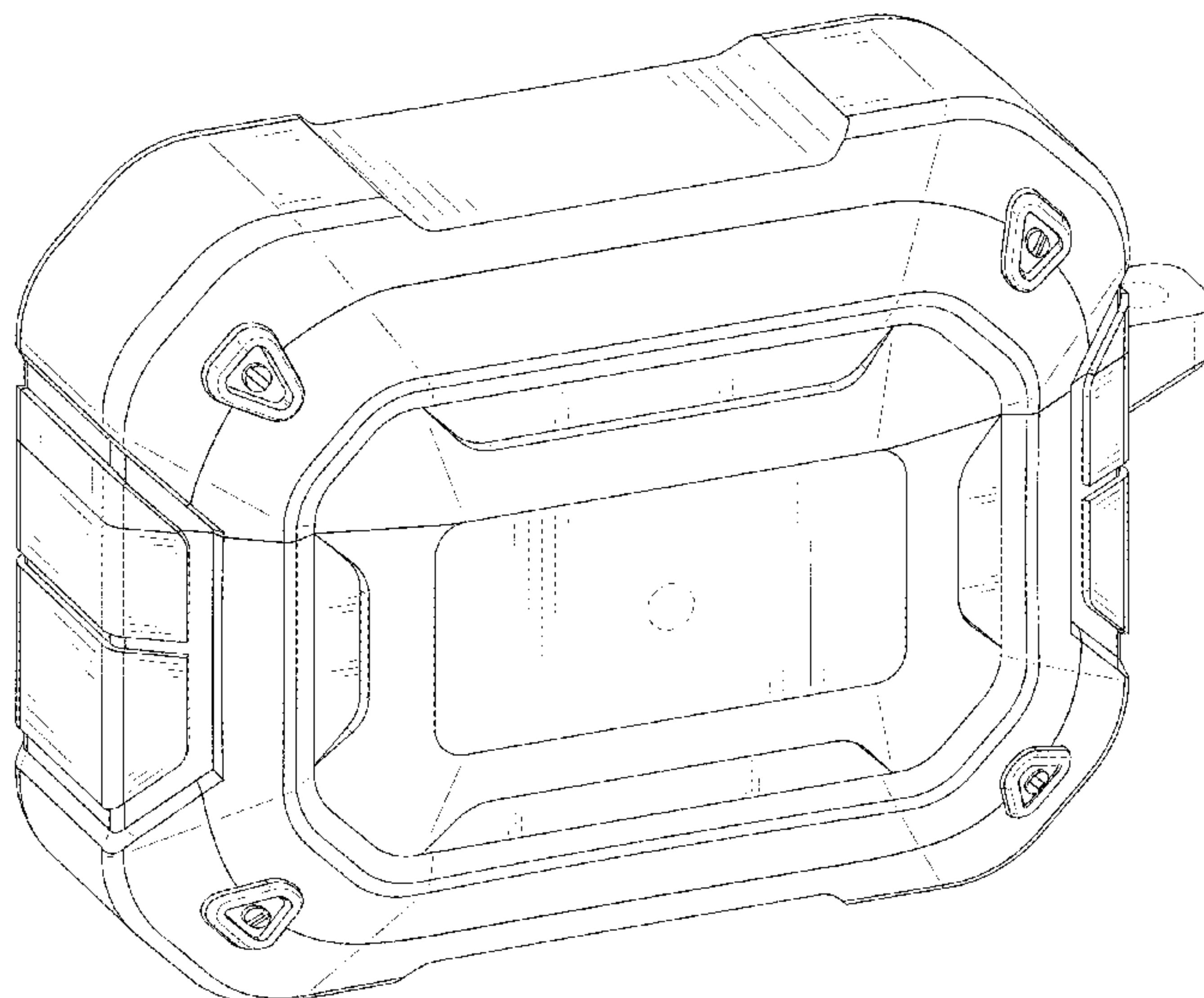

(56)

References Cited

U.S. PATENT DOCUMENTS

D907,049 S * 1/2021 Yu D14/440

OTHER PUBLICATIONS

“Headphones AirPods Case Bluetooth. Wireless Headset AirPods Hard Protective Travel Carrying Case for Earbuds Earphone Keep Headsets Away from Damaged”, Retrieved Jul. 21, 2020]. Retrieved from Internet, <https://www.amazon.com/Headphones-Bluetooth-Wireless-Protective-Carrying/dp/B071D2PKD3/ref>.

“ProCase AirPods Pro Case Jabra Elite 75t Earbuds Case, Hard EVA Shockproof Travel Carrying Case for Apple AirPods Pro Charging Case 2019 /Jabra Elite 75t—Black”, Retrieved Jul. 21, 2020]. Retrieved from Internet, <https://www.amazon.com/ProCase-AirPods-Shockproof-Carrying-Charging/dp/B082WR2S6H/ref>.

* cited by examiner

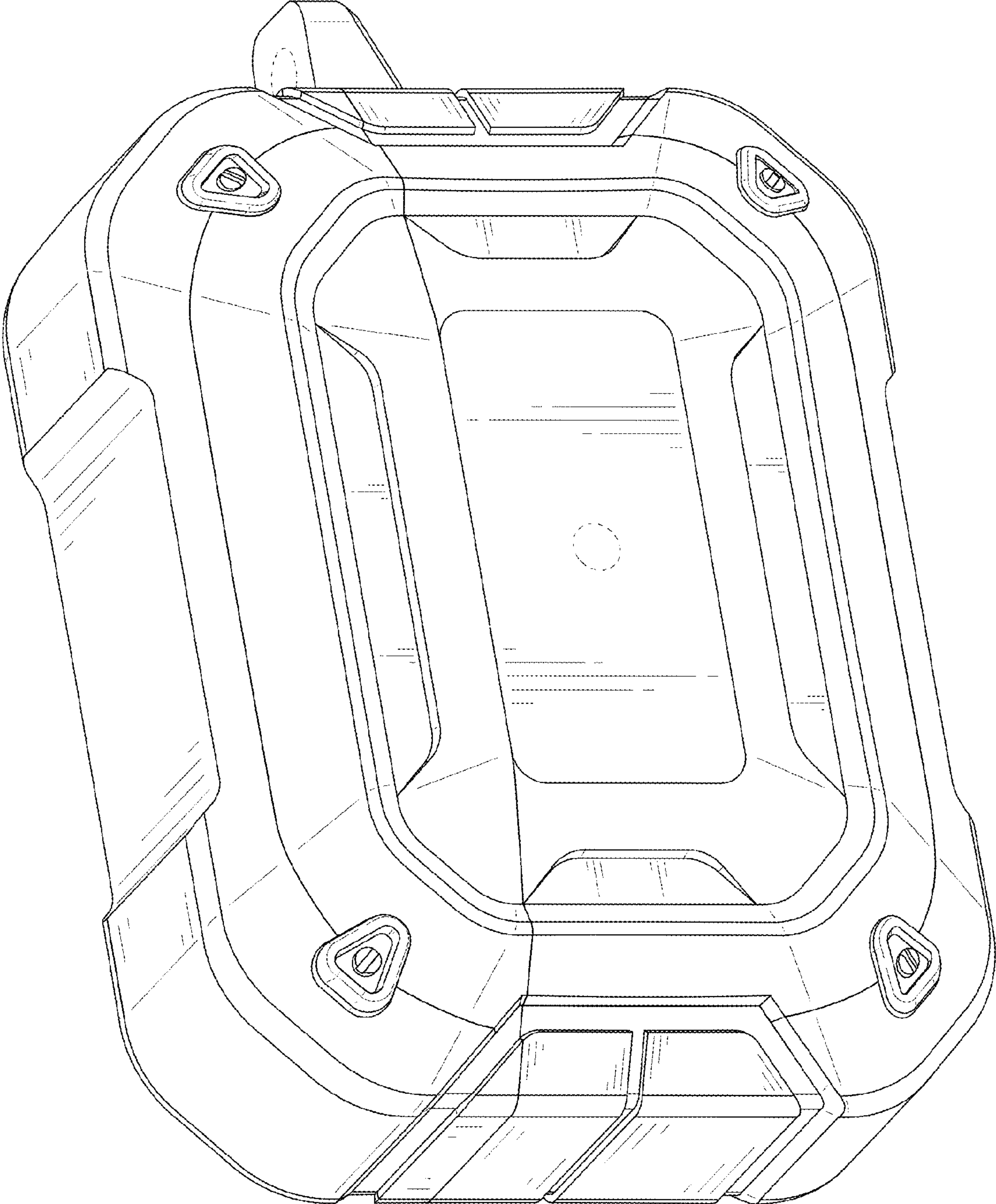

FIG. 1

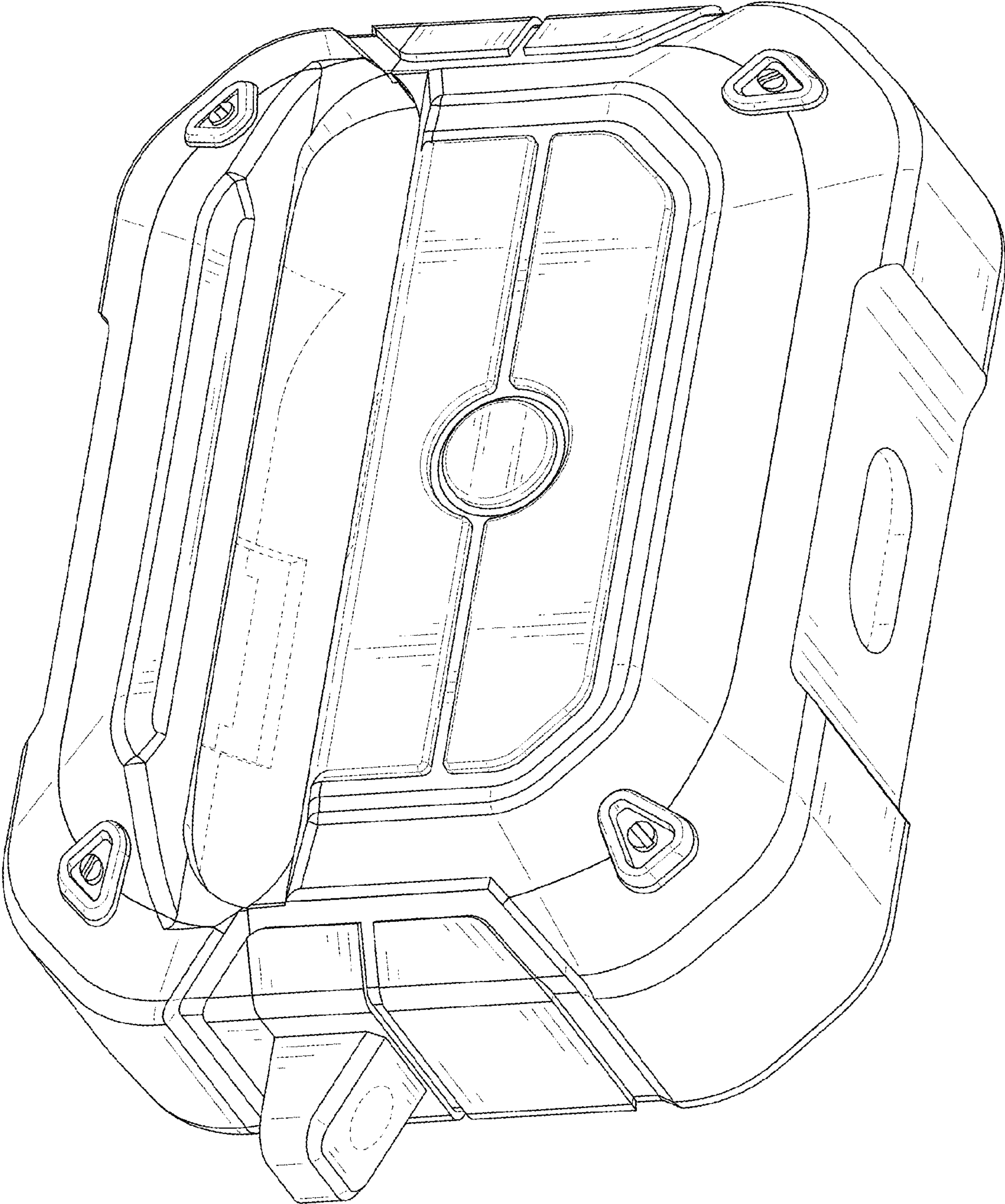

FIG. 2

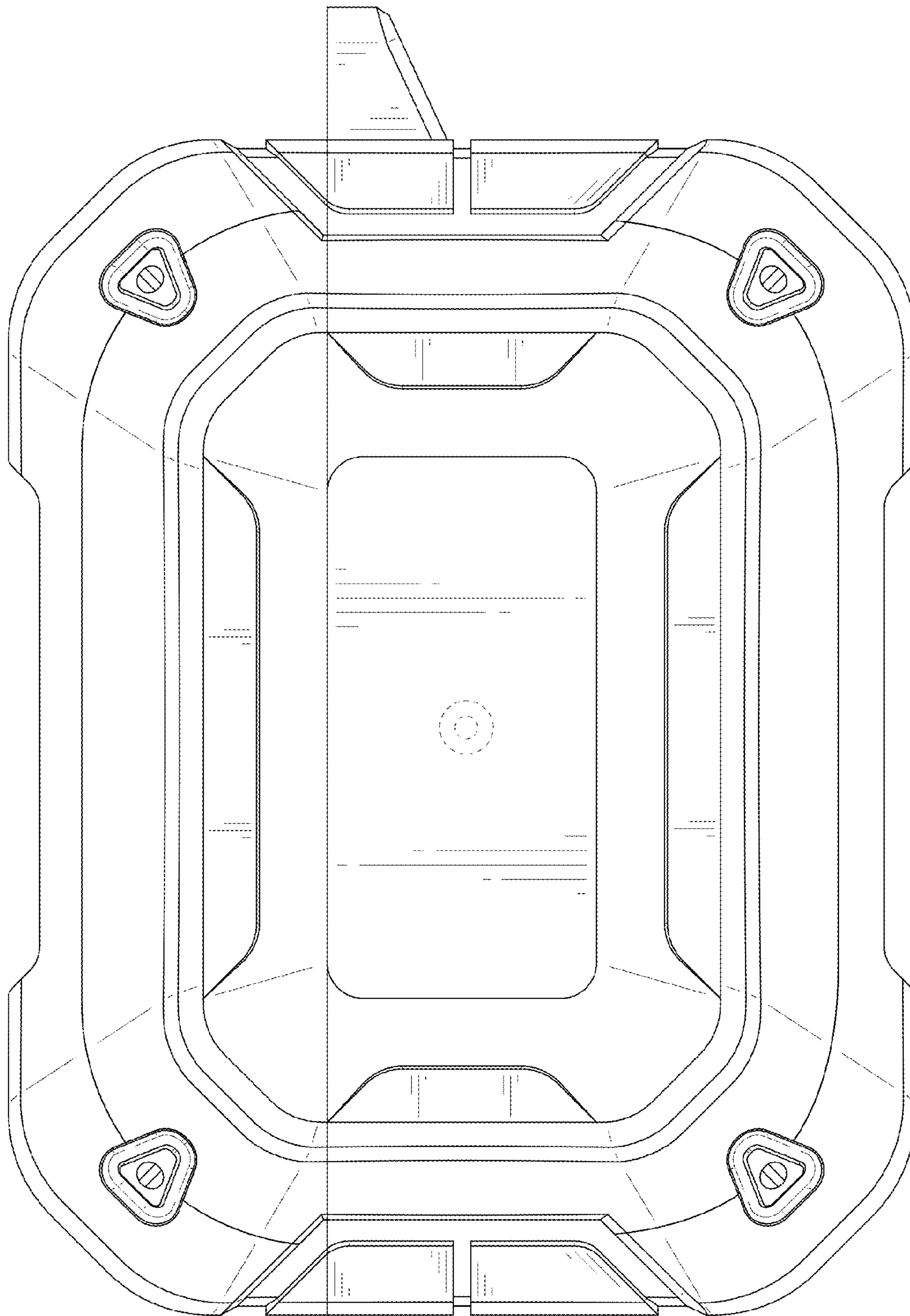

FIG. 3

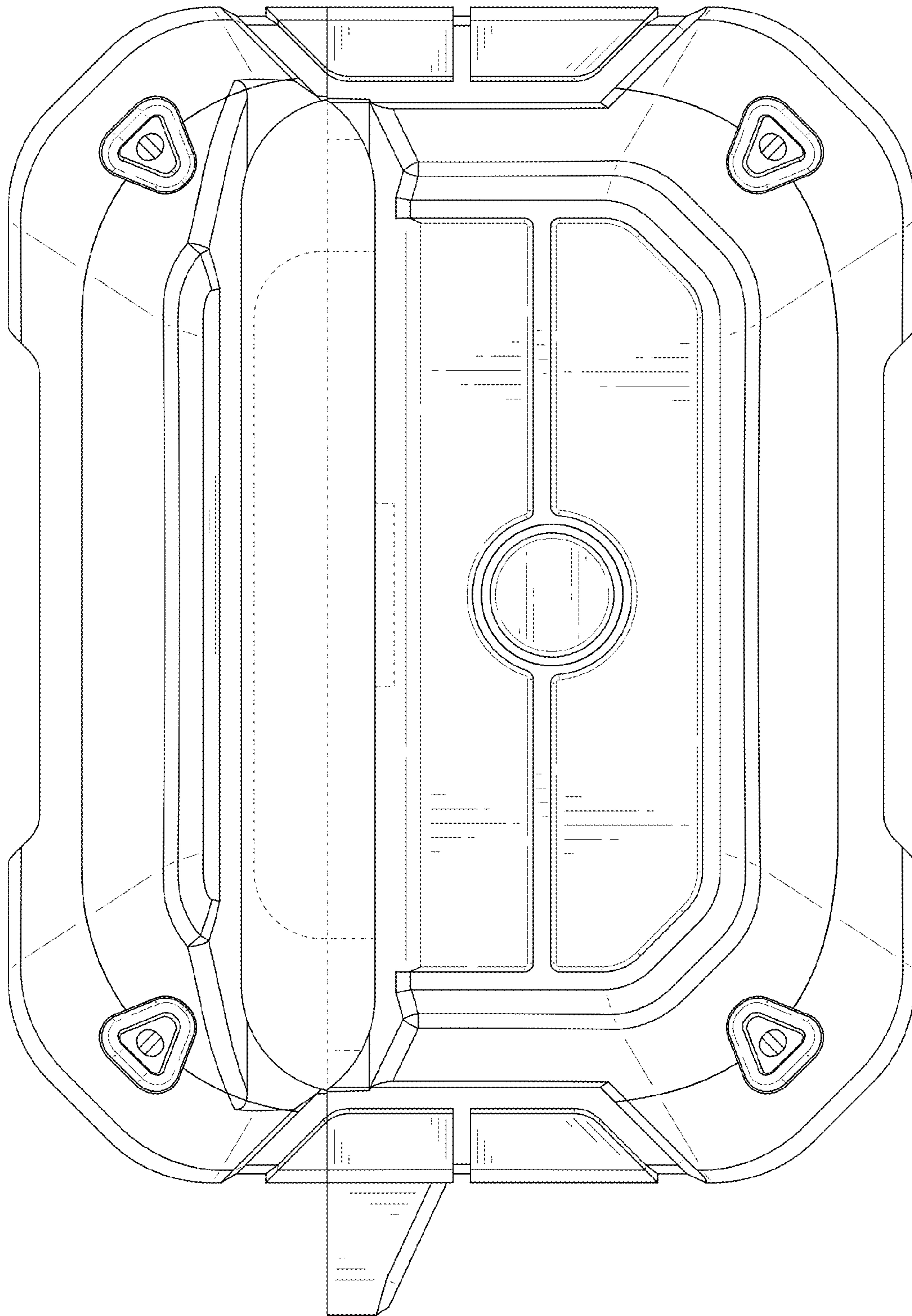

FIG. 4

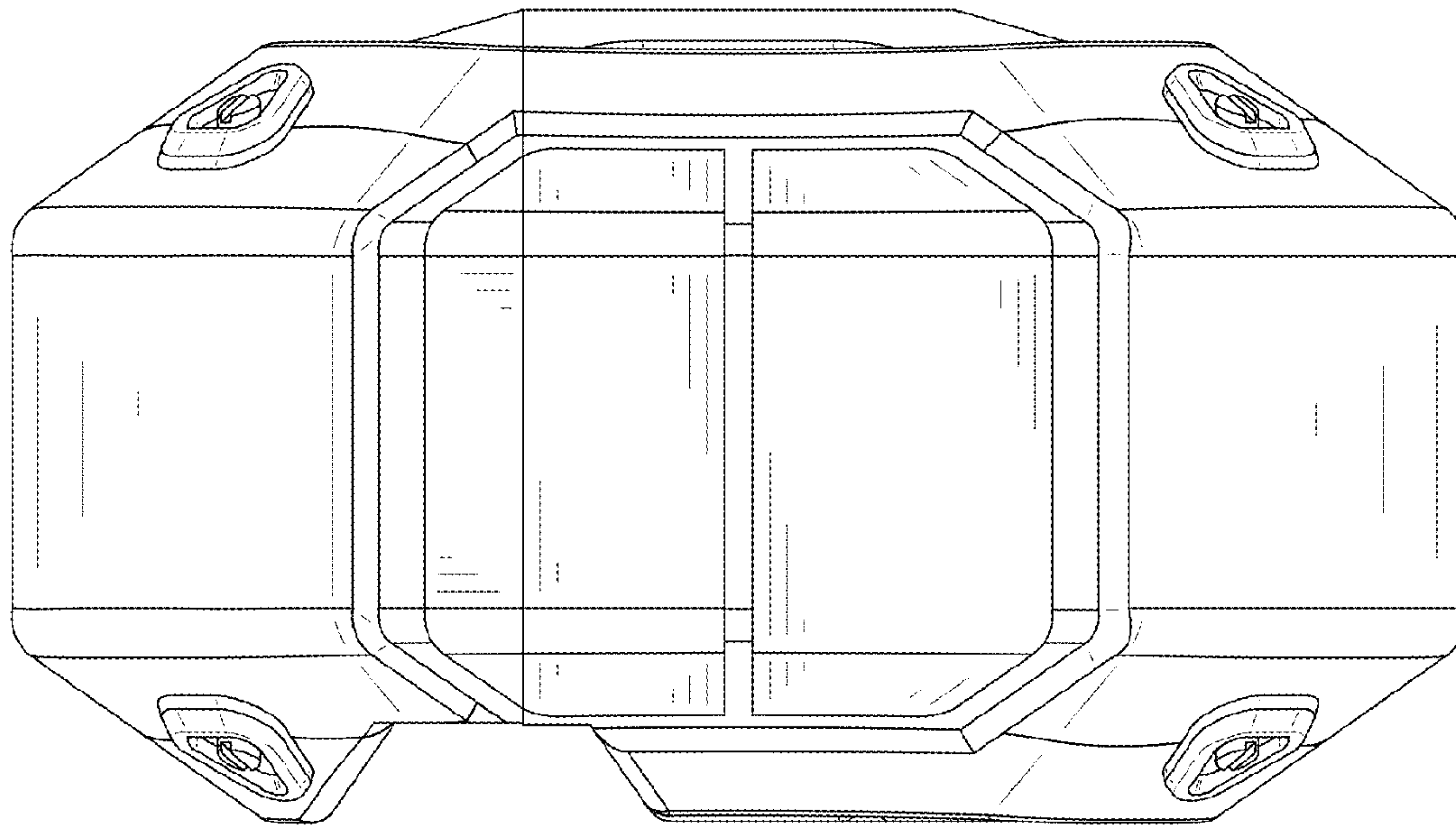

FIG. 5

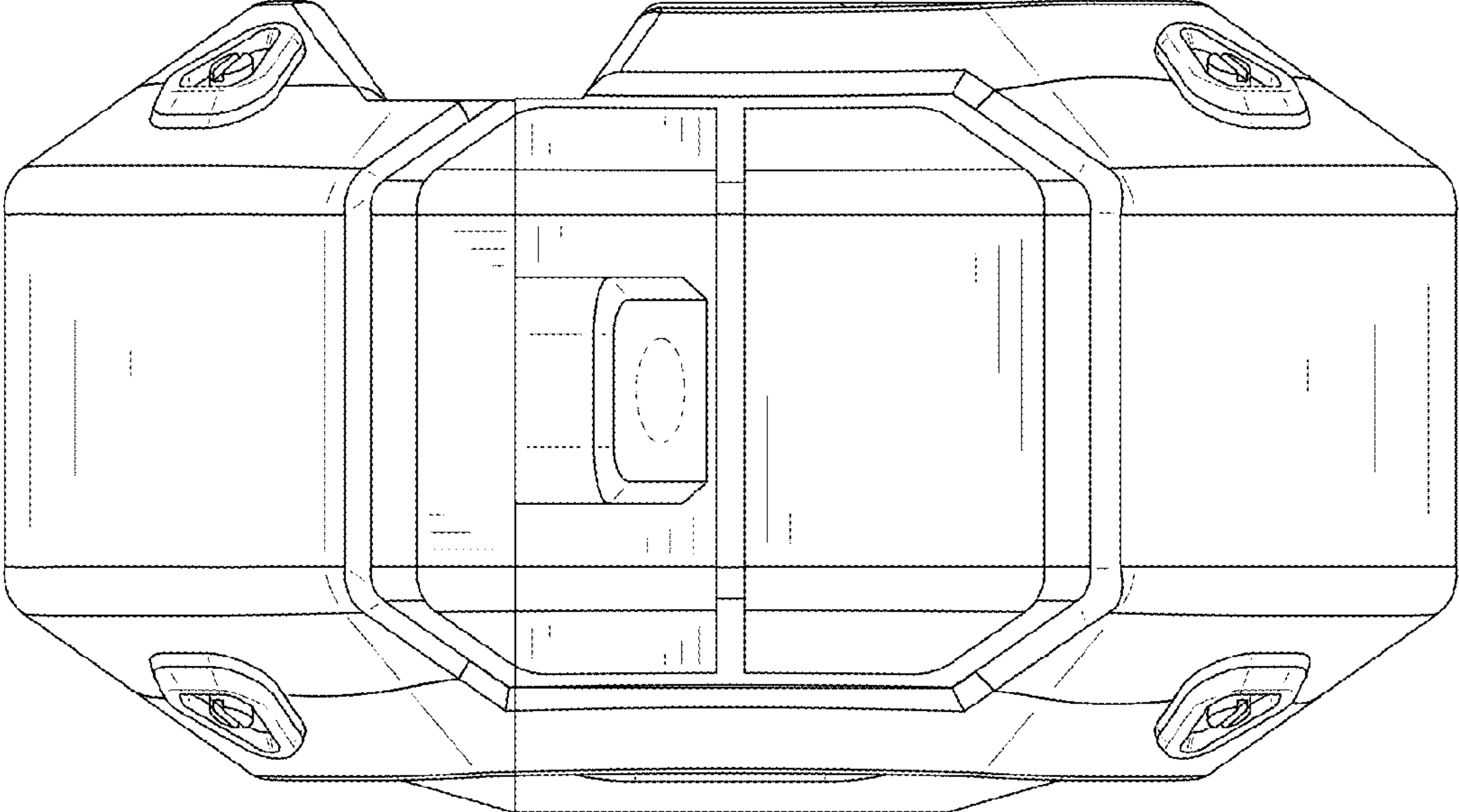

FIG. 6

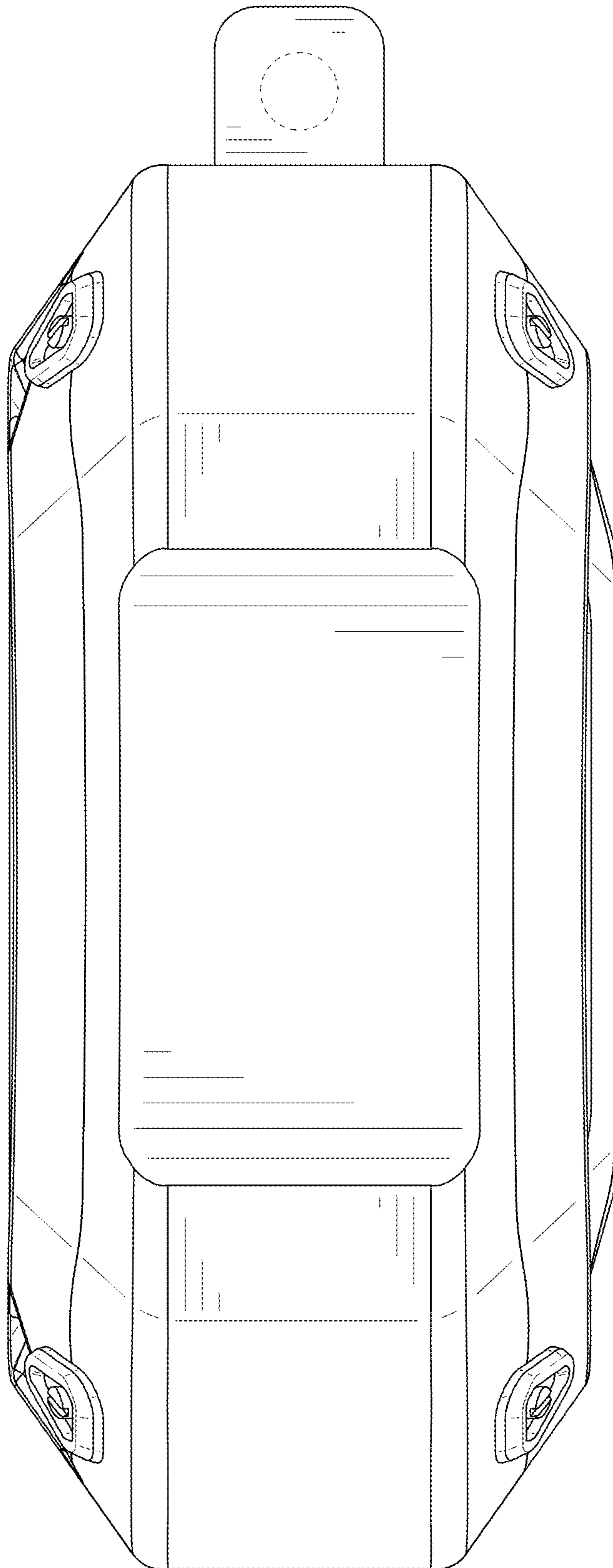

FIG. 7

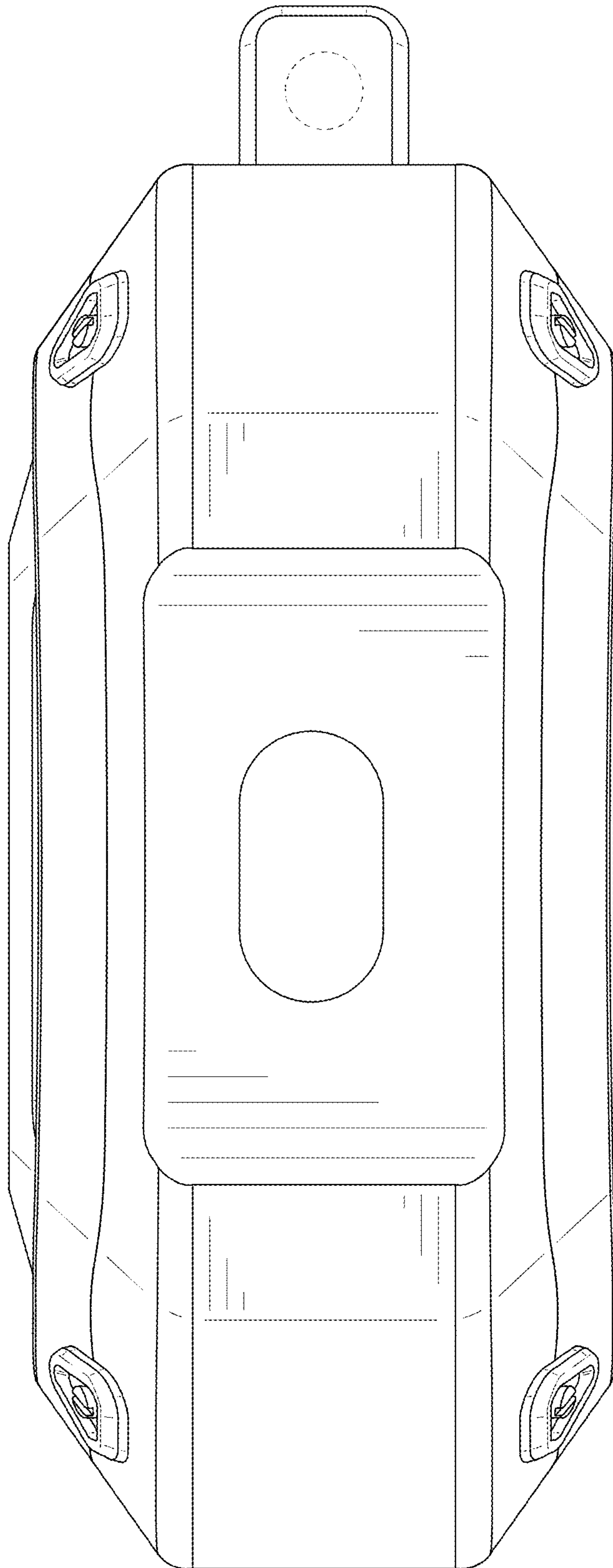

FIG. 8