



US00D914529S

(12) **United States Design Patent** (10) **Patent No.:** **US D914,529 S**
Green et al. (45) **Date of Patent:** **** Mar. 30, 2021**

(54) **INTERCHANGEABLE JEWELRY KEY**

3,905,525 A 9/1975 Kawamata
4,959,890 A 10/1990 Pazurek
5,048,311 A 9/1991 Mastrobuono
D326,827 S * 6/1992 Peterson D11/40
5,357,659 A 10/1994 Ackermann
D363,042 S * 10/1995 Papernik D11/86
5,505,061 A 4/1996 Fleury et al.

(71) Applicant: **Style Dots LLC**, Rockford, MI (US)

(72) Inventors: **Karen L. Green**, West Sacramento, CA (US); **Gina M. Smith**, Nixa, MO (US)

(73) Assignee: **STYLE DOTS LLC**, Rockford, MI (US)

(Continued)

(**) Term: **15 Years**

FOREIGN PATENT DOCUMENTS

WO 03/79841 A1 10/2003

(21) Appl. No.: **29/675,501**

OTHER PUBLICATIONS

(22) Filed: **Jan. 2, 2019**

Office Action received for Canadian Patent Application No. 2998583, dated Nov. 12, 2020, 4 pages.

(Continued)

Related U.S. Application Data

(63) Continuation of application No. 15/745,676, filed on Jan. 17, 2018, which is a continuation of application No. 15/932,446, filed on Dec. 6, 2016, now abandoned.

Primary Examiner — Llorellys Martinez

(74) *Attorney, Agent, or Firm* — Workman Nydegger

(51) **LOC (13) Cl.** **11-01**

(57) **CLAIM**

(52) **U.S. Cl.**
USPC **D11/2; D8/347**

The ornamental design for an interchangeable jewelry key, as shown and described.

(58) **Field of Classification Search**
USPC D11/1-3, 40, 43, 79, 86; D3/207, 208;
D8/347

DESCRIPTION

CPC . A44C 17/0225; A44C 17/0208; A44C 17/02;
A44C 17/0216; A44C 25/001; A44C
11/00; A44C 11/002

FIG. 1 is a top, left perspective view of an interchangeable jewelry key;

FIG. 2 is a right elevation view thereof;

FIG. 3 is a left elevation view thereof;

FIG. 4 is a bottom elevation view thereof;

FIG. 5 is a top elevational view thereof;

FIG. 6 is a front elevational view thereof; and,

FIG. 7 is a rear elevational view thereof.

See application file for complete search history.

The broken lines in the drawings represent portions of the interchangeable jewelry key that form no part of the claimed design. The other broken lines showing text indicia represent environmental subject matter only and form no part of the claimed design.

(56) **References Cited**

U.S. PATENT DOCUMENTS

697,120 A 4/1902 Wade
901,333 A 10/1908 Fitzgerald
1,052,141 A 2/1913 Gaschke
1,448,465 A 3/1923 Sherman
D123,719 S 11/1940 Ungar
D174,242 S 3/1955 Warwick et al.
3,831,398 A 8/1974 Davis

1 Claim, 3 Drawing Sheets

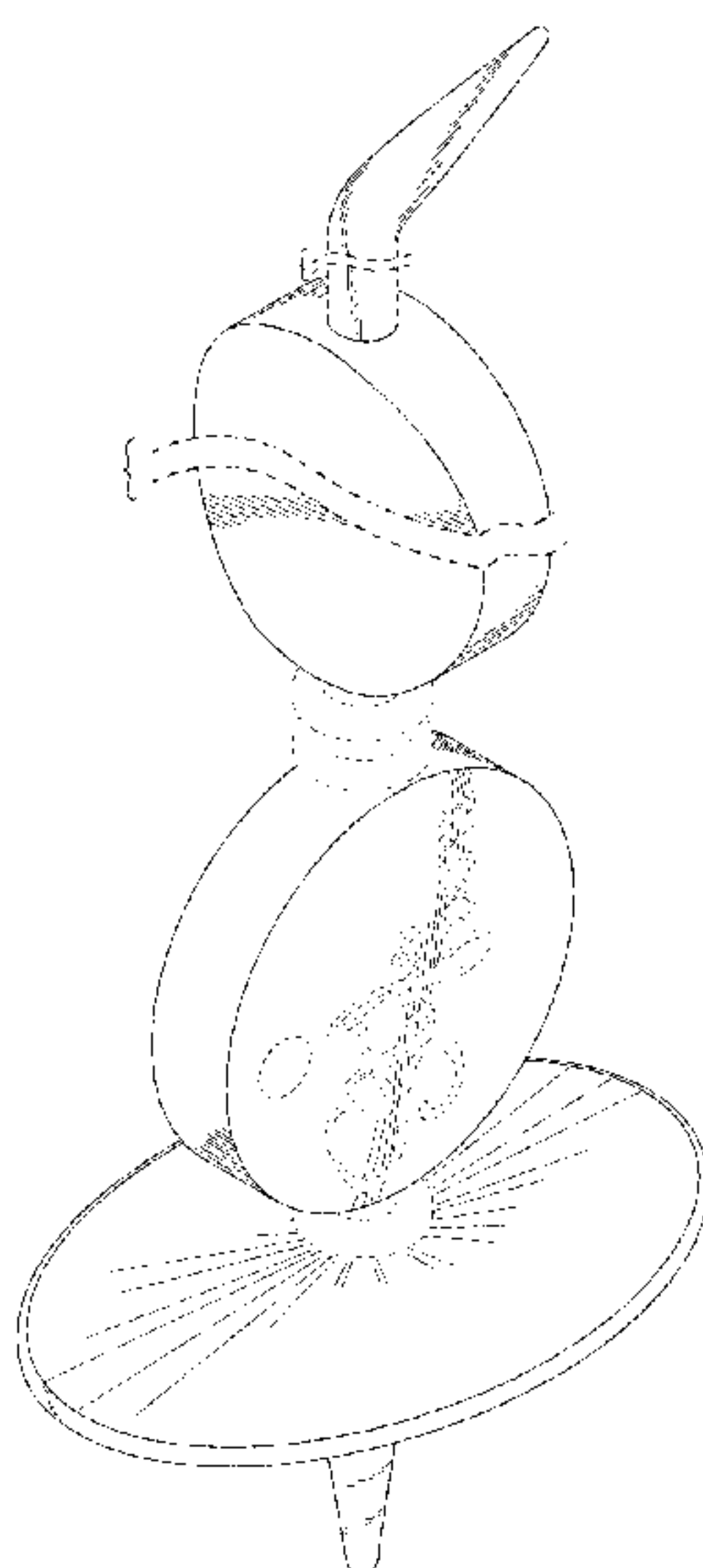

(56)

References Cited

U.S. PATENT DOCUMENTS

5,709,327 A * 1/1998 LaMacchia A44C 5/00
223/111

5,794,459 A 8/1998 Ignatowski

6,544,164 B1 4/2003 Fan

D511,473 S 11/2005 Weinacht

D539,698 S 4/2007 Choi

D551,585 S 9/2007 Wooley et al.

7,980,095 B1 * 7/2011 Masterson A44C 11/002
63/41

D657,281 S 4/2012 Psaute

8,429,934 B2 * 4/2013 Roessler A44C 9/0084
63/15

8,650,723 B2 2/2014 Reiter

D713,755 S * 9/2014 Thompson D11/43

D714,181 S * 9/2014 Thompson D11/43

D723,409 S * 3/2015 Theodore D11/3

D728,417 S 5/2015 Pferdehirt

D728,419 S 5/2015 Pferdehirt

D742,787 S 11/2015 Schoenbeck et al.

D794,556 S * 8/2017 Liao D3/208

D803,716 S 11/2017 Grainger

D810,608 S * 2/2018 Heller D11/79

D810,609 S * 2/2018 Heller D11/79

D835,809 S 12/2018 Marshall

D838,208 S 1/2019 Hirabayashi et al.

D861,535 S 10/2019 Venables

D867,920 S 11/2019 O'Connell

D872,606 S * 1/2020 Green D11/1

D878,238 S 3/2020 Holmes et al.

D886,658 S 6/2020 Duncan et al.

2001/0031443 A1 10/2001 Ferranti

2002/0073732 A1 6/2002 Masina et al.

2004/0200236 A1 10/2004 Emberson et al.

2005/0148809 A1 7/2005 Delaney

2005/0166634 A1 8/2005 Lieberman

2006/0144083 A1 7/2006 Layton

2011/0088428 A1 * 4/2011 Urban A44C 11/00
63/23

2012/0131953 A1 5/2012 Fahsel

2012/0240623 A1 9/2012 Morse

2012/0324946 A1 * 12/2012 Latouf A44C 13/00
63/1.13

2013/0160489 A1 6/2013 Arjang et al.

2013/0263625 A1 10/2013 Taylor-Cattapan

2015/0020543 A1 1/2015 Kaupp

2015/0359301 A1 12/2015 Lavorato et al.

2017/0317705 A1 * 11/2017 Duneier A44C 15/0015

2019/0098970 A1 * 4/2019 Stein A44C 25/001

2020/0100571 A1 4/2020 Green et al.

2020/0121042 A1 4/2020 Green et al.

OTHER PUBLICATIONS

Final Office Action received for U.S. Appl. No. 15/745,676, dated Aug. 14, 2020, 6 pages.

Final Office Action received for U.S. Appl. No. 16/723,906, dated Jul. 7, 2020, 9 pages.

International Search Report and Written Opinion for application No. PCT/US2017/064945 dated Mar. 16, 2018.

Non-Final Office Action for U.S. Appl. No. 16/723,906 dated, Feb. 19, 2020.

Office Action for Canadian Application No. 2,998,583 dated, Jan. 15, 2020.

Office Action received for Chinese Patent Application No. 201790001596.4, dated Jun. 16, 2020, 2 pages.

U.S. Appl. No. 15/932,446, filed Dec. 6, 2016, Green et al.

Notice of Allowance received for U.S. Appl. No. 16/723,906, dated Oct. 19, 2020, 5 pages.

Examiner Interview Summary received for U.S. Appl. No. 15/745,676, dated Dec. 4, 2020, 3 pages.

Non-Final Rejection for U.S. Appl. No. 15/745,676, dated Jan. 4, 2021.

* cited by examiner



FIG. 1

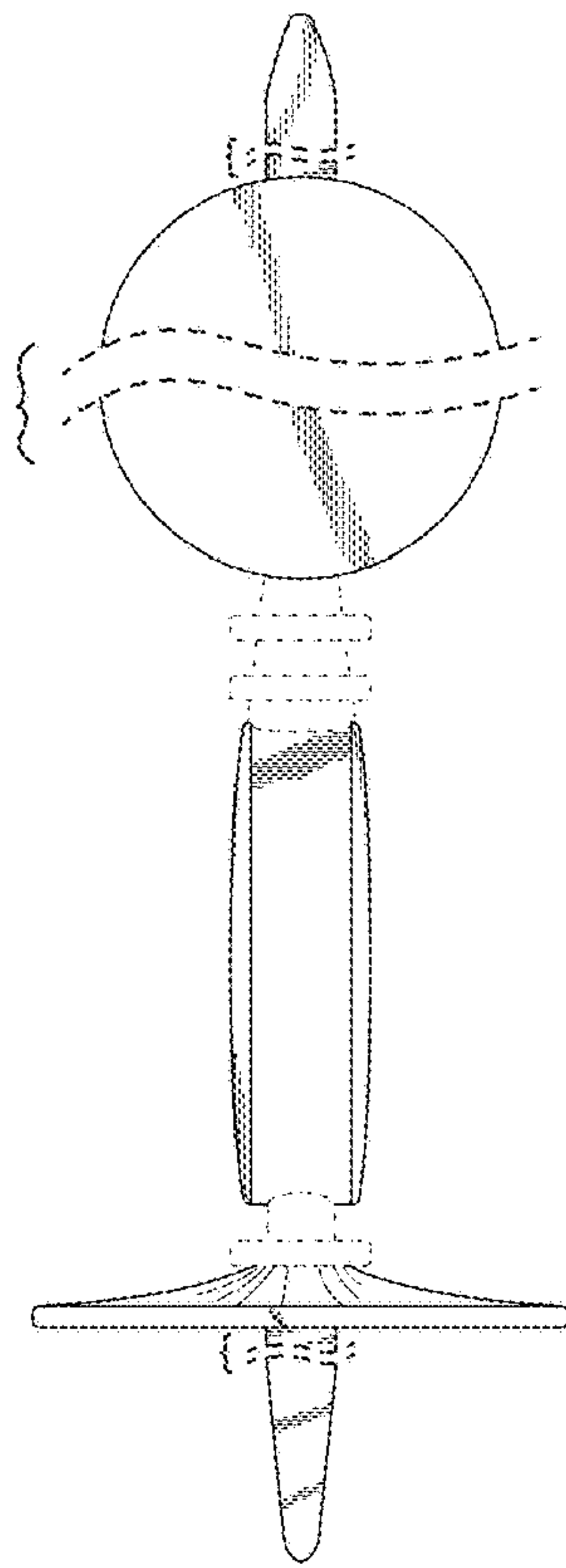

FIG. 2

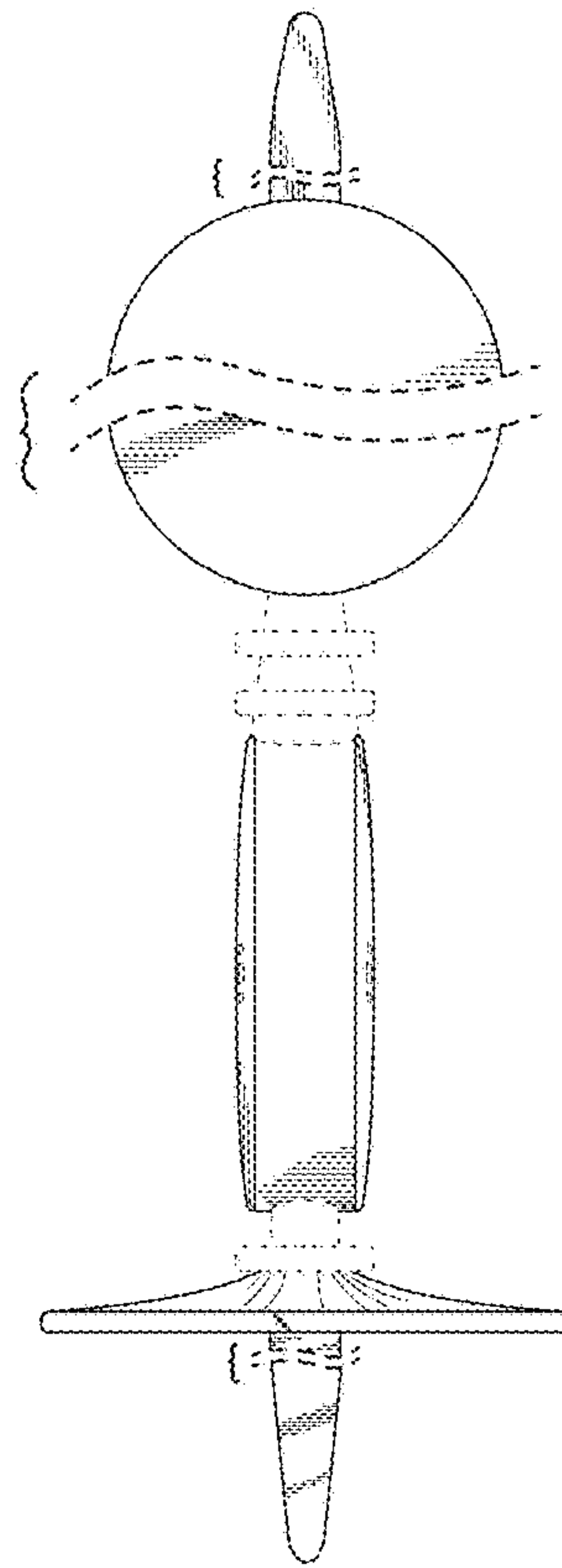

FIG. 3

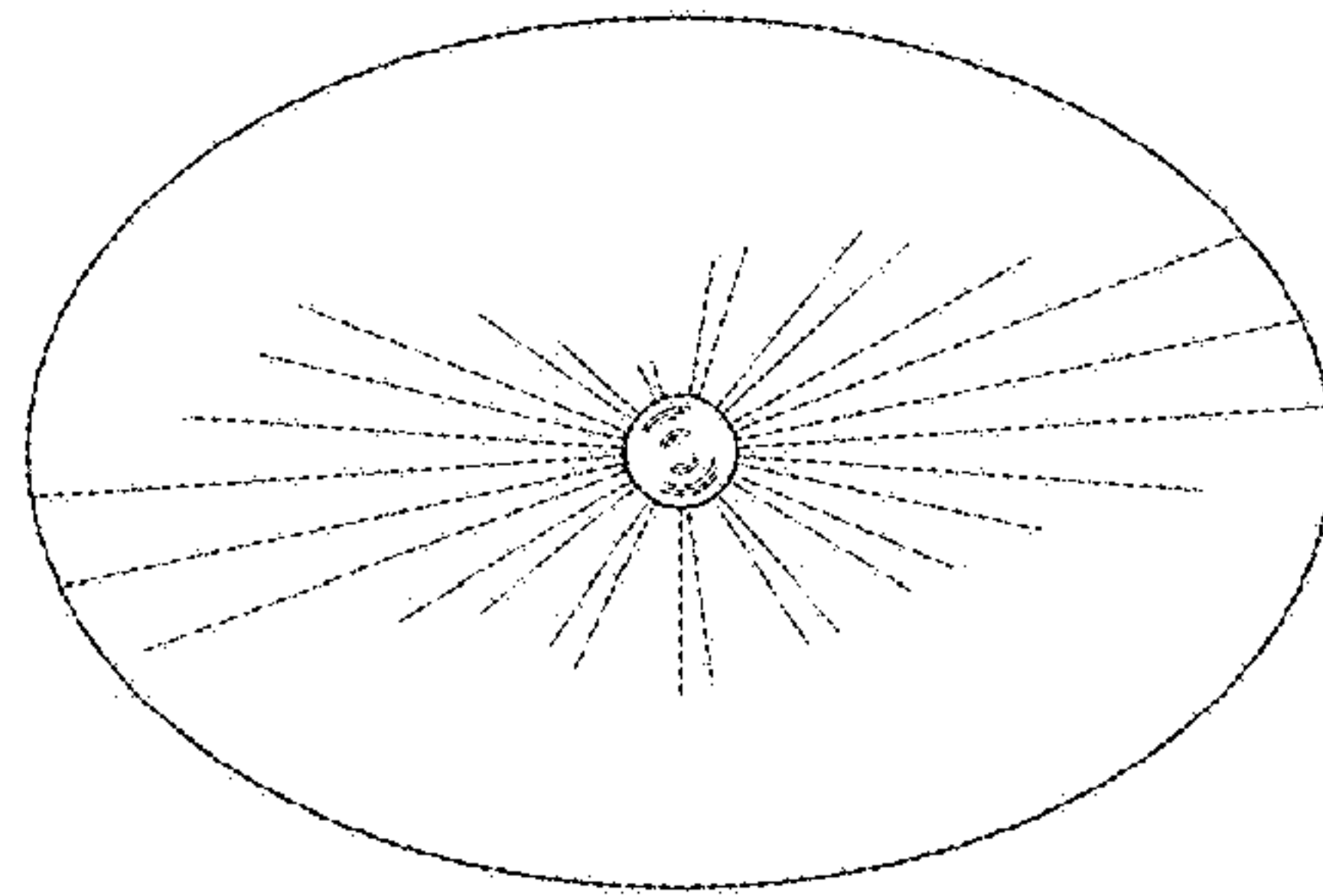

FIG. 4

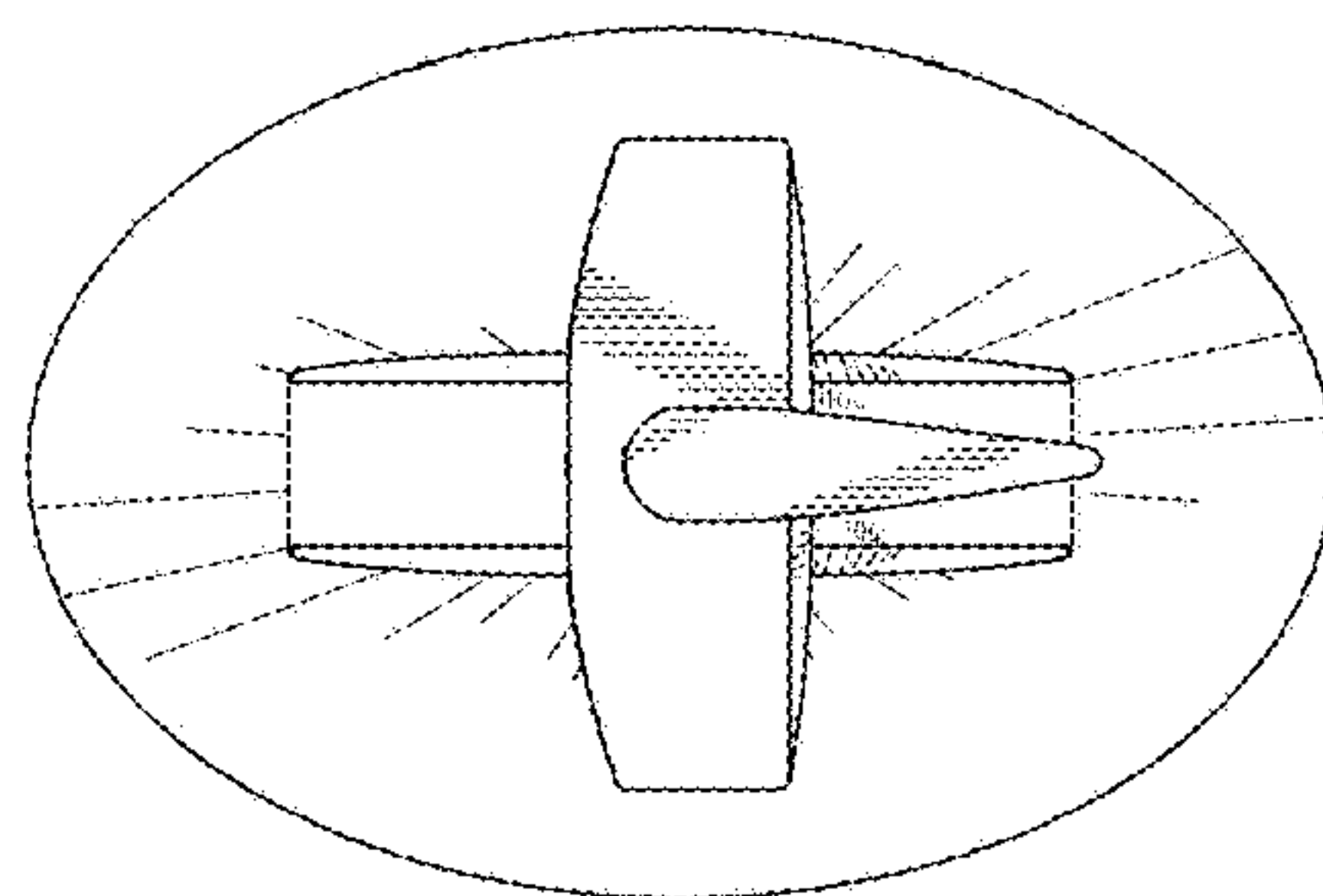

FIG. 5

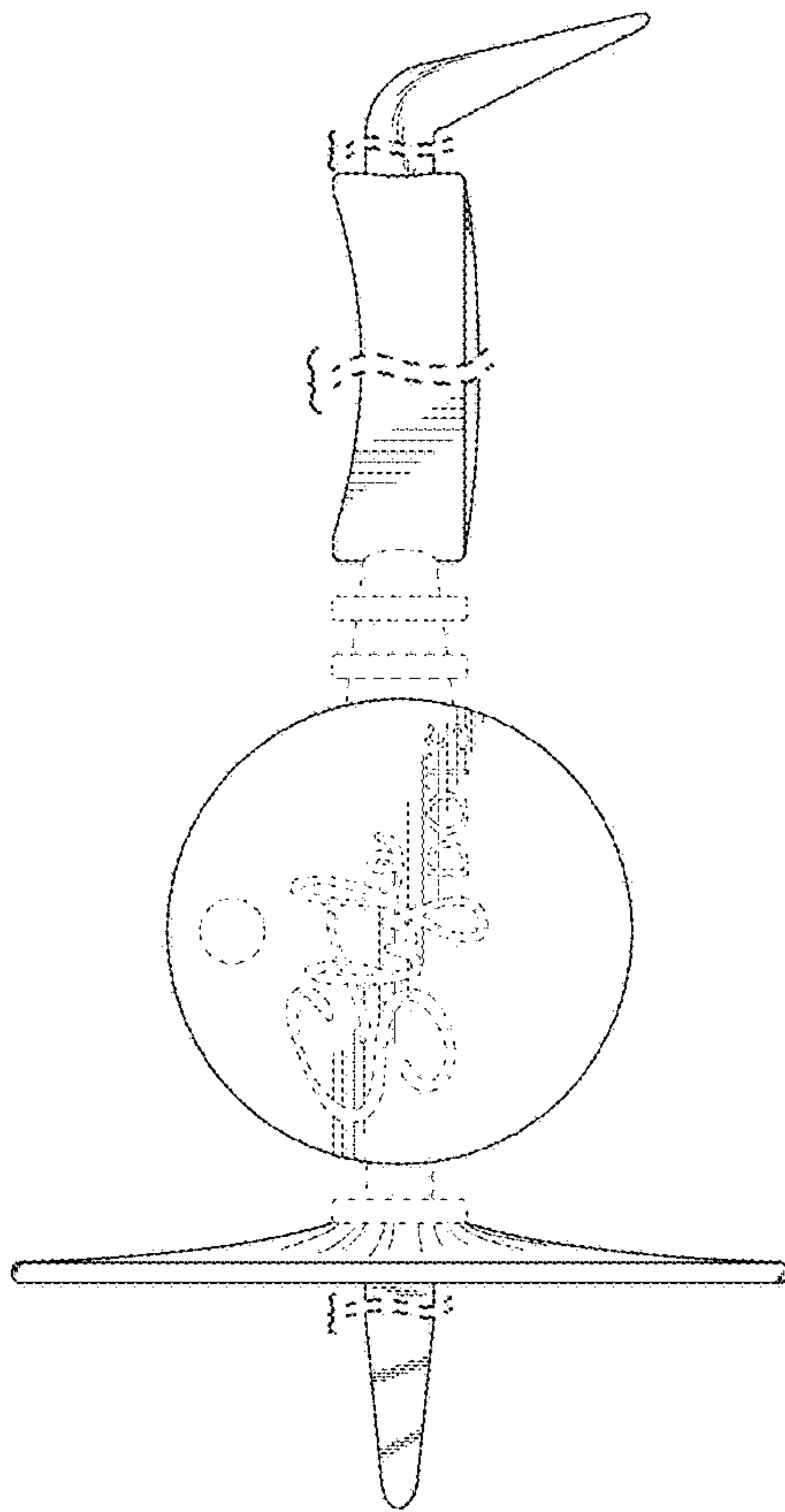

FIG. 6

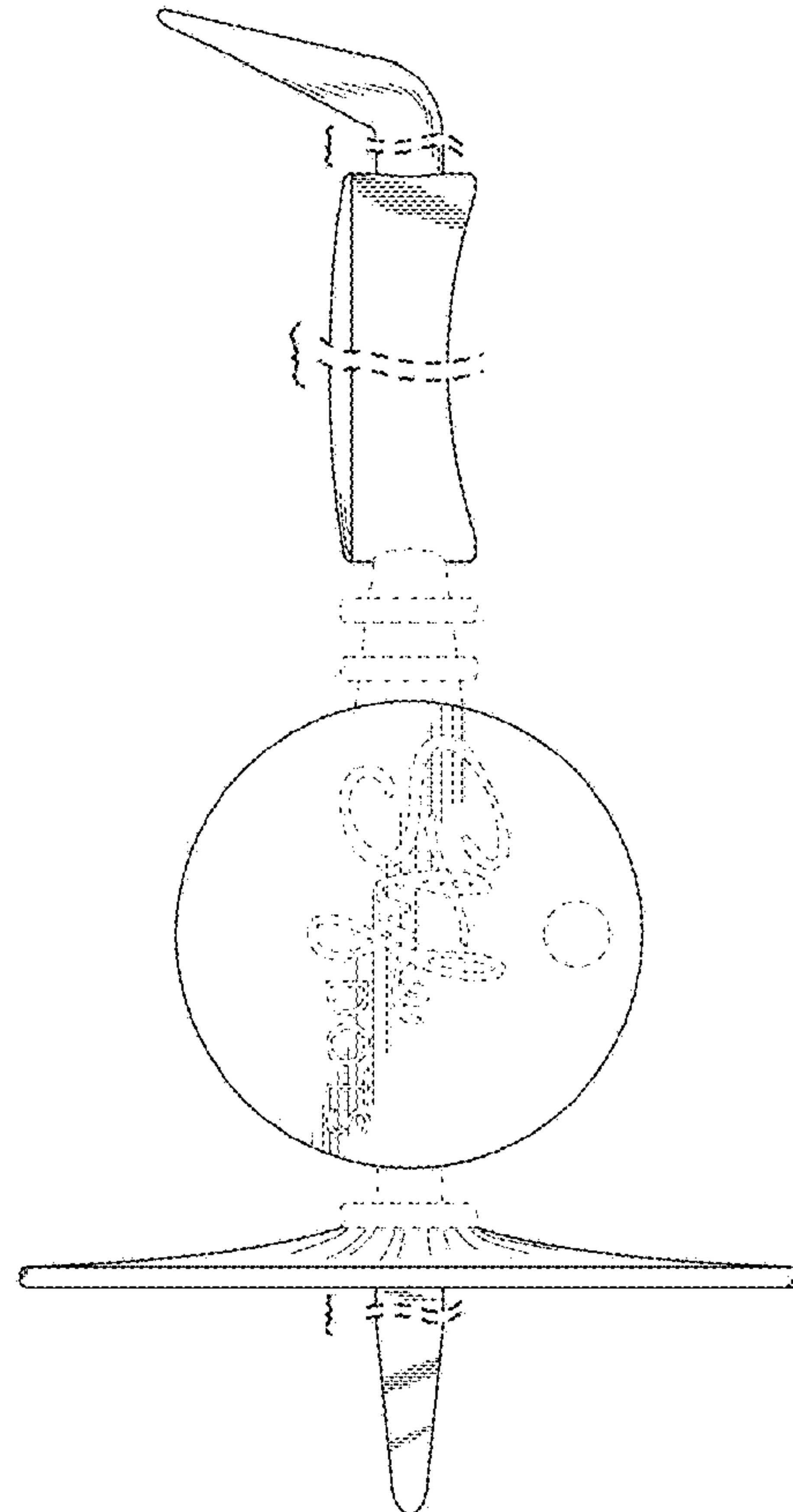

FIG. 7