



US00D914509S

(12) **United States Design Patent**
Matsuishi

(10) **Patent No.:** **US D914,509 S**
(45) **Date of Patent:** **** Mar. 30, 2021**

(54) **BOTTLE FOR COSMETICS**
(71) Applicant: **Midori Matsuishi**, Tokyo (JP)
(72) Inventor: **Midori Matsuishi**, Tokyo (JP)
(73) Assignee: **SHISEIDO CO., LTD.**, Tokyo (JP)
(**) Term: **15 Years**
(21) Appl. No.: **29/678,874**

D649,469 S * 11/2011 Fine D9/551
D654,799 S * 2/2012 Liu D9/560
D655,200 S * 3/2012 Gross B65D 83/56
D9/687
D682,706 S * 5/2013 Weil D9/560
D694,622 S * 12/2013 Bulens D9/432
D703,061 S * 4/2014 de Lima Paschoal D9/529
D704,065 S * 5/2014 de Lima Paschoal D9/529
D709,379 S * 7/2014 Moretti D9/529
D712,596 S * 9/2014 Lee D28/85
D712,746 S * 9/2014 Widdison D9/529
D719,027 S * 12/2014 Rathbone D9/529

(Continued)

(22) Filed: **Jan. 31, 2019**
(51) **LOC (13) Cl.** **09-01**
(52) **U.S. Cl.**
USPC **D9/574; D9/560**
(58) **Field of Classification Search**
USPC D9/432, 529, 560, 563, 566, 567,
D9/573-575; D28/85
CPC B65D 21/0231; B65D 2501/0081; A45D
34/00
See application file for complete search history.

FOREIGN PATENT DOCUMENTS

CN 305091177 * 4/2019
CN 305134899 * 4/2019
WO D201824-001 * 10/2018

Primary Examiner — Brett Miller
Assistant Examiner — Rani J Abdallah
(74) *Attorney, Agent, or Firm* — Manabu Kanesaka

(57) **CLAIM**

The ornamental design for a bottle for cosmetics, as shown and described.

(56) **References Cited**

U.S. PATENT DOCUMENTS

D325,523 S * 4/1992 Restrepo D9/529
D423,922 S * 5/2000 Ohchi D9/503
D426,774 S * 6/2000 Jauffret D9/573
D478,690 S * 8/2003 Sgariboldi D28/85
D479,017 S * 8/2003 Sgariboldi D28/85
D479,018 S * 8/2003 Sgariboldi D28/85
D501,279 S * 1/2005 Dittmer D28/85
D531,043 S * 10/2006 Houtart D9/560
D546,192 S * 7/2007 Faillant Dumas D9/573
D551,982 S * 10/2007 Forman D9/529
D577,600 S * 9/2008 Kim D9/573
D590,720 S * 4/2009 Oates D9/560
D618,106 S * 6/2010 Boudard D9/529
D629,698 S * 12/2010 Kim D9/574
D629,699 S * 12/2010 Kim D9/574
D639,669 S * 6/2011 Adler D9/575
D644,108 S * 8/2011 Vila Calvo D9/560

DESCRIPTION

FIG. 1 is a perspective view of a bottle for cosmetics showing my new design;
FIG. 2 is a front view thereof, a rear view being identical to the front view thereof;
FIG. 3 is a plan view thereof;
FIG. 4 is a bottom view thereof;
FIG. 5 is a right side view thereof, a left side view being identical to the right side view thereof; and,
FIG. 6 is a cross-sectional view thereof along the line 6-6 in FIG. 5.
The broken lines depict portions of the bottle for cosmetics that form no part of claimed design.

1 Claim, 1 Drawing Sheet

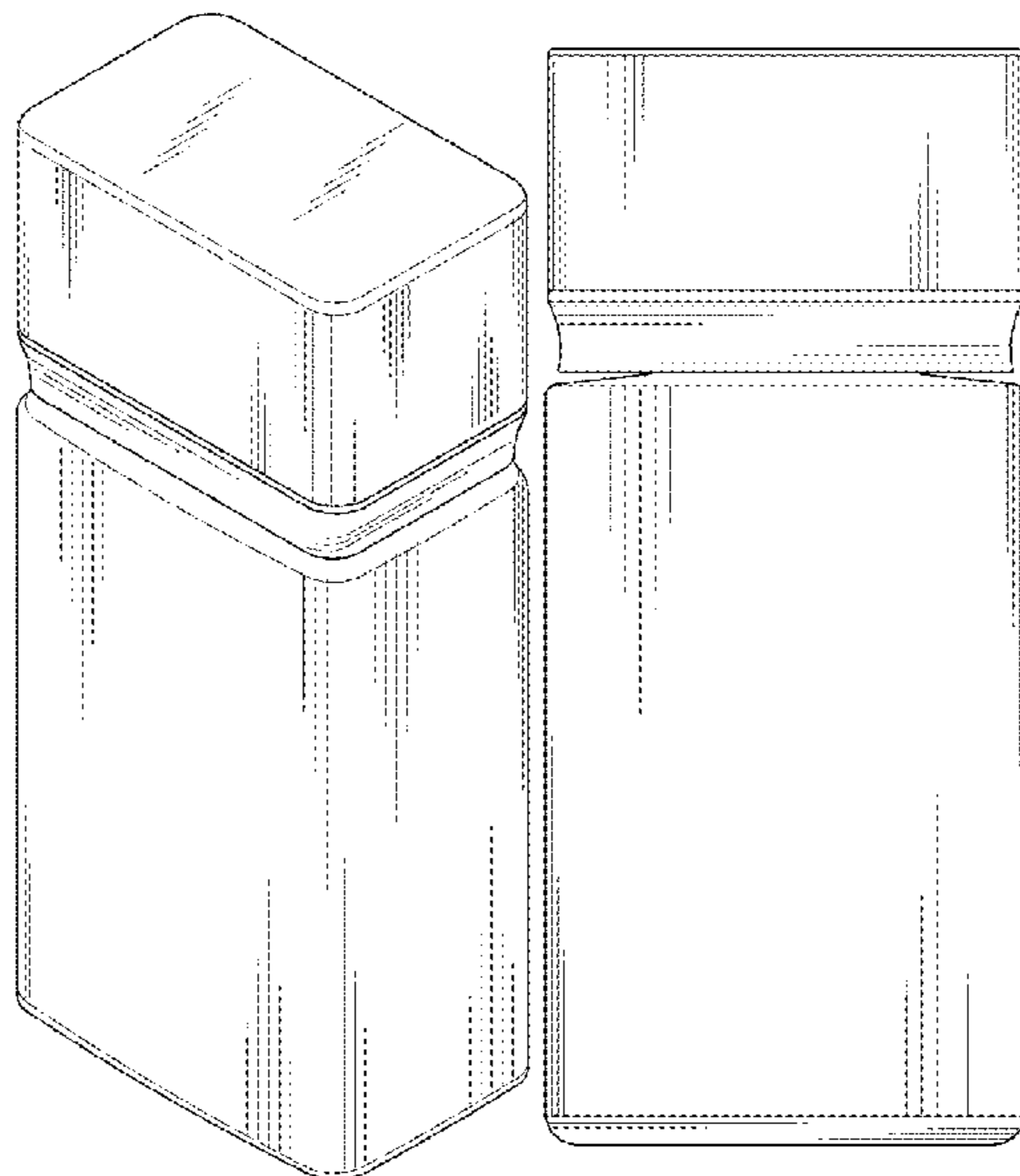

(56)

References Cited

U.S. PATENT DOCUMENTS

D734,550	S	*	7/2015	Schlatter	D9/560
D747,969	S	*	1/2016	Baron	D9/529
D757,564	S	*	5/2016	Santos	D9/694
D777,037	S	*	1/2017	Serafin	D9/560
D796,964	S	*	9/2017	Staab	D9/560
D799,754	S	*	10/2017	Chertoff	D9/560
D808,280	S	*	1/2018	Nagata	D9/560
D814,308	S	*	4/2018	Aebi	D9/560
D816,506	S	*	5/2018	Jones	D9/560
D829,554	S	*	10/2018	Liston	D9/529
D831,495	S	*	10/2018	Papiernik-Berkhauer	D9/560
D833,879	S	*	11/2018	Staab	D9/529
D837,060	S	*	1/2019	Riedel	D9/529
D838,184	S	*	1/2019	Riedel	D9/574
D840,242	S	*	2/2019	Riedel	D9/574
D853,035	S	*	7/2019	Moretti	D9/529
D855,890	S	*	8/2019	Lovejoy	D28/85
D865,297	S	*	10/2019	De Martino	D9/560
D870,560	S	*	12/2019	Yoshioka	B65D 83/56 D9/529
D873,147	S	*	1/2020	Aboabdo	D9/560
D883,793	S	*	5/2020	Macaluso	D9/529
D884,480	S	*	5/2020	Karekar	D9/529
D891,931	S	*	8/2020	Tidwell	D9/529
D902,723	S	*	11/2020	Shiota	D9/504
D902,724	S	*	11/2020	Shiota	D9/503
D904,691	S	*	12/2020	Wolfe	D28/85
D906,117	S	*	12/2020	Shiota	D9/503

* cited by examiner

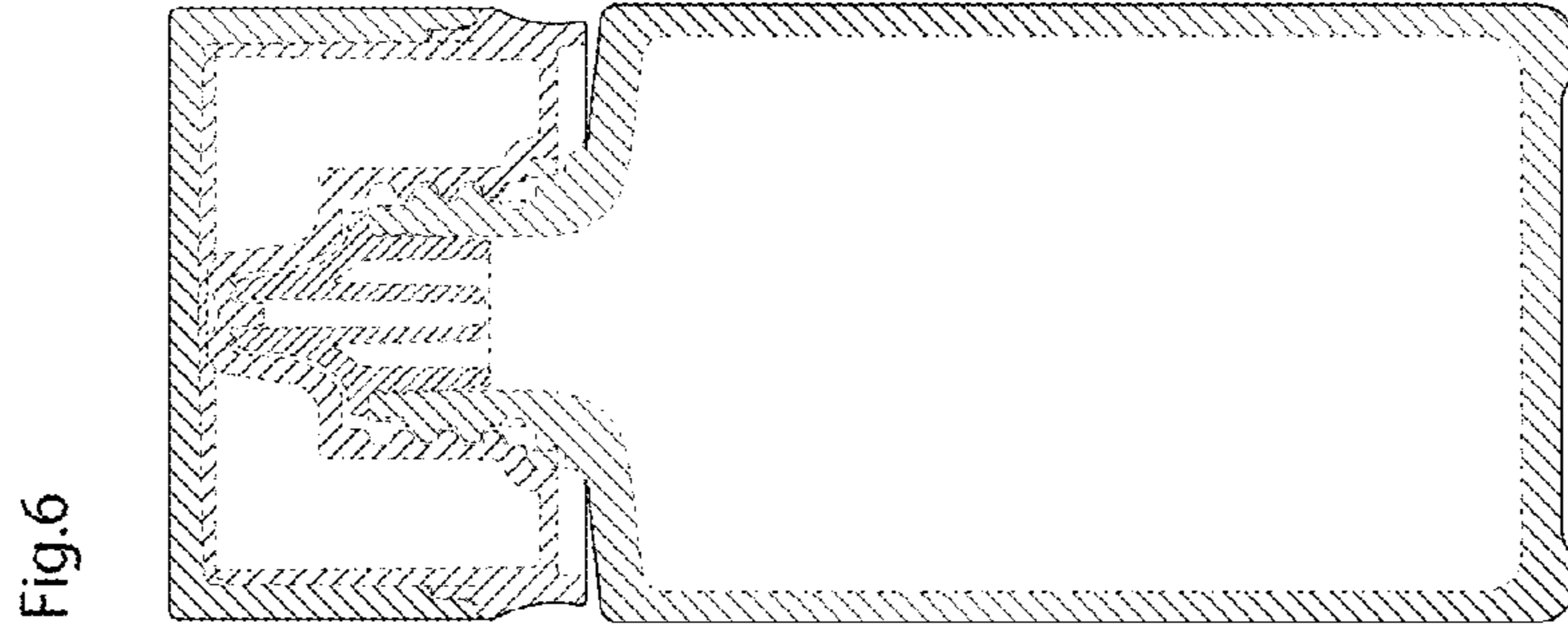

Fig.6

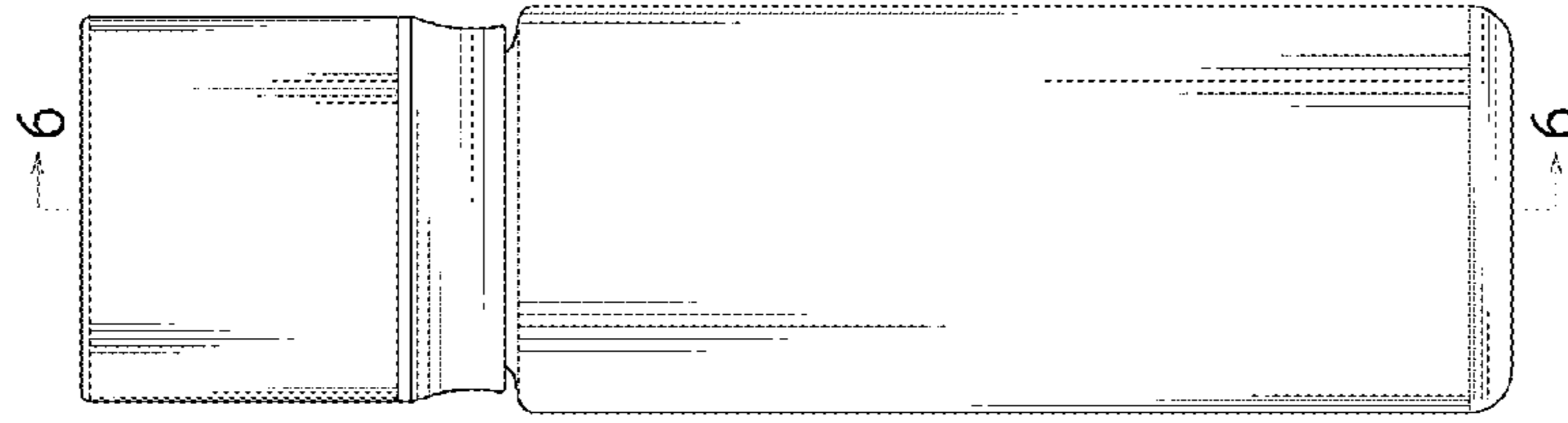

Fig.5

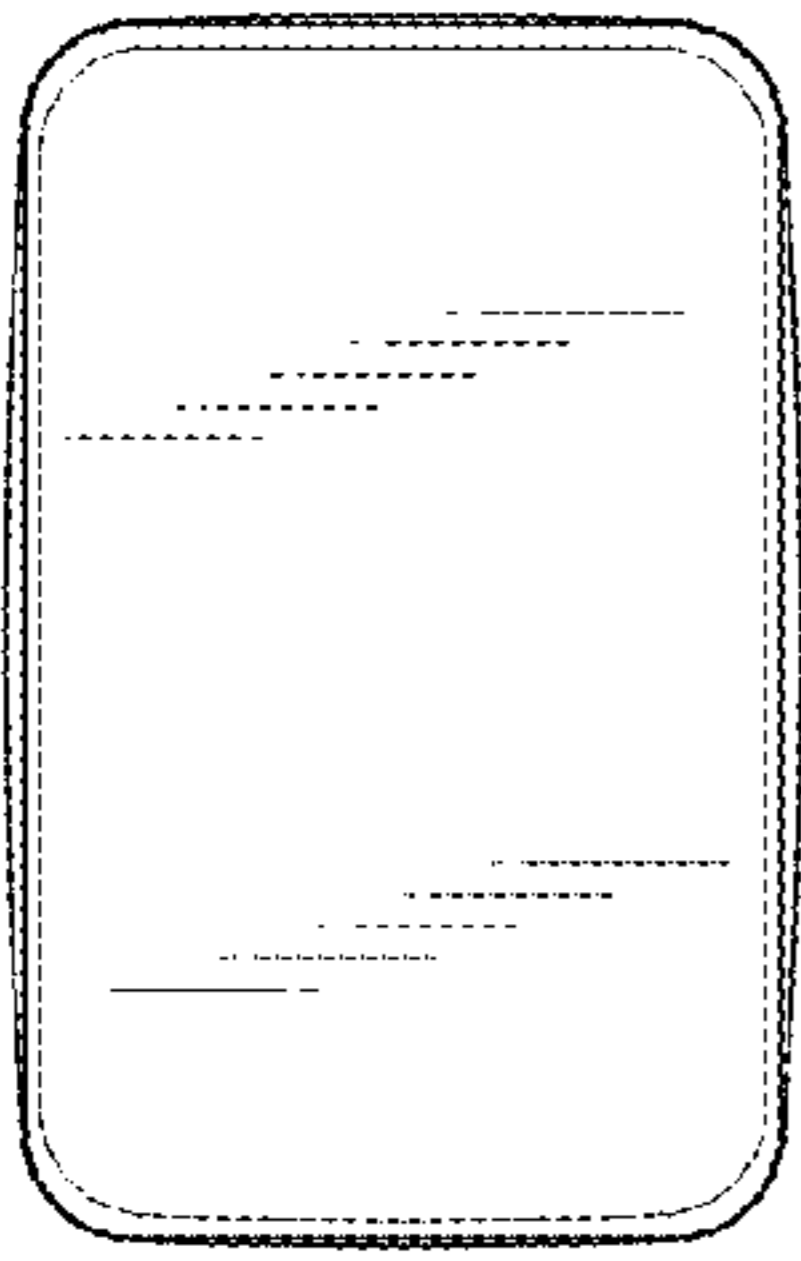

Fig.3

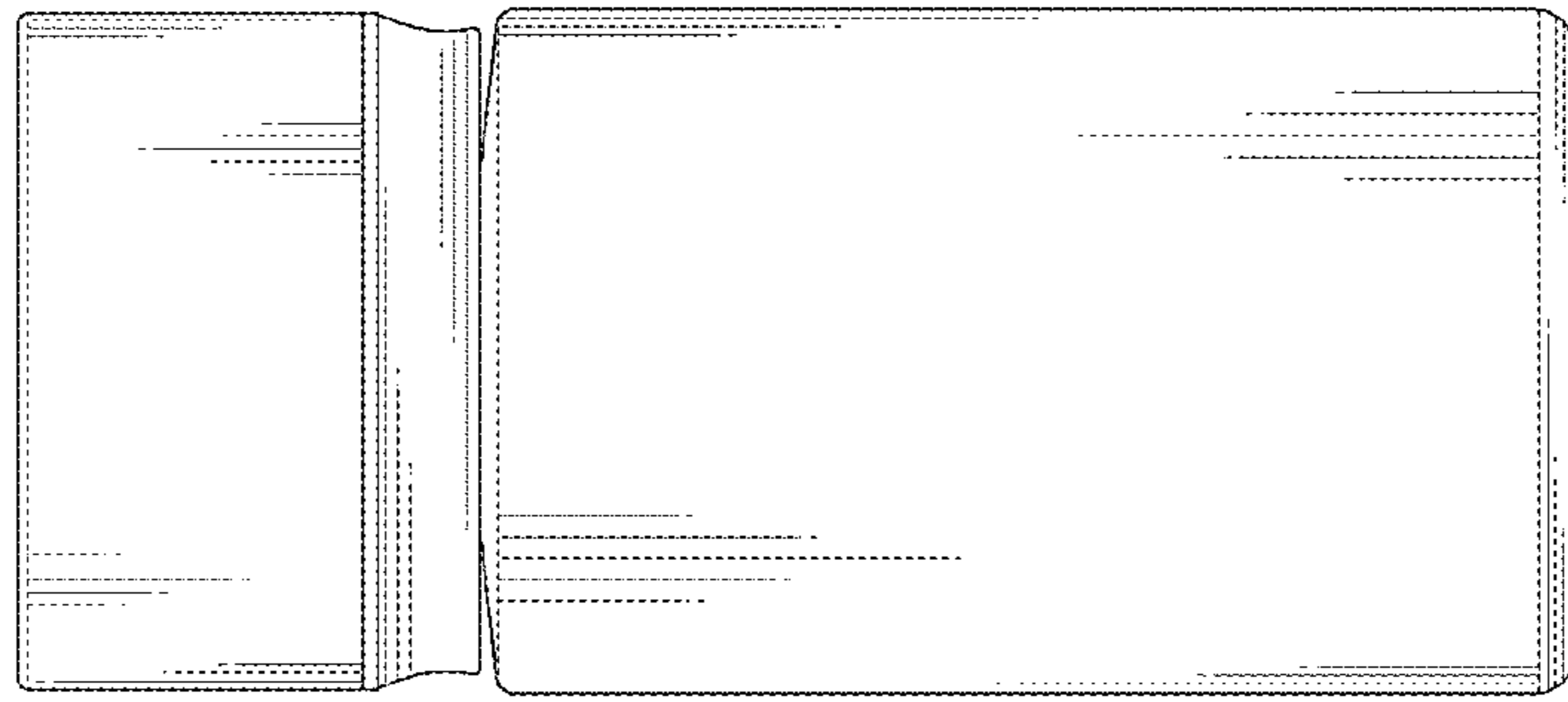

Fig.2

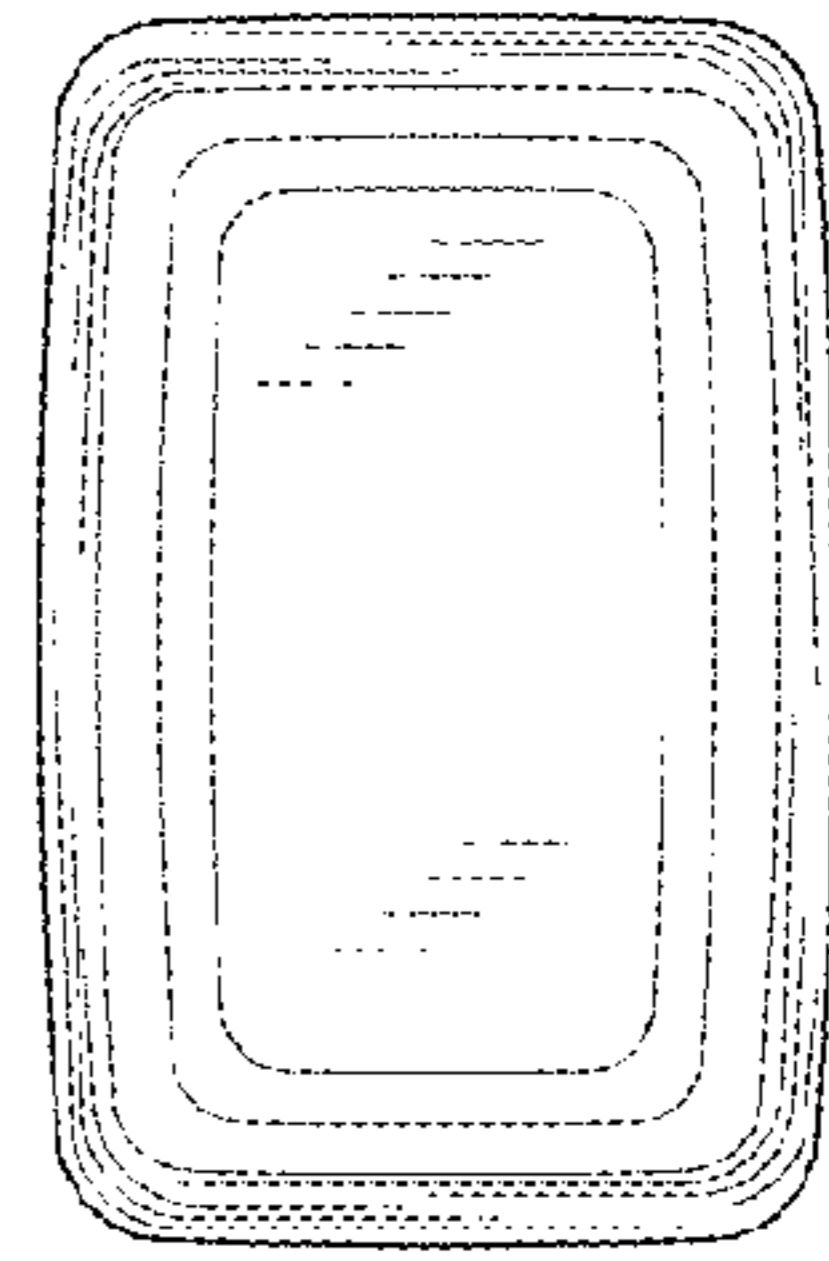

Fig.4

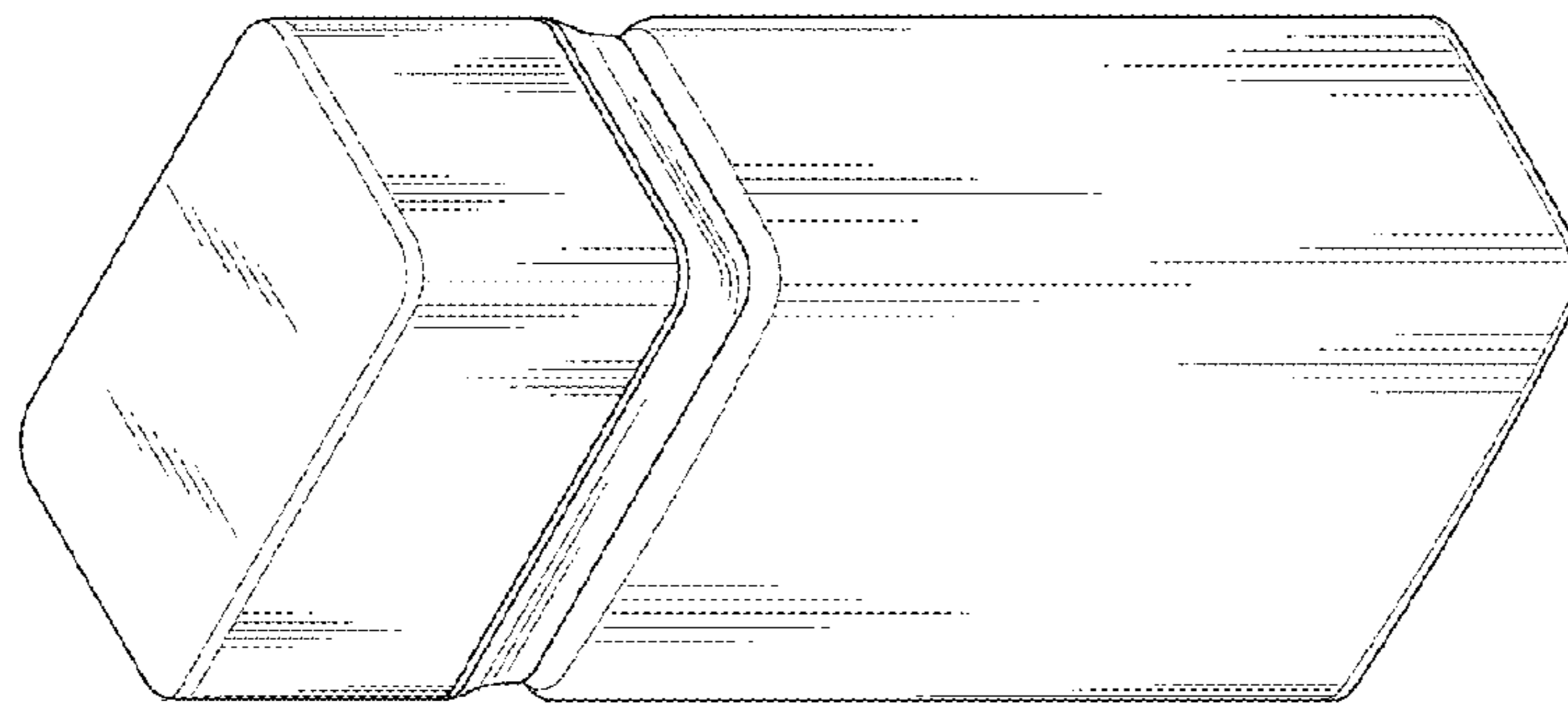

Fig.1