



US00D914401S

(12) **United States Design Patent**  
**Leng**

(10) **Patent No.:** **US D914,401 S**  
(45) **Date of Patent:** **\*\* Mar. 30, 2021**

(54) **STORAGE CABINET**

(71) Applicant: **New-Tec Integration (Xiamen) Co., Ltd.**, Xiamen (CN)

(72) Inventor: **Luhao Leng**, Xiamen (CN)

(73) Assignee: **New-Tec Integration (Xiamen) Co., Ltd.**, Xiamen (CN)

(\*\*) Term: **15 Years**

(21) Appl. No.: **29/705,334**

(22) Filed: **Sep. 11, 2019**

(30) **Foreign Application Priority Data**

Mar. 15, 2019 (CN) ..... 201930107567.2

(51) **LOC (13) Cl.** ..... **06-04**

(52) **U.S. Cl.**  
USPC ..... **D6/667; D6/668.1**

(58) **Field of Classification Search**  
USPC ..... D6/661, 663, 667, 668, 668.1, 668.2, D6/671, 671.1, 672, 675, 682.1; D34/7, D34/19, 25; D25/33

CPC ..... A47B 47/00; A47B 47/0091; A47B 47/04; A47B 47/047; A47B 47/05; A47B 87/02; A47B 67/00; A47B 67/04

See application file for complete search history.

(56) **References Cited**

**U.S. PATENT DOCUMENTS**

5,205,630 A \* 4/1993 Welch ..... A47B 47/021 108/107  
D422,807 S \* 4/2000 Tisbo ..... D6/667  
D513,913 S \* 1/2006 Harwanko ..... D6/559  
D676,149 S \* 2/2013 Vogler ..... D25/33

D730,541 S \* 5/2015 Phillips ..... D25/33  
D864,622 S \* 10/2019 Lim ..... D6/663  
D870,494 S \* 12/2019 Leng ..... D6/667  
D870,495 S \* 12/2019 Guo ..... A47B 47/021 D6/671  
D871,114 S \* 12/2019 Nicoll ..... A47B 67/00 D6/671.1  
D880,906 S \* 4/2020 Leng ..... D6/663  
D880,907 S \* 4/2020 Leng ..... D6/667  
2005/0146255 A1 \* 7/2005 Sabo ..... A47B 67/00 312/316  
2014/0158702 A1 \* 6/2014 Phillips ..... A47B 47/042 220/832

\* cited by examiner

*Primary Examiner* — Cathron C Brooks

(74) *Attorney, Agent, or Firm* — Cooper Legal Group, LLC

(57) **CLAIM**

The ornamental design for a storage cabinet, as shown and described.

**DESCRIPTION**

FIG. 1 is a front elevation view of a storage cabinet showing the new design;  
FIG. 2 is a rear elevation view thereof;  
FIG. 3 is a left side elevation view thereof;  
FIG. 4 is a right side elevation view thereof;  
FIG. 5 is a top plan view thereof;  
FIG. 6 is a bottom plan view thereof;  
FIG. 7 is a perspective view thereof in a first position;  
FIG. 8 is a perspective view thereof in a second position; and,  
FIG. 9 is an enlarged detailed view showing a portion of the storage cabinet taken from the encircled area 9 shown in FIG. 8.

**1 Claim, 9 Drawing Sheets**

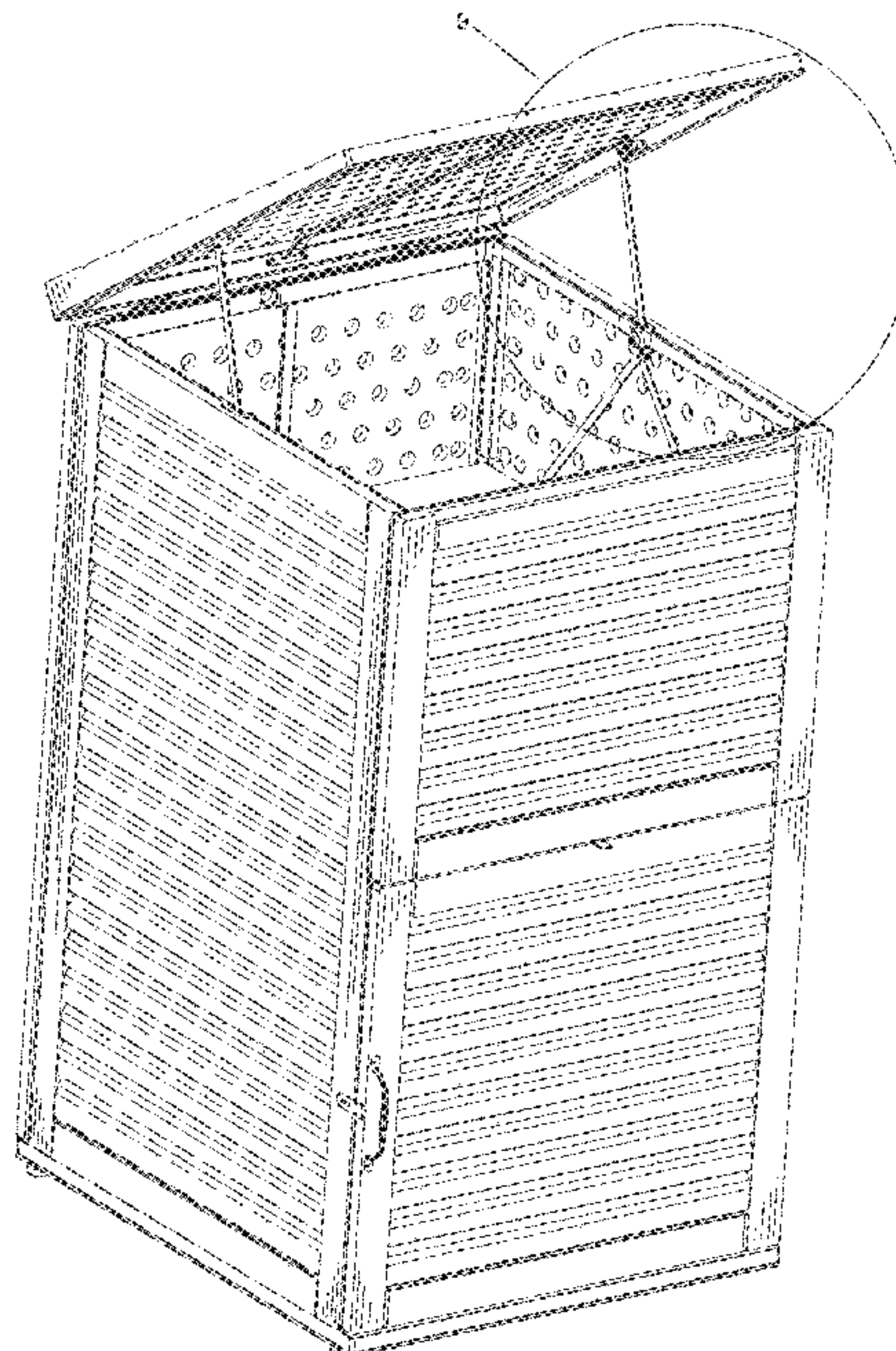

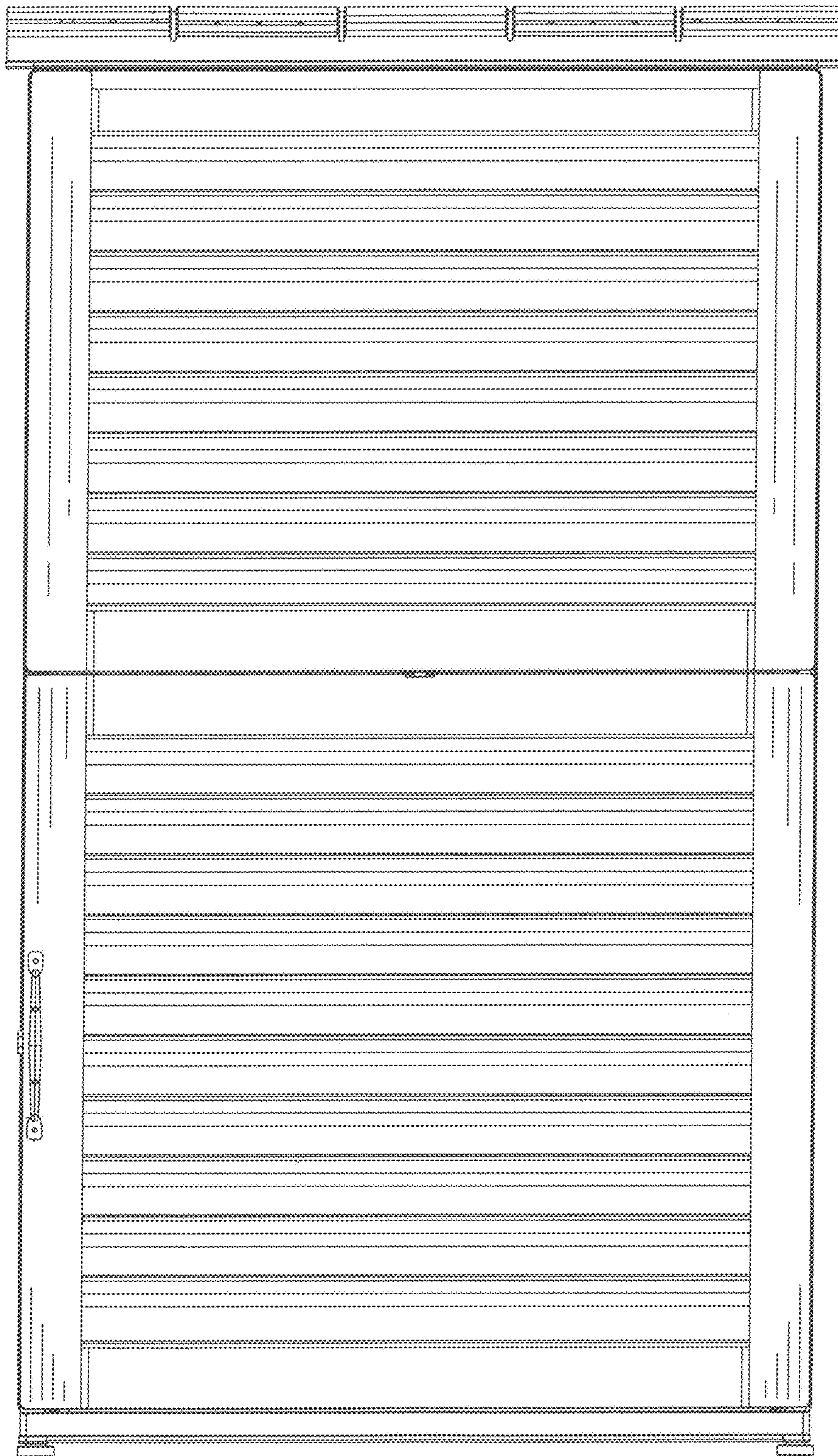

Fig. 1



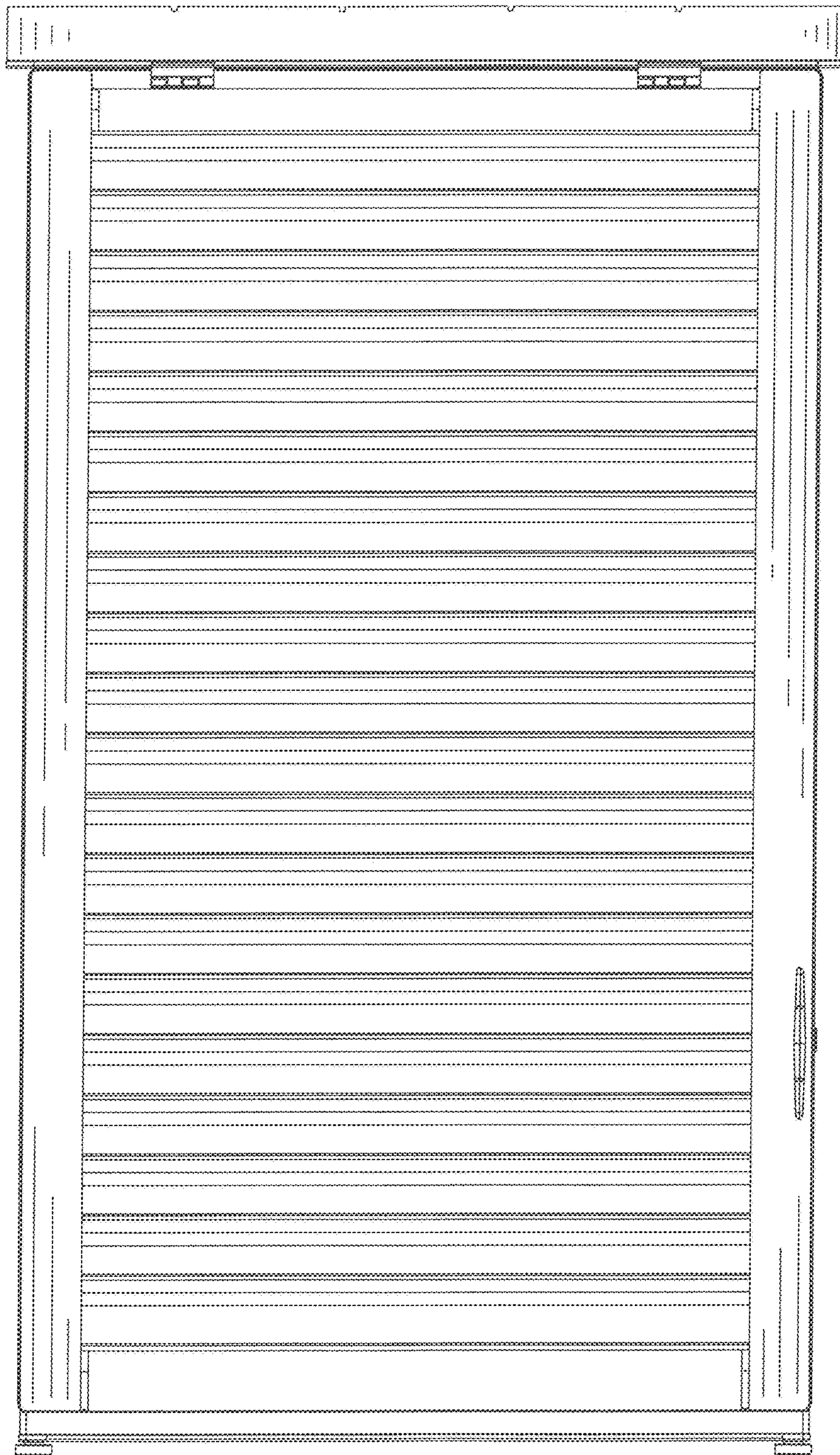

Fig. 2

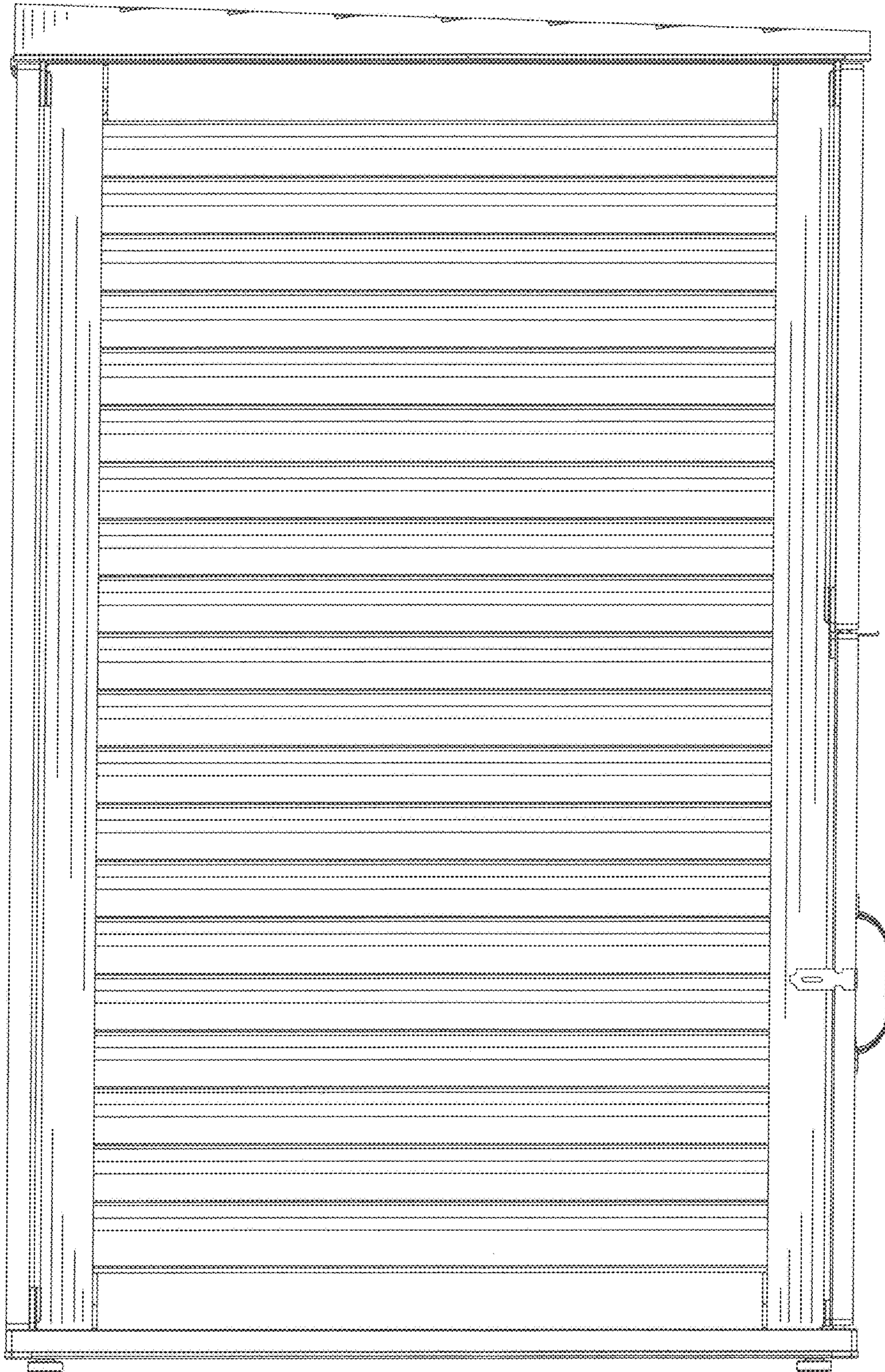

Fig. 3



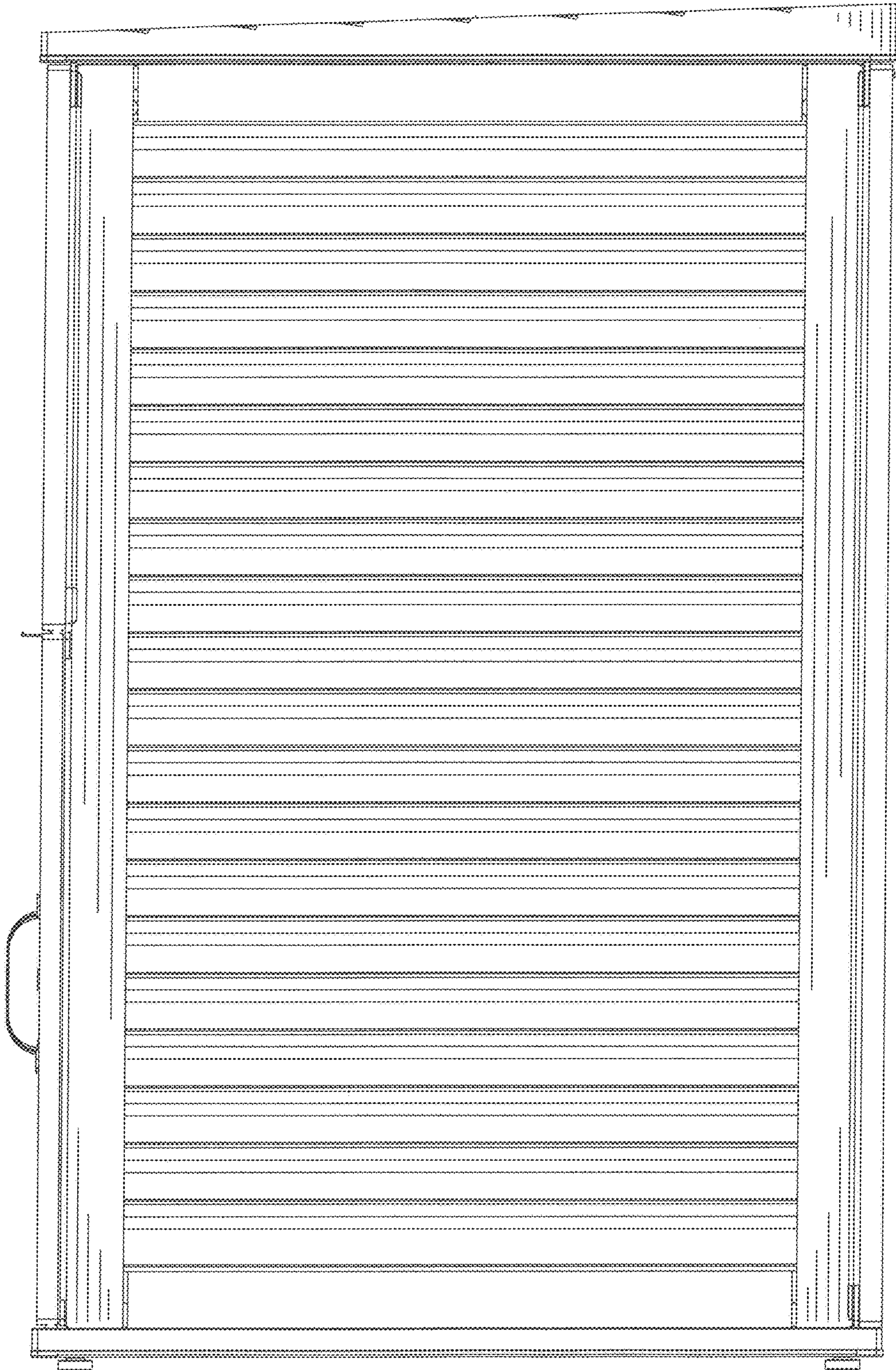

Fig. 4

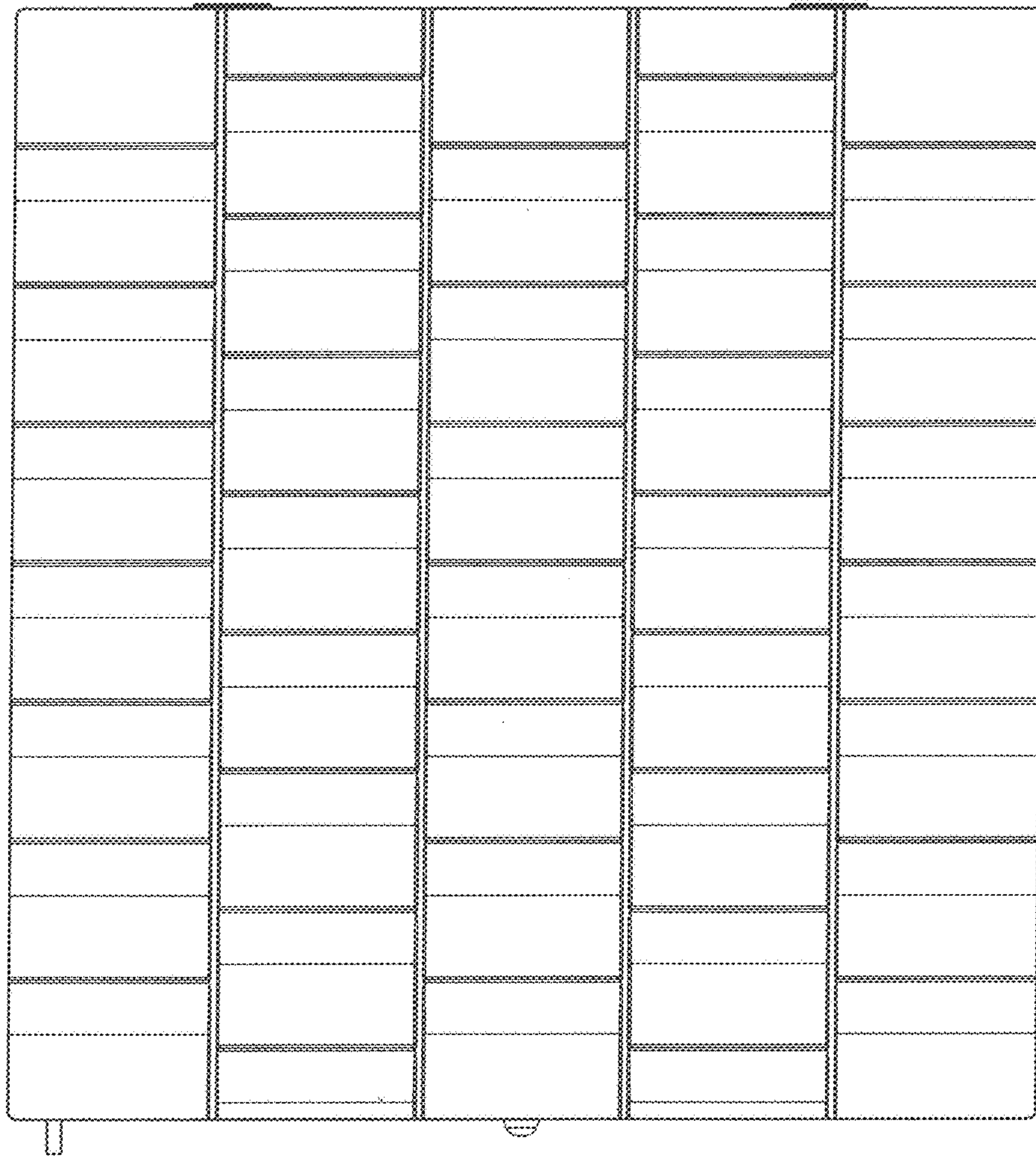

Fig. 5



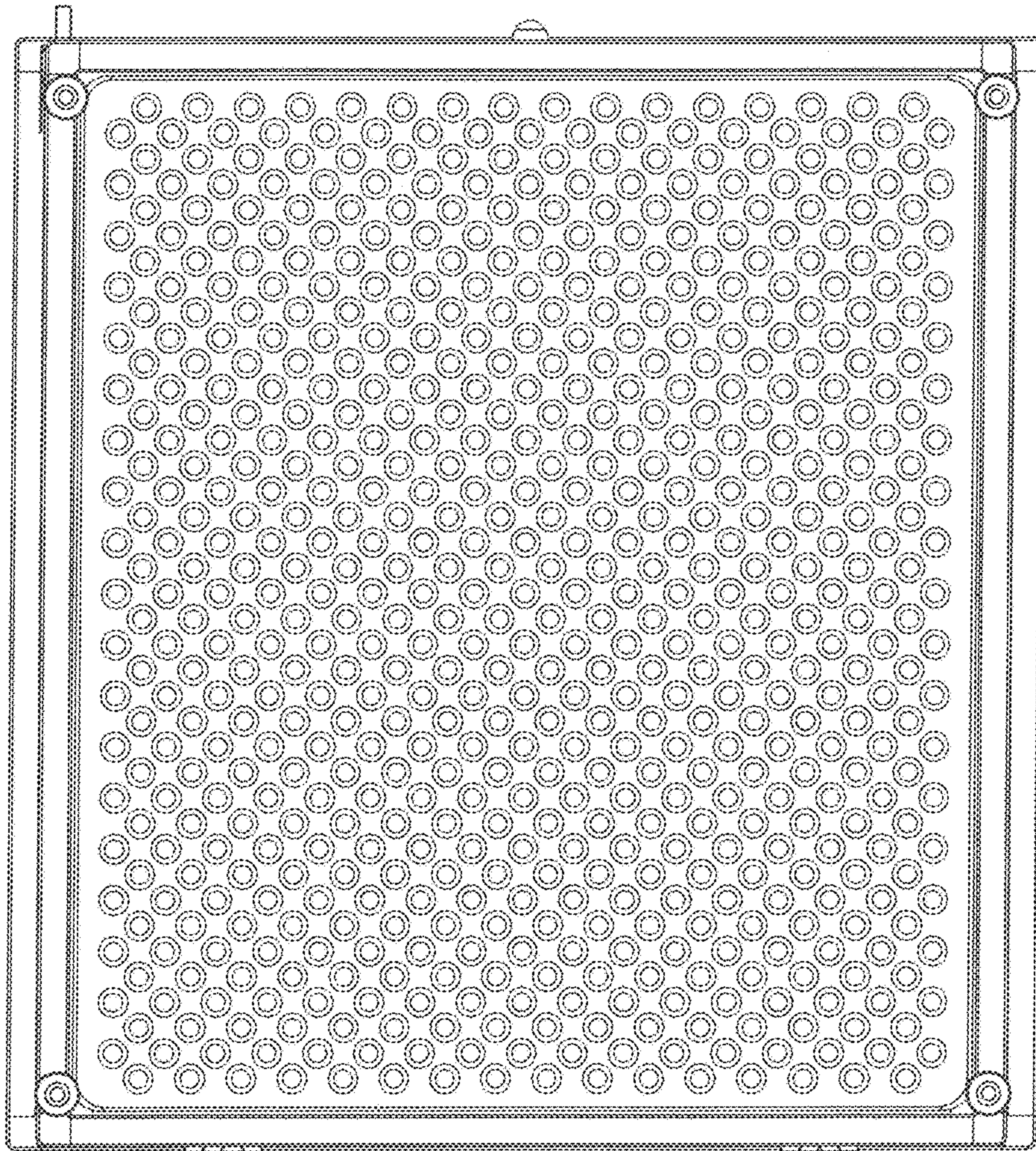

Fig. 6



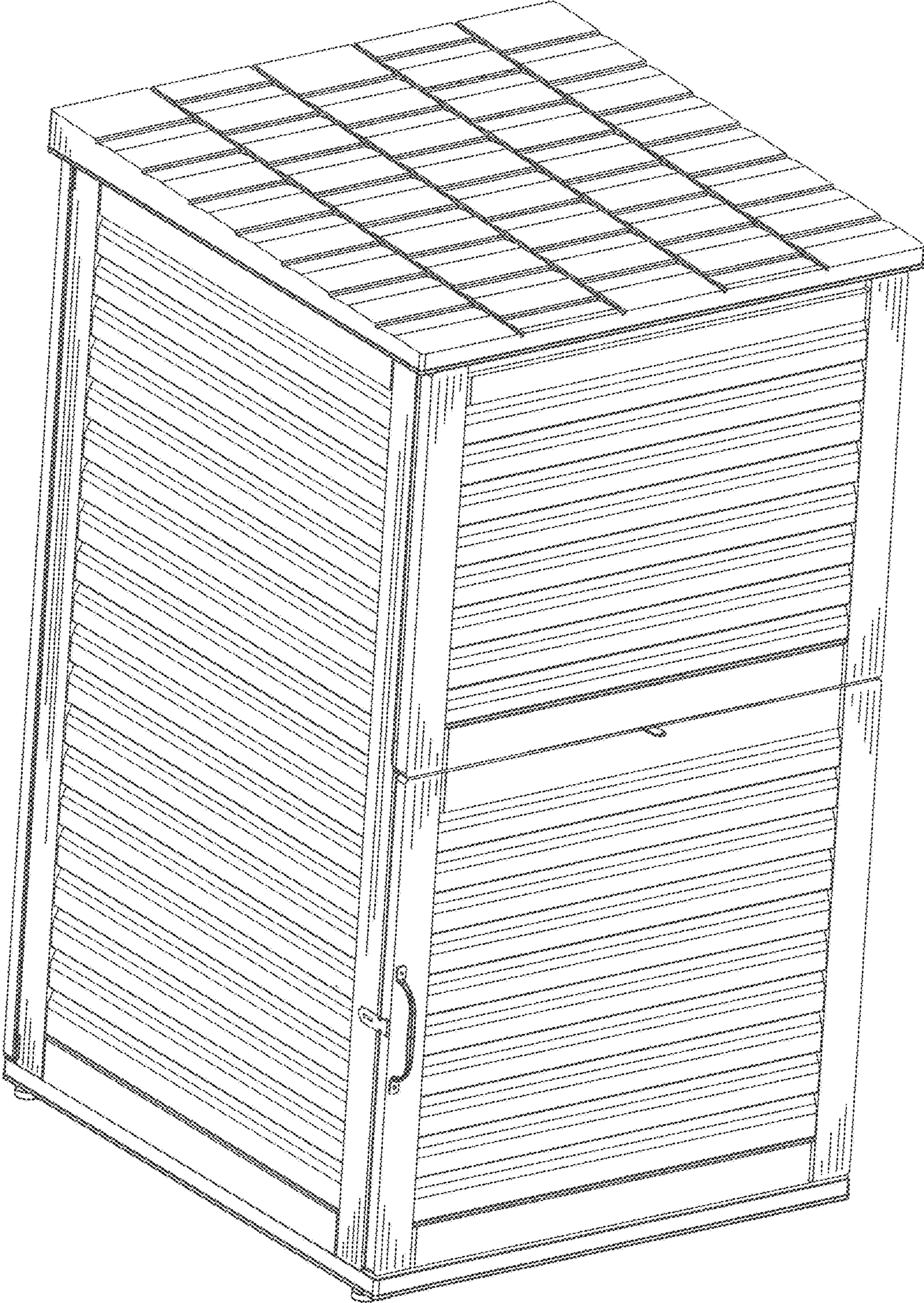

Fig. 7



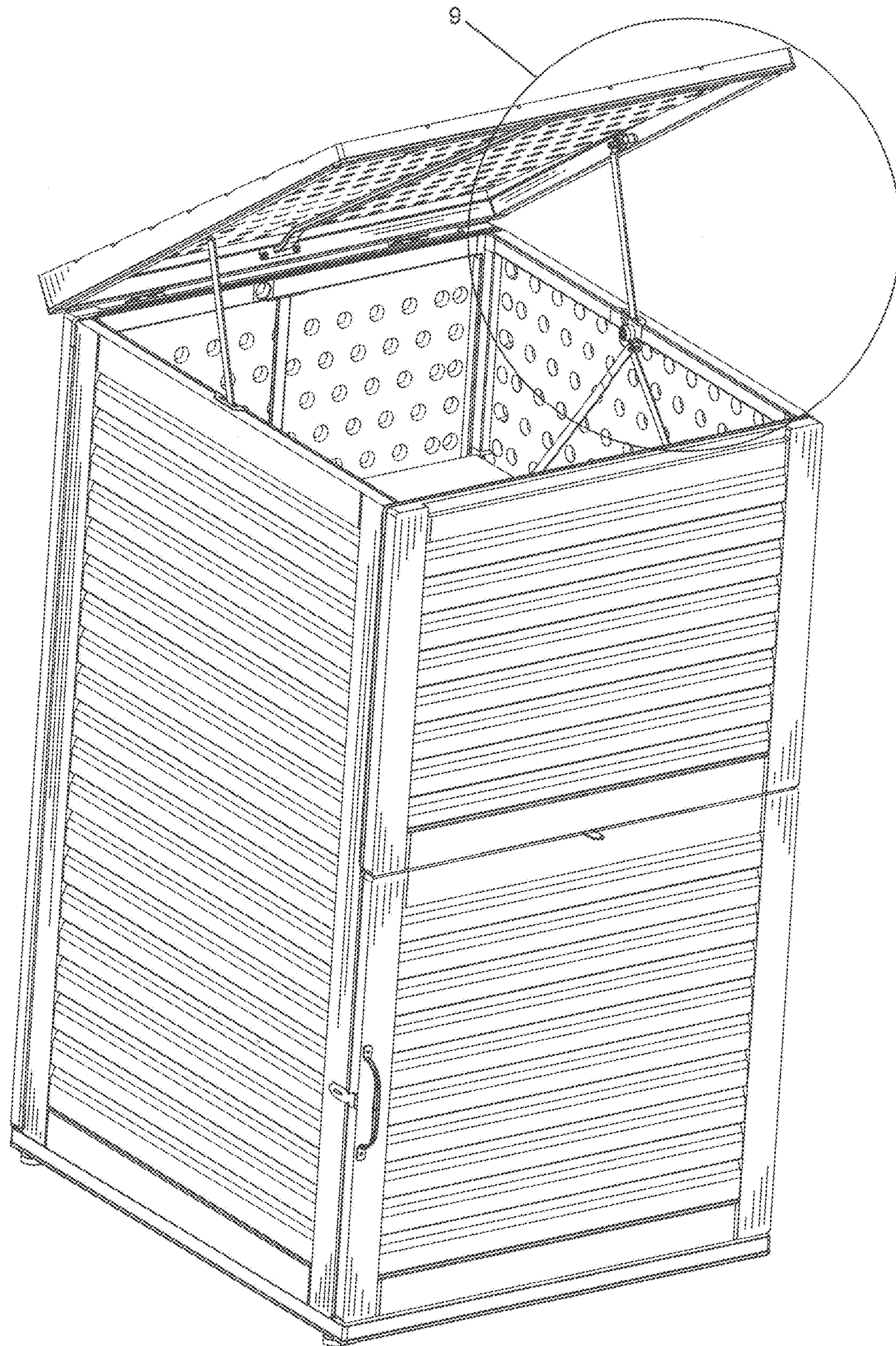

Fig. 8



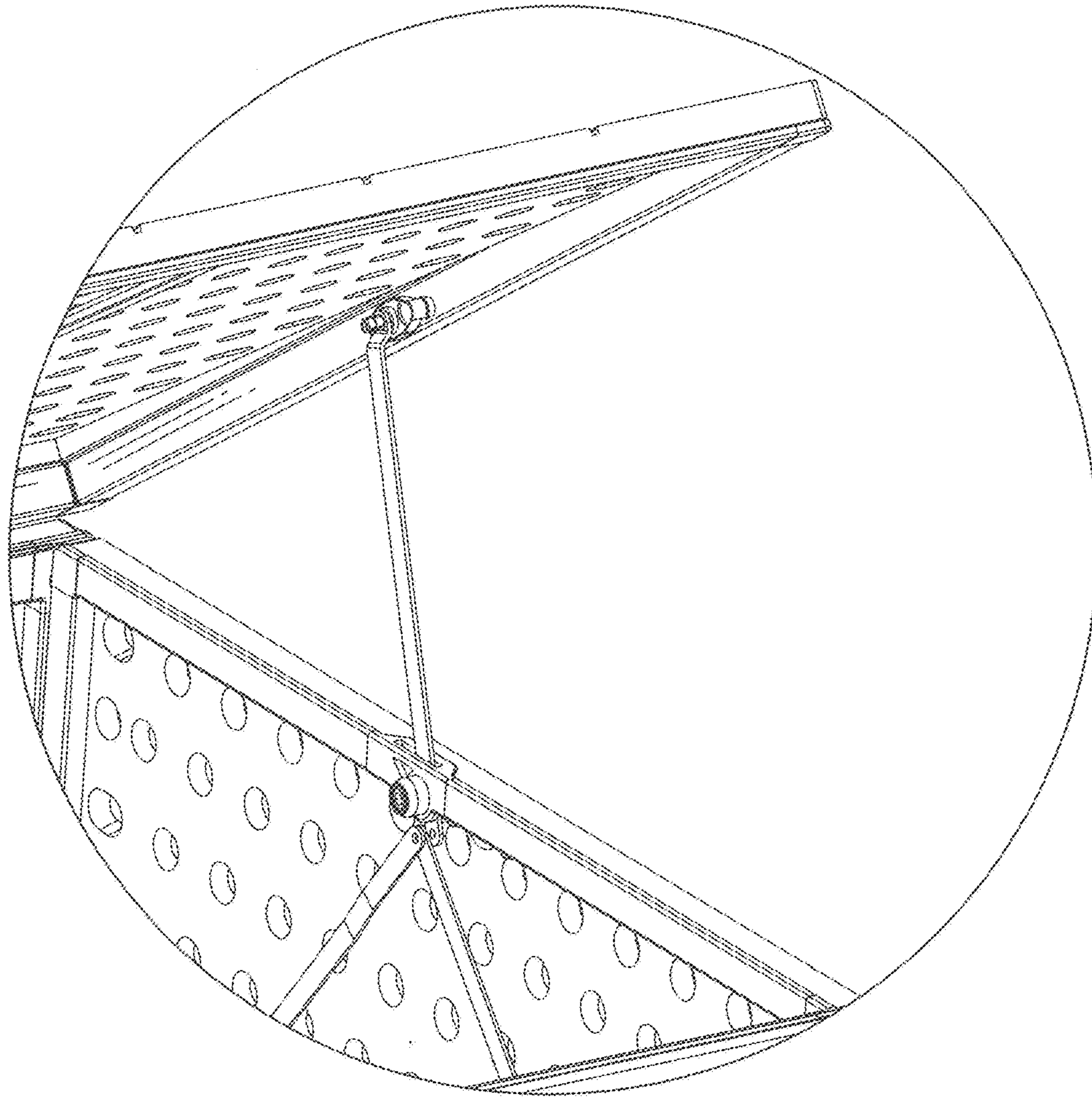

Fig. 9