



US00D914354S

(12) **United States Design Patent** (10) **Patent No.:** **US D914,354 S**
Verfl et al. (45) **Date of Patent:** **** Mar. 30, 2021**

(54) **SHOE UPPER**
(71) Applicant: **Cole Haan LLC**, New York, NY (US)
(72) Inventors: **Mattias Verfl**, Greenland, NH (US);
Pablo Chao, Greenland, NH (US)
(73) Assignee: **COLE HAAN LLC**, Greenland, NH (US)
(**) Term: **15 Years**
(21) Appl. No.: **29/672,153**
(22) Filed: **Dec. 3, 2018**
(51) **LOC (13) Cl.** **02-04**
(52) **U.S. Cl.**
USPC **D2/973**
(58) **Field of Classification Search**
USPC D2/896, 897, 902, 907, 908, 911, 912,
D2/923, 929, 935, 943-946, 948, 953,
D2/954, 959, 969, 970, 972-978
CPC A43B 13/00; A43B 13/02; A43B 13/04;
A43B 13/08; A43B 13/10; A43B 13/12;
A43B 13/141; A43B 13/143; A43B
13/16; A43B 13/181; A43B 13/023; A43B
13/026
See application file for complete search history.

(56) **References Cited**
U.S. PATENT DOCUMENTS
D572,451 S * 7/2008 Kuerbis D2/969
D578,746 S * 10/2008 Usui D2/969
D681,315 S * 5/2013 Della Valle D2/908
D789,044 S * 6/2017 Taestensen D2/908
D813,502 S * 3/2018 Weidenbach Gerbase D2/902
D816,973 S * 5/2018 Pauk D2/972
D849,374 S * 5/2019 Hardy D2/908
D864,529 S * 10/2019 Kasprzak D2/906
D865,336 S * 11/2019 Jenkins D2/907
D870,445 S * 12/2019 Cristobal D2/972

D880,819 S * 4/2020 Verfl D2/908
D889,093 S * 7/2020 Verfl D2/954
D890,506 S * 7/2020 Goto D2/972
D893,848 S * 8/2020 Swierszczyk D2/969
2019/0365049 A1* 12/2019 Verfl A43B 23/0275
2020/0170330 A1* 6/2020 Verfl A43B 23/025
2020/0170339 A1* 6/2020 Verfl A43B 13/181
(Continued)

OTHER PUBLICATIONS

ZeroGrand Stitchlite Knit Sneakers posted by Cole Haan posted date unknown, © Dillard's, [online], [site visited Sep. 17, 2020]. Available from Internet, <https://www.dillards.com/p/cole-haan-mens-generation-zero-grand-stitchlite-sneaker/510031243> (Year: 2020).*
(Continued)

Primary Examiner — Cynthia Ramirez
Assistant Examiner — Laura H Yu
(74) *Attorney, Agent, or Firm* — Thompson Coburn LLP

(57) **CLAIM**

The ornamental design for a shoe upper, as shown and described.

DESCRIPTION

FIG. 1 is a first perspective view of a shoe upper showing our new design;
FIG. 2 is a second perspective view thereof;
FIG. 3 is a front view thereof;
FIG. 4 is a left side view thereof;
FIG. 5 is a right side view thereof; and,
FIG. 6 is a top view thereof.
The broken lines immediately adjacent to the photographic area represent boundaries of the design and form no part thereof. The broken lines depicting the remainder of the shoe upper are for the purpose of illustrating portions of the shoe upper that form no part of the claimed design.

1 Claim, 6 Drawing Sheets

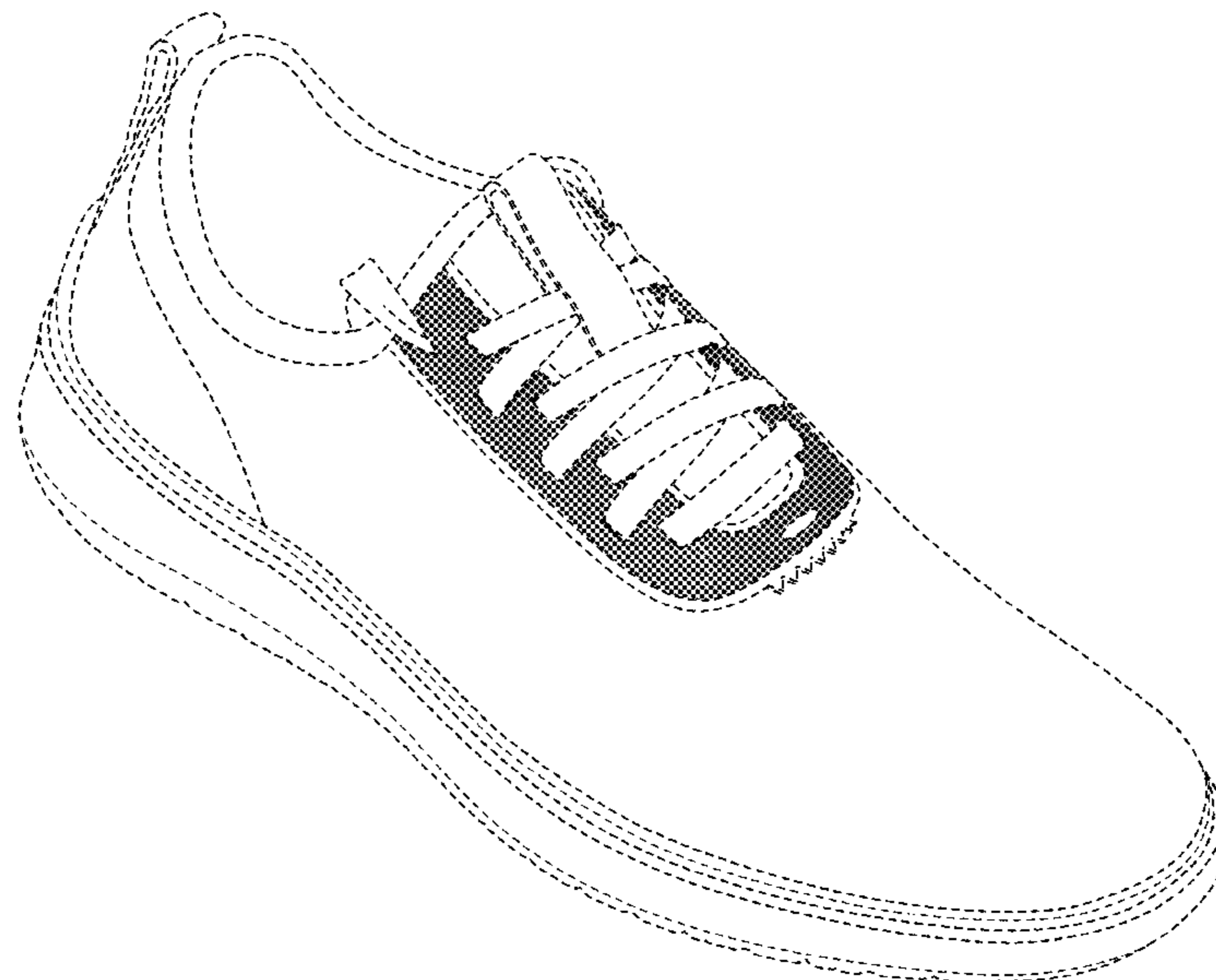

(56)

References Cited

U.S. PATENT DOCUMENTS

2020/0170349 A1* 6/2020 Verfl A43C 5/00

OTHER PUBLICATIONS

Nordstrom "Odyssey React Running Shoe", <<https://shop.nordstrom.com/s/nike-odyssey-react-running-shoe-women/5153952?origin=keywordsearch-personalizedsort&breadcrumb=Home%2FAll%20Results&color=light%20silver%2F%20sail%2F%20mica%20green>>, accessed Nov. 29, 2018.

* cited by examiner

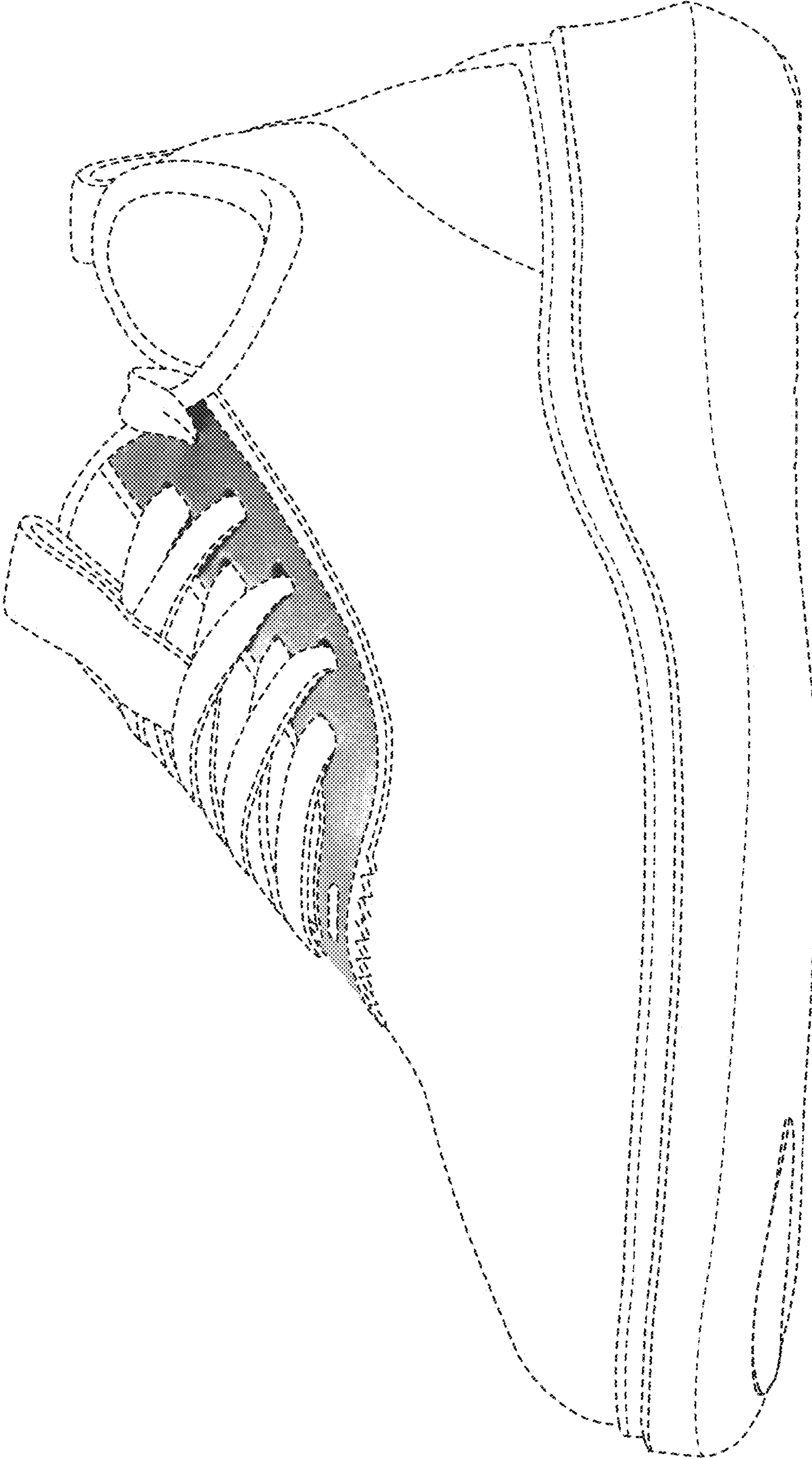

FIG. 1

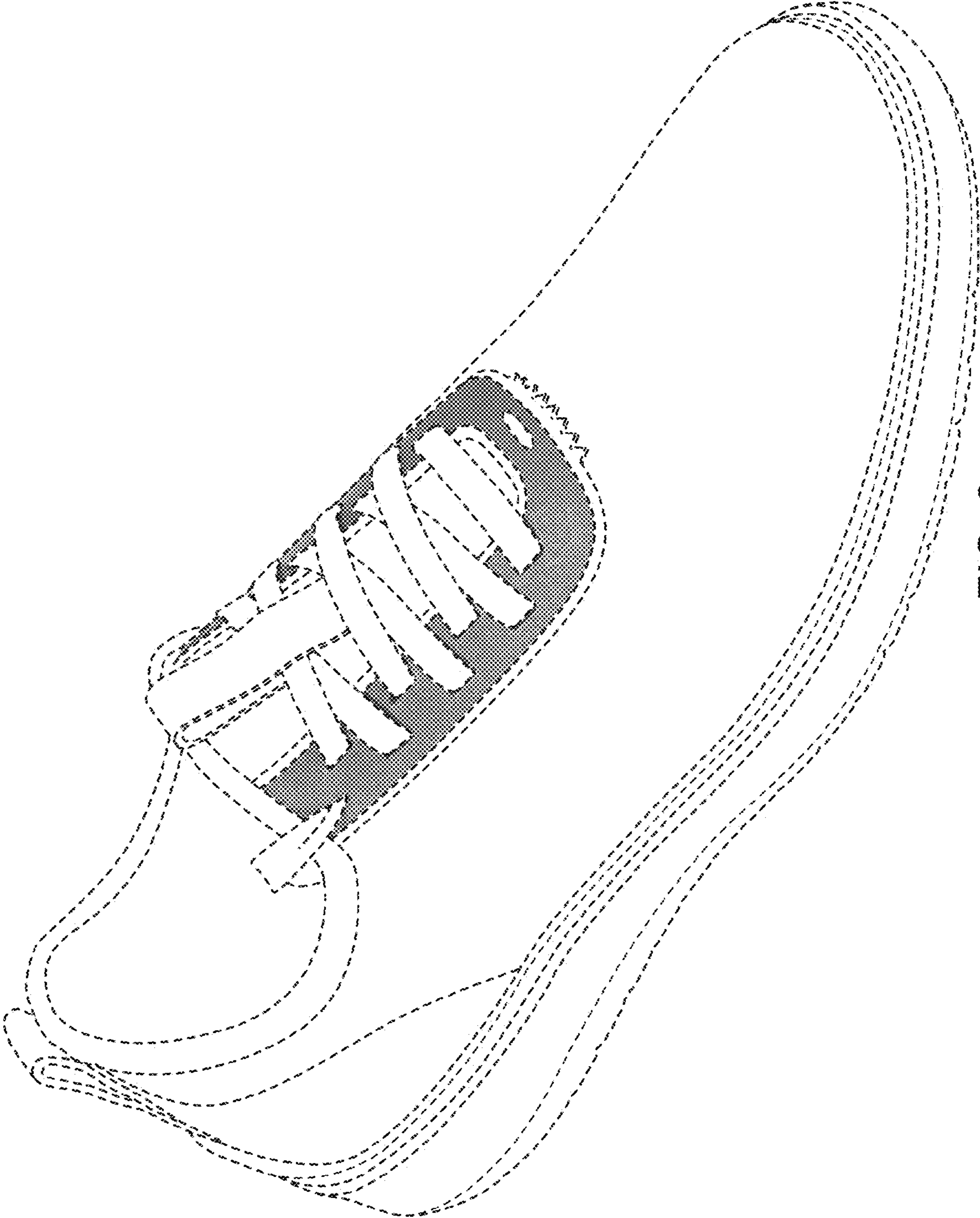

FIG. 2

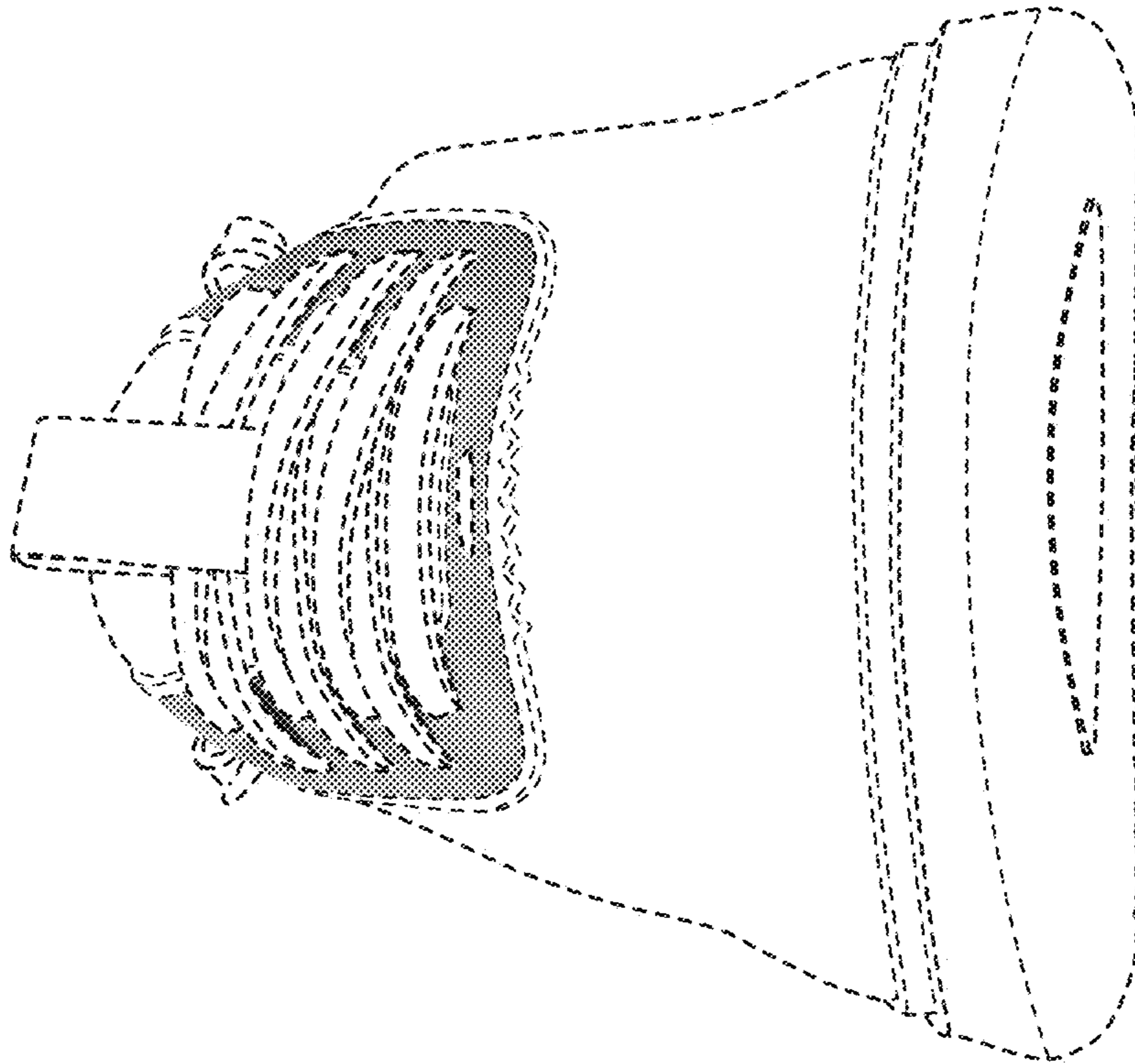

FIG. 3

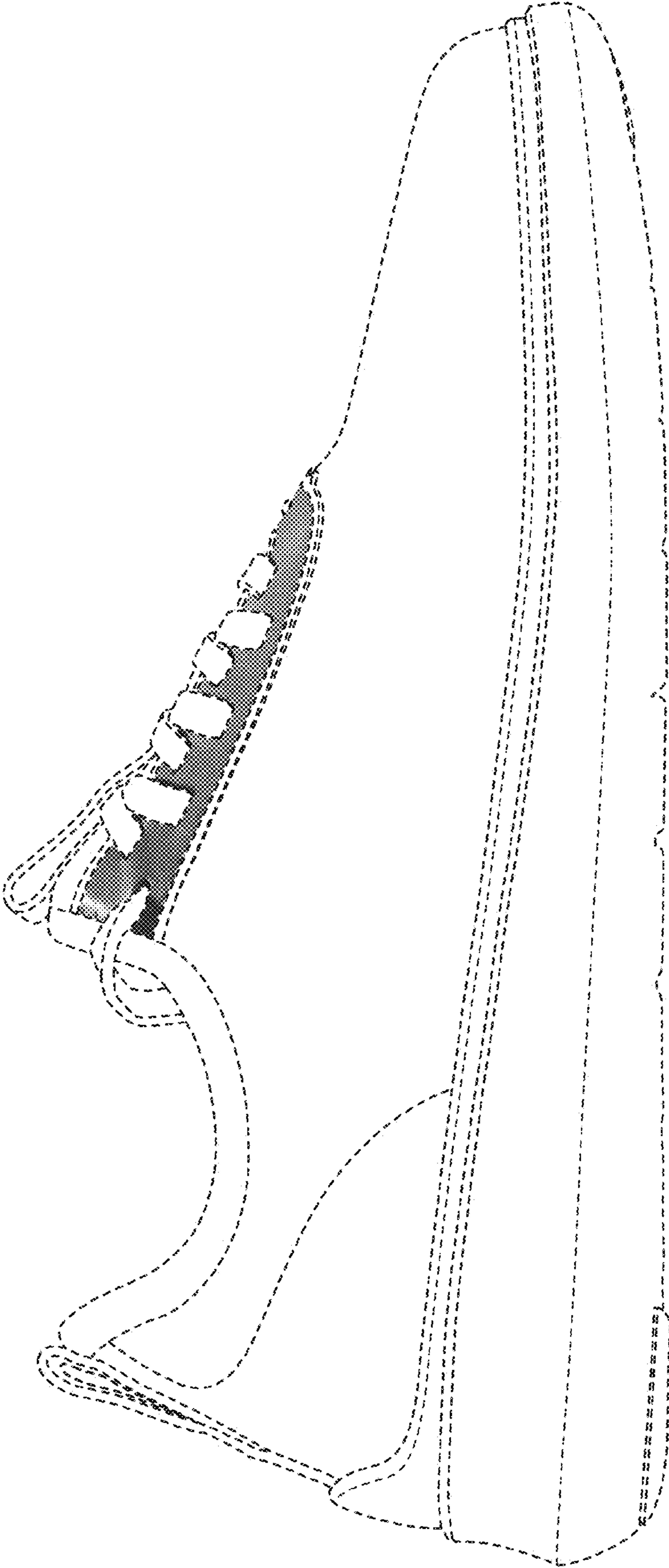

FIG. 4

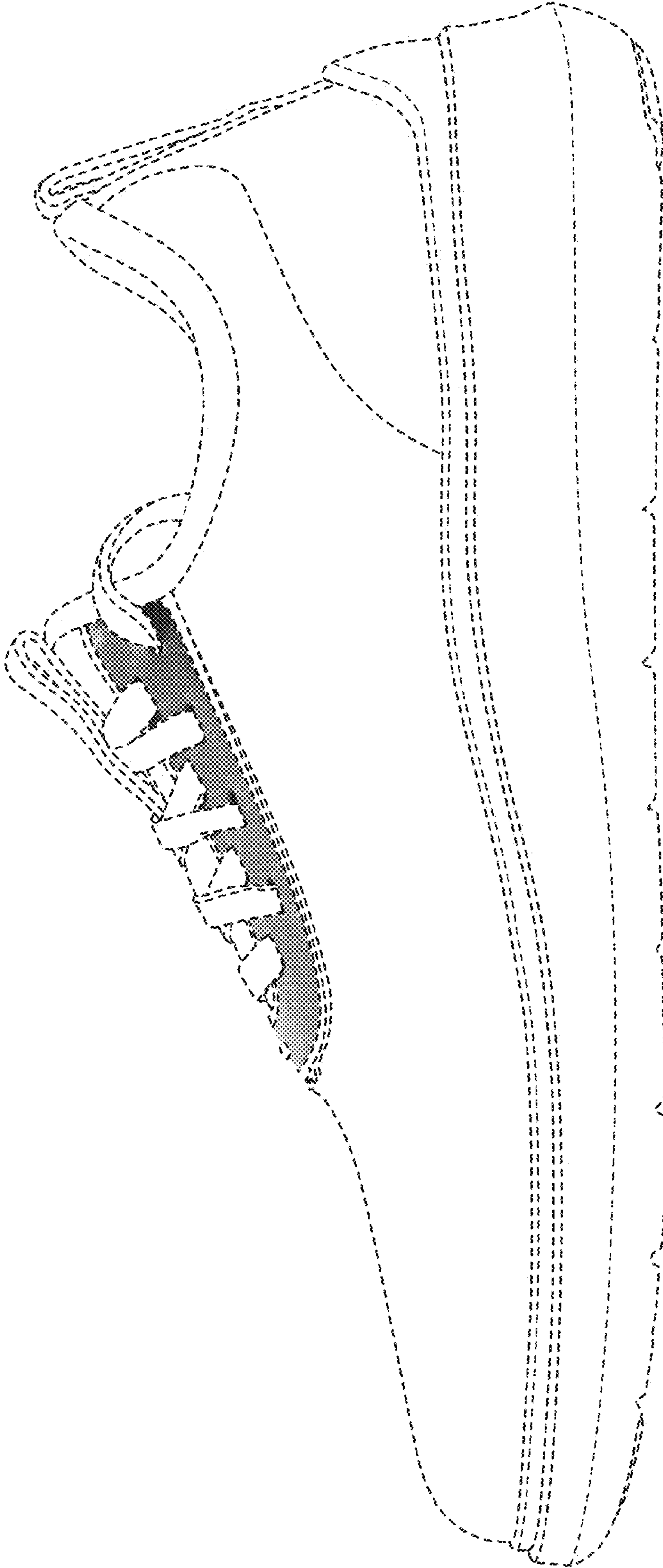

FIG. 5

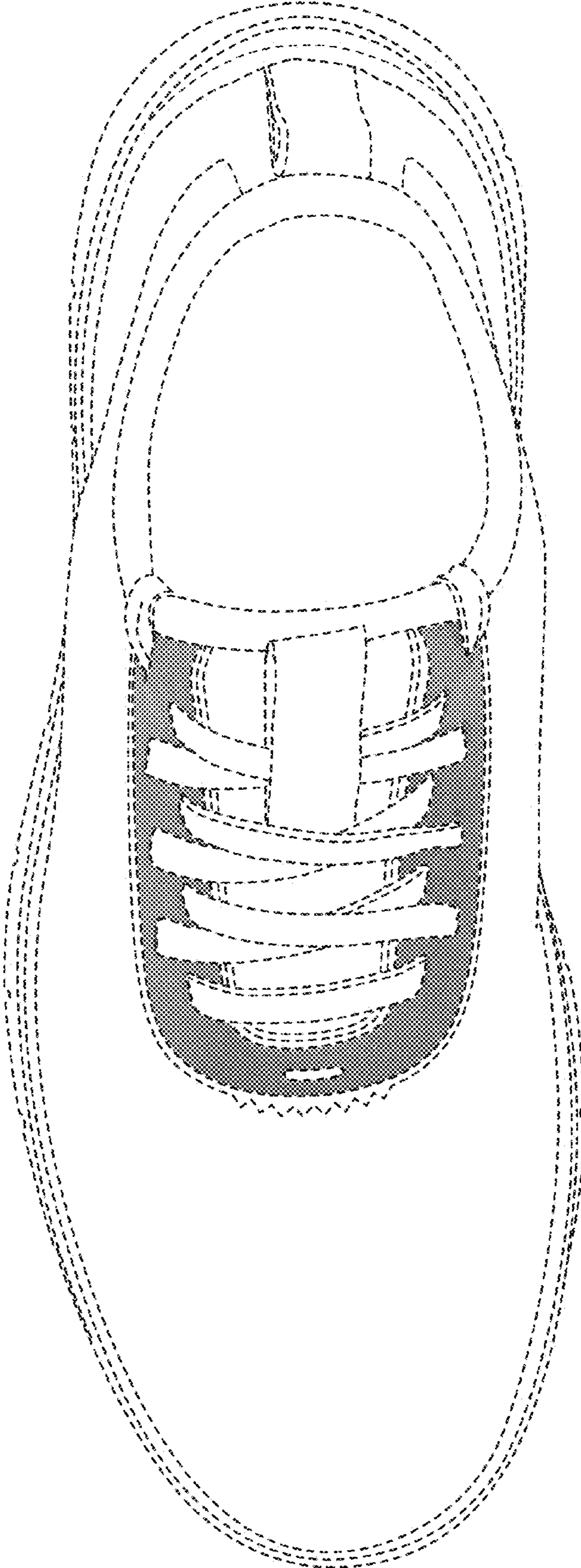

FIG. 6