



US00D914344S

(12) **United States Design Patent**
Andrew

(10) **Patent No.:** **US D914,344 S**
(45) **Date of Patent:** **** Mar. 30, 2021**

(54) **HEEL**
(71) Applicant: **Salvatore Ferragamo S.p.A.**, Florence (IT)
(72) Inventor: **Paul Andrew**, New York, NY (US)
(73) Assignee: **SALVATORE FERRAGAMO S.P.A.**, Florence (IT)
(**) Term: **15 Years**

D216,665 S * 3/1970 Barbaresi D2/965
D240,282 S * 6/1976 Horowitz et al. D2/965
4,245,407 A * 1/1981 Mazabras A43B 23/227
36/11.5
D262,329 S * 12/1981 Mazabras D2/965
D495,481 S * 9/2004 Cohen D2/964
D605,840 S * 12/2009 Schwartz D2/965
D738,603 S * 9/2015 Blair D2/965
D768,972 S * 10/2016 Gadson D2/964
D840,655 S * 2/2019 Castillo D2/965
10,485,300 B2 * 11/2019 Flowers A43B 23/28

* cited by examiner

(21) Appl. No.: **35/508,525**
(22) Filed: **Aug. 6, 2019**

Primary Examiner — Jennifer L Watkins
(74) *Attorney, Agent, or Firm* — Lucas & Mercanti, LLP

(80) **Hague Agreement Data**
Int. Filing Date: **Aug. 6, 2019**
Int. Reg. No.: **DM/203486**
Int. Reg. Date: **Aug. 6, 2019**
Int. Reg. Pub. Date: **Feb. 7, 2020**

(57) **CLAIM**

The ornamental design for heels, as shown and described.

(30) **Foreign Application Priority Data**

DESCRIPTION

Feb. 21, 2019 (EM) 006264503
(51) **LOC (13) Cl.** **02-04**
(52) **U.S. Cl.**
USPC **D2/965**
(58) **Field of Classification Search**
USPC D2/896, 925, 939, 964-967
CPC A43B 15/00; A43B 3/14; A43B 5/007;
A43B 23/30; A43B 21/42; A43B 21/00;
A43B 21/22; A43B 21/32; A43B 21/26
See application file for complete search history.

- 1.-2. Heel
- 1.1 : Perspective
- 1.2 : Perspective
- 1.3 : Front
- 1.4 : Back
- 1.5 : Left
- 1.6 : Top
- 1.7 : Bottom
- 2.1 : Perspective
- 2.2 : Perspective
- 2.3 : Front
- 2.4 : Back
- 2.5 : Left
- 2.6 : Top
- 2.7 : Bottom

(56) **References Cited**
U.S. PATENT DOCUMENTS

D123,167 S * 10/1940 Nutt D2/966
D216,663 S * 3/1970 Barbaresi D2/965

1 Claim, 14 Drawing Sheets

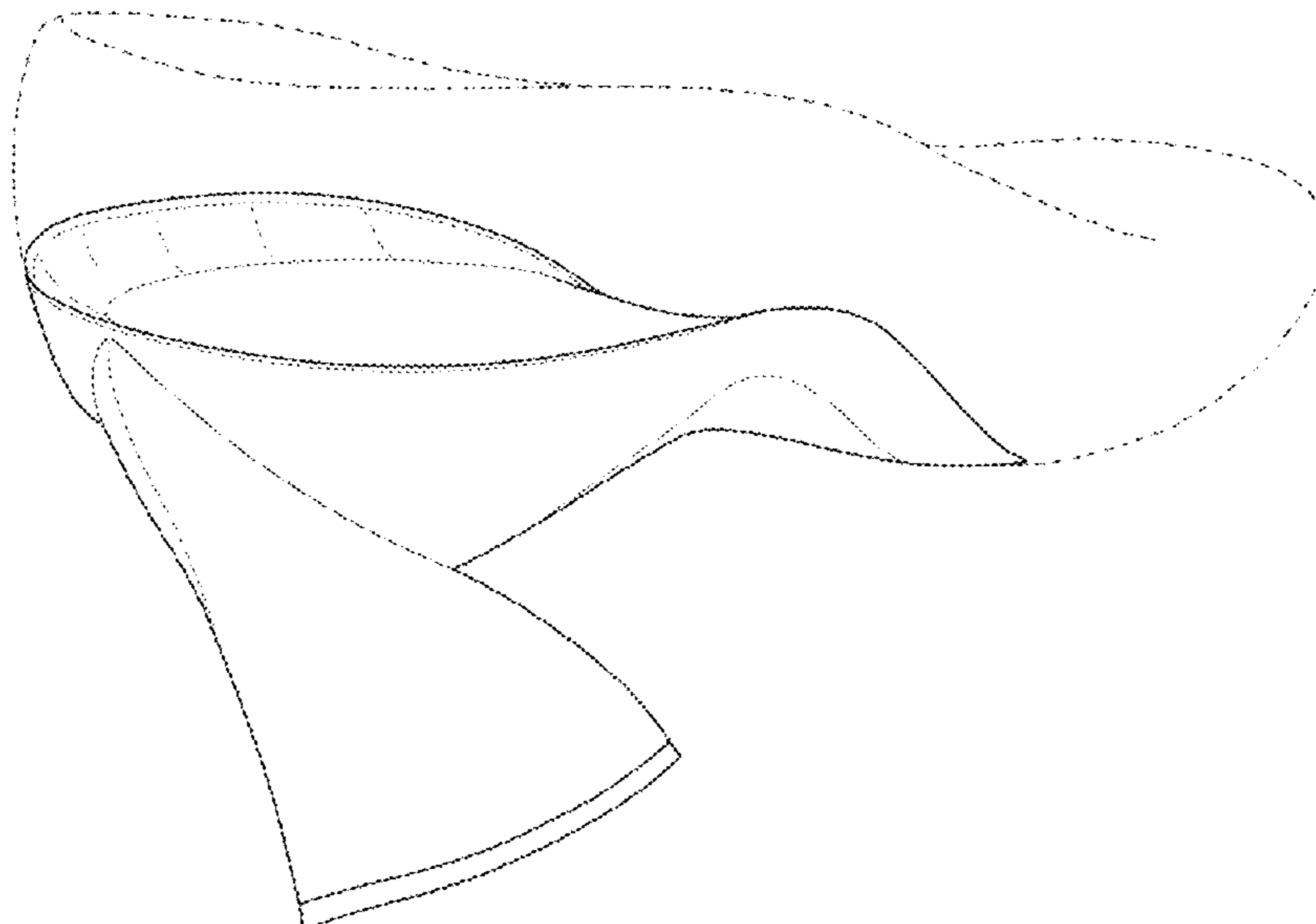

1.1

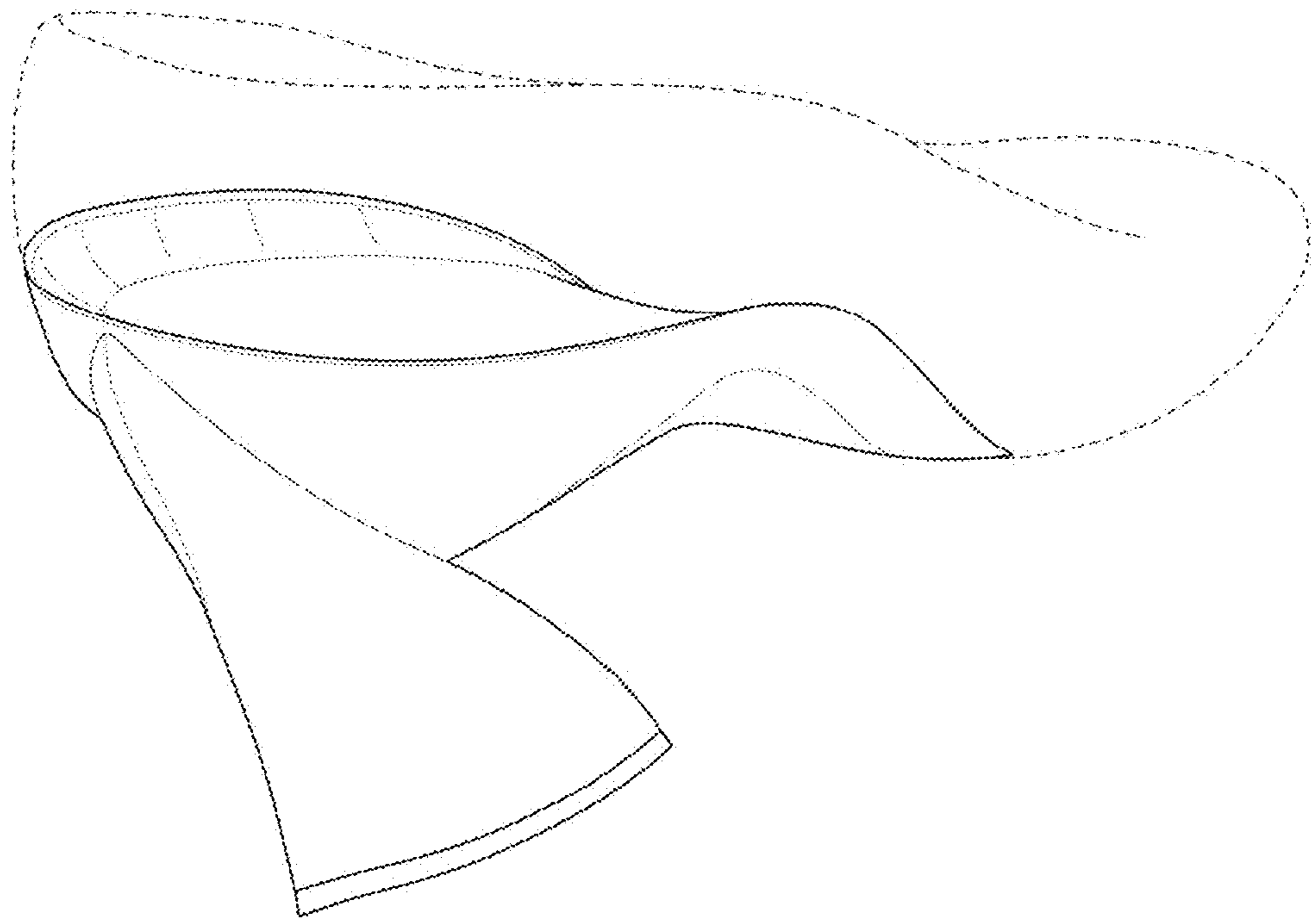

1.2

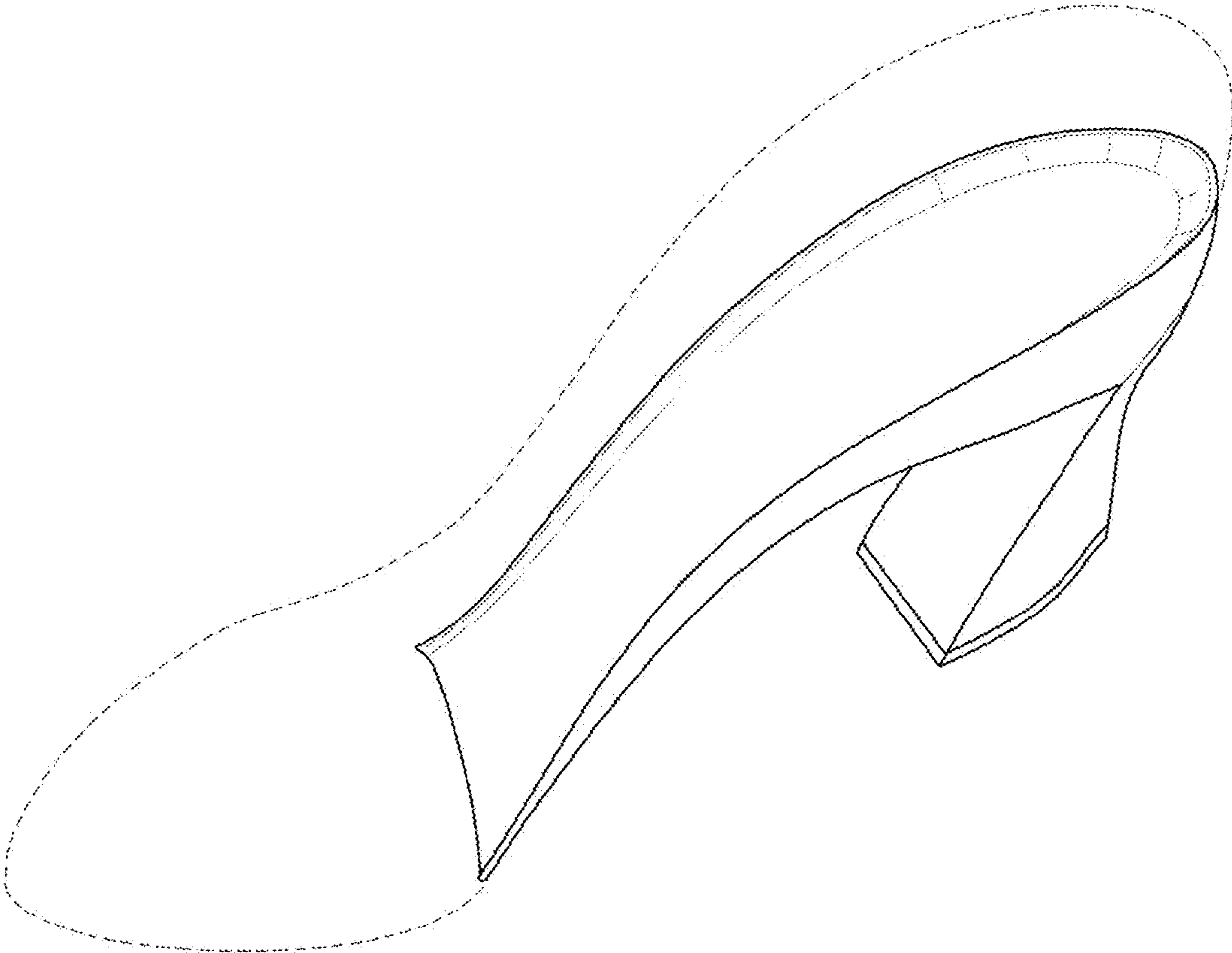

1.3

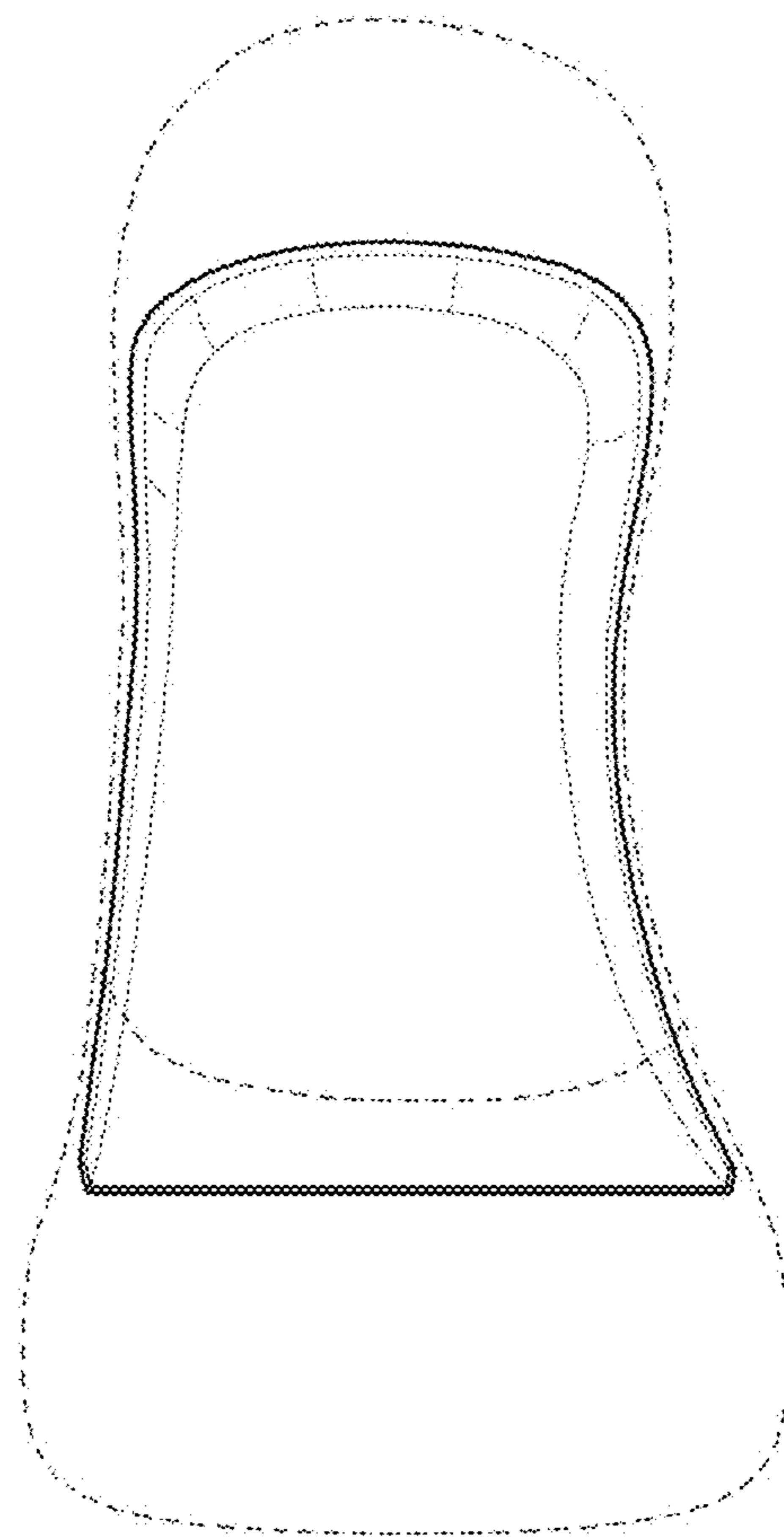

1.4

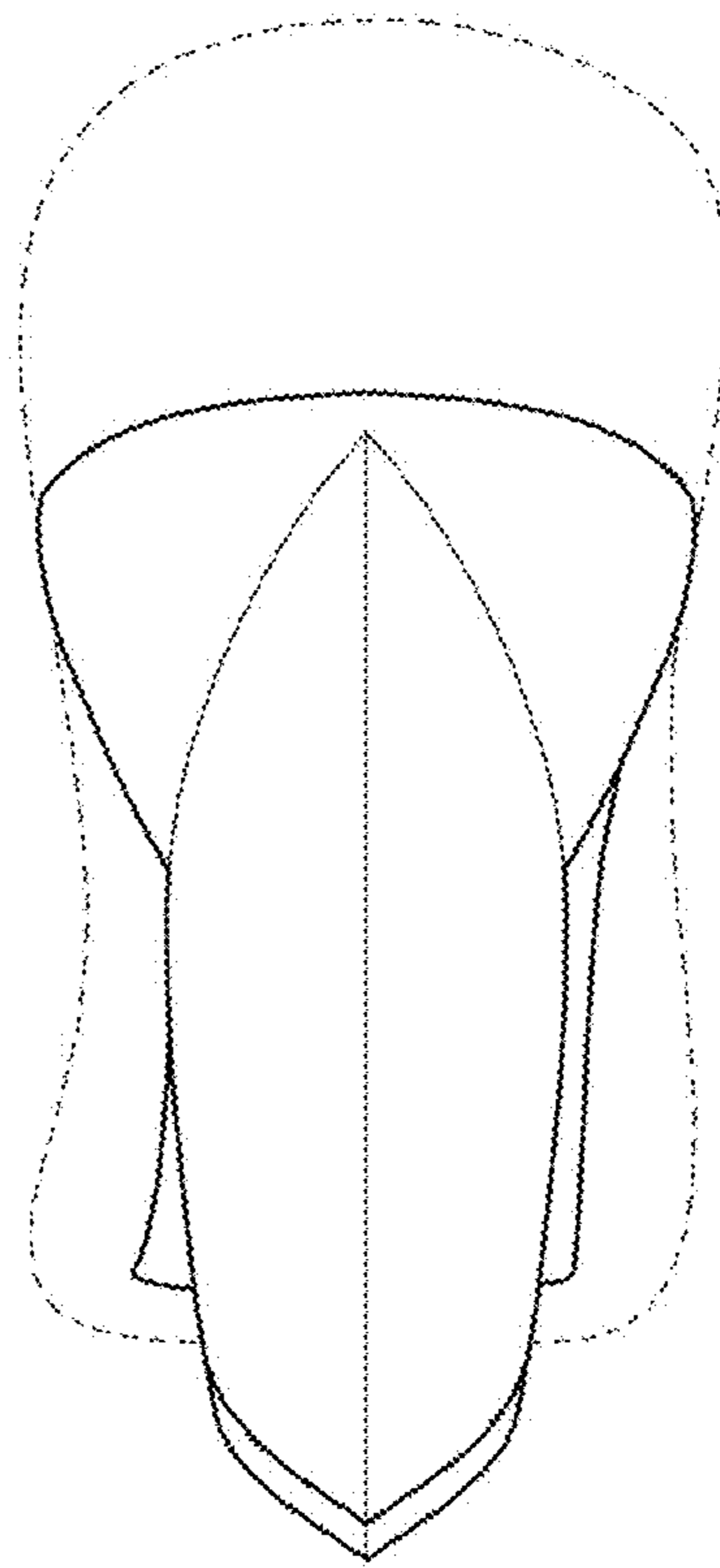

1.5

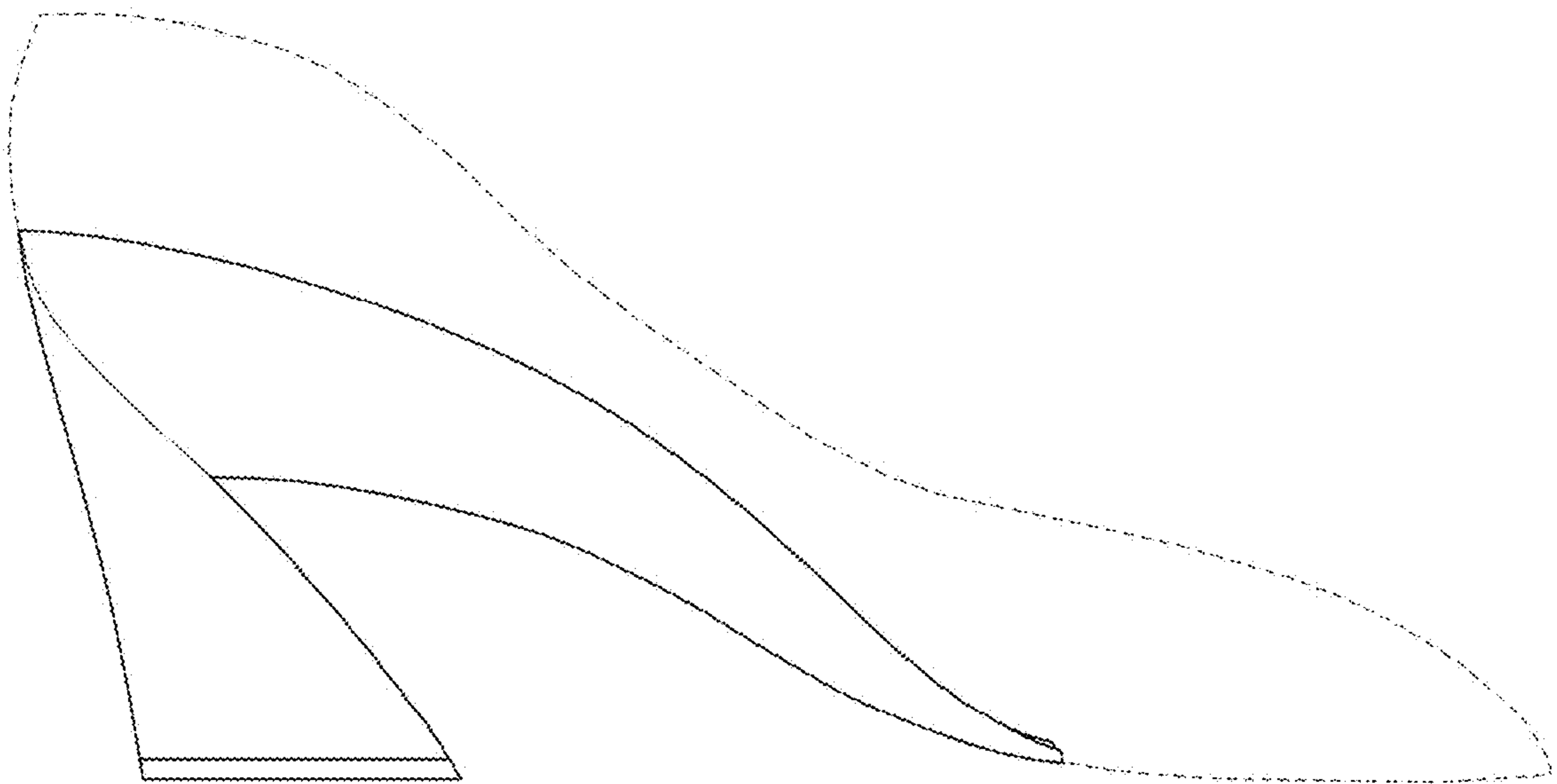

1.6

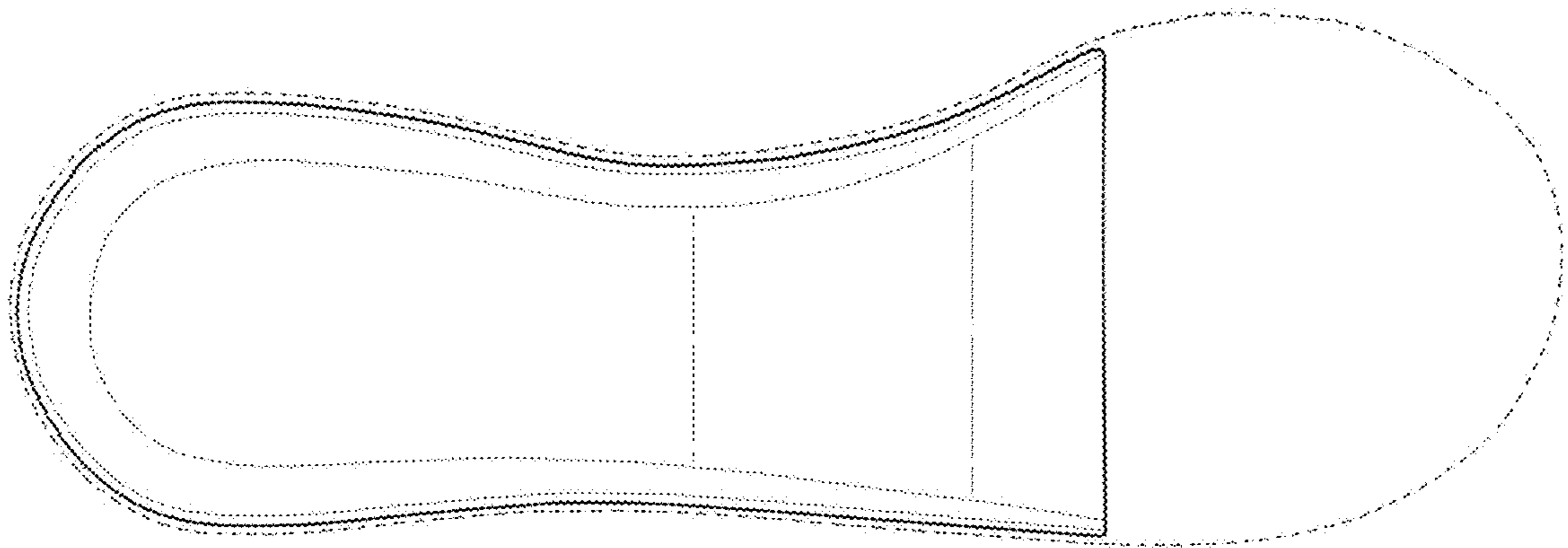

1.7

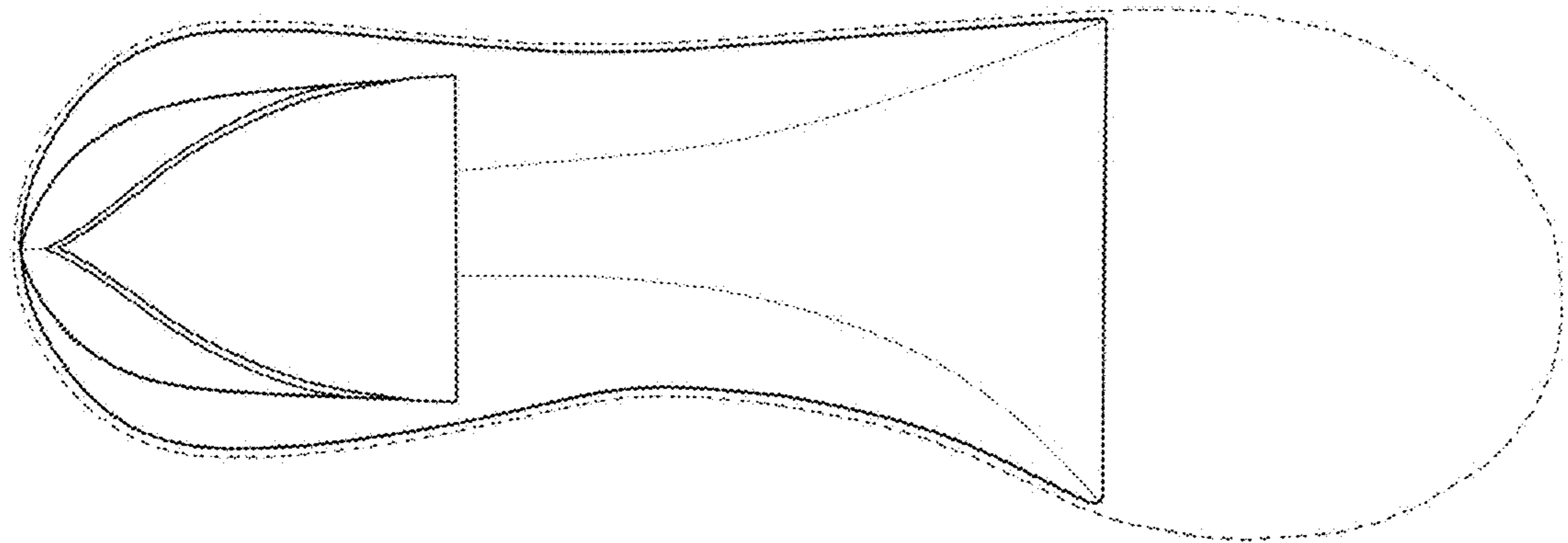

2.1

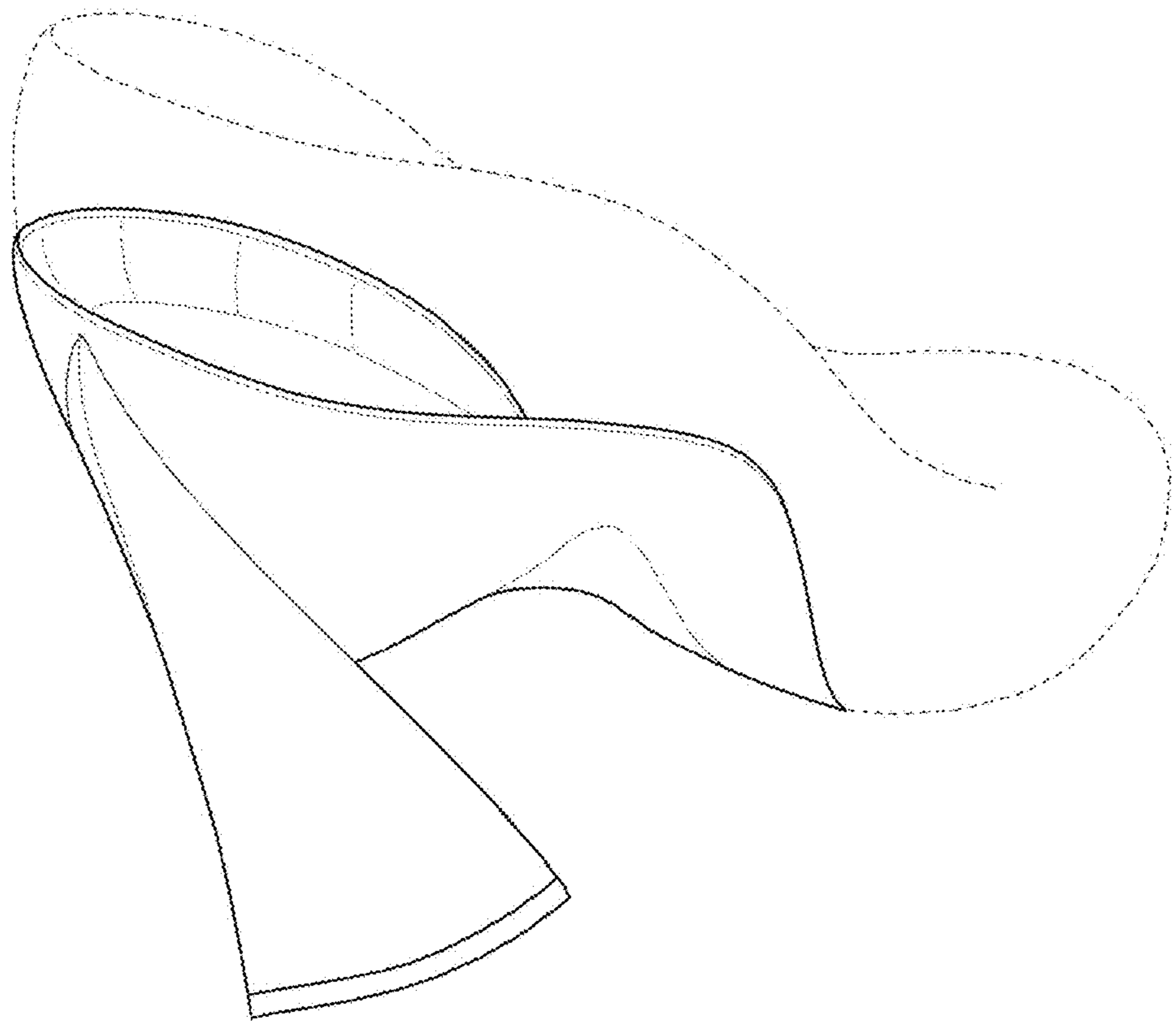

2.2

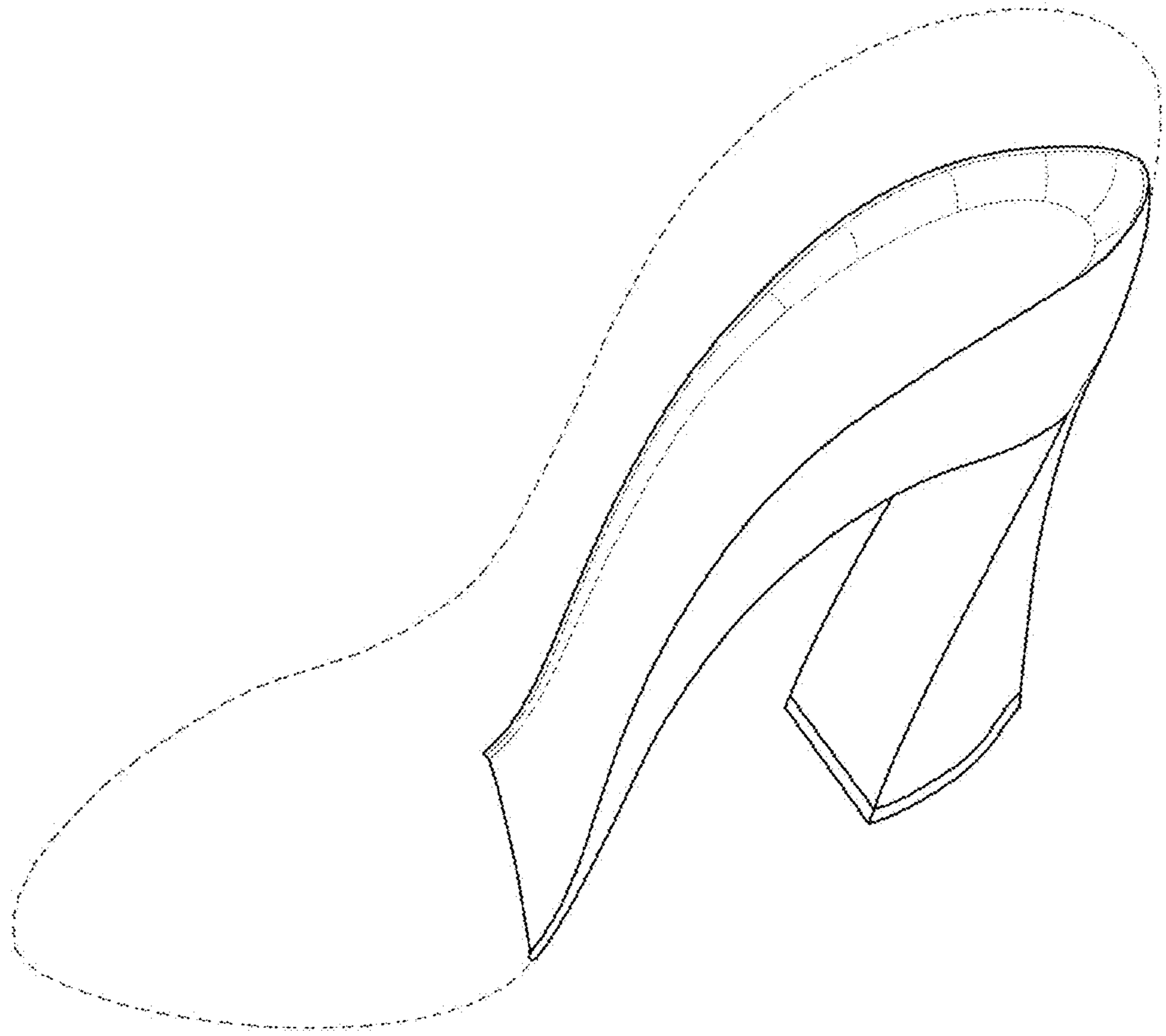

2.3

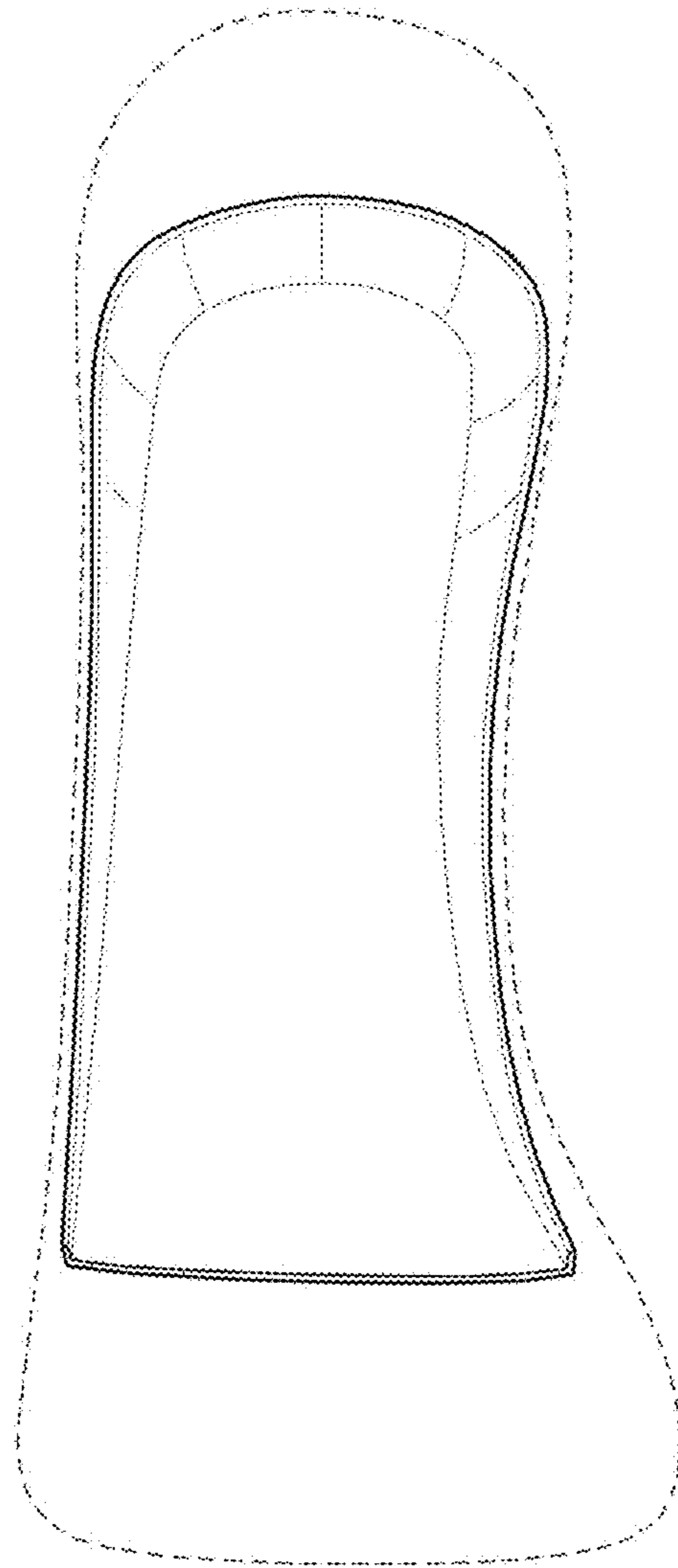

2.4

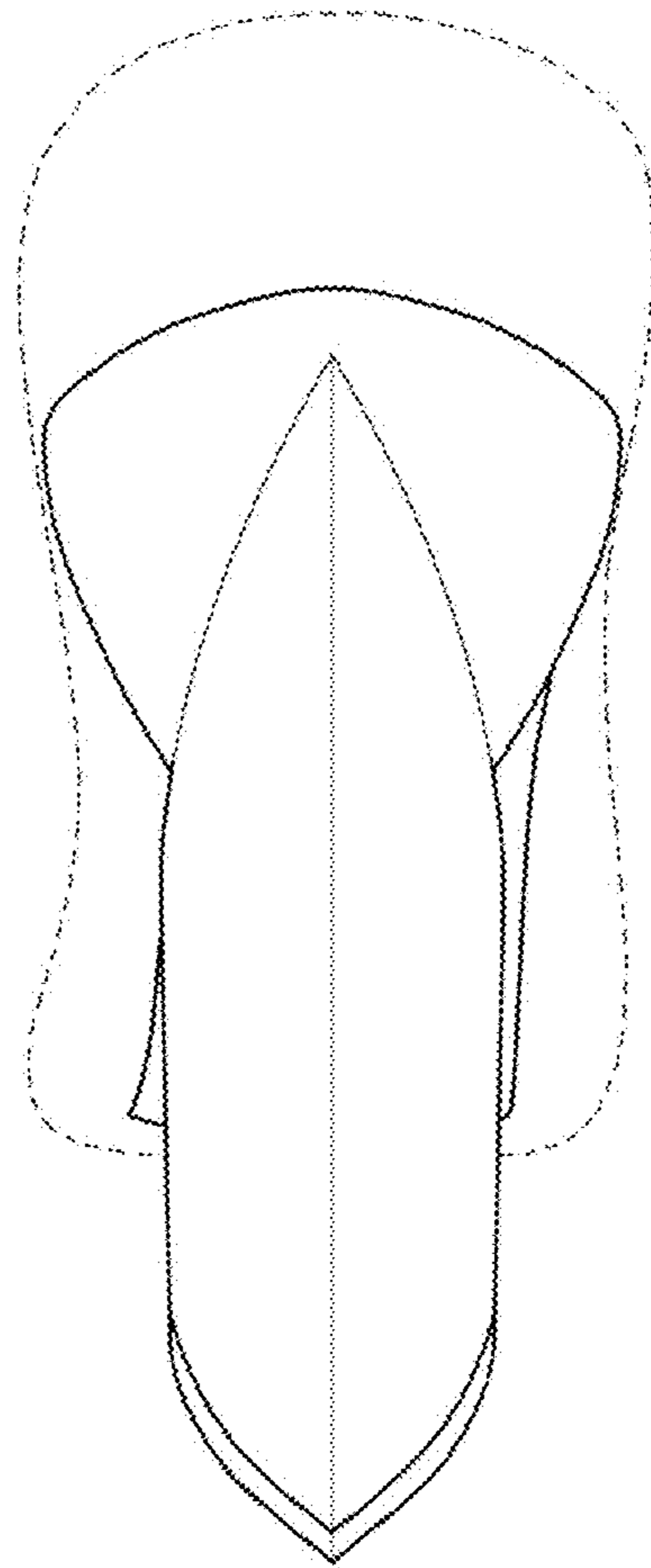

2.5

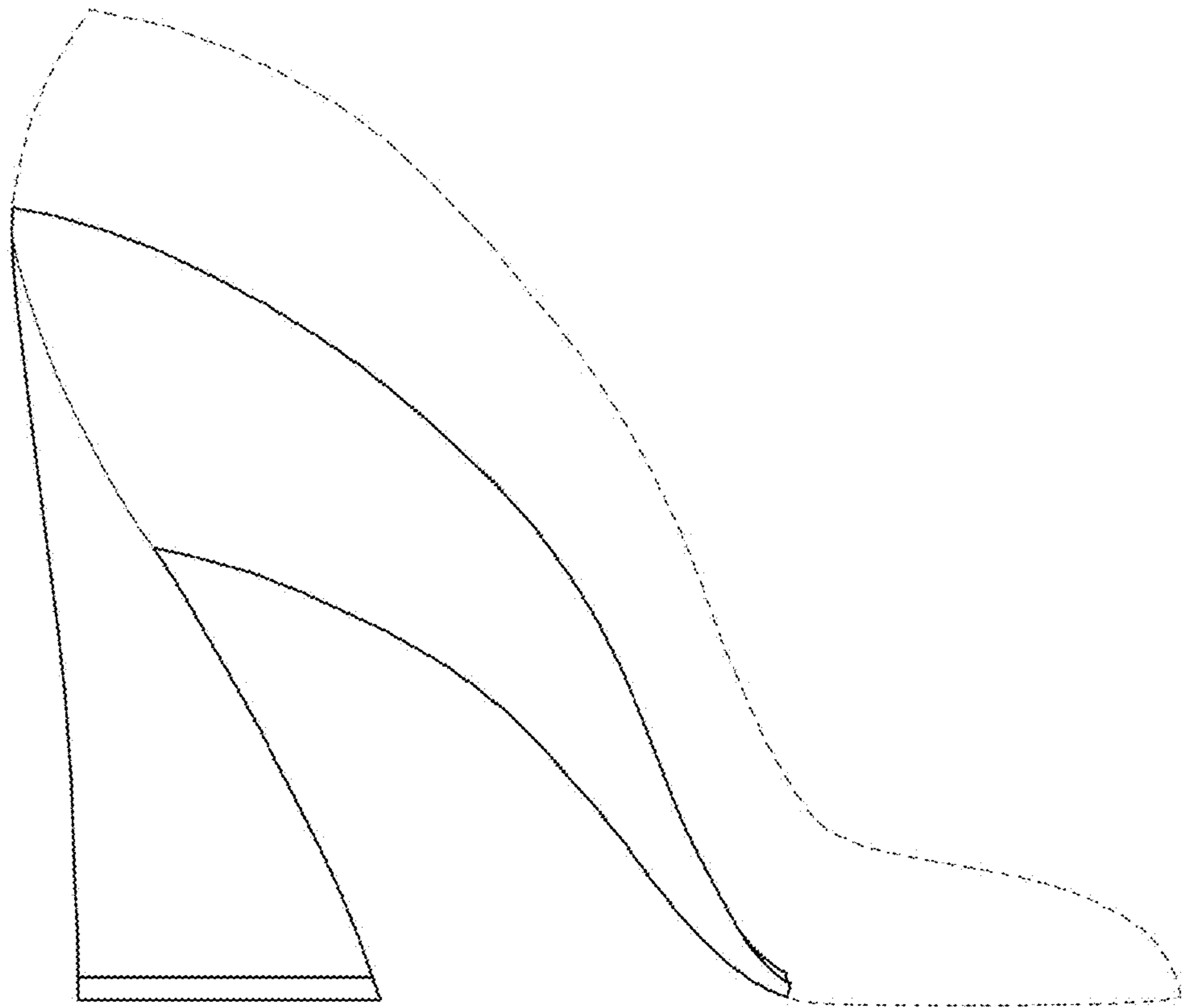

2.6

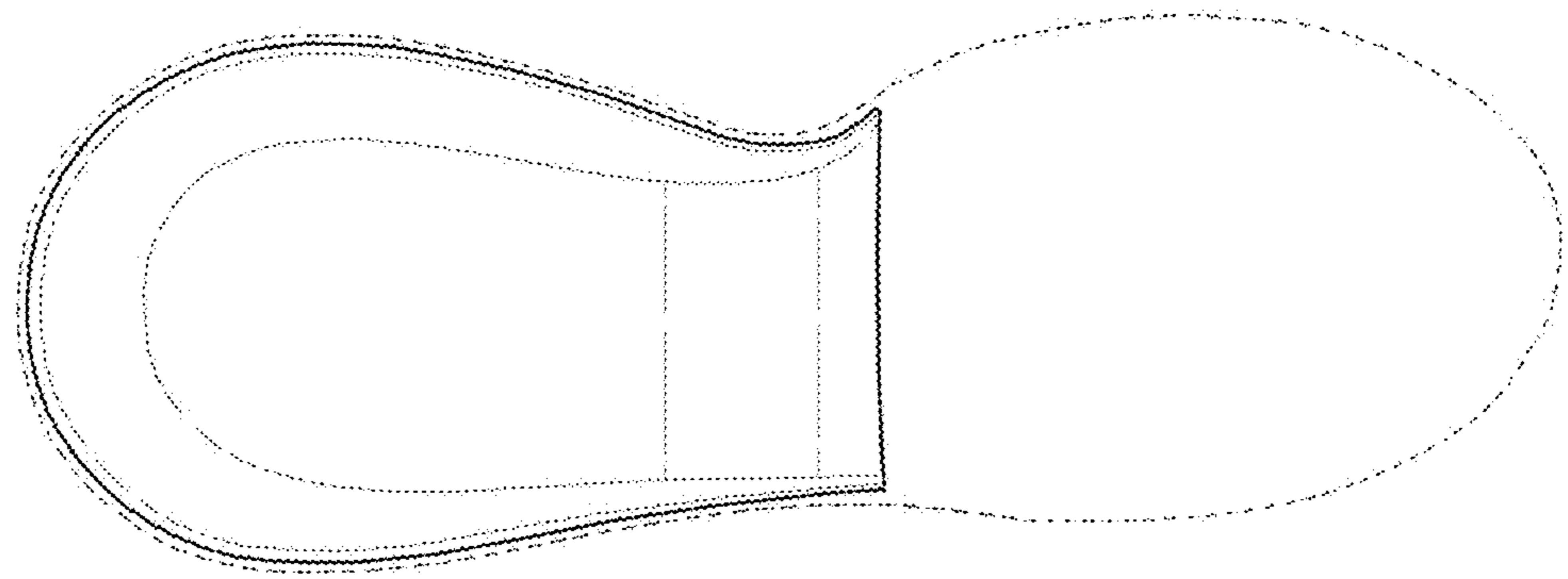

2.7

