



US00D914156S

(12) **United States Design Patent**
Zhu

(10) **Patent No.:** **US D914,156 S**

(45) **Date of Patent:** **** *Mar. 23, 2021**

(54) **FAUCET BODY**

(71) Applicant: **Hansgrohe SE**, Schiltach (DE)

(72) Inventor: **Chuanbao Zhu**, Fujian (CN)

(73) Assignee: **Hansgrohe SE**, Schiltach (DE)

(*) Notice: This patent is subject to a terminal disclaimer.

(**) Term: **15 Years**

(21) Appl. No.: **29/700,661**

(22) Filed: **Aug. 5, 2019**

(30) **Foreign Application Priority Data**

Feb. 20, 2019 (EM) 006262440-0006

(51) **LOC (13) Cl.** **23-01**

(52) **U.S. Cl.**
USPC **D23/249; D23/255**

(58) **Field of Classification Search**
USPC D23/238, 239, 240, 241, 242, 243, 249,
D23/255, 256, 257; D6/524
CPC E03C 1/04; E03C 1/0401; E03C 1/0402;
E03C 1/0404; E03C 1/0405; E03C
1/0412; Y10T 137/9464
See application file for complete search history.

(56) **References Cited**

U.S. PATENT DOCUMENTS

D487,922 S * 3/2004 Lord D23/249
D580,017 S * 11/2008 Yegyayan D23/238

D594,533 S * 6/2009 Schoenherr D23/238
D625,780 S * 10/2010 Soriano D23/255
D761,392 S * 7/2016 Hanna D23/255
D800,260 S * 10/2017 Fritz D23/238
D810,882 S * 2/2018 Bahler D23/249
D858,714 S * 9/2019 Garland D23/249
D865,130 S * 10/2019 Eads D23/249
D873,385 S * 1/2020 Tentler D23/257

* cited by examiner

Primary Examiner — John A Voytek

(74) *Attorney, Agent, or Firm* — Lora J. Graentzdoerffer

(57) **CLAIM**

The ornamental design for a faucet body, as shown and described.

DESCRIPTION

FIG. 1 is a perspective view of a faucet body showing my design;
FIG. 2 is a front elevation view;
FIG. 3 is a rear elevation view;
FIG. 4 is a right side elevation view;
FIG. 5 is a left side elevation view;
FIG. 6 is a top plan view; and,
FIG. 7 is a bottom plan view.
The broken-line disclosures in the drawings represent portions of the faucet body that form no part of the claimed design.

1 Claim, 7 Drawing Sheets

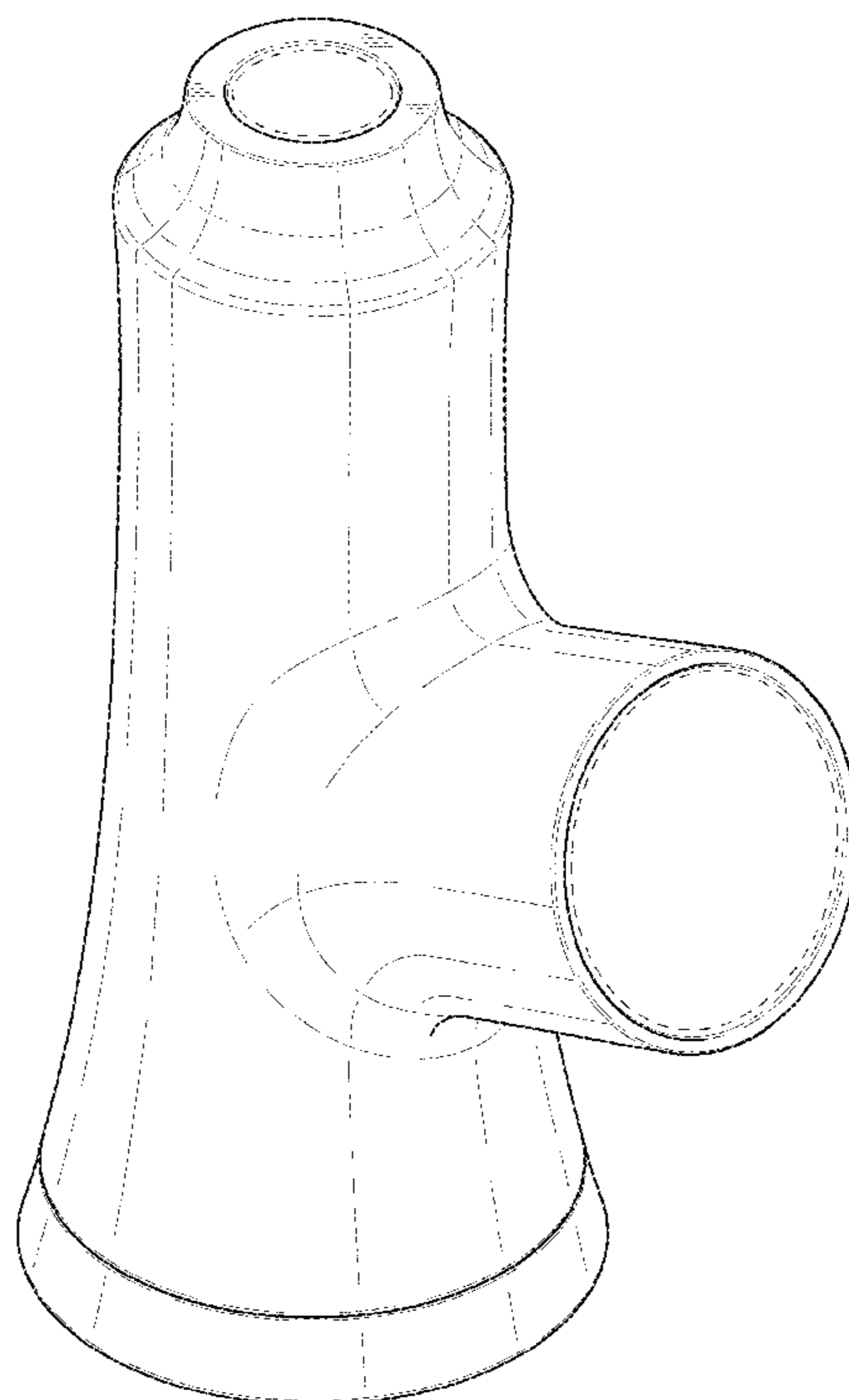

FIG. 1

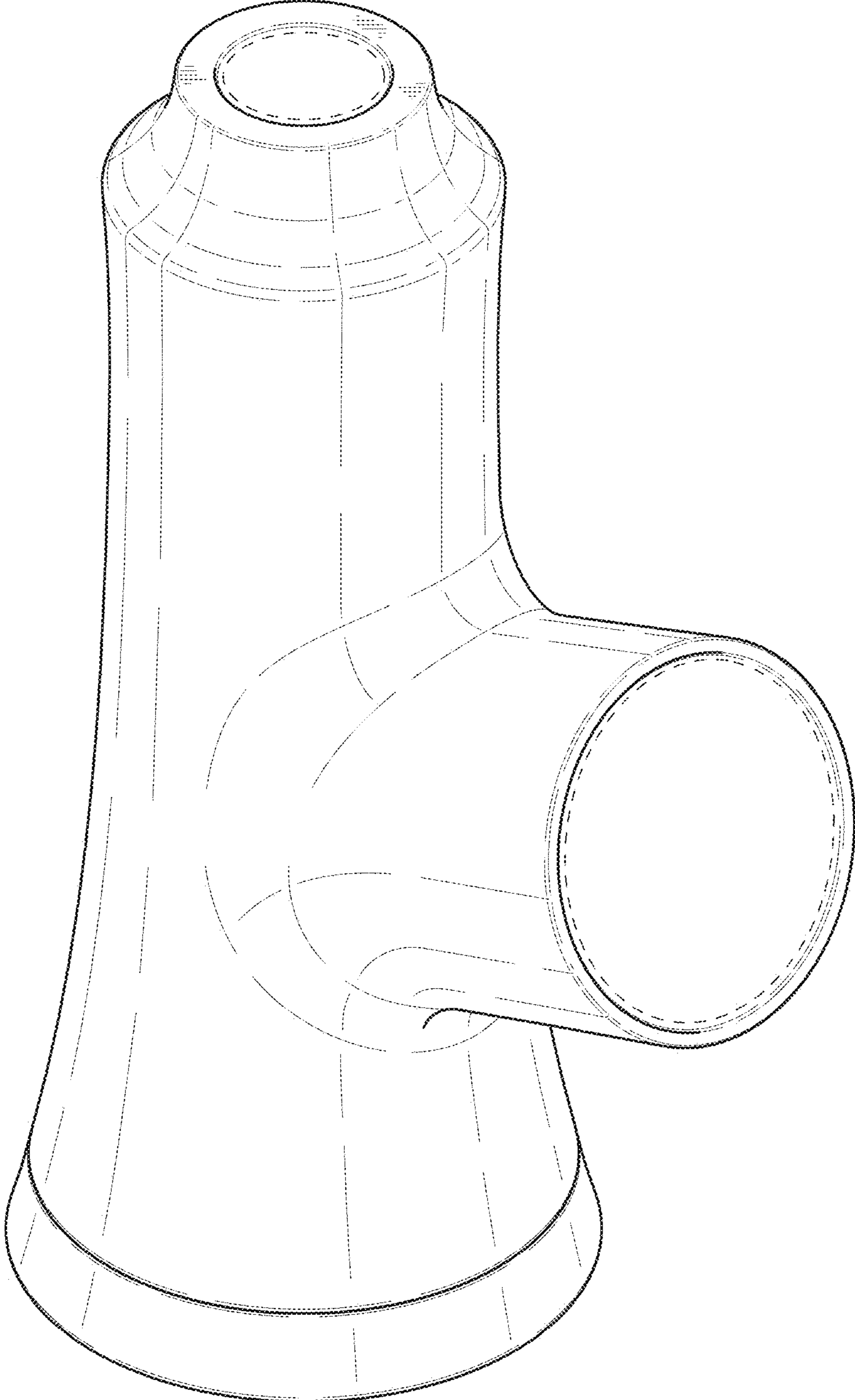

FIG. 2

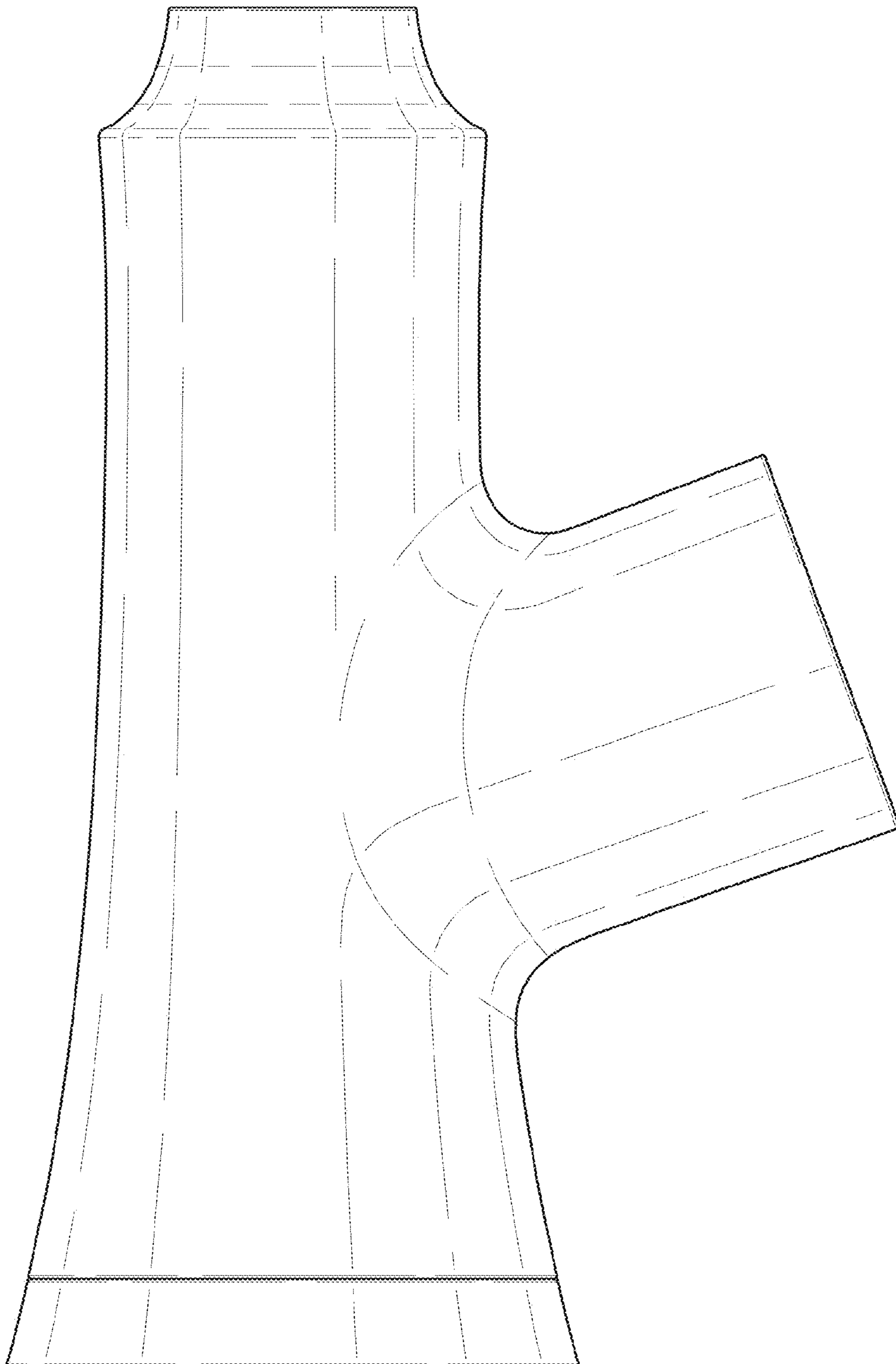

FIG. 3

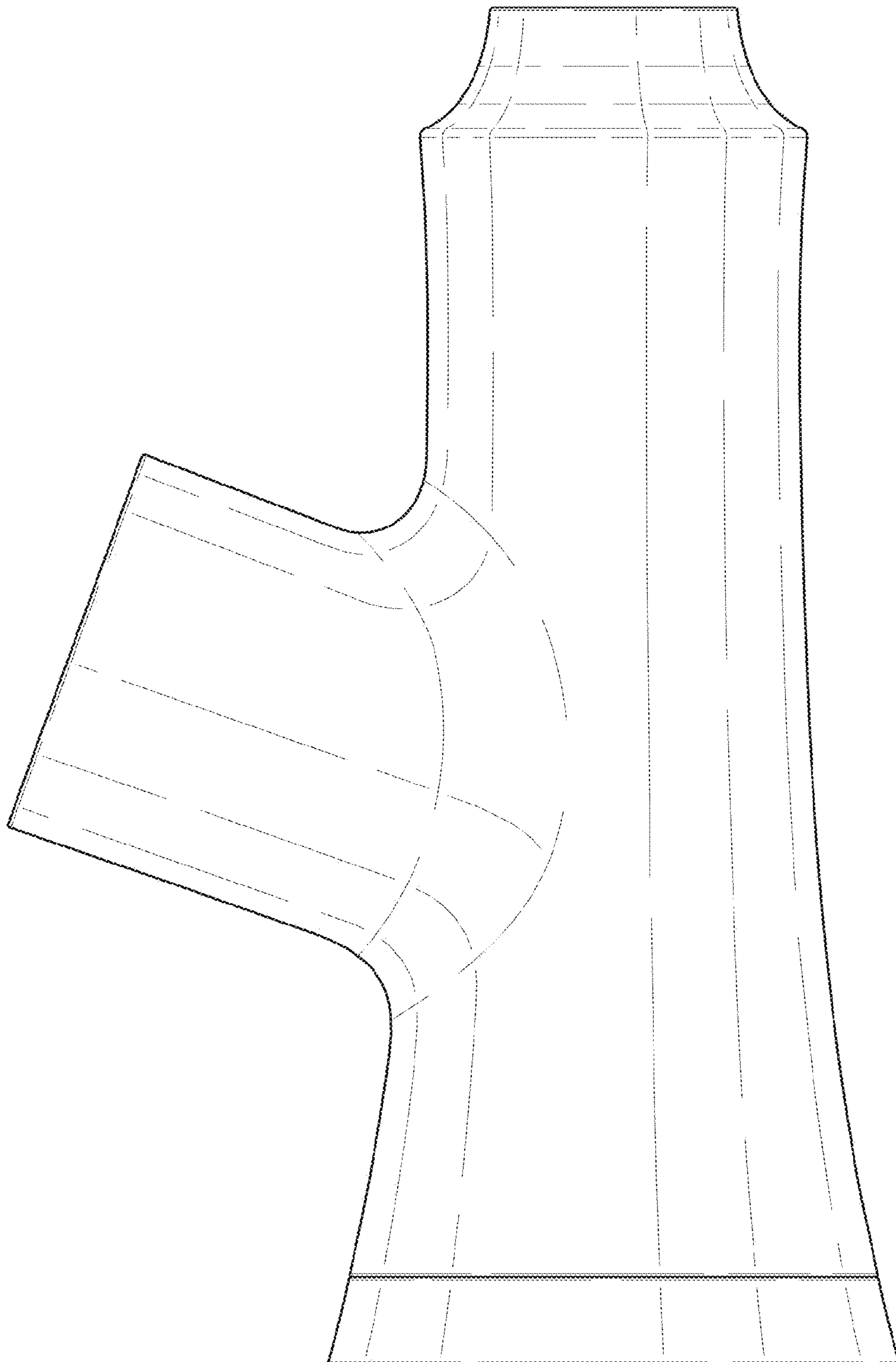

FIG. 4

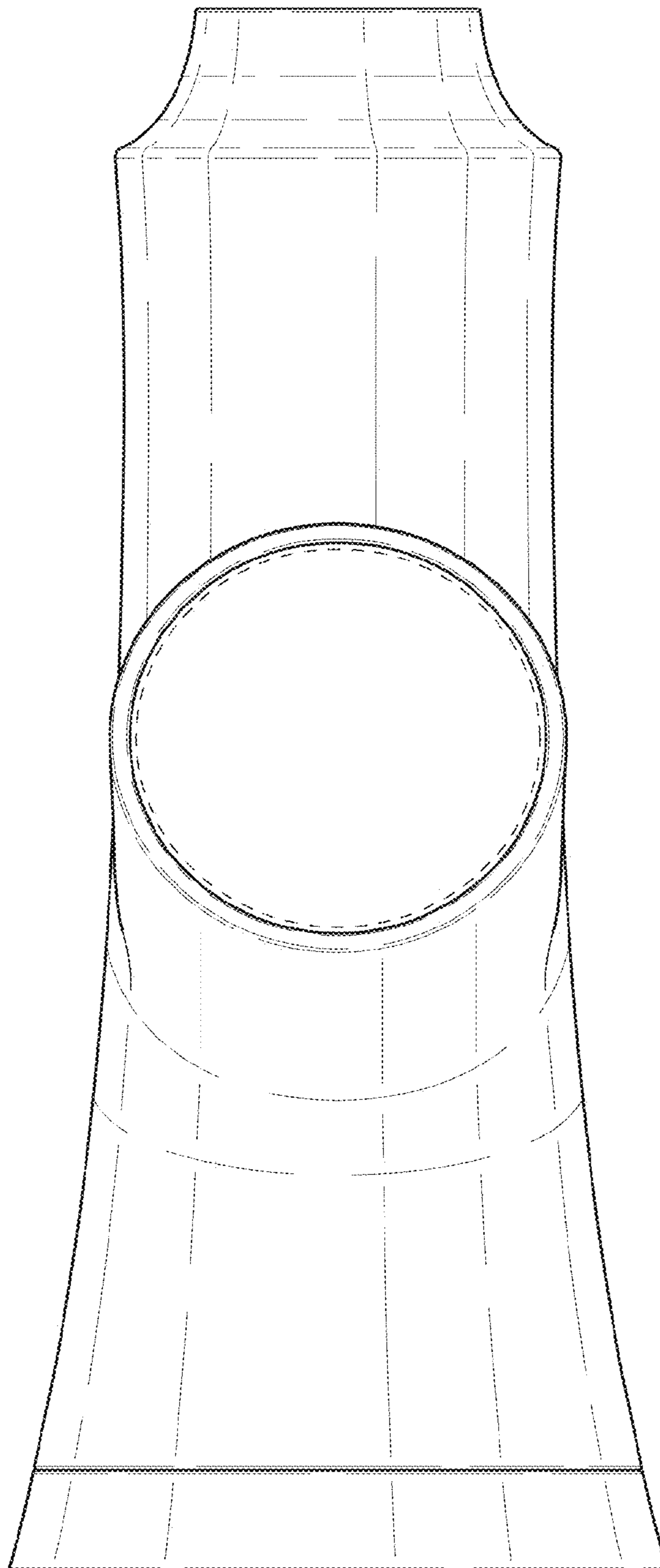

FIG. 5

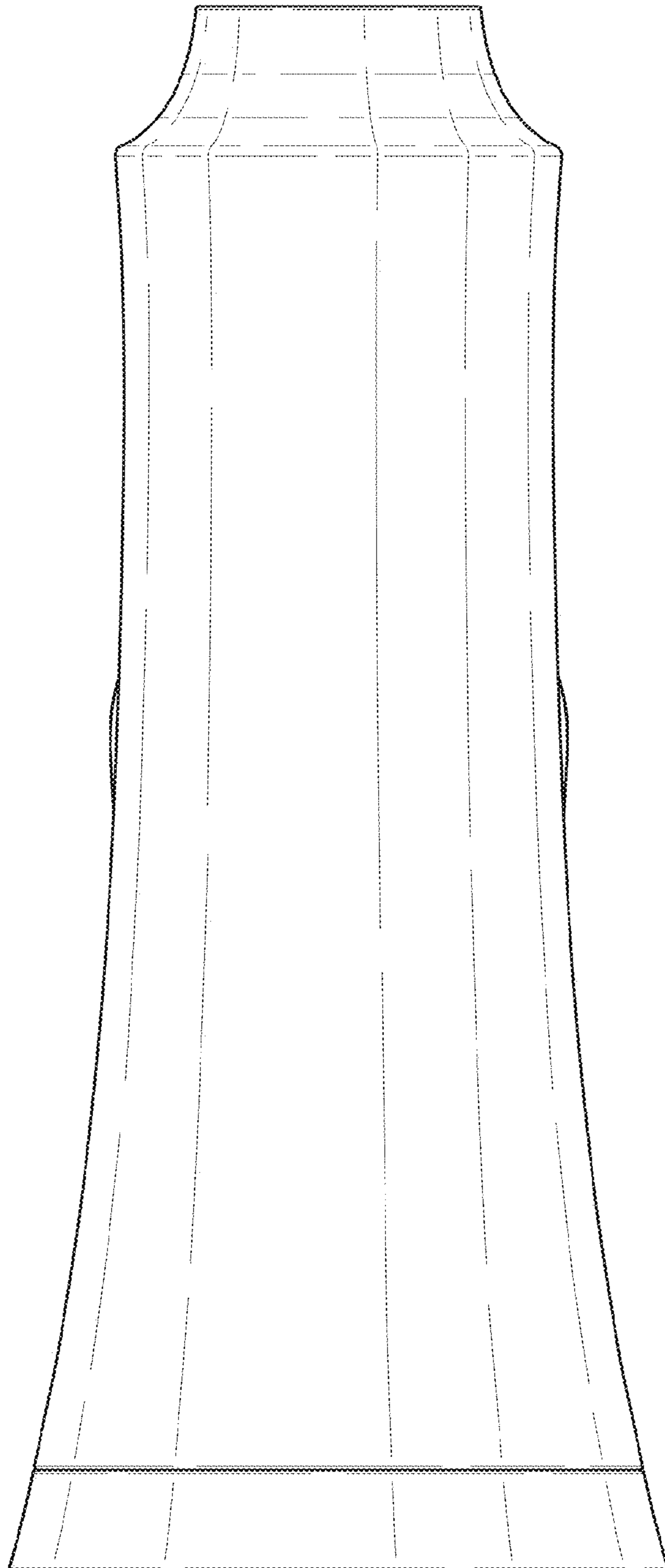

FIG. 6

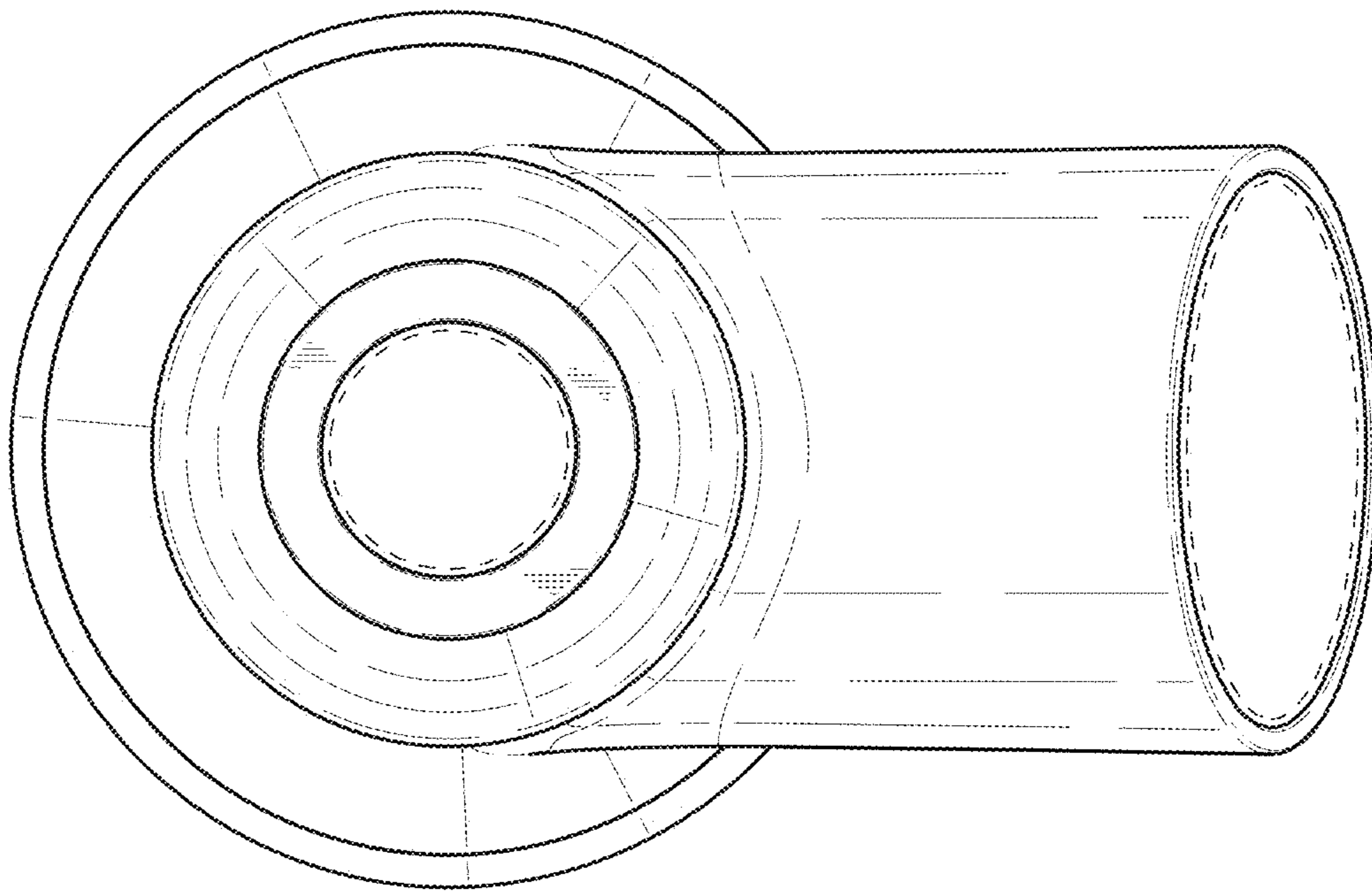

FIG. 7

