



US00D914148S

(12) **United States Design Patent**  
**Flaig et al.**

(10) **Patent No.:** **US D914,148 S**

(45) **Date of Patent:** **\*\* Mar. 23, 2021**

(54) **FAUCET**

(71) Applicant: **Hansgrohe SE**, Schiltach (DE)

(72) Inventors: **Marco Flaig**, Stuttgart (DE); **Andreas Diefenbach**, Ludwigsburg-Oßweil (DE)

(73) Assignee: **Hansgrohe SE**, Schiltach (DE)

(\*\*) Term: **15 Years**

(21) Appl. No.: **29/701,921**

(22) Filed: **Aug. 15, 2019**

(30) **Foreign Application Priority Data**

Feb. 21, 2019 (EM) ..... 006263976-0003

(51) **LOC (13) Cl.** ..... **23-01**

(52) **U.S. Cl.**  
USPC ..... **D23/238**

(58) **Field of Classification Search**  
USPC ..... D23/238, 239, 240, 241, 242, 243, 249,  
D23/250, 255, 256, 257; D6/524  
CPC ..... E03C 1/04; E03C 1/0401; E03C 1/0402;  
E03C 1/0404; E03C 1/0405; E03C  
1/0412; Y10T 137/9464

See application file for complete search history.

(56) **References Cited**

**U.S. PATENT DOCUMENTS**

D444,212 S \* 6/2001 Fleischmann ..... D23/238  
D456,878 S \* 5/2002 Gottwald ..... D23/238  
D457,939 S \* 5/2002 Gottwald ..... D23/238  
D520,605 S \* 5/2006 Gilbert ..... D23/249  
D527,076 S \* 8/2006 Kolin ..... D23/241  
D645,120 S \* 9/2011 Lammel ..... D23/238

D723,665 S \* 3/2015 Kulig ..... D23/238  
D811,527 S \* 2/2018 Fritz ..... D23/238  
D844,111 S \* 3/2019 Soulier ..... D23/238  
D855,766 S \* 8/2019 Seum ..... D23/238  
D861,833 S \* 10/2019 Fiori ..... D23/238  
D882,735 S \* 4/2020 Seum ..... D23/238  
D885,524 S \* 5/2020 Seum ..... D23/241

**OTHER PUBLICATIONS**

Hansgrohe Talis N HighArc Kitchen Faucet, O-Style 2-Spray Pull-Down [Sep. 10, 2020] found online [Sep. 10, 2020]—<https://www.hansgrohe-usa.com/articledetail-talis-n-higharc-kitchen-faucet-o-style-2-spray-pull-down-1-75-gpm-72800001>.\*

\* cited by examiner

*Primary Examiner* — John A Voytek

(74) *Attorney, Agent, or Firm* — Lora J. Graentzdoerffer

(57) **CLAIM**

The ornamental design for a faucet, as shown and described.

**DESCRIPTION**

FIG. 1 is a perspective view of a faucet showing our design; FIG. 2 is a front elevation view; FIG. 3 is a rear elevation view; FIG. 4 is a right side elevation view; FIG. 5 is a left side elevation view; FIG. 6 is a top plan view; and, FIG. 7 is a bottom plan view.

The broken-line disclosures in the drawings represent portions of the faucet that form no part of the claimed design.

**1 Claim, 7 Drawing Sheets**

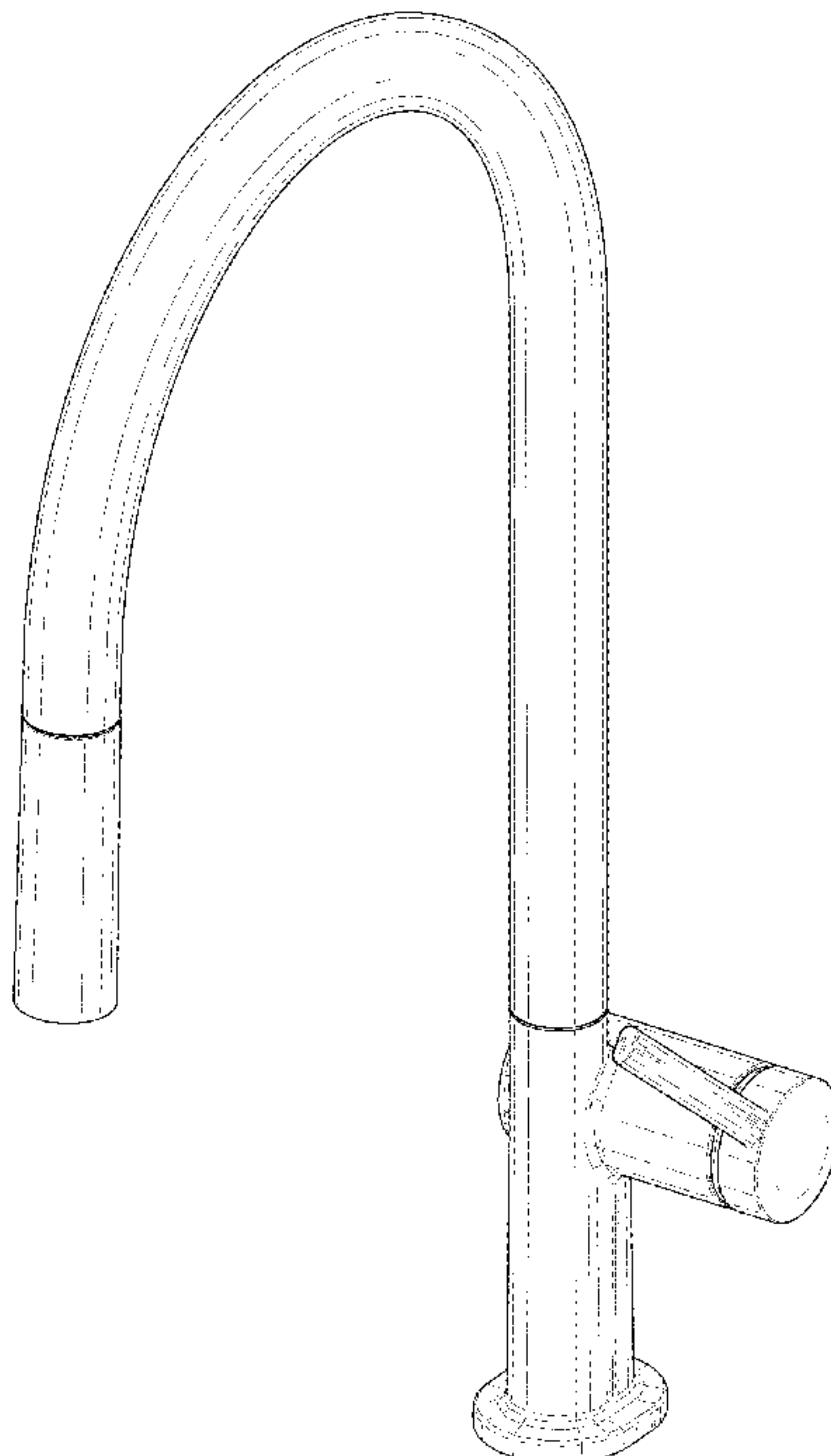

FIG. 1

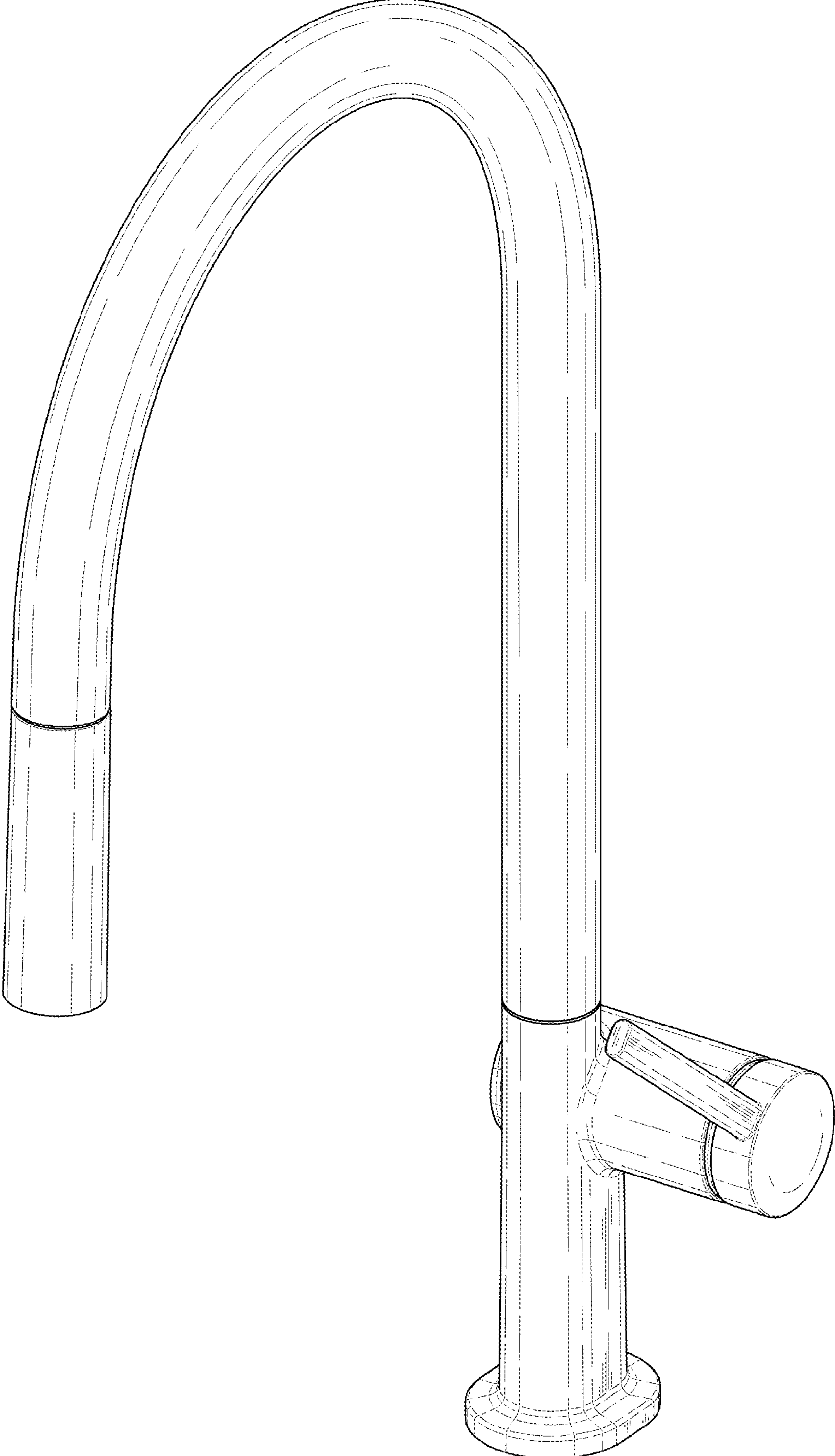

FIG. 2

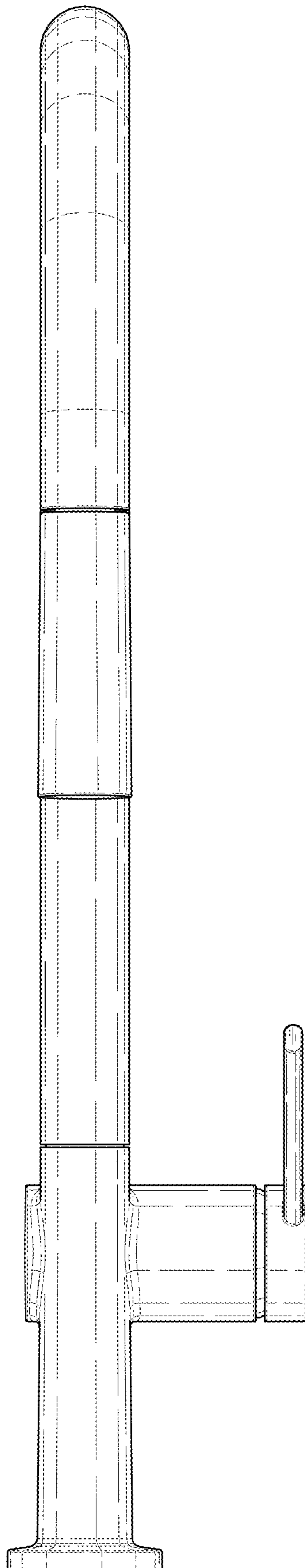

FIG. 3

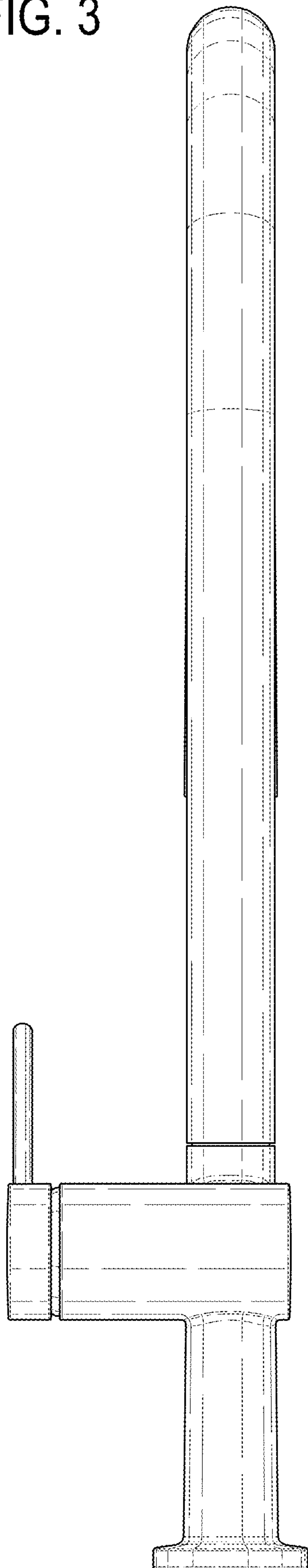

FIG. 4

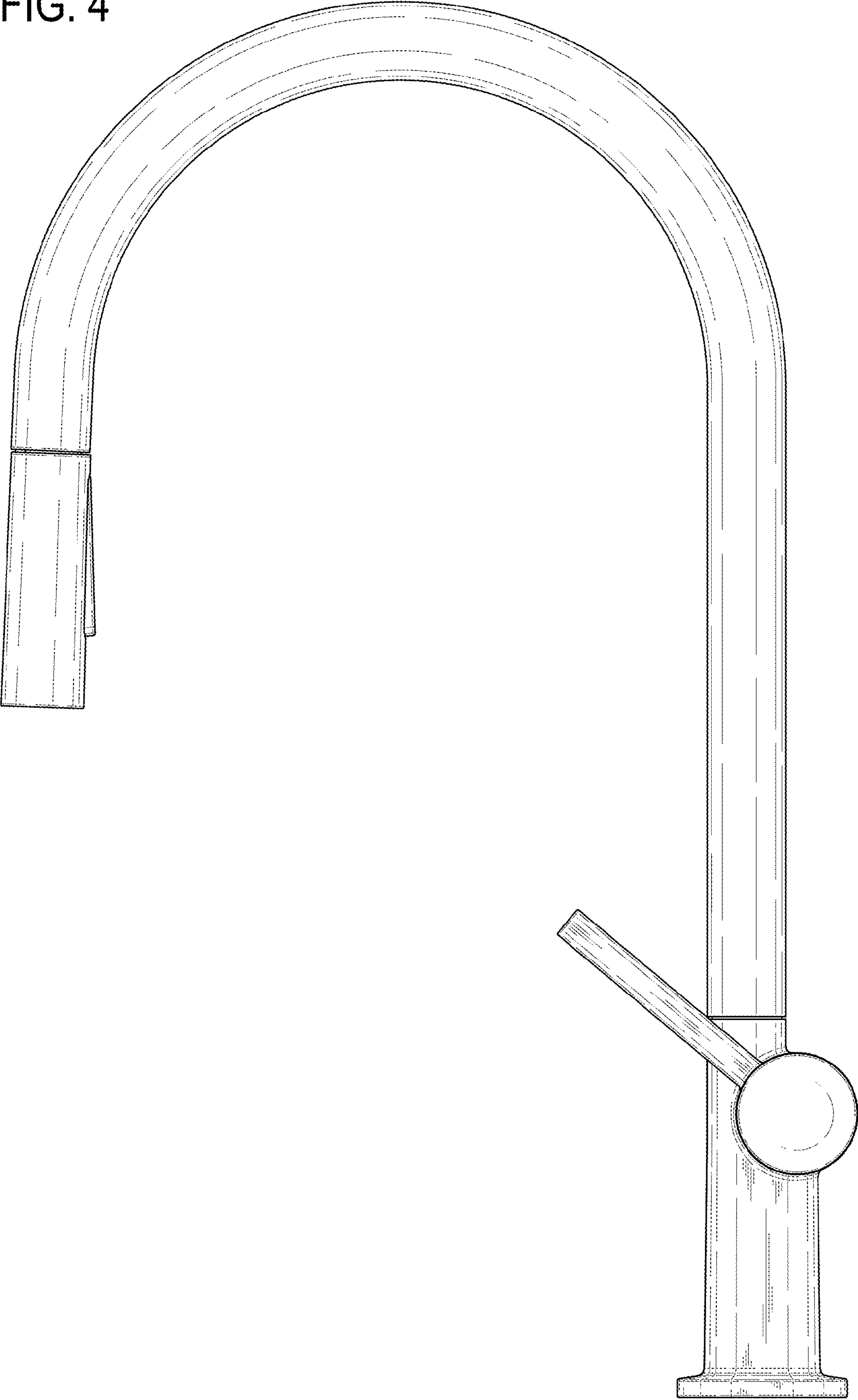



FIG. 5

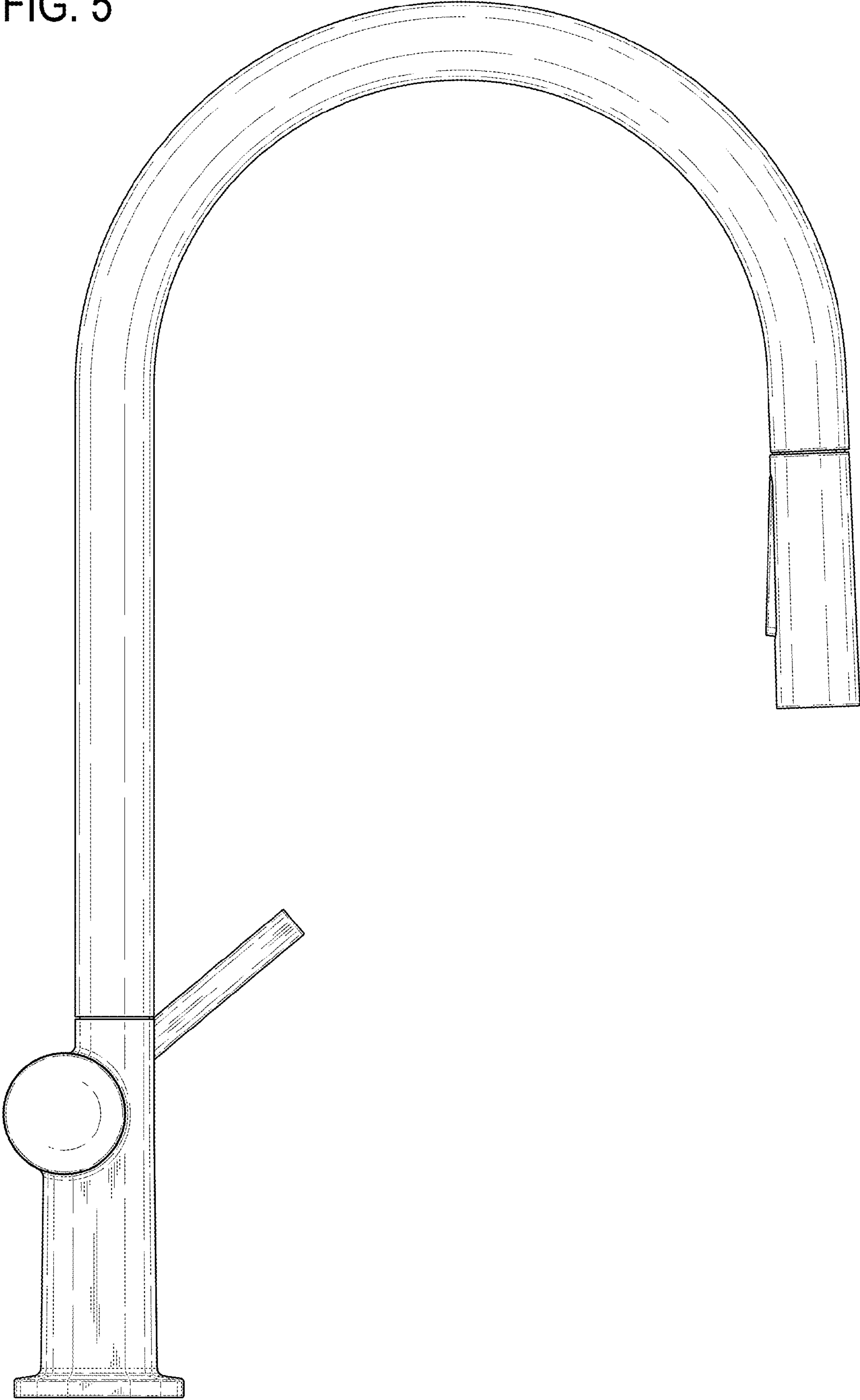

FIG. 6

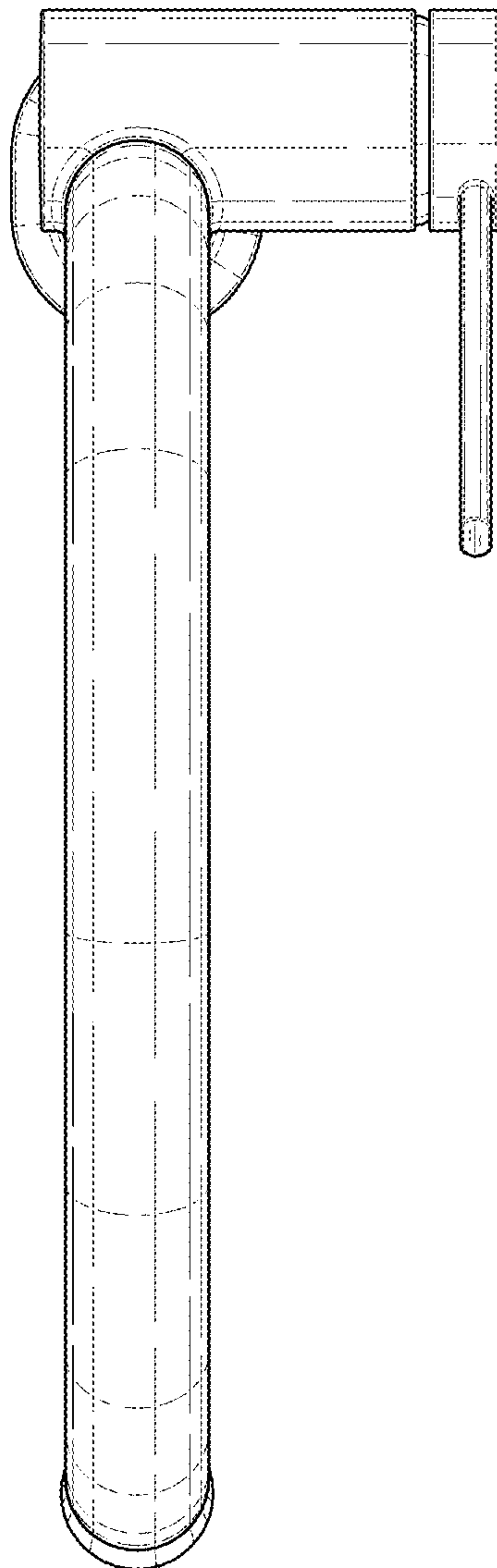

FIG. 7

