



US00D914080S

(12) **United States Design Patent**
Crescenzi et al.

(10) **Patent No.:** **US D914,080 S**
(45) **Date of Patent:** **** Mar. 23, 2021**

(54) **GLASSES NOSE PIECE**
(71) Applicant: **Liberty Sport, Inc.**, Fairfield, NJ (US)
(72) Inventors: **Deni Crescenzi**, Toronto (CA); **Kevin Pierre Meric**, Caudry (FR); **Richard Chau Quoc-Hue**, Markham (CA); **Jason Clerk**, Ontario (CA)
(73) Assignee: **Liberty Sport, Inc.**, Fairfield, NJ (US)
(**) Term: **15 Years**

(21) Appl. No.: **29/698,285**
(22) Filed: **Jul. 16, 2019**
(51) **LOC (13) Cl.** **16-06**
(52) **U.S. Cl.**
USPC **D16/332**
(58) **Field of Classification Search**
USPC 351/43, 44-47, 49, 59, 63, 69, 104, 123, 351/126, 131, 132, 135, 145; D16/101, D16/300-342; D29/108-110; D14/372
CPC G02C 5/22; G02C 5/2218; G02C 5/2236; G02C 5/2245; G02C 5/2254; G02C 5/2272; G02C 5/14; G02C 5/143; G02C 5/146; G02C 5/18; G02C 5/20; G02C 5/12; G02C 5/124; G02C 5/126; G02C 11/02; G02C 11/06; G02C 7/10; G02C 9/04; A61F 9/00
See application file for complete search history.

(56) **References Cited**
U.S. PATENT DOCUMENTS

4,704,015 A * 11/1987 Grendol G02C 5/126
351/137
4,953,967 A * 9/1990 Somerville G02C 3/003
351/136
5,387,949 A * 2/1995 Tackles G02C 1/02
351/110
D366,056 S * 1/1996 Wolfe D16/314
6,196,681 B1 * 3/2001 Canavan G02C 5/00
351/106

D475,733 S * 6/2003 Lee D16/335
6,582,074 B1 * 6/2003 Chen G02C 5/12
351/136
D485,856 S * 1/2004 Wolfe D16/314
(Continued)

FOREIGN PATENT DOCUMENTS

CN 301105252 * 1/2010
CN 303711331 * 6/2016
(Continued)

OTHER PUBLICATIONS

Google search: "nose pads for glasses" [site visited Oct. 22, 2020]:
<URL: https://www.google.com/search?q=nose+pads+for+glasses&hl=en&sxsr=ALeKk01tw10kx8axqWev_kmPbT367dgJyw:1603417528883&source=lnms&tbm=isch&sa=X&ved=2ahUKEwjz_PDhy8nsAhWamHIEHTxRDAEQ_AUoAnoECCcQBA&biw=1200&bih=1777> (Year: 2020).
(Continued)

Primary Examiner — Sanjeev Paul
(74) *Attorney, Agent, or Firm* — Myers Wolin, LLC

(57) **CLAIM**

The ornamental design for a glasses nose piece, as shown and described.

DESCRIPTION

FIG. 1 is a top right perspective view of glasses nose piece showing my new design in a state of use;
FIG. 2 is a front perspective view thereof;
FIG. 3 is a front view thereof;
FIG. 4 is a back view thereof;
FIG. 5 is a side view thereof;
FIG. 6 is a top view thereof; and,
FIG. 7 is a bottom view thereof.
The broken lines show in in the drawings figures are included for the purpose of illustrating unclaimed portions of the glasses nose piece and form no part of the claimed design.

1 Claim, 5 Drawing Sheets

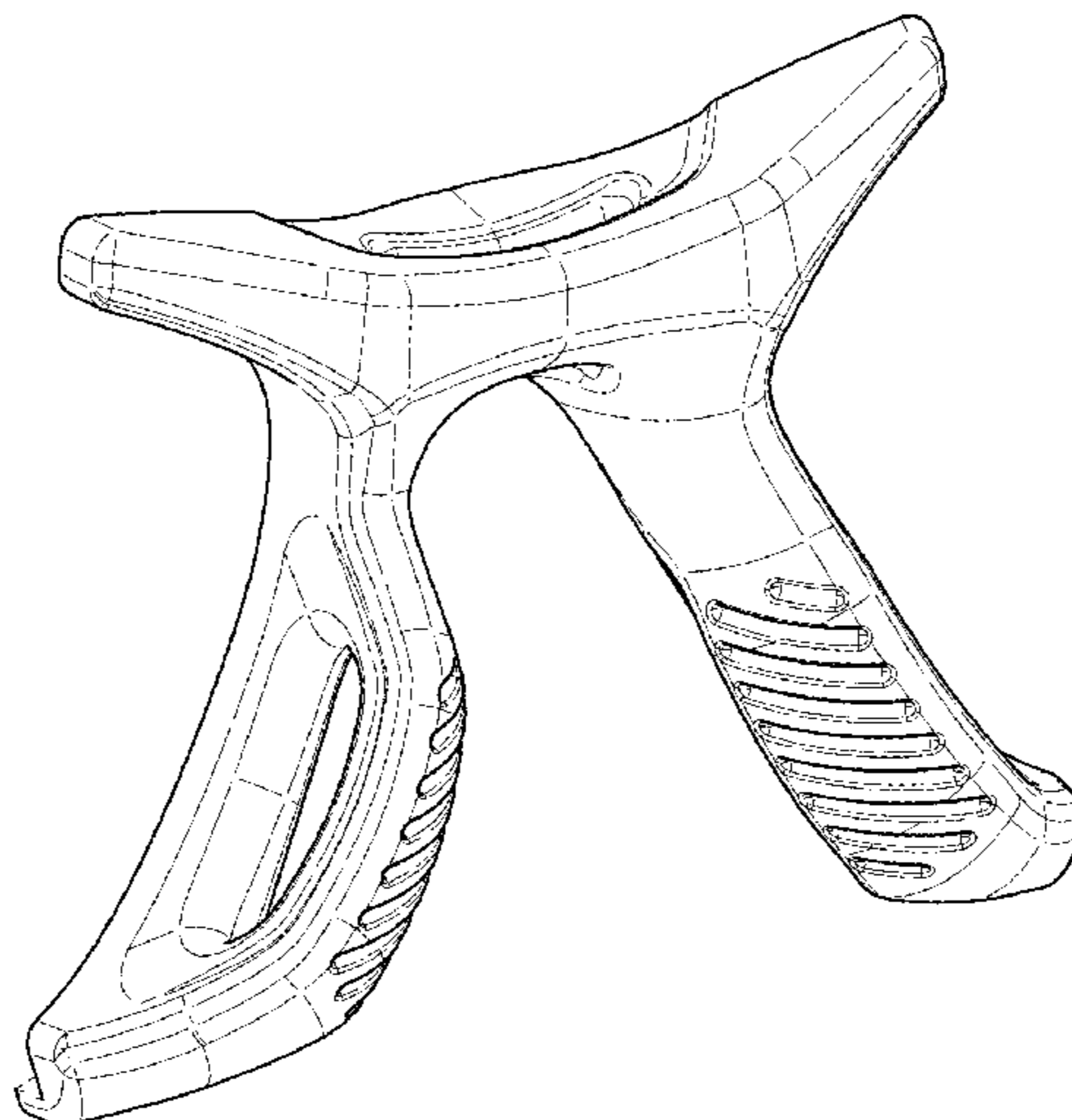

(56)

References Cited

U.S. PATENT DOCUMENTS

D516,111 S * 2/2006 Teng D16/326
 D535,318 S * 1/2007 Teng D16/326
 D540,368 S * 4/2007 Yang D16/315
 D555,708 S * 11/2007 Cheng D16/327
 7,380,933 B1 * 6/2008 Wang G02C 1/04
 7,380,934 B1 * 6/2008 Wang Lee G02C 5/122
 7,452,068 B2 * 11/2008 Collier G02C 5/12
 7,484,843 B1 * 2/2009 Lin G02C 5/126
 7,641,333 B2 * 1/2010 Blanshay A61F 9/028
 D609,736 S * 2/2010 Wang D16/326
 D617,364 S * 6/2010 Chou D16/315
 D623,218 S * 9/2010 Wong D16/332
 D625,351 S * 10/2010 Wong D16/332
 D651,641 S * 1/2012 Fulton D16/333
 D690,762 S * 10/2013 Yang D16/315
 D709,550 S * 7/2014 Sheldon D16/321
 D719,608 S * 12/2014 DiChiara D16/332
 8,931,894 B1 * 1/2015 Chen G02C 5/12
 D740,347 S * 10/2015 Corcoran D16/326
 D798,375 S * 9/2017 Flake D16/332
 D809,056 S * 1/2018 Flake D16/330
 9,958,702 B1 * 5/2018 Chen G02C 5/126
 D835,178 S * 12/2018 Miera D16/314
 D837,871 S * 1/2019 Canales D16/314
 10,274,747 B1 * 4/2019 Chen G02C 5/124
 D849,823 S * 5/2019 Canales D16/313
 D849,825 S * 5/2019 Canales D16/314
 D850,523 S * 6/2019 Yang D16/326
 D851,165 S * 6/2019 Sanchez D16/326
 D854,608 S * 7/2019 Sanchez D16/326
 D888,144 S * 6/2020 Sanchez D16/330
 D889,531 S * 7/2020 Canales D16/330
 D890,247 S * 7/2020 Yang D16/314
 2006/0238697 A1 * 10/2006 Teng G02C 9/00
 2007/0109490 A1 * 5/2007 Collier G02C 5/12
 2007/0236649 A1 * 10/2007 Lin G02C 5/02

2008/0170200 A1 * 7/2008 Chen G02C 5/122
 2011/0025974 A1 * 2/2011 Schepke G02C 1/04
 2011/0176101 A1 * 7/2011 Dighton G02C 5/008
 2011/0317122 A1 * 12/2011 Havens-Olmstead ... G02C 5/12
 2014/0340628 A1 * 11/2014 Huang G02C 5/006
 2014/0375948 A1 * 12/2014 Chen G02C 5/124
 2016/0103332 A1 * 4/2016 Lin G02C 5/122
 2016/0103333 A1 * 4/2016 DiChiara G02C 1/08
 2016/0291345 A1 * 10/2016 Lee G02C 5/126
 2017/0336648 A1 * 11/2017 Chen G02C 1/08
 2017/0357104 A1 * 12/2017 Chen G02C 1/08
 2018/0107019 A1 * 4/2018 Chen G02C 5/12
 2018/0329226 A1 * 11/2018 Lussier G02C 1/04
 2019/0107732 A1 * 4/2019 Canales G02C 1/02

FOREIGN PATENT DOCUMENTS

CN 305076582 * 3/2019
 CN 305878803 * 12/2019
 KR 300826075 * 11/2015

OTHER PUBLICATIONS

Google search: "sports eyeglasses nose pads" [site visited Oct. 22, 2020]: <URL: https://www.google.com/search?q=sports+eyeglasses+nose+pads&hl=en&sxsrf=ALeKk00pza8AcoTKxrL1Hi8d-Sqv0ZY9nQ:1603430256892&source=lnms&tbm=isch&sa=X&ved=2ahUKEwi-glmX-8nsAhUggXIEHYrlAuQQ_AUoAnoECCcQBA&biw=1200&bih=1777> (Year: 2020).*

Google search: "eyeglasses nose pads" [site visited Oct. 22, 2020]: <URL: https://www.google.com/search?q=eyeglasses+nose+pads&hl=en&sxsrf=ALeKk017RbfBcBFi3xu2F8i9twFqQF1x2w:1603430385360&source=lnms&tbm=isch&sa=X&ved=2ahUKEwjehqrU-8nsAhX5IXIEHbeSBZEQ_AUoAnoECCUQBA&biw=1200&bih=1777> (Year: 2020).*

* cited by examiner

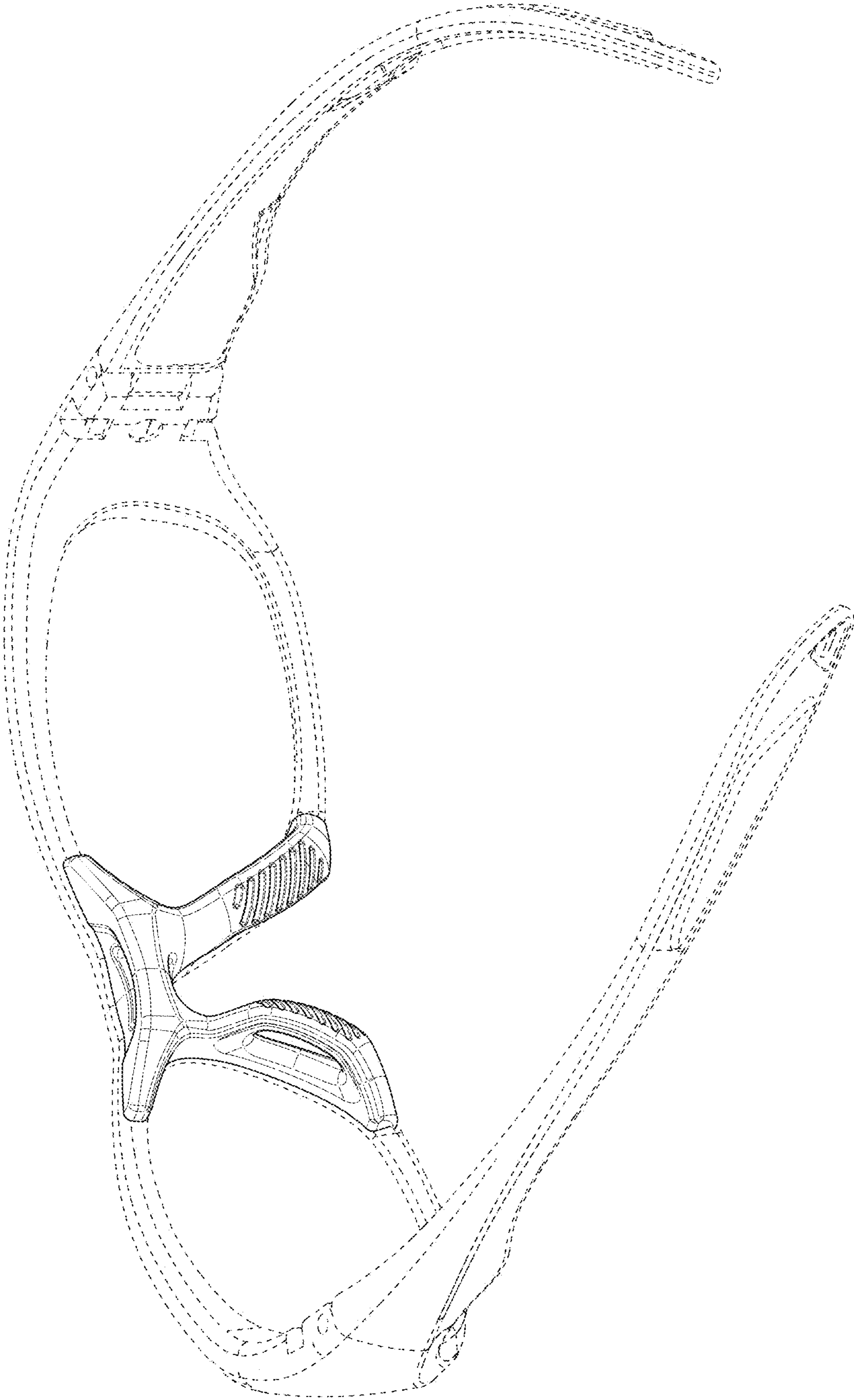

FIG. 1

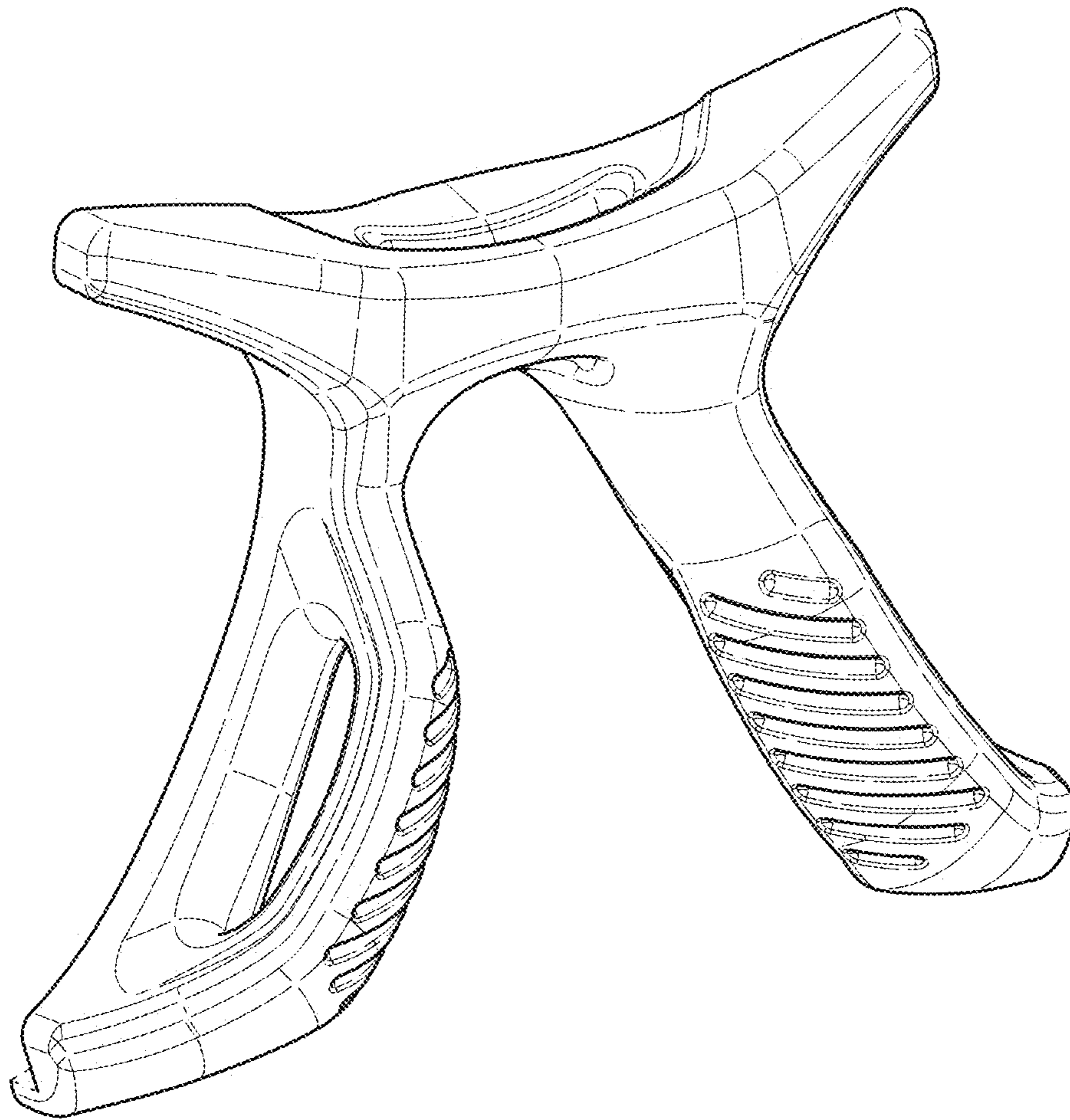

FIG. 2

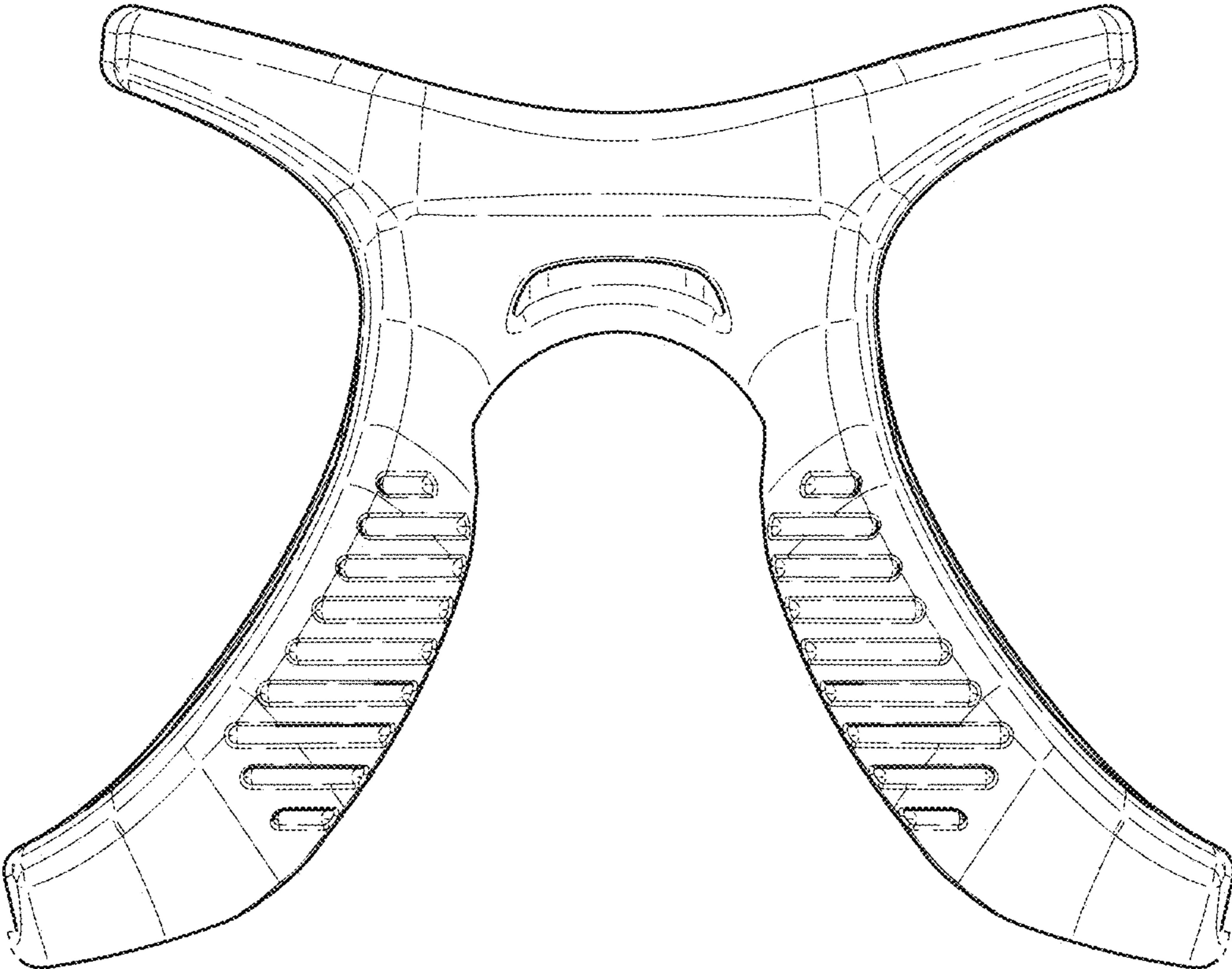

FIG. 3

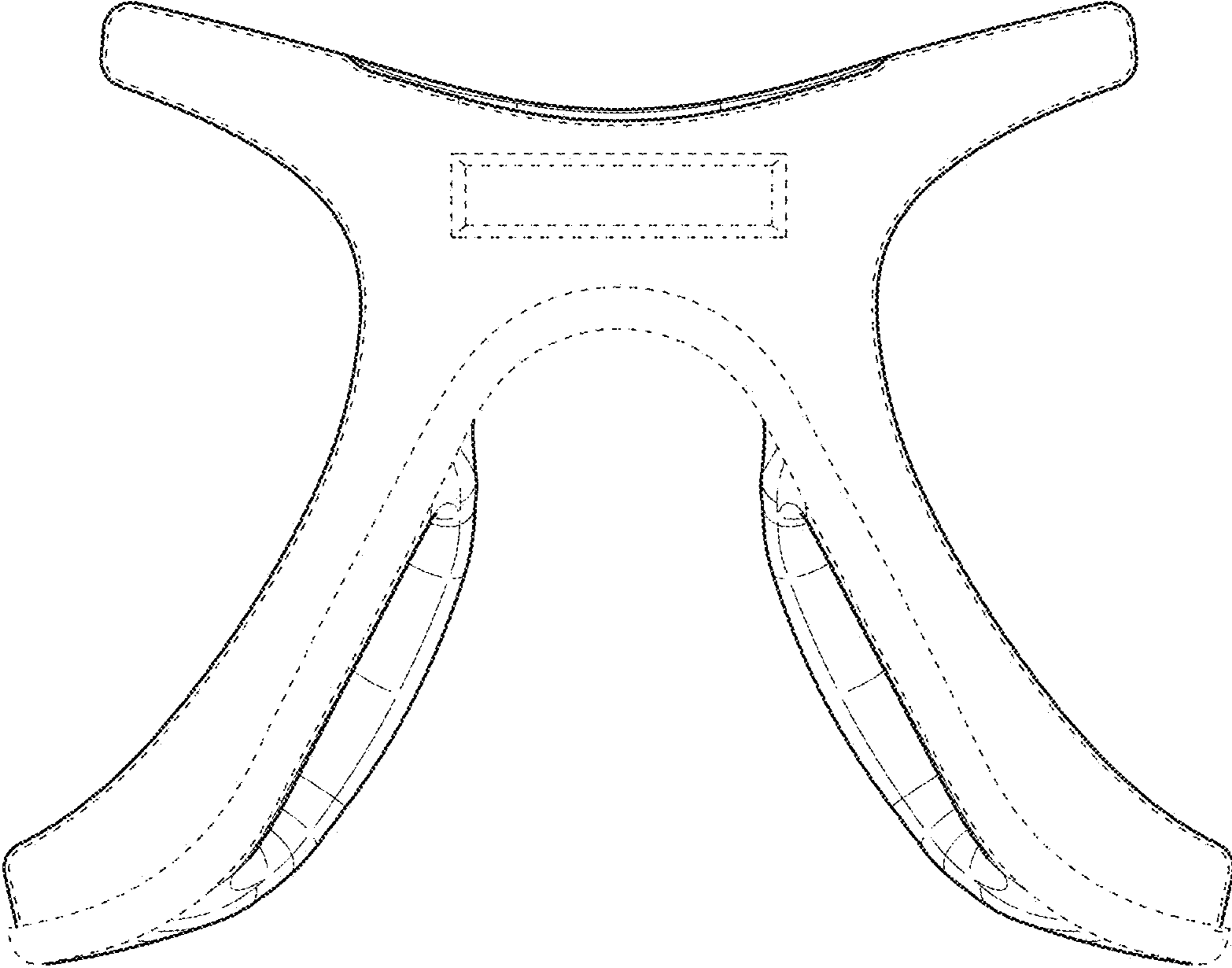

FIG. 4

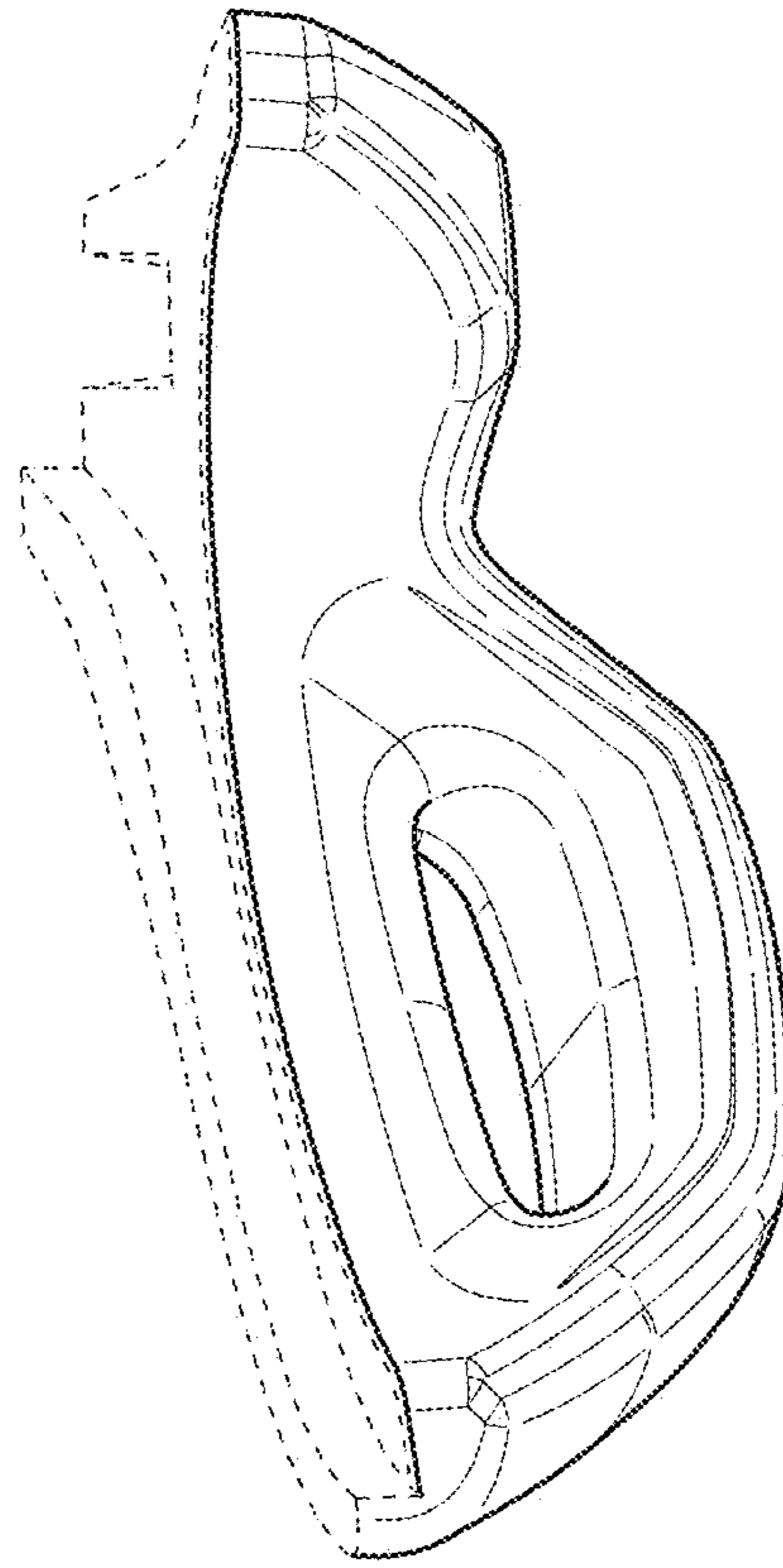

FIG. 5

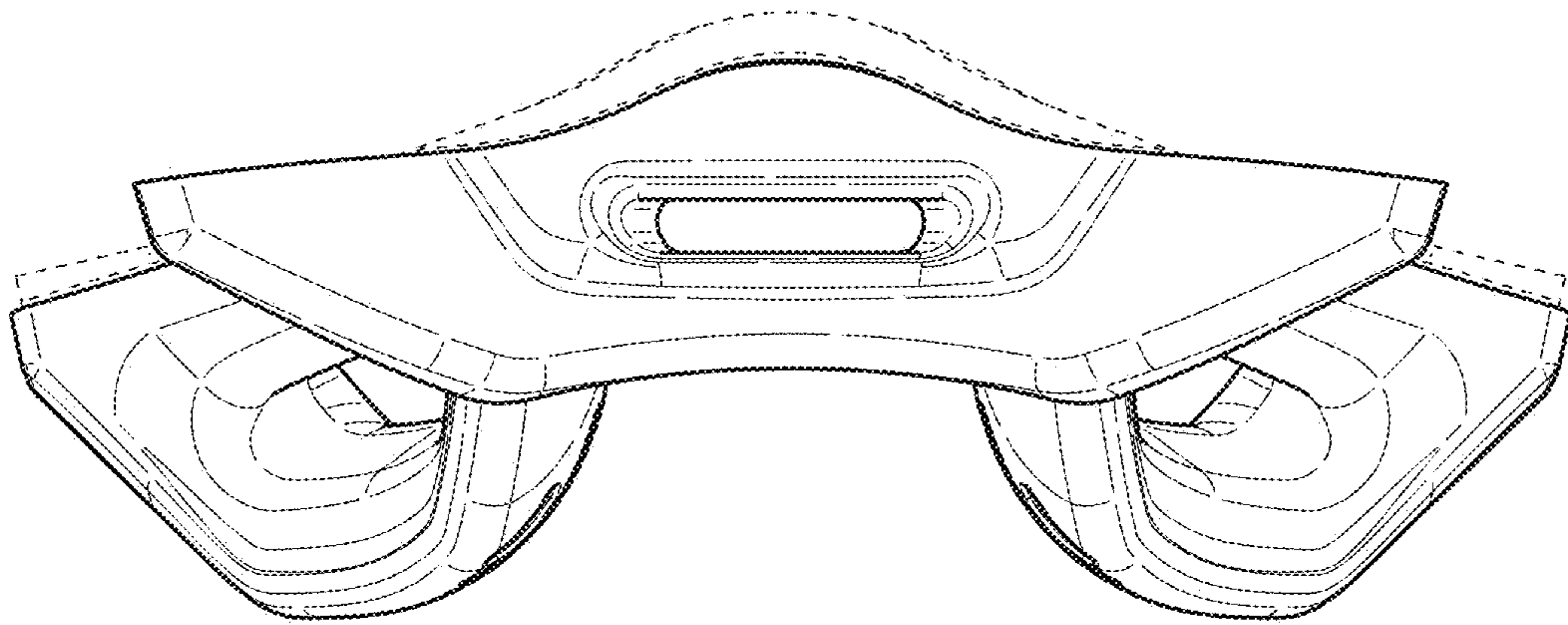

FIG. 6

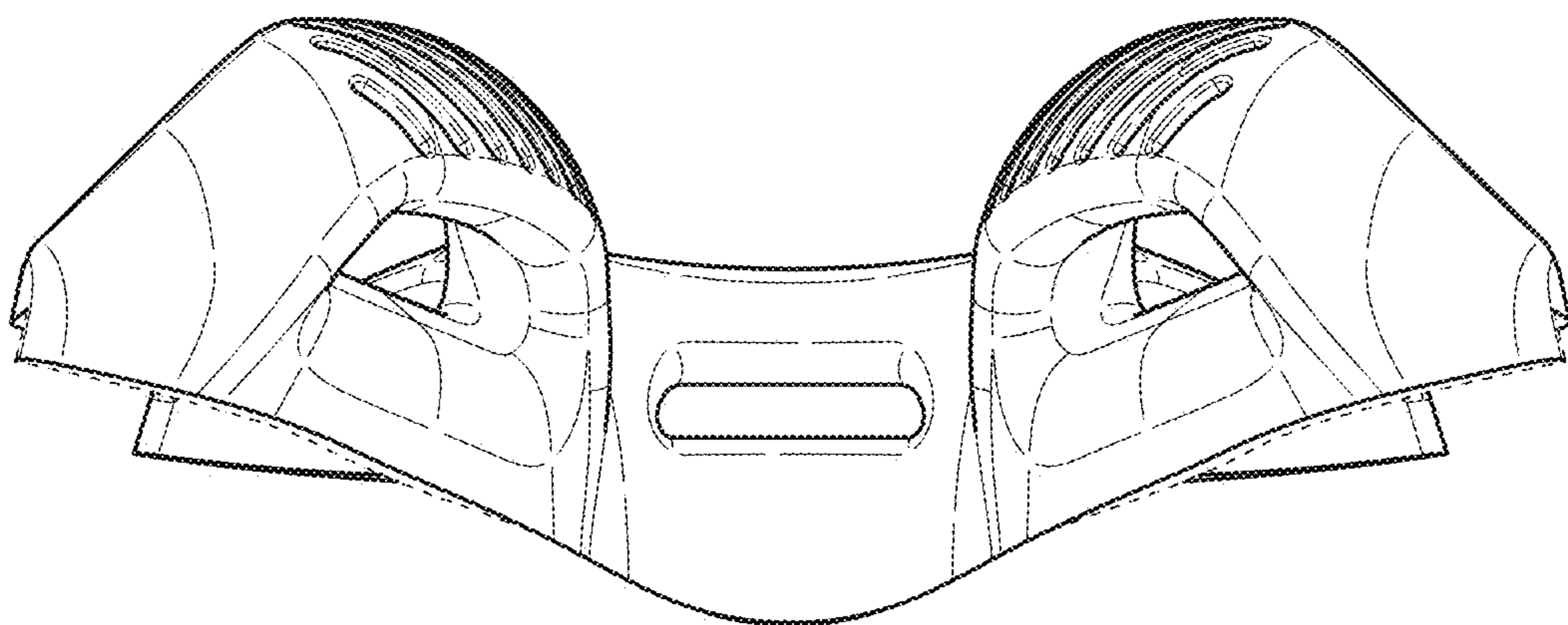

FIG. 7

UNITED STATES PATENT AND TRADEMARK OFFICE
CERTIFICATE OF CORRECTION

PATENT NO. : D914,080 S
APPLICATION NO. : 29/698285
DATED : March 23, 2021
INVENTOR(S) : Crescenzi et al.

Page 1 of 1

It is certified that error appears in the above-identified patent and that said Letters Patent is hereby corrected as shown below:

On the Title Page

Item (72):

Inventor Name to be corrected from "Richard Chau Quoc-Hue" to "Quoc-Hue Richard Chau".

The city of residence for inventor Jason Clerk to be corrected from "Ontario (CA)" to "Toronto (CA)".

Signed and Sealed this
Twenty-sixth Day of October, 2021



Drew Hirshfeld
*Performing the Functions and Duties of the
Under Secretary of Commerce for Intellectual Property and
Director of the United States Patent and Trademark Office*