



US00D914008S

(12) **United States Design Patent** (10) **Patent No.:** **US D914,008 S**  
**V-Neun et al.** (45) **Date of Patent:** **\*\* Mar. 23, 2021**

(54) **SERVER RACK SHELF**

(71) Applicant: **Innovation First, Inc.**, Greenville, TX (US)

(72) Inventors: **John V-Neun**, Rockwall, TX (US);  
**James Whitney Wilson**, Nevada, TX (US); **Jacob Vierus**, Rockwall, TX (US); **Douglas Michael Galletti**, Allen, TX (US)

(73) Assignee: **Innovation First, Inc.**, Greenville, TX (US)

(\*\*) Term: **15 Years**

(21) Appl. No.: **29/713,333**

(22) Filed: **Nov. 15, 2019**

(51) **LOC (13) Cl.** ..... **14-02**

(52) **U.S. Cl.**  
USPC ..... **D14/300**

(58) **Field of Classification Search**  
USPC ..... D6/672, 673, 675, 675.1, 682.2, 683.1;  
D3/304, 310, 313, 319; D14/300, 313  
CPC ..... H05K 7/14; H05K 7/1404; H05K 7/1411;  
H05K 7/1461; H05K 7/1489; H05K  
7/183; H05K 7/1488; H05K 7/1421;  
H05K 7/1485; F16B 2/24  
See application file for complete search history.

(56) **References Cited**

**U.S. PATENT DOCUMENTS**

D270,678 S \* 9/1983 Stein ..... D3/304  
4,577,914 A \* 3/1986 Stravitz ..... G11B 33/04  
206/387.14  
D308,777 S \* 6/1990 Gambello ..... D6/682.2  
D311,624 S \* 10/1990 O'Leary ..... D3/304

(Continued)

*Primary Examiner* — Steven J Czyz

(74) *Attorney, Agent, or Firm* — Adam K. Sacharoff;  
Much Shelist, P.C.

(57) **CLAIM**

The ornamental design for a server rack shelf, as shown and described.

**DESCRIPTION**

FIG. 1 is a front left side perspective view of a server rack shelf showing our new design;  
FIG. 2 is a cross sectional front left side perspective view thereof taken along section line 2-2 from FIG. 1;  
FIG. 3 front right side perspective view thereof;  
FIG. 4 is a cross sectional front right side perspective view thereof taken along section line 4-4 from FIG. 3;  
FIG. 5 is another front right side perspective view thereof taken from an elevated perspective;  
FIG. 6 is a rear left side perspective view thereof;  
FIG. 7 is a cross sectional rear left side perspective view thereof taken along section line 7-7 from FIG. 6;  
FIG. 8 is a rear right side perspective view thereof;  
FIG. 9 is a cross sectional rear right side perspective view thereof taken along section line 9-9 from FIG. 8;  
FIG. 10 is a front view thereof;  
FIG. 11 is a rear view thereof;  
FIG. 12 is a left side view thereof;  
FIG. 13 is a right side view thereof;  
FIG. 14 is a top plan view thereof;  
FIG. 15 is a bottom plan view thereof;  
FIG. 16 is a right side front perspective view thereof;  
FIG. 17 cross sectional right side front perspective view thereof taken along line 17-17 from FIG. 16;  
FIG. 18 is a left side front perspective view thereof;  
FIG. 19 is a cross sectional left side front perspective view thereof taken along line 19-19 from FIG. 18;  
FIG. 20 is a front right perspective view thereof; and,  
FIG. 21 is a cross sectional front right perspective view thereof taken along line 21-21 from FIG. 20.  
The broken lines shown in the drawings depict portions of the server rack shelf that form no part of the claimed design.

**1 Claim, 21 Drawing Sheets**

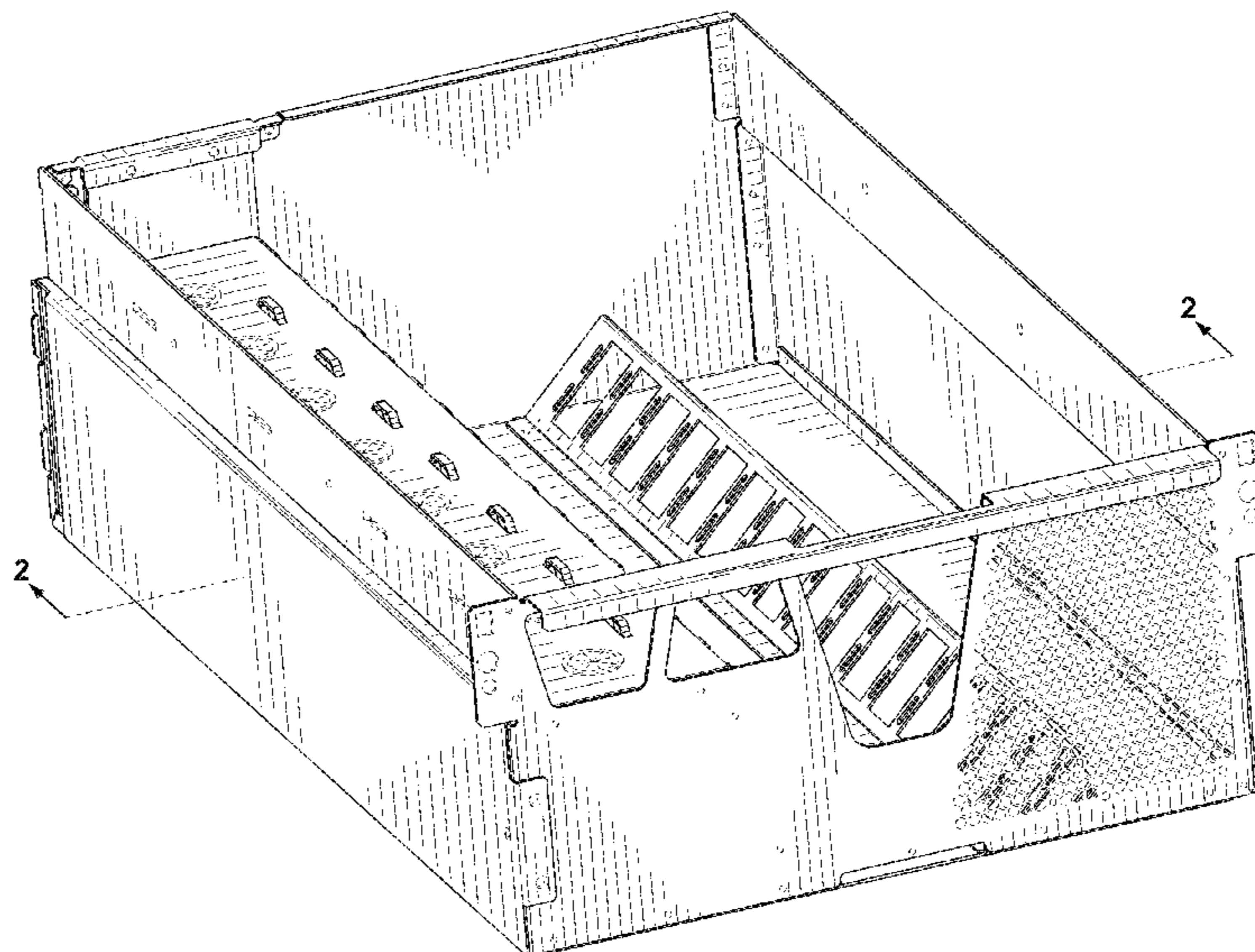

(56)

References Cited

U.S. PATENT DOCUMENTS

D327,971 S \* 7/1992 Cugley ..... D3/304  
 RE34,369 E \* 9/1993 Darden ..... G06F 1/18  
 439/374  
 D344,838 S \* 3/1994 Hakansson ..... D3/304  
 5,483,420 A \* 1/1996 Schiavini ..... H05K 7/1404  
 211/41.17  
 D402,130 S \* 12/1998 Wolff ..... D6/675  
 5,883,784 A \* 3/1999 Hughes ..... H05K 7/1404  
 174/16.3  
 5,884,779 A \* 3/1999 Rich ..... H05K 7/1404  
 211/41.17  
 5,909,359 A \* 6/1999 Summers ..... G06F 1/184  
 174/250  
 5,914,854 A \* 6/1999 Holt ..... G06F 1/184  
 361/679.23  
 D413,442 S \* 9/1999 Jacober ..... D3/304  
 5,954,301 A \* 9/1999 Joseph ..... H01R 9/2416  
 248/68.1  
 6,011,701 A \* 1/2000 Kopp ..... A47B 21/00  
 361/818  
 D429,093 S \* 8/2000 Miller ..... D6/683.1  
 6,166,902 A \* 12/2000 Liu ..... G06F 1/181  
 361/679.58  
 6,272,016 B1 \* 8/2001 Matonis ..... H05K 7/1404  
 165/80.3  
 6,309,237 B1 \* 10/2001 Longueville ..... H05K 7/1418  
 439/267  
 D452,078 S \* 12/2001 Dembicks ..... D3/313  
 D462,874 S \* 9/2002 Simcox ..... D3/313  
 D472,710 S \* 4/2003 Dembicks ..... D3/313  
 6,642,447 B1 \* 11/2003 Mailloux ..... H02G 3/081  
 174/17 R  
 D485,702 S \* 1/2004 Becker ..... D6/672  
 D487,971 S \* 4/2004 Bergeron ..... D3/313  
 D492,484 S \* 7/2004 Lin ..... D3/260  
 6,768,651 B2 \* 7/2004 Takahashi ..... G02B 6/3897  
 361/688  
 D496,179 S \* 9/2004 Sjoberg ..... D6/675  
 D513,124 S \* 12/2005 Funk ..... D3/313  
 D519,279 S \* 4/2006 Krebs ..... D3/304  
 D538,537 S \* 3/2007 Osborn ..... D3/313  
 7,263,620 B2 \* 8/2007 Bresniker ..... G06F 1/18  
 340/540

7,265,968 B2 \* 9/2007 Champion ..... G06F 1/185  
 361/679.01  
 D565,322 S \* 4/2008 Mason ..... D6/675  
 D586,583 S \* 2/2009 Schluter ..... D6/675  
 7,823,866 B1 \* 11/2010 Pluymers ..... H05K 7/1404  
 269/254 CS  
 8,223,494 B2 \* 7/2012 Bult ..... H05K 7/1404  
 361/700  
 D677,254 S \* 3/2013 Crisp ..... D14/300  
 8,477,498 B2 \* 7/2013 Porreca ..... H05K 7/1404  
 361/704  
 8,582,302 B2 \* 11/2013 Peterson ..... H05K 7/1492  
 361/724  
 8,714,368 B2 \* 5/2014 Tichy ..... H04Q 1/10  
 211/26  
 8,861,213 B2 \* 10/2014 Sisler ..... H05K 7/20  
 361/756  
 D740,271 S \* 10/2015 Kishita ..... D14/300  
 D740,272 S \* 10/2015 Kishita ..... D14/300  
 9,307,629 B2 \* 4/2016 Tissot ..... H05K 1/0201  
 9,370,090 B2 \* 6/2016 Chauhan ..... H05K 3/368  
 9,370,117 B2 \* 6/2016 Franck ..... H05K 7/14  
 9,370,119 B2 \* 6/2016 Tonthat ..... A47B 88/43  
 9,414,524 B2 \* 8/2016 Zemke ..... H05K 7/2039  
 9,456,520 B1 \* 9/2016 Wilson ..... A47B 47/027  
 9,461,389 B2 \* 10/2016 Novack ..... H01R 25/162  
 9,474,175 B2 \* 10/2016 Lin ..... H05K 5/0217  
 D781,625 S \* 3/2017 Poniatowski ..... D6/683  
 9,593,997 B2 \* 3/2017 Corrigan ..... H05K 7/1404  
 D784,018 S \* 4/2017 Shamp ..... D3/304  
 D793,774 S \* 8/2017 Kelly ..... D6/675  
 9,814,156 B2 \* 11/2017 Wilson ..... H05K 7/183  
 D804,822 S \* 12/2017 Stratton ..... D3/313  
 9,924,611 B2 \* 3/2018 Tonthat ..... H05K 7/1489  
 D830,742 S \* 10/2018 Brendlinger ..... D6/672  
 10,136,540 B2 \* 11/2018 Magnoux ..... H05K 7/1485  
 D837,577 S \* 1/2019 Silkaitis ..... D6/683  
 D846,971 S \* 4/2019 Wilson ..... D8/377  
 10,292,298 B2 \* 5/2019 Yen ..... H05K 7/1491  
 D851,427 S \* 6/2019 Vezina ..... D6/672  
 10,317,949 B1 \* 6/2019 Lin ..... G06F 1/166  
 D867,792 S \* 11/2019 Vezina ..... D6/672  
 D867,793 S \* 11/2019 Davis ..... D6/675  
 10,533,919 B2 \* 1/2020 Bradbury ..... G01L 1/06  
 D891,836 S \* 8/2020 Silkaitis ..... D6/683  
 10,791,652 B2 \* 9/2020 Thompson ..... H05K 7/2049

\* cited by examiner

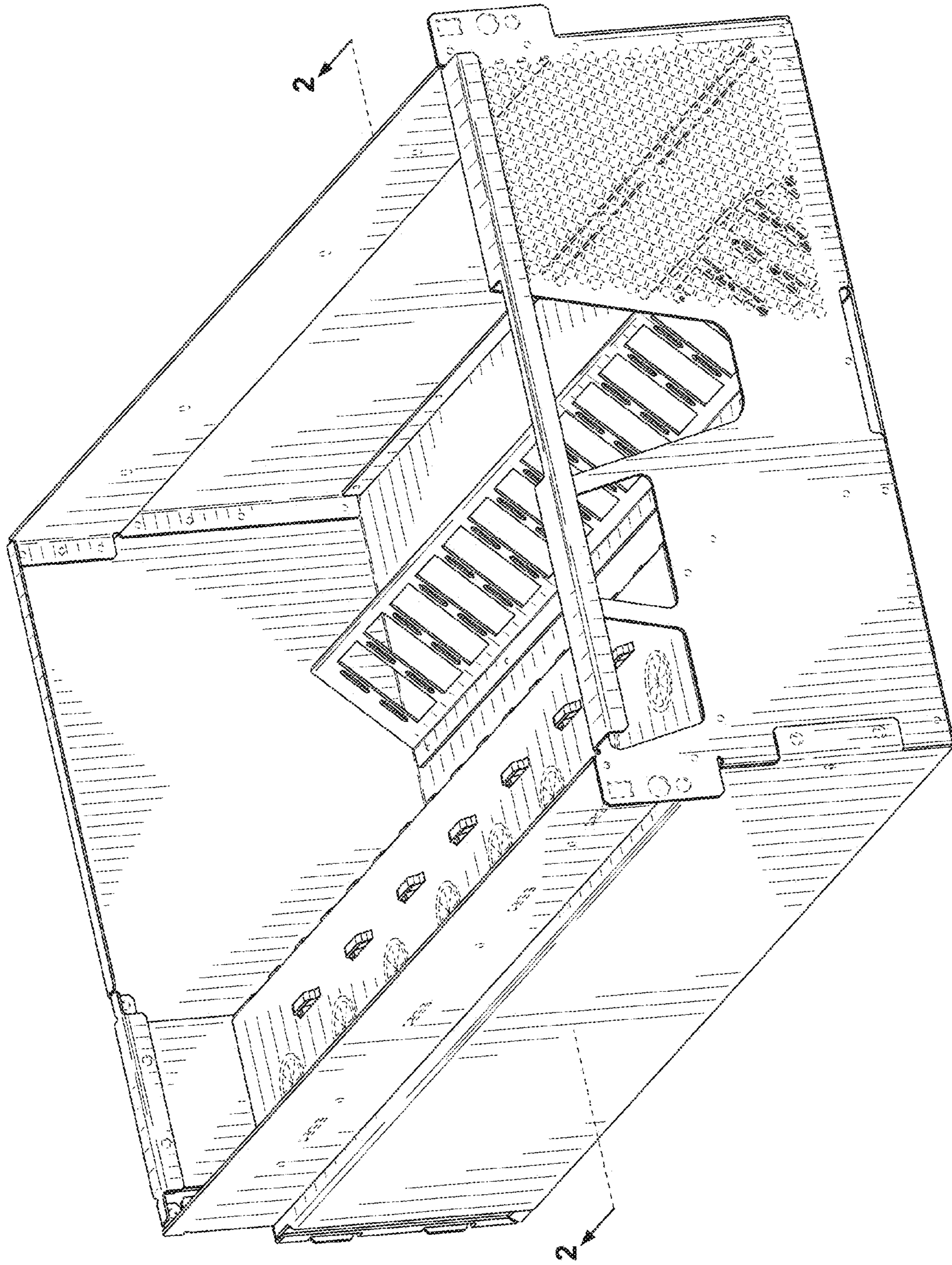

FIG. 1

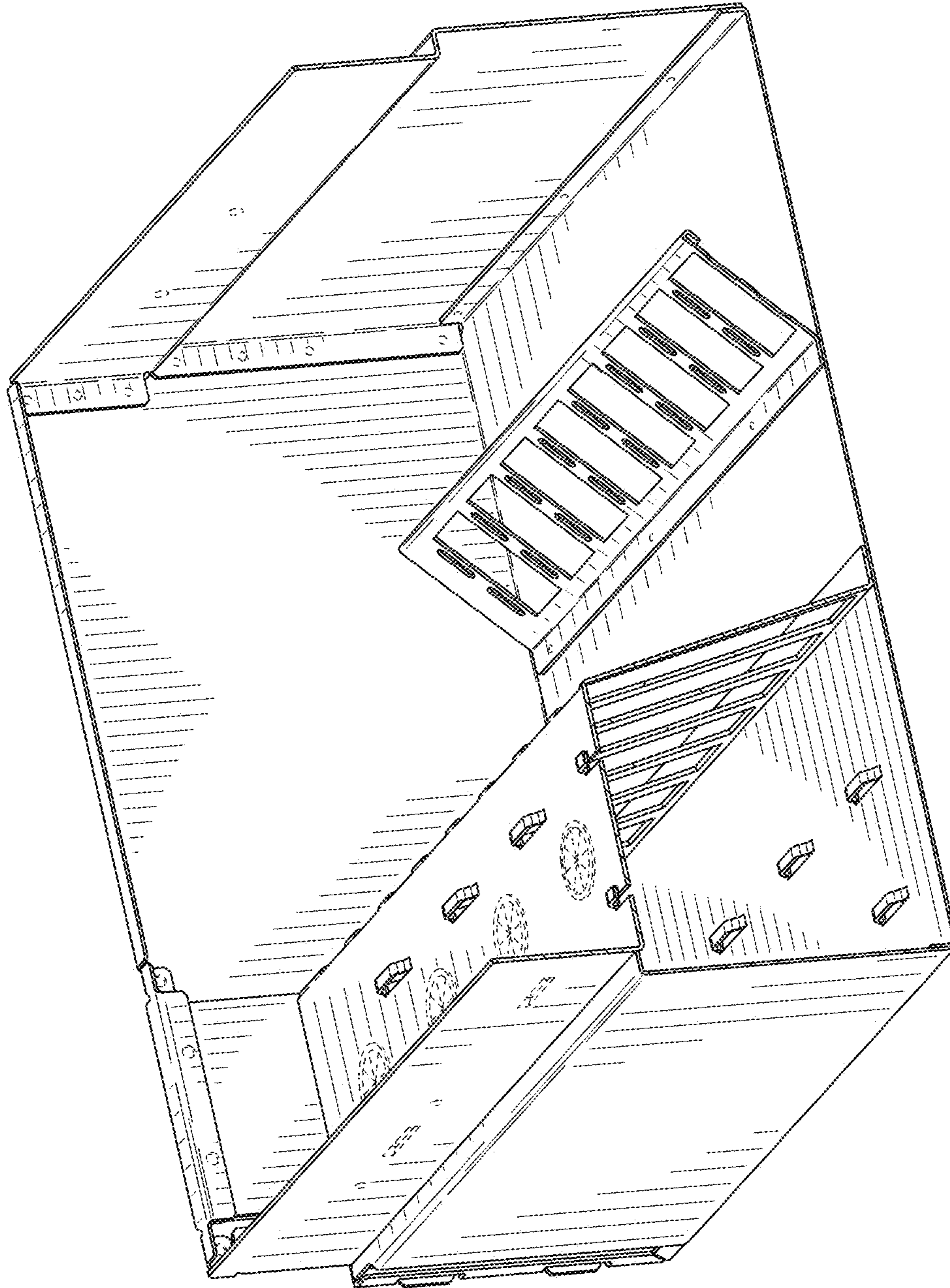

FIG. 2

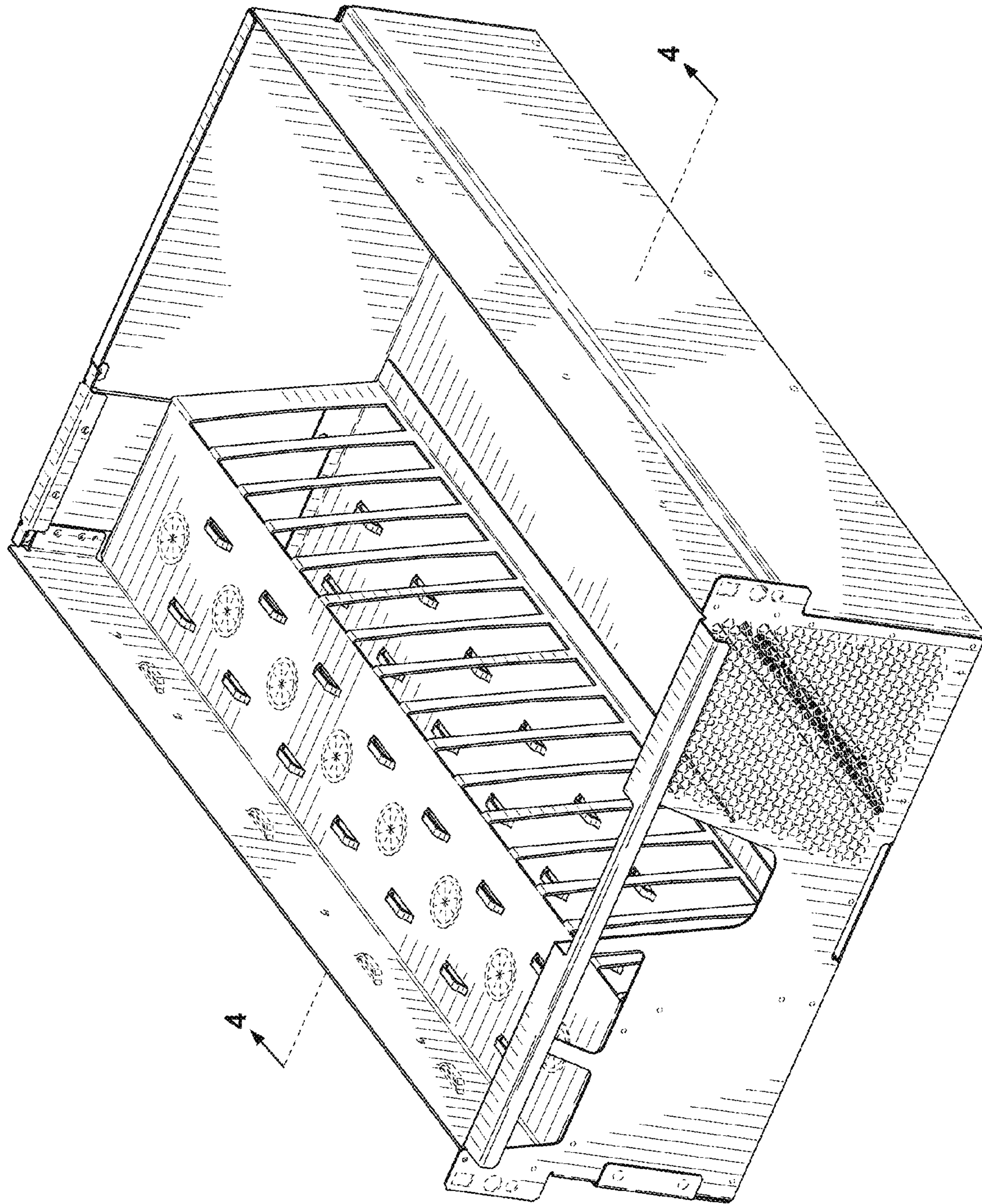

FIG. 3

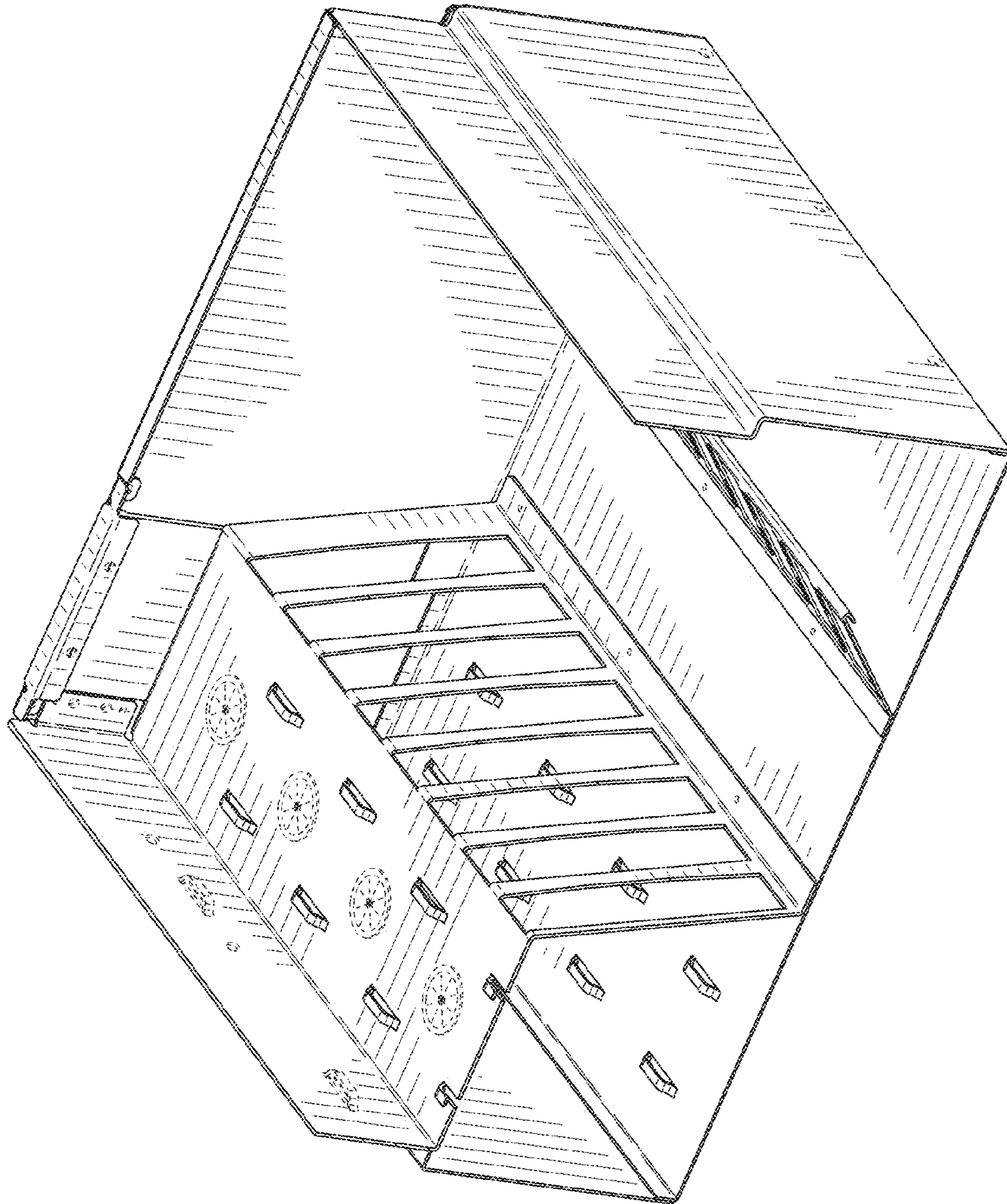

FIG. 4

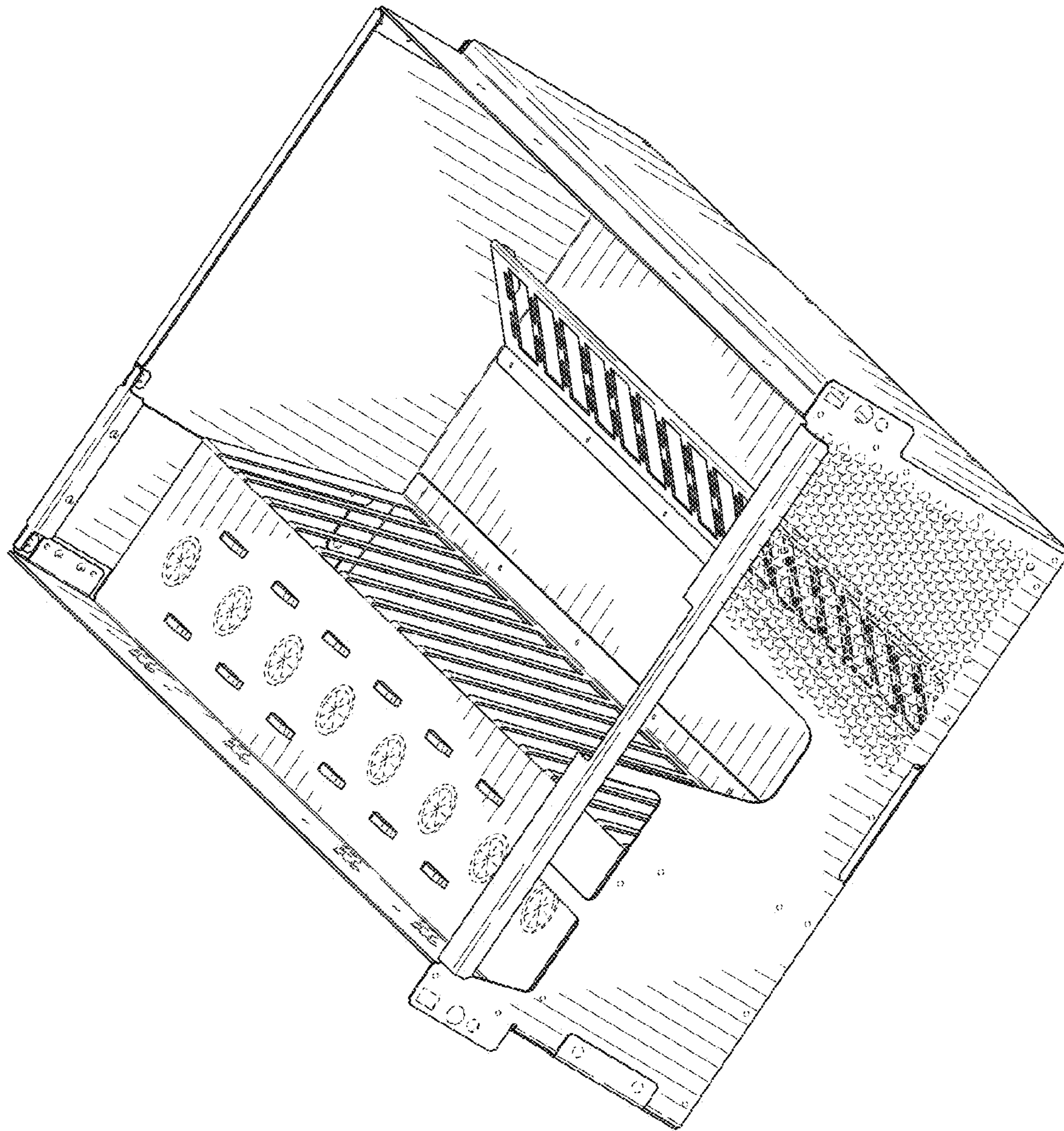

FIG. 5

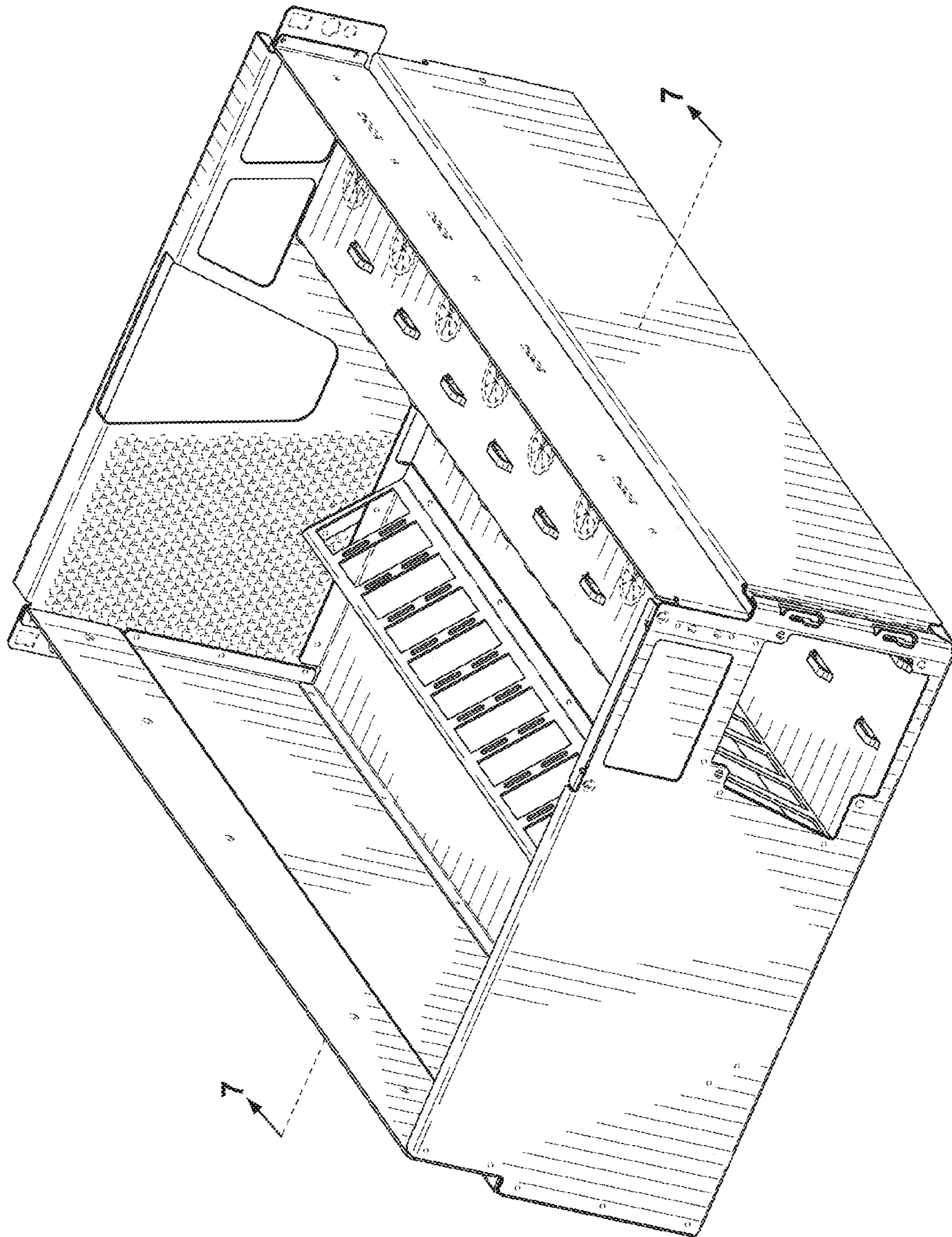

FIG. 6



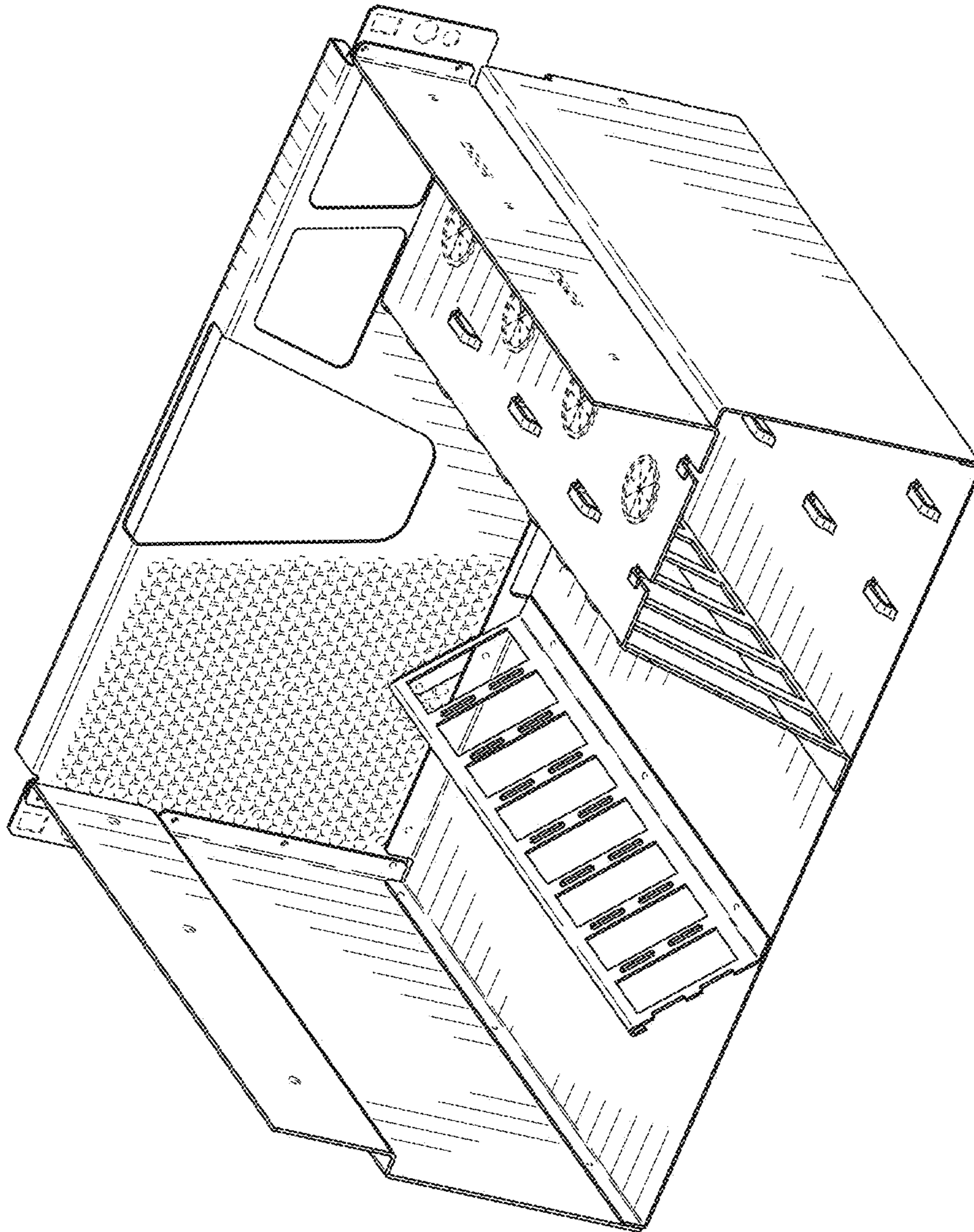

FIG. 7

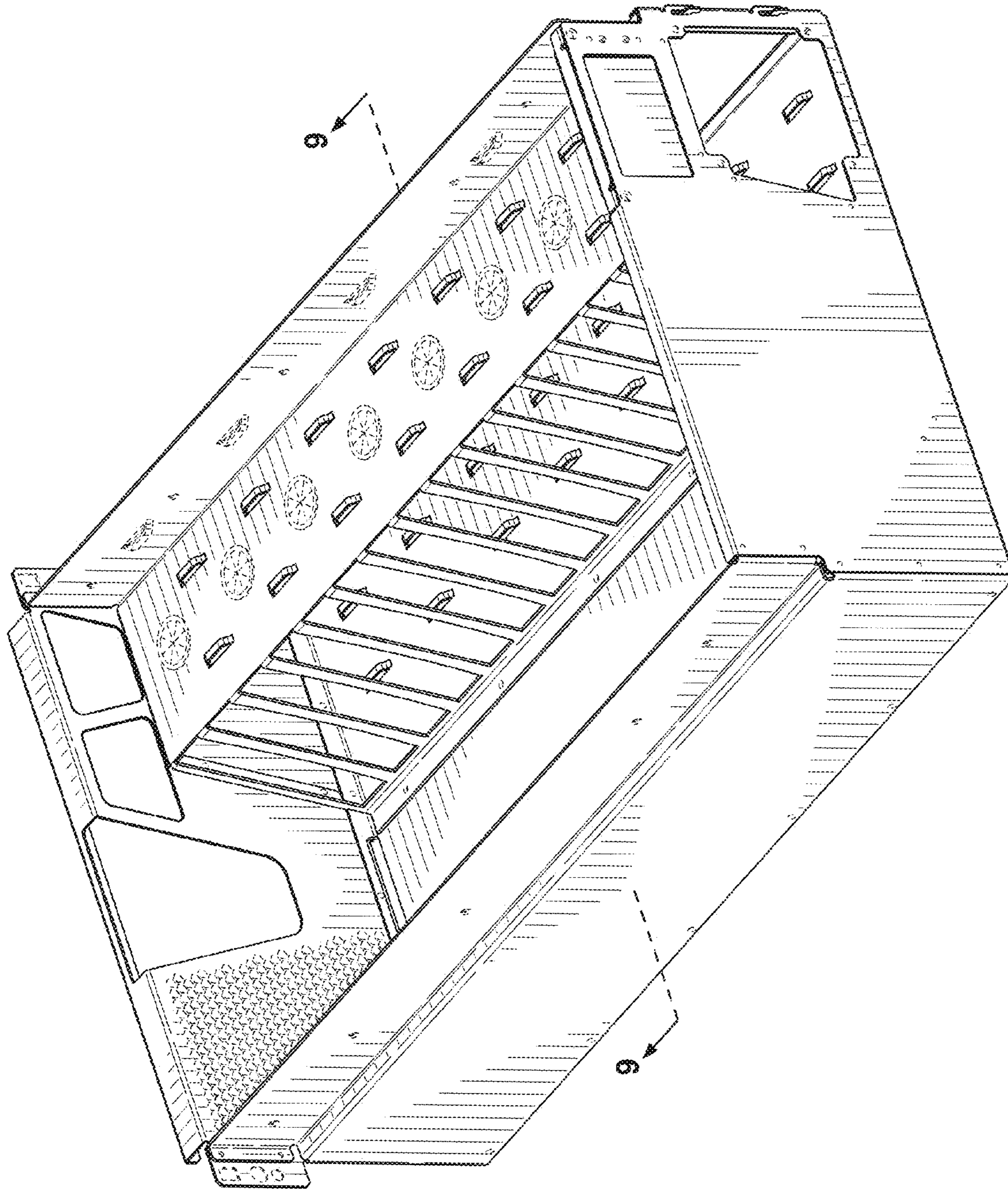

FIG. 8

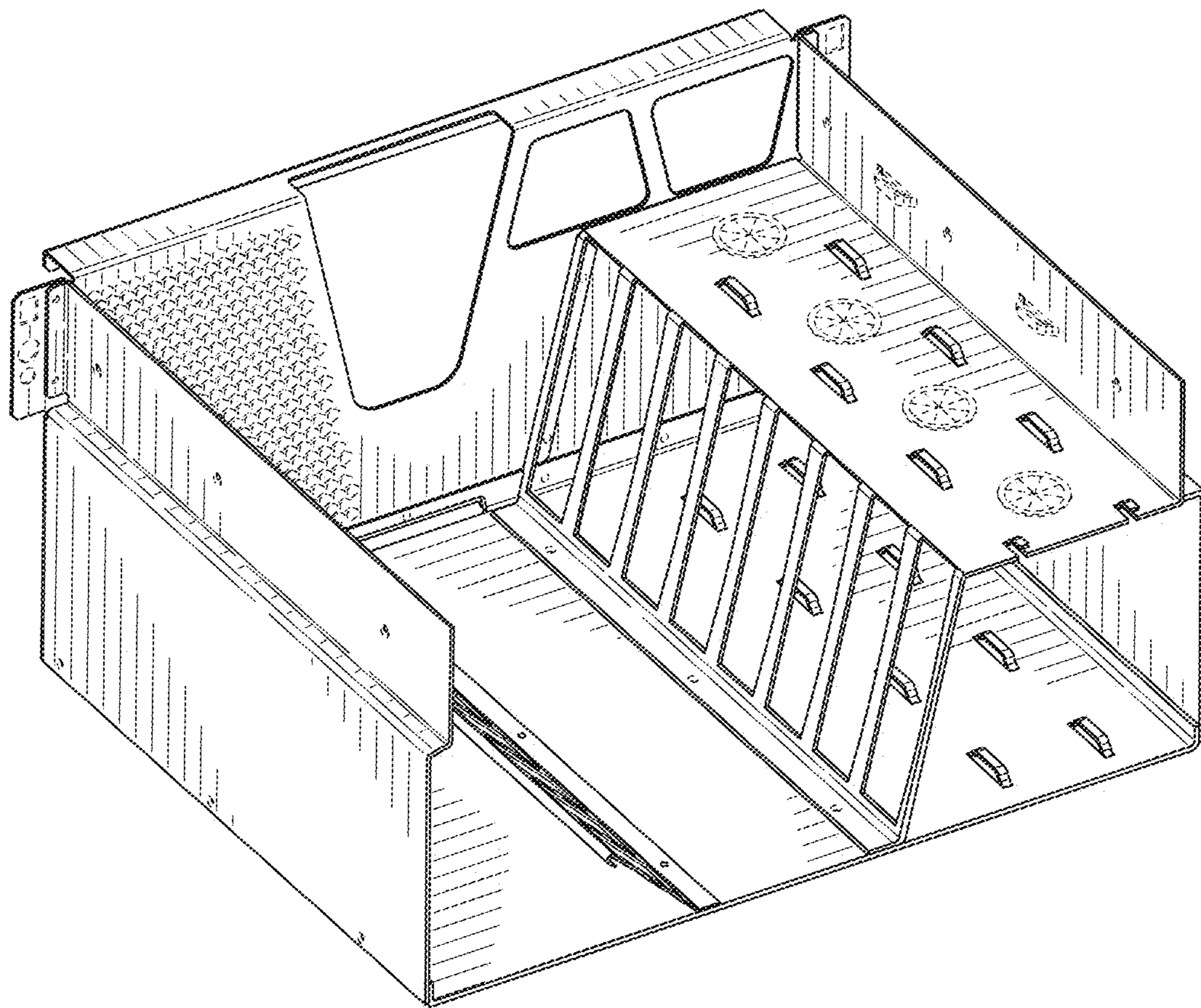

FIG. 9

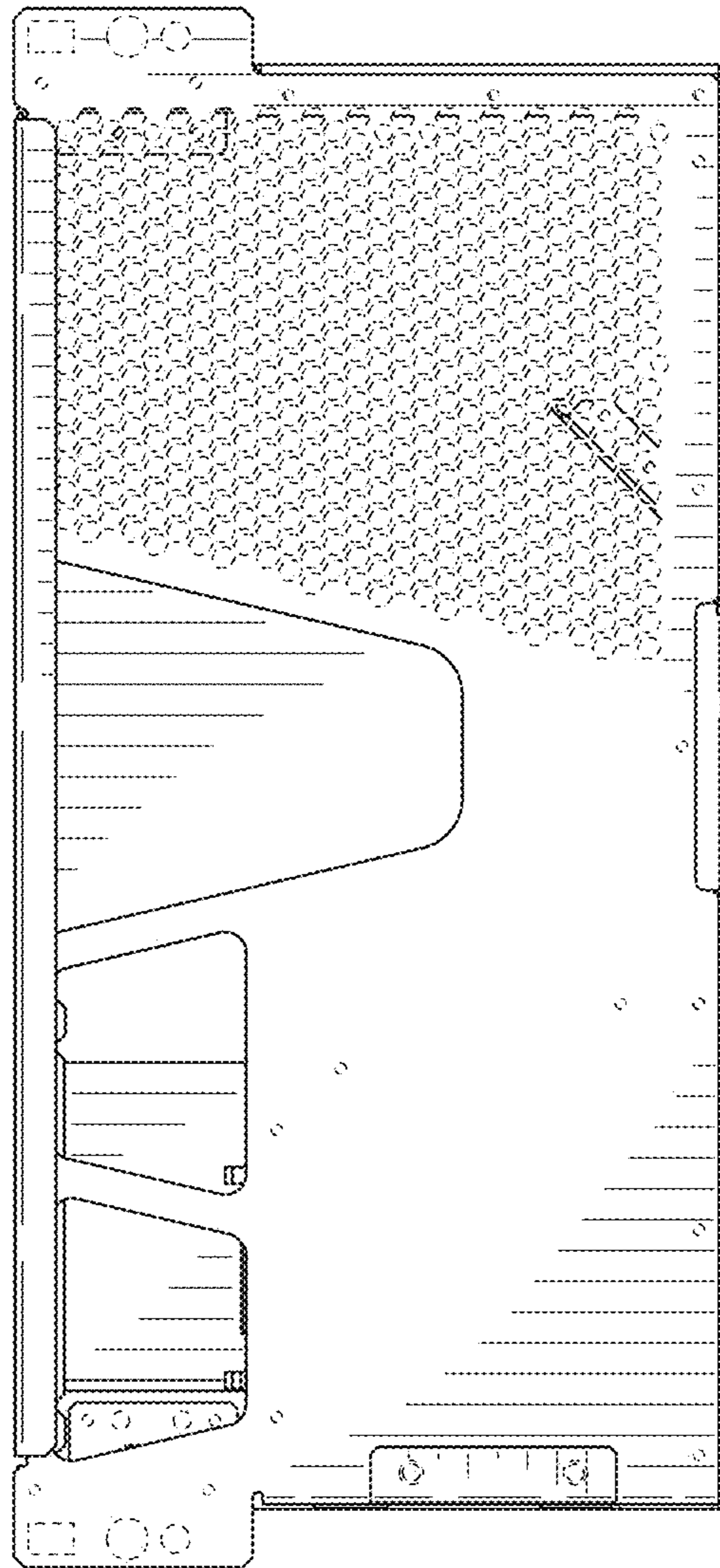

FIG. 10

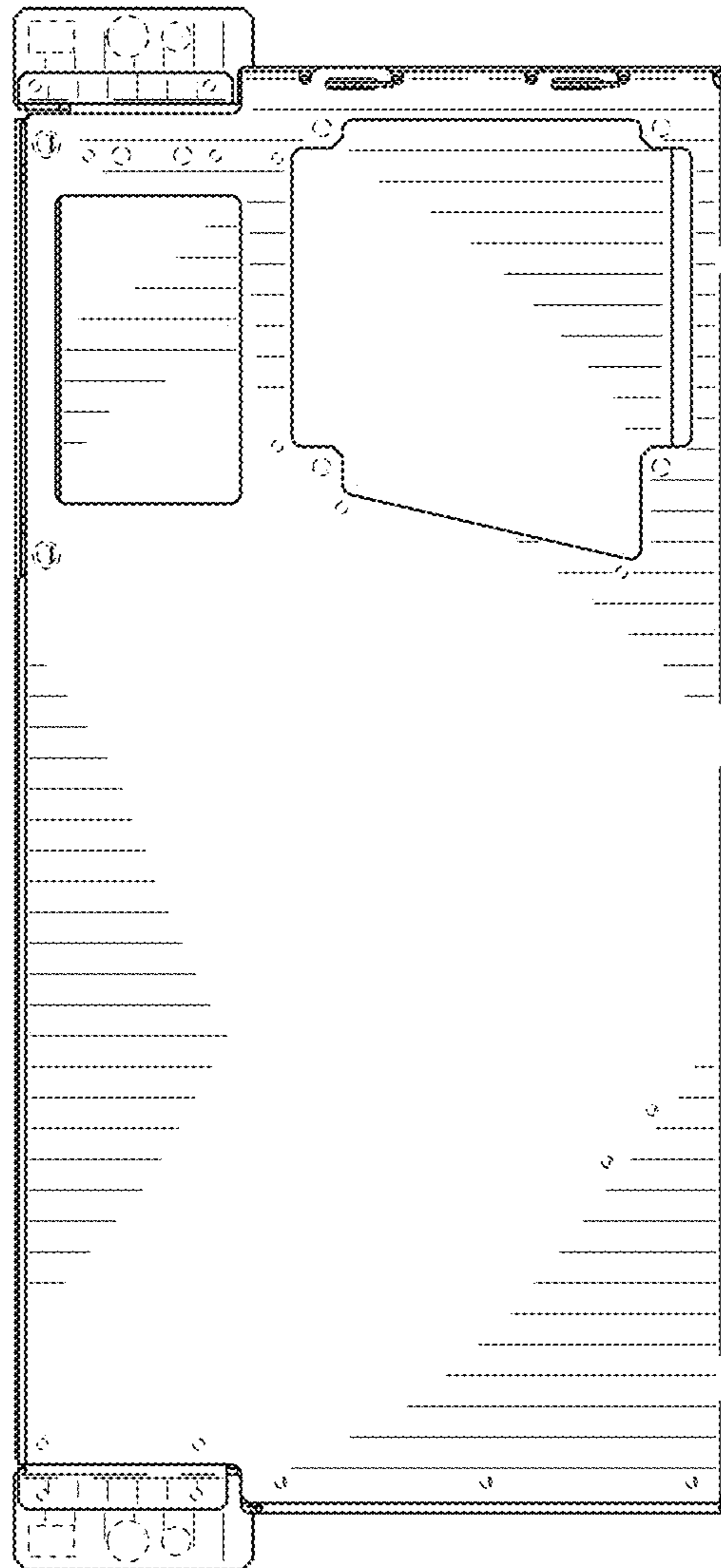

FIG. 11

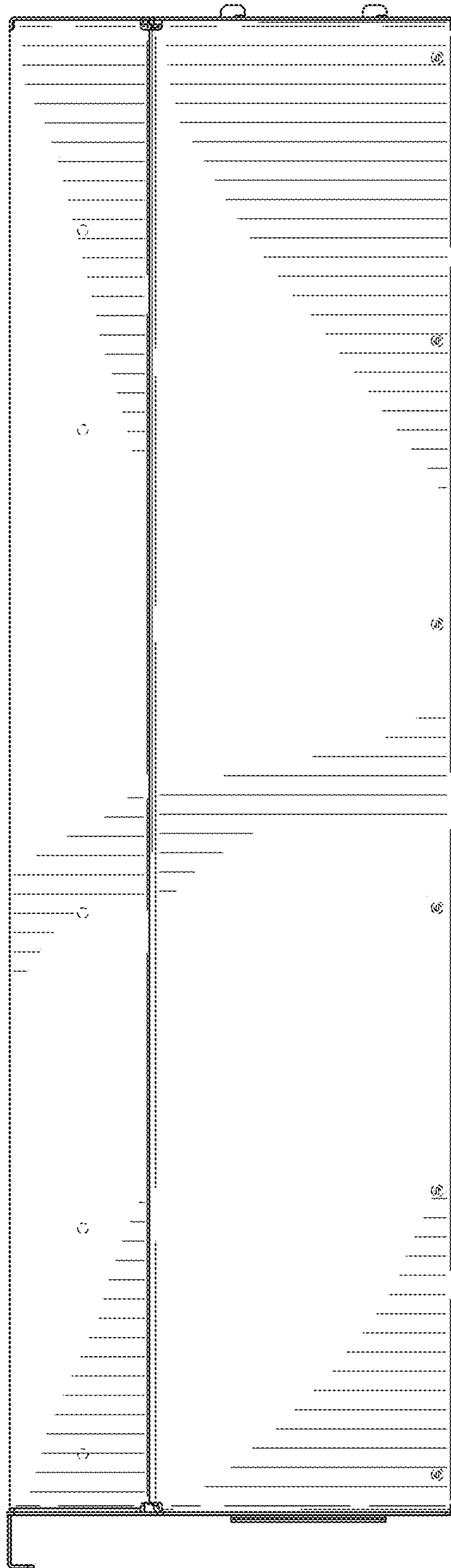

FIG. 12

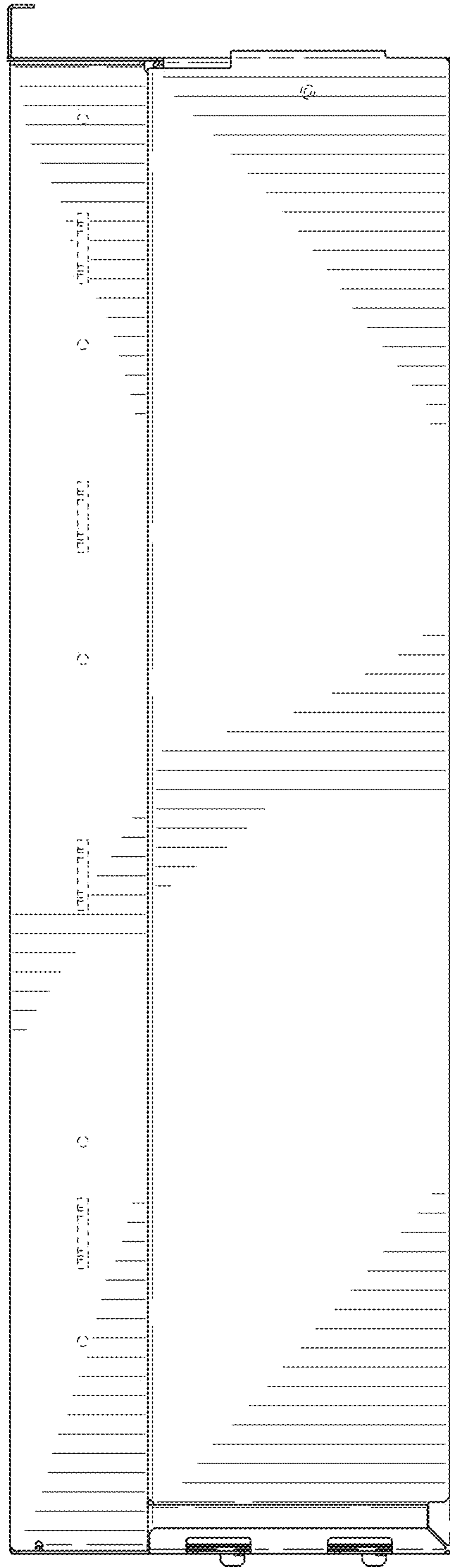

FIG. 13

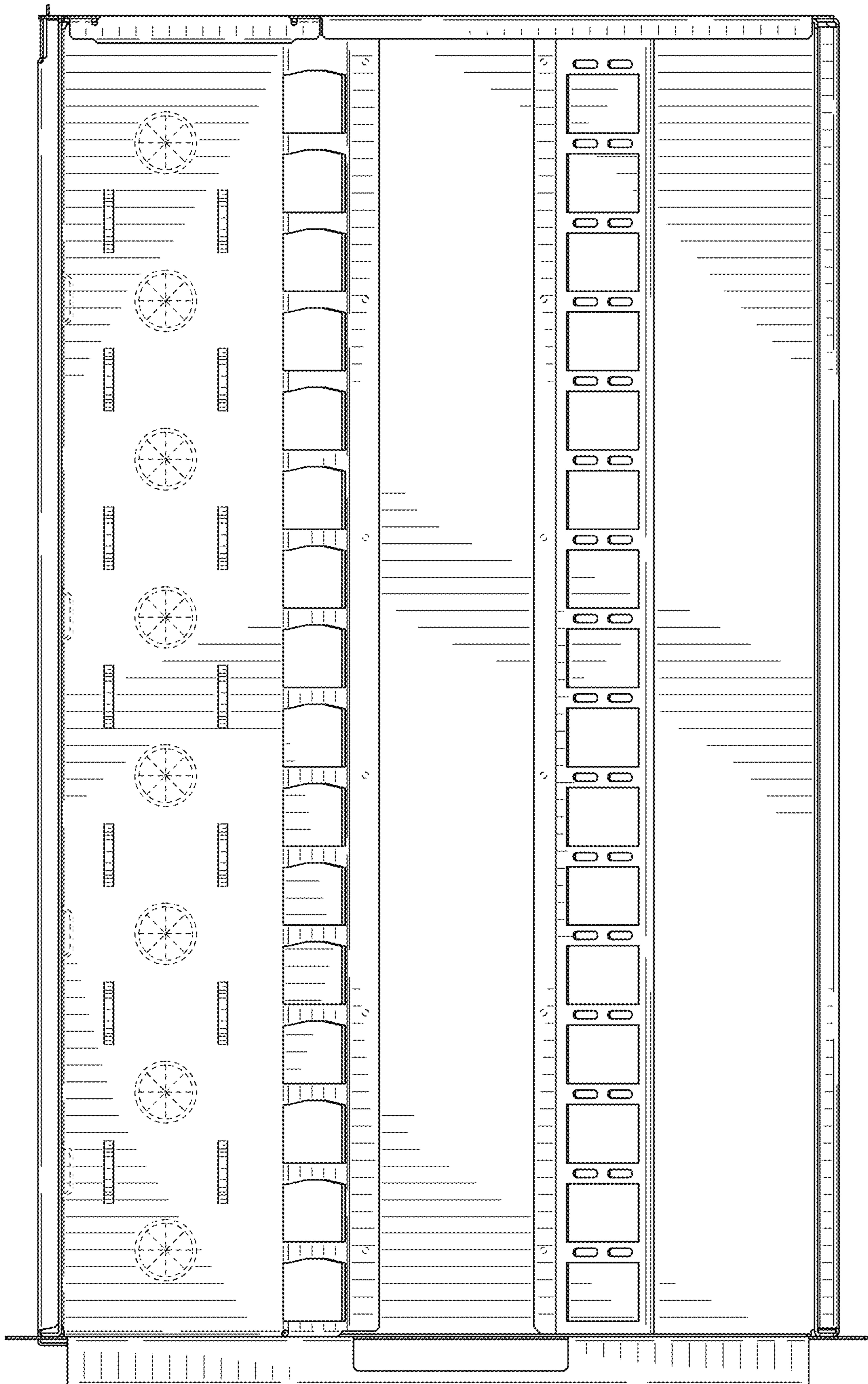

FIG. 14



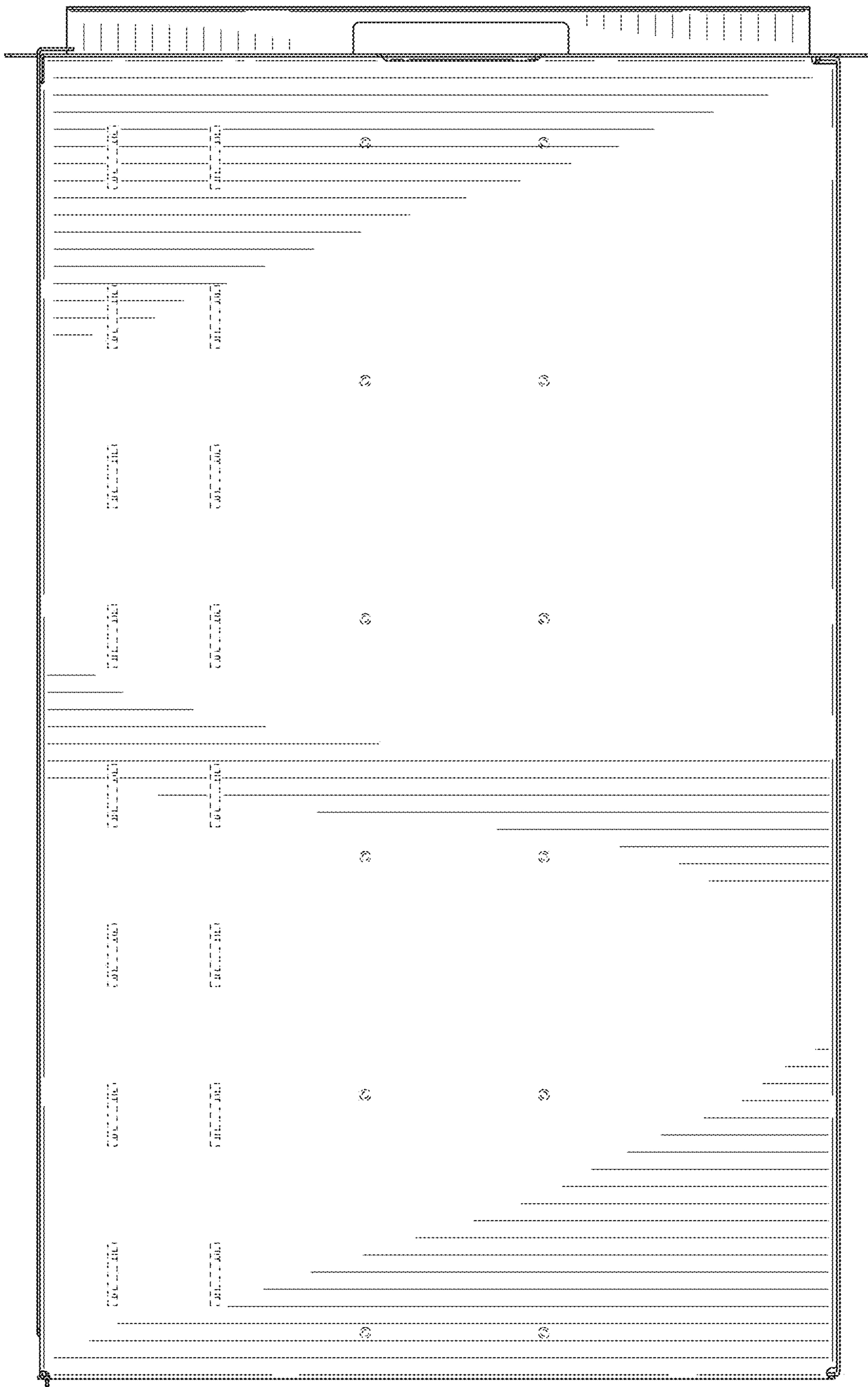

FIG. 15

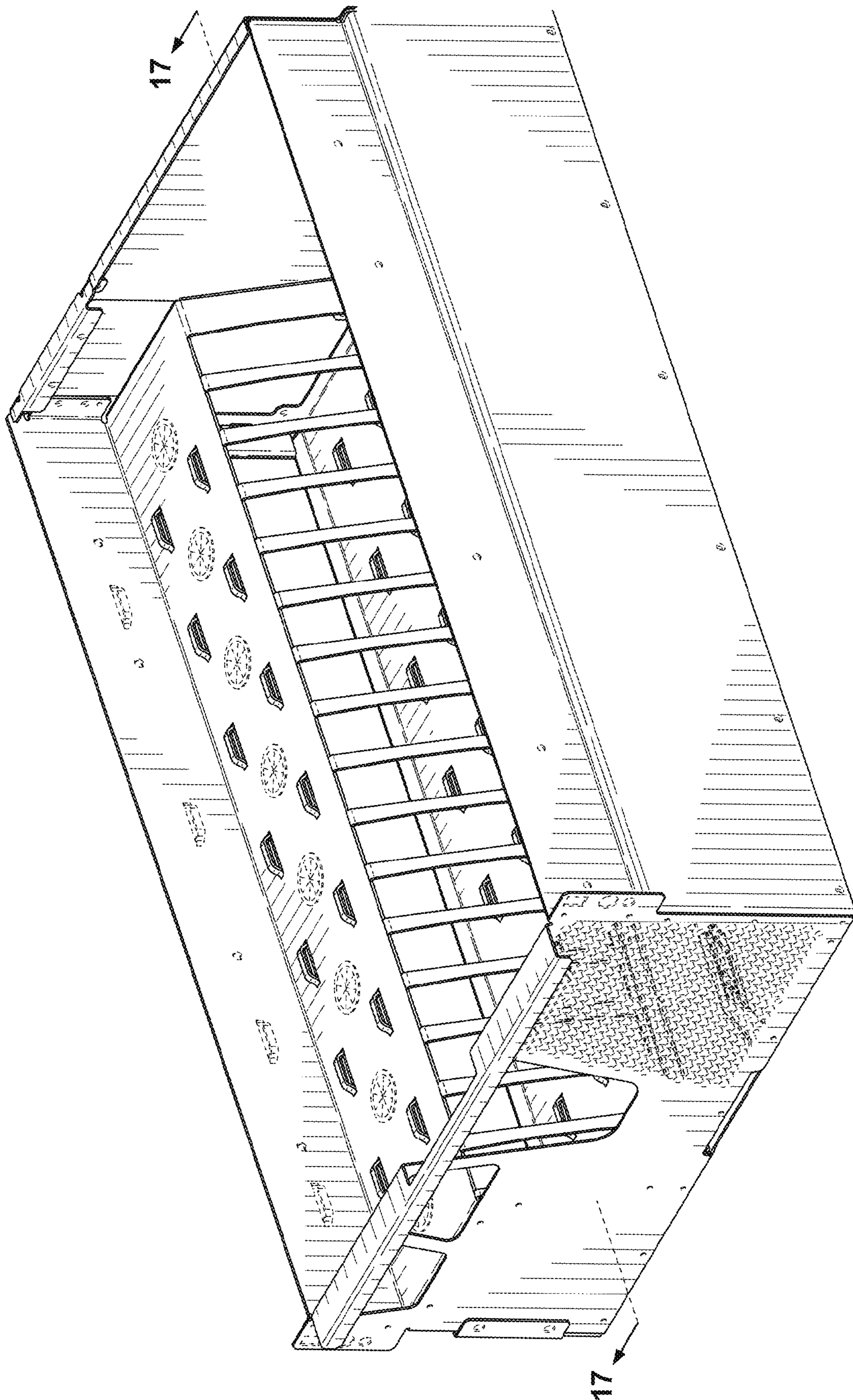

FIG. 16

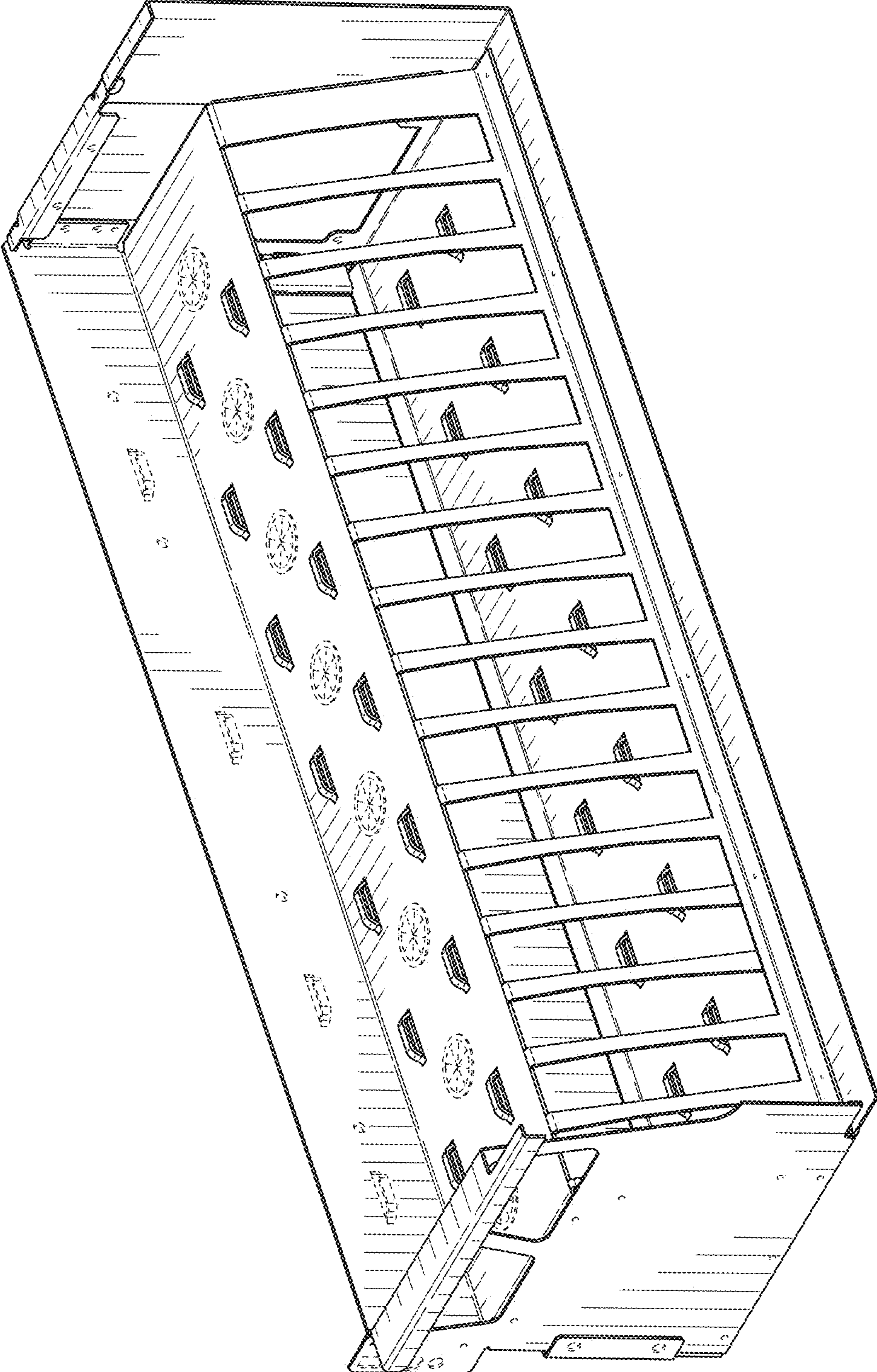

FIG. 17

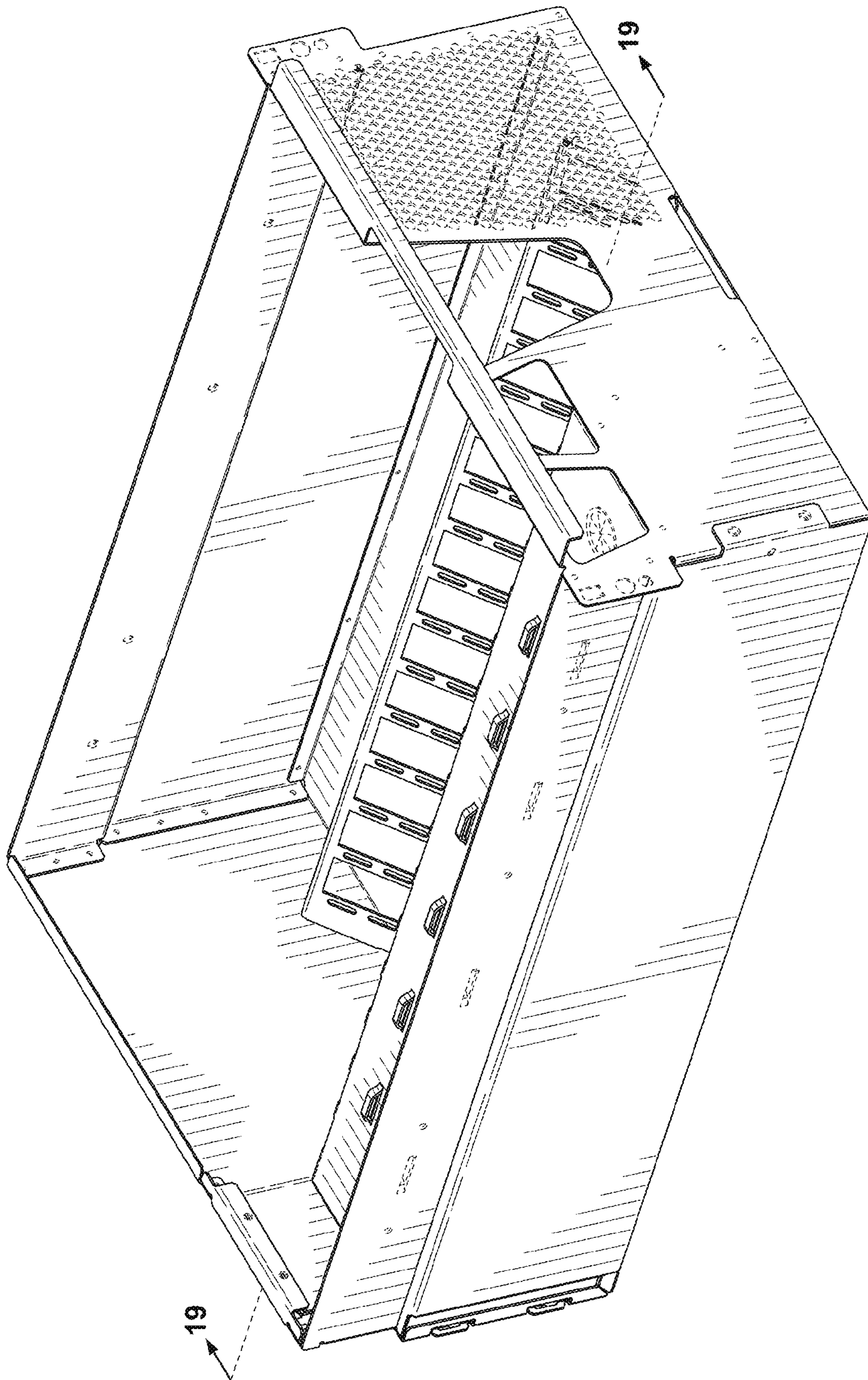

FIG. 18

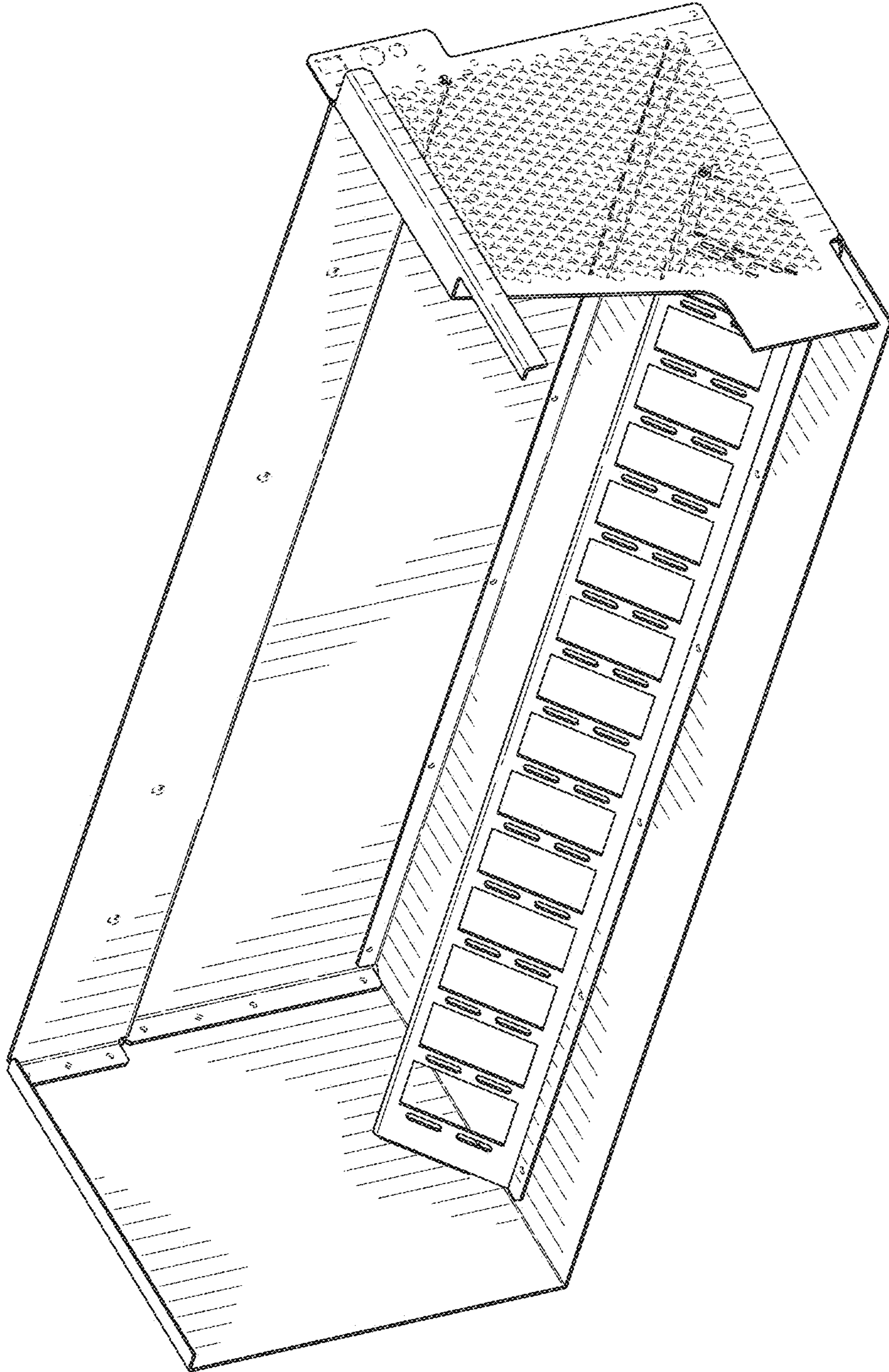

FIG. 19

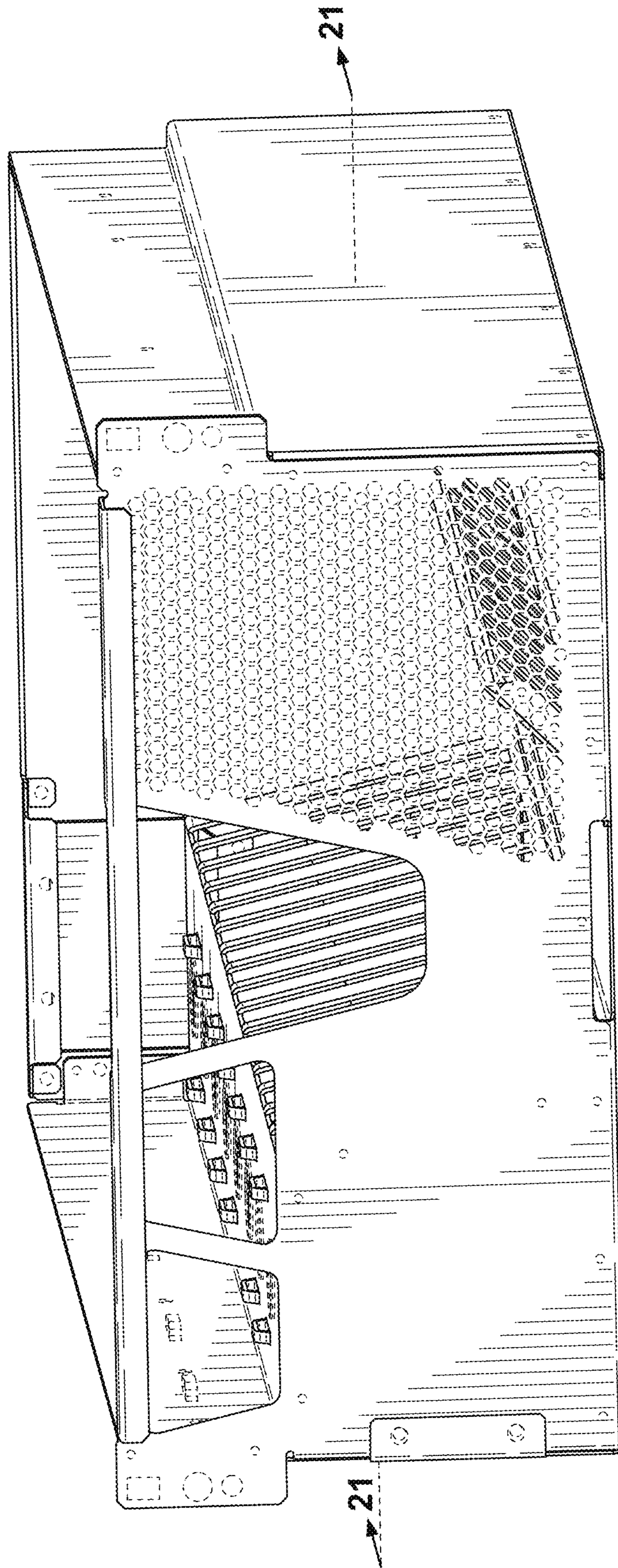

FIG. 20

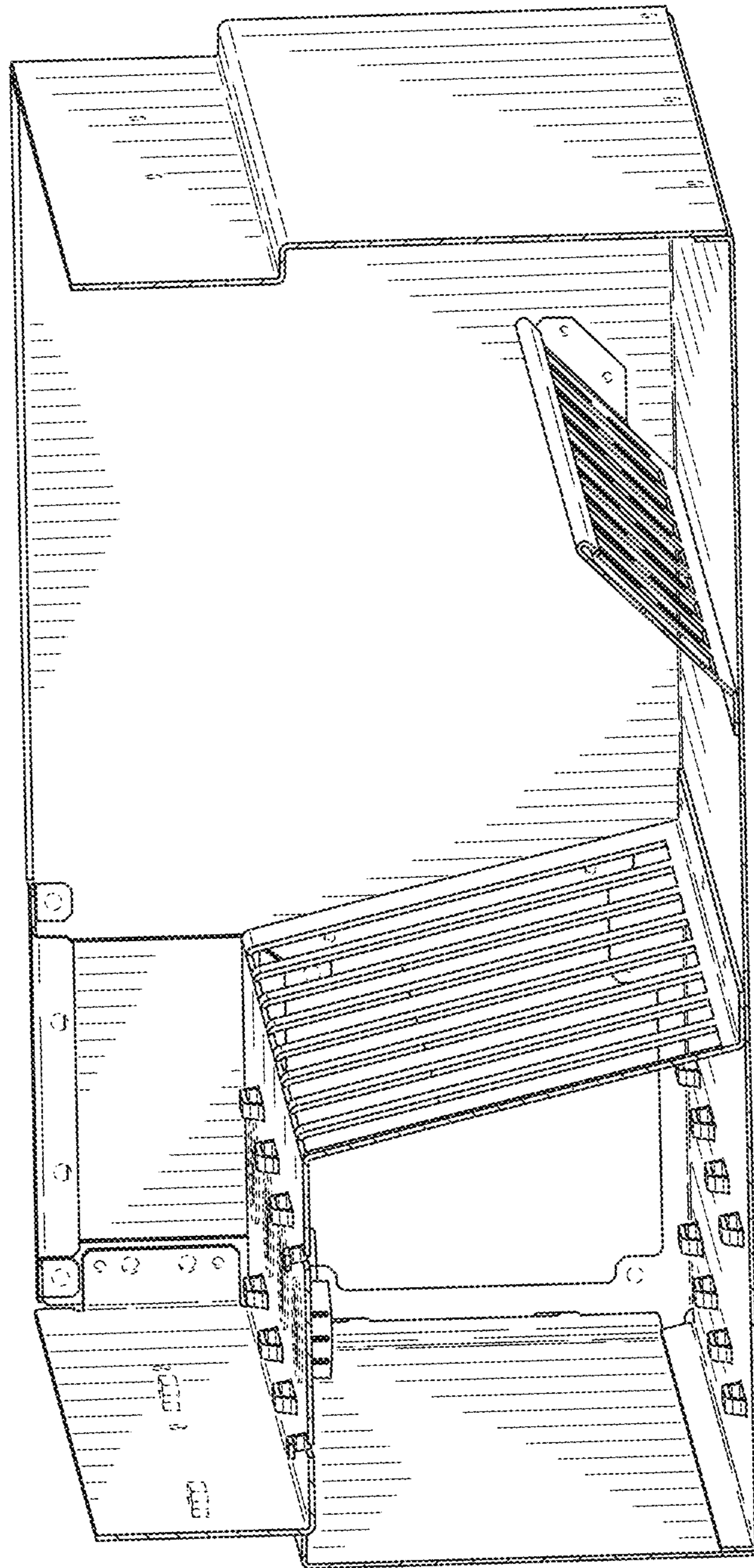

FIG. 21