



US00D913835S

(12) **United States Design Patent**
Montgomery

(10) **Patent No.:** **US D913,835 S**

(45) **Date of Patent:** **** Mar. 23, 2021**

(54) **BAND**

(71) Applicant: **Philip Richard Montgomery,**
Rochester, NY (US)

(72) Inventor: **Philip Richard Montgomery,**
Rochester, NY (US)

(**) Term: **15 Years**

(21) Appl. No.: **29/665,334**

(22) Filed: **Oct. 2, 2018**

(51) **LOC (13) Cl.** **11-01**

(52) **U.S. Cl.**
USPC **D11/2; D28/41**

(58) **Field of Classification Search**
USPC D11/1-12; D28/41; D2/865, 881
CPC A41F 9/00; A45D 8/00; A45D 8/36; A44C
5/00; A44C 5/0007; A44C 5/0015; A44C
5/0023; A44C 5/003; A44C 5/0053
See application file for complete search history.

(56) **References Cited**

U.S. PATENT DOCUMENTS

D779,120	S *	2/2017	Cull	D28/41
D779,991	S *	2/2017	Lemker	D11/3
D811,657	S *	2/2018	Lalonde	D28/41
D859,742	S *	9/2019	Harrel	D28/41
D867,660	S *	11/2019	Thillet	D28/41
10,736,386	B1 *	8/2020	Hutchins	A44C 5/0053
2005/0061345	A1 *	3/2005	Srivastava	A45D 8/36 132/200
2007/0094768	A1 *	5/2007	Moudgill	A45D 8/36 2/171

(Continued)

Primary Examiner — Llorelys Martinez

(74) *Attorney, Agent, or Firm* — Tracy Jong Law Firm;
Tracy P. Jong; Cheng Ning Jong

(57) **CLAIM**

The ornamental design for a band, as shown and described.

DESCRIPTION

FIG. 1 is a top front perspective of a first embodiment of a band showing my new design;
 FIG. 2 is another top front perspective view thereof;
 FIG. 3 is a top rear view thereof;
 FIG. 4 is a top view thereof;
 FIG. 5 is a bottom view thereof;
 FIG. 6 is a front view thereof;
 FIG. 7 is a right side view thereof;
 FIG. 8 is a rear view thereof;
 FIG. 9 is a rear view thereof;
 FIG. 10 is a left side view thereof;
 FIG. 11 is a front bottom view of the band, shown in a configuration of use;
 FIG. 12 is a left side view of the band, shown in a configuration of use.
 FIG. 13 is a top front perspective of a second embodiment of a band showing my new design;
 FIG. 14 is a top rear view thereof;
 FIG. 15 is a top view thereof;
 FIG. 16 is a bottom view thereof;
 FIG. 17 is a front view thereof;
 FIG. 18 is a right side view thereof;
 FIG. 19 is a rear view thereof;
 FIG. 20 is a rear view thereof;
 FIG. 21 is a left side view thereof;
 FIG. 22 is a front view of the band, shown in a configuration of use; and,
 FIG. 23 is a view of the present band in use thereof.
 The broken lines shown in FIG. 2 represent portions of the band that form no part of the claimed design. The diagonal dashed lines shown along the band represent stitching that forms part of the claim. The other broken lines showing the text indicia reading "Lace Head" in FIGS. 9 and 20, and, a human head or hand in FIGS. 11, 12, 22 and 23 represent environmental subject matter only and form no part of the claimed design.

1 Claim, 12 Drawing Sheets

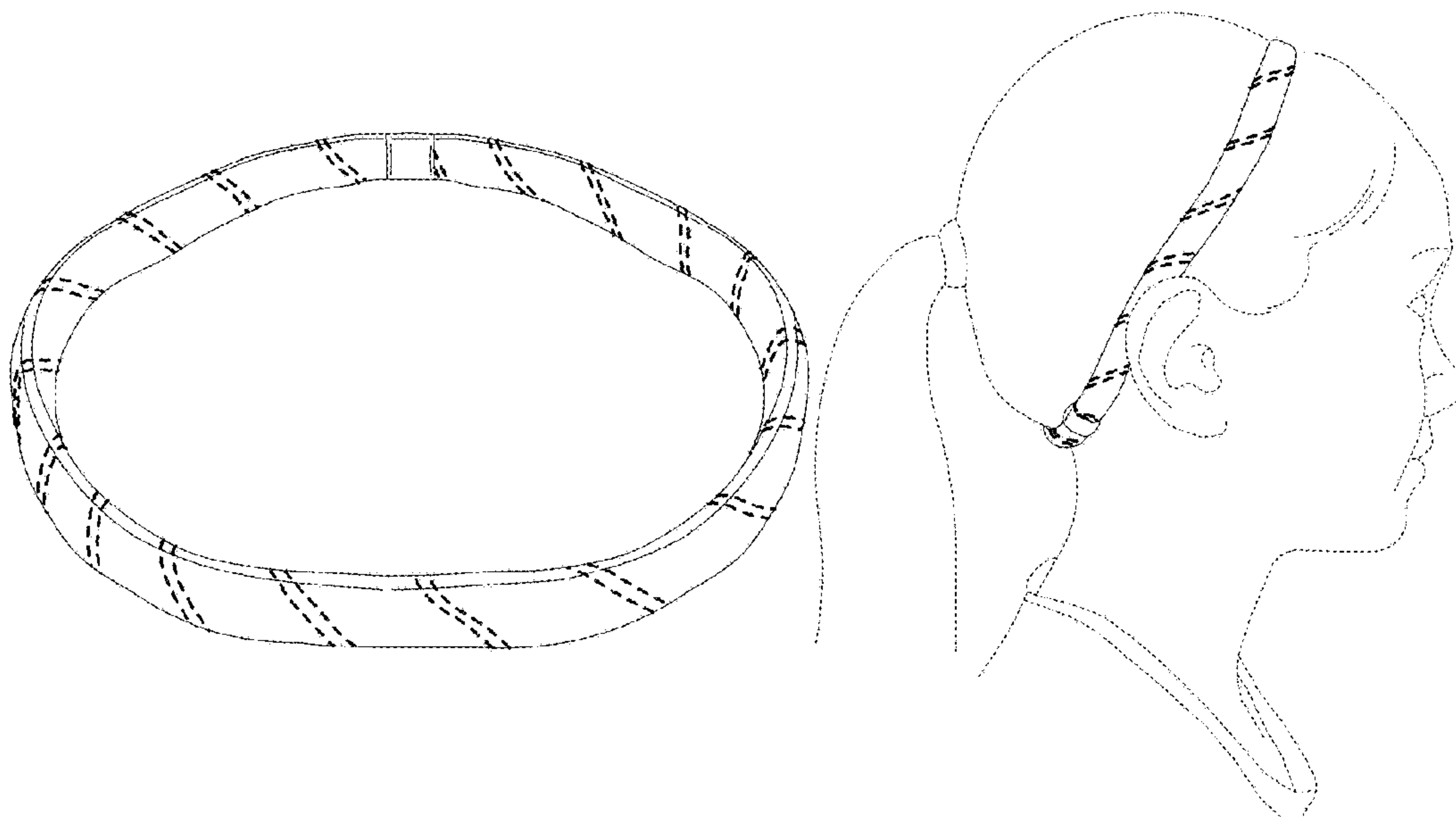

(56)

References Cited

U.S. PATENT DOCUMENTS

2015/0335124 A1* 11/2015 Passarello A45D 8/36
132/275
2020/0268083 A1* 8/2020 Gibson A45D 8/36

* cited by examiner

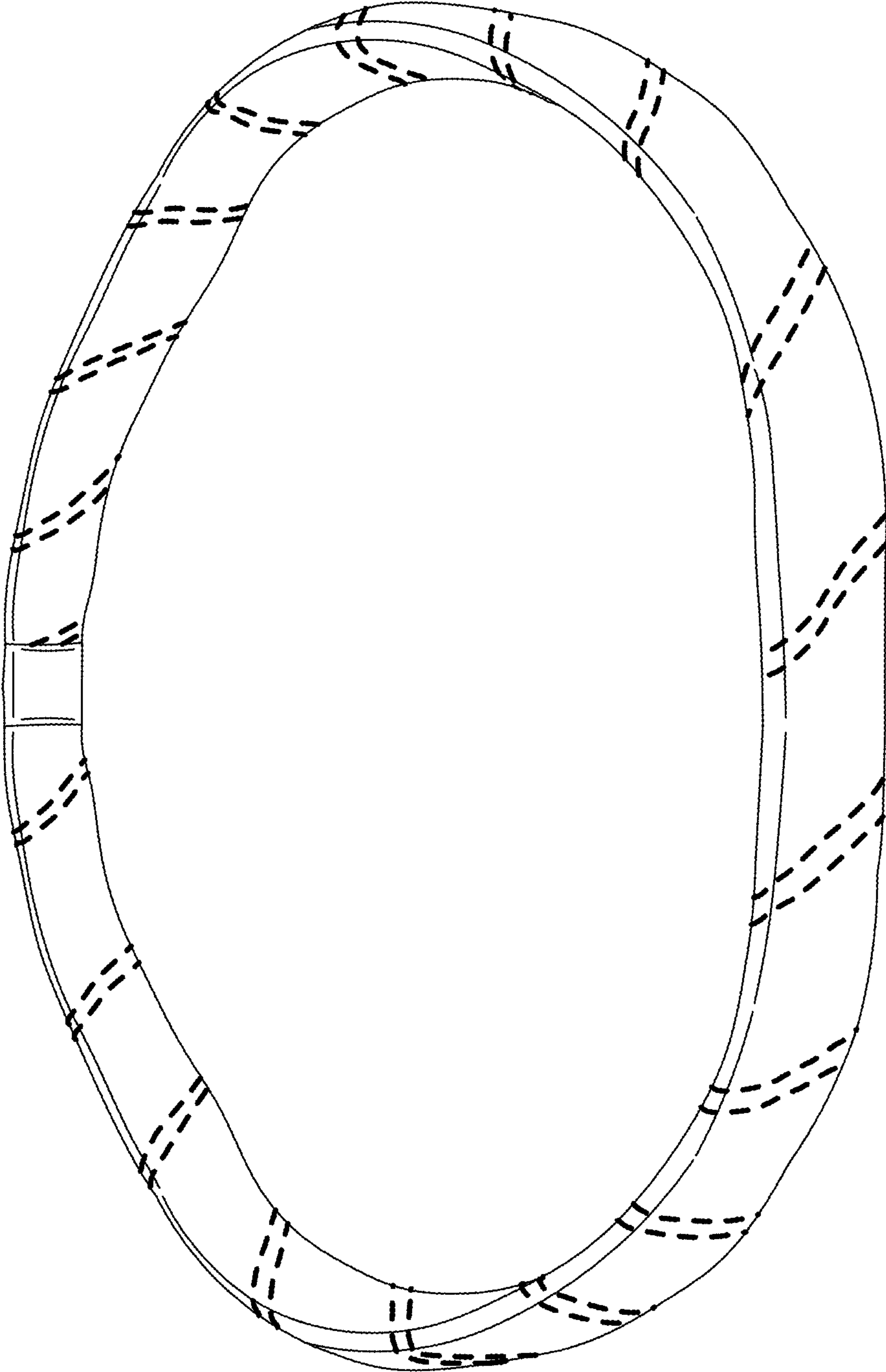

FIG. 1

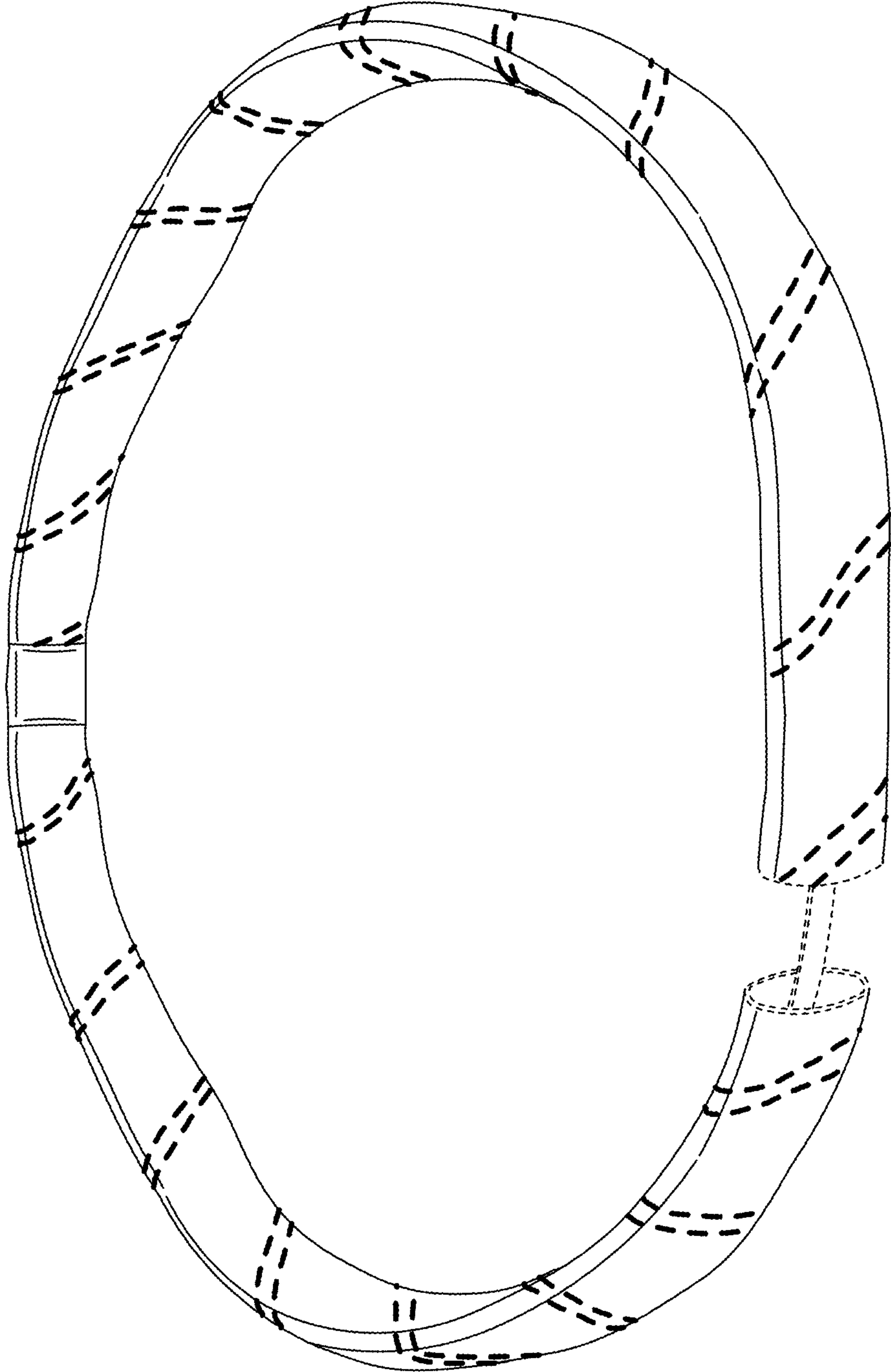

FIG. 2

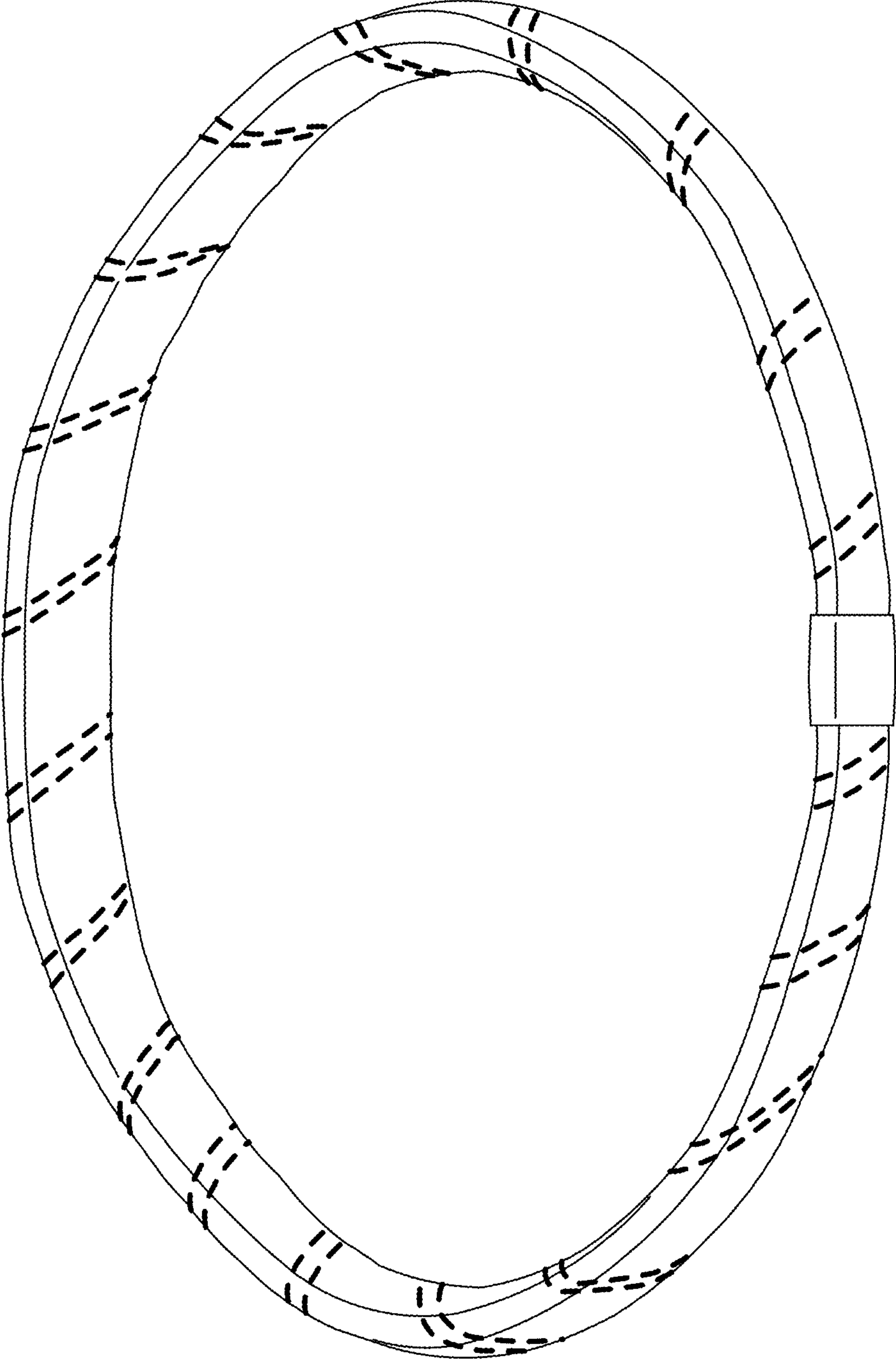

FIG. 3

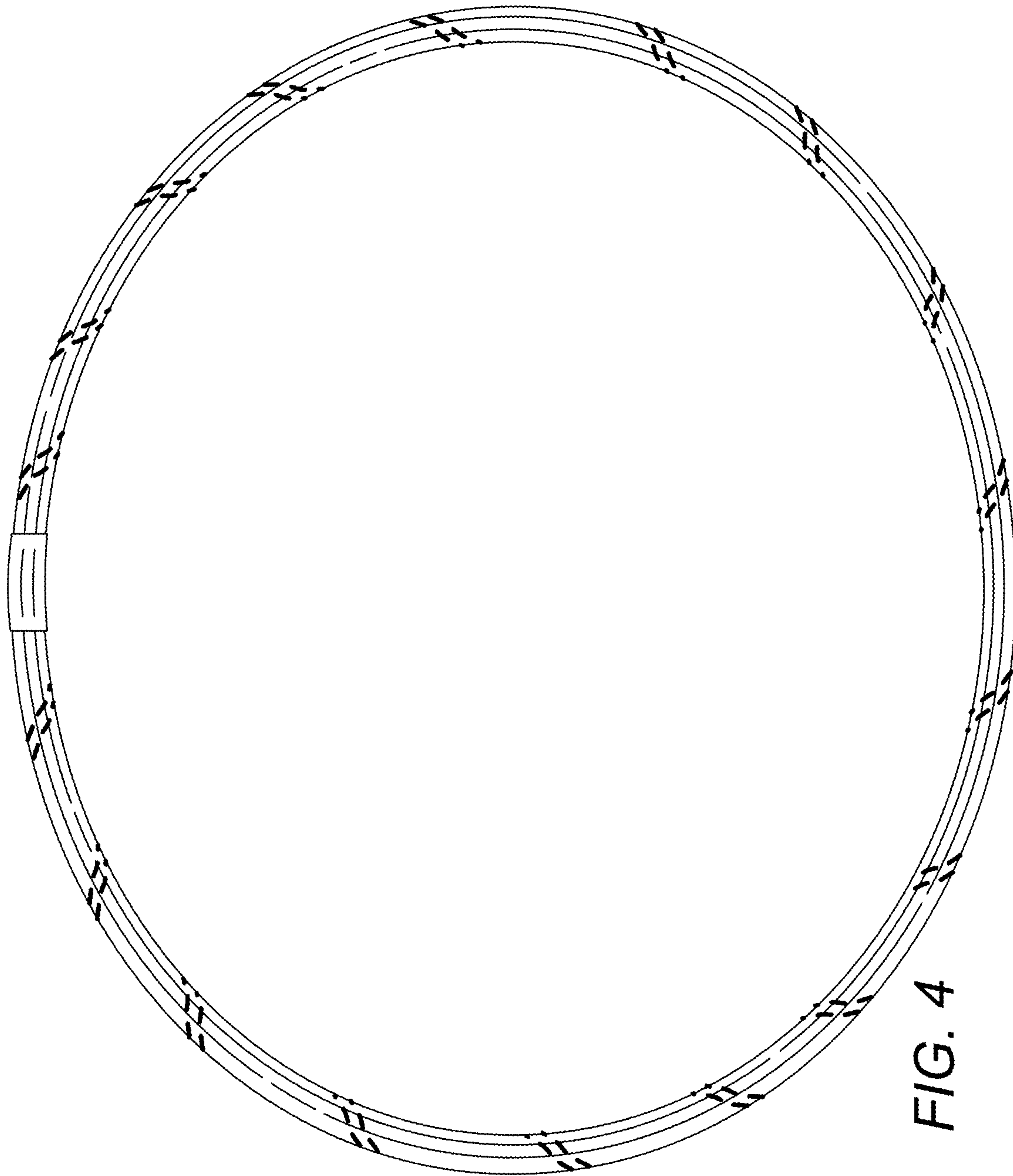
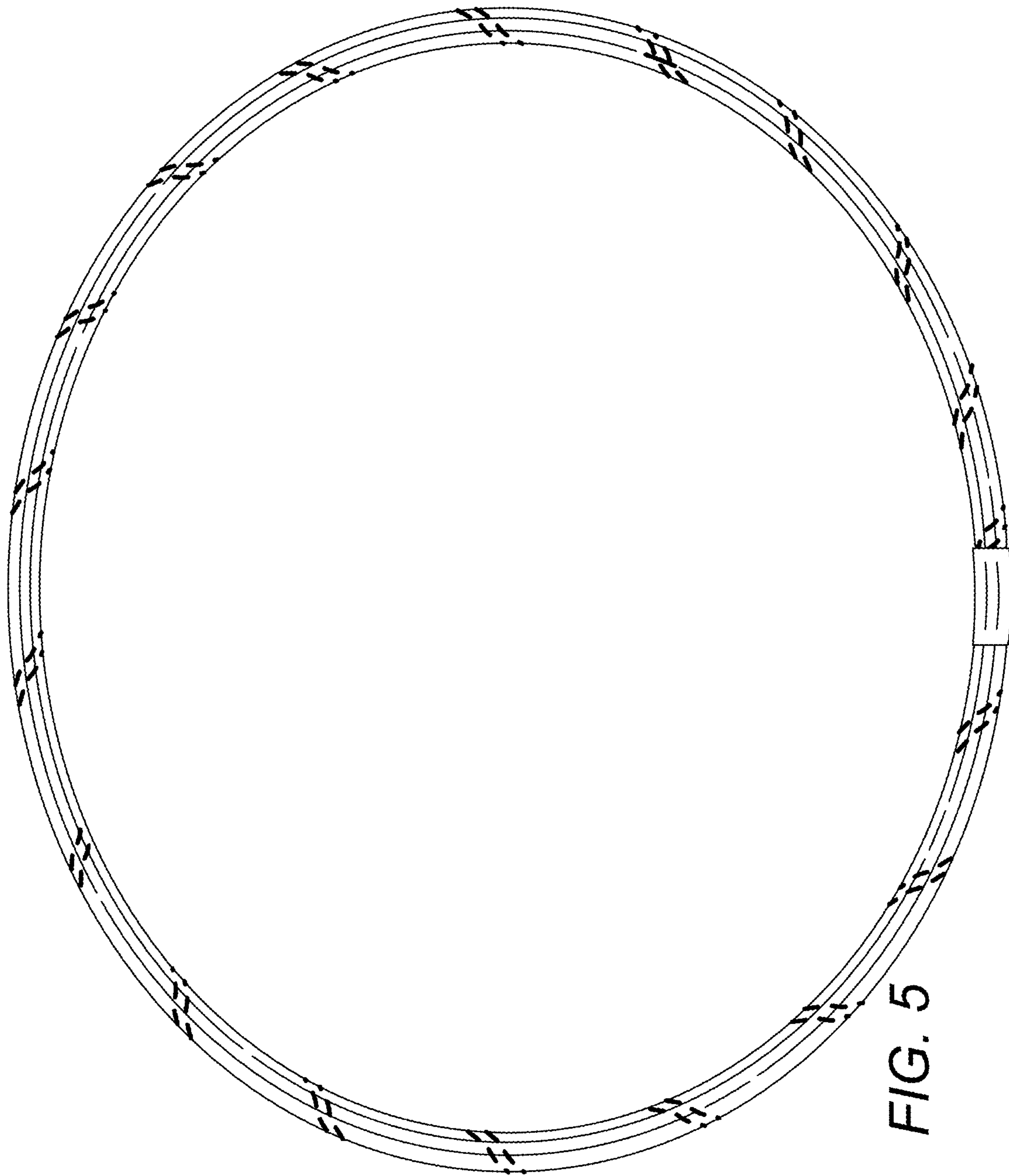

FIG. 4



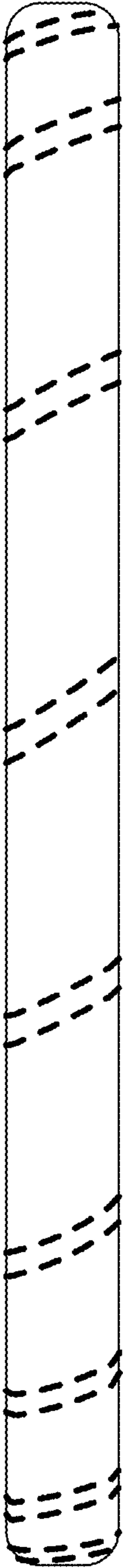

FIG. 6

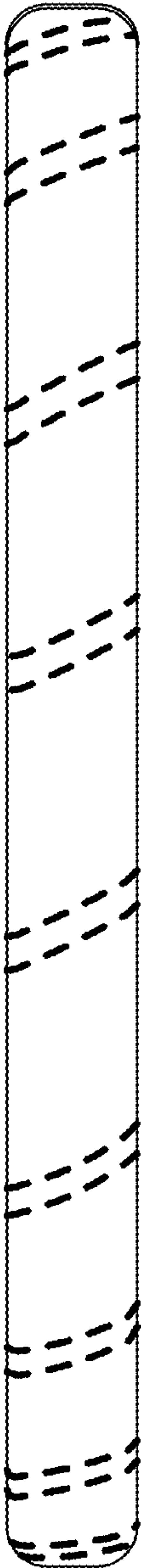

FIG. 7

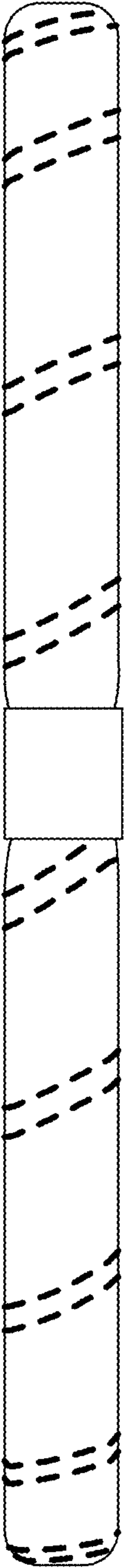

FIG. 8



FIG. 9

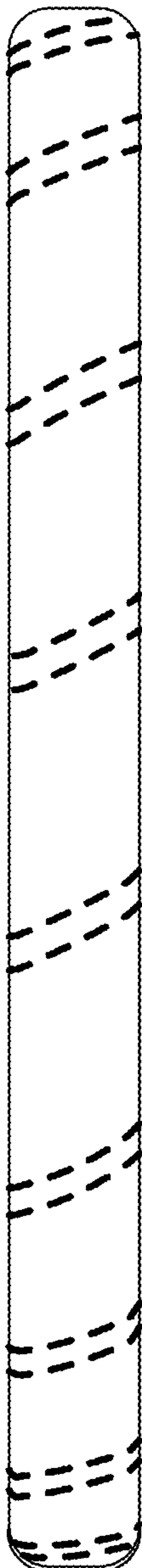

FIG. 10

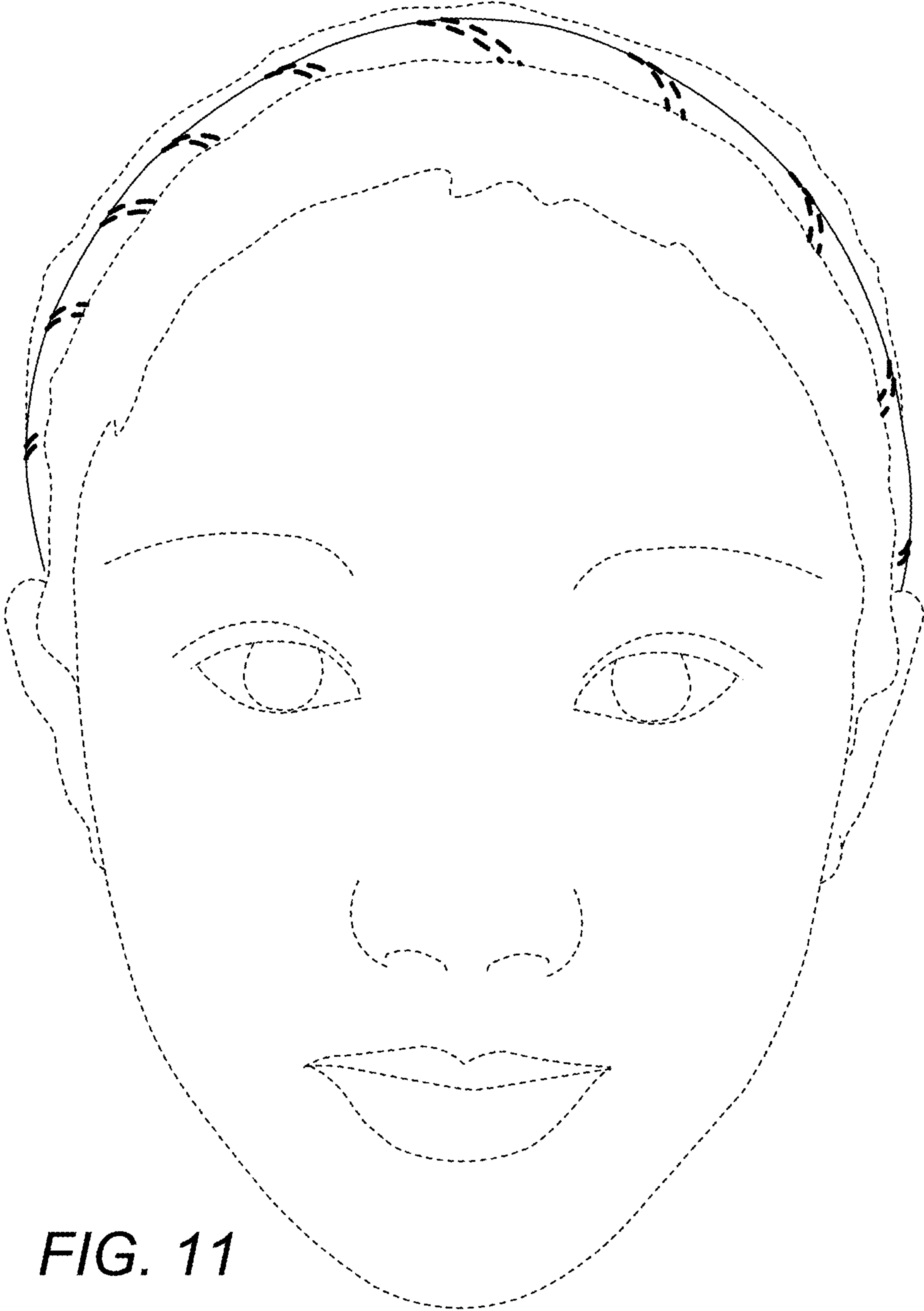

FIG. 11

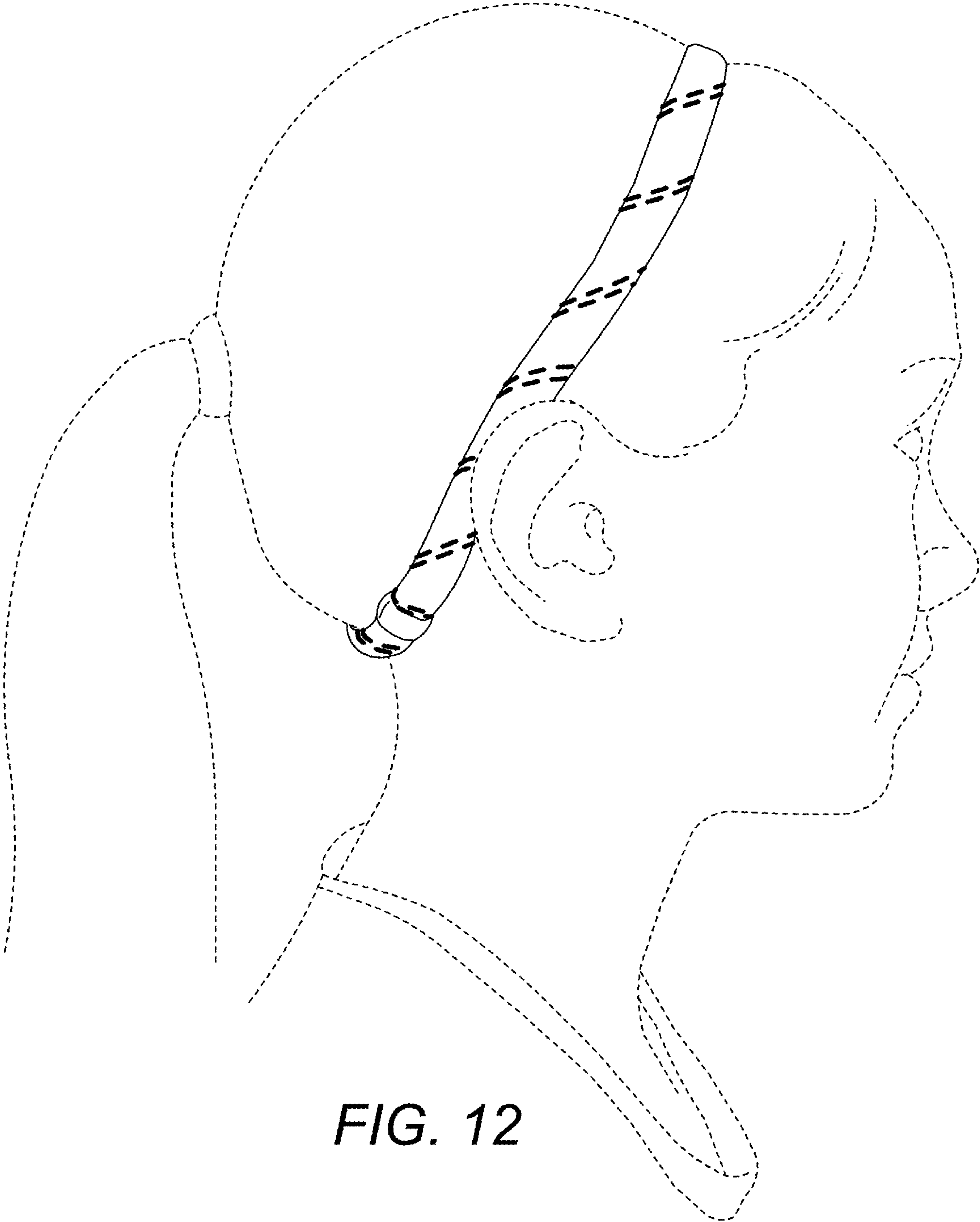

FIG. 12

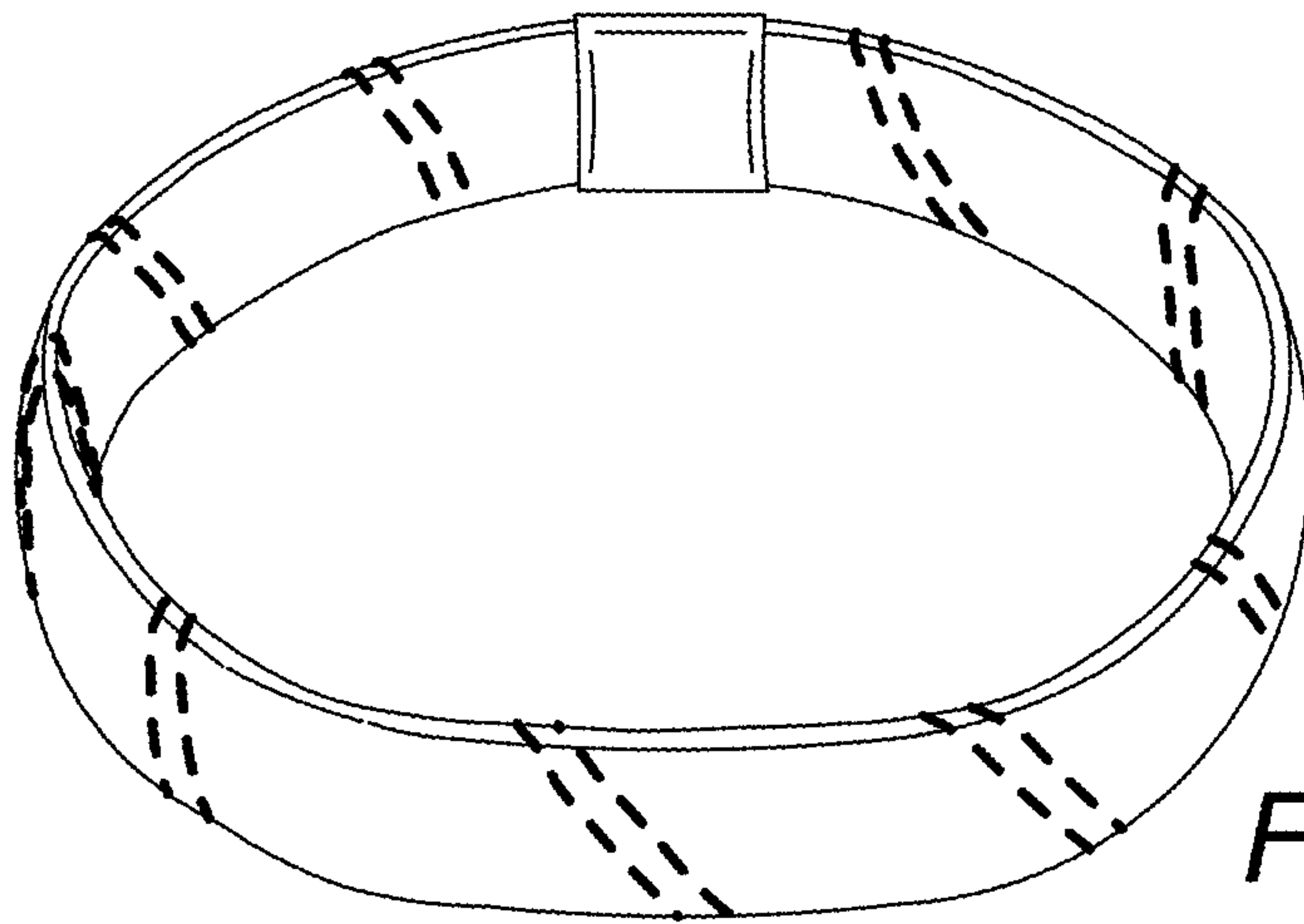

FIG. 13

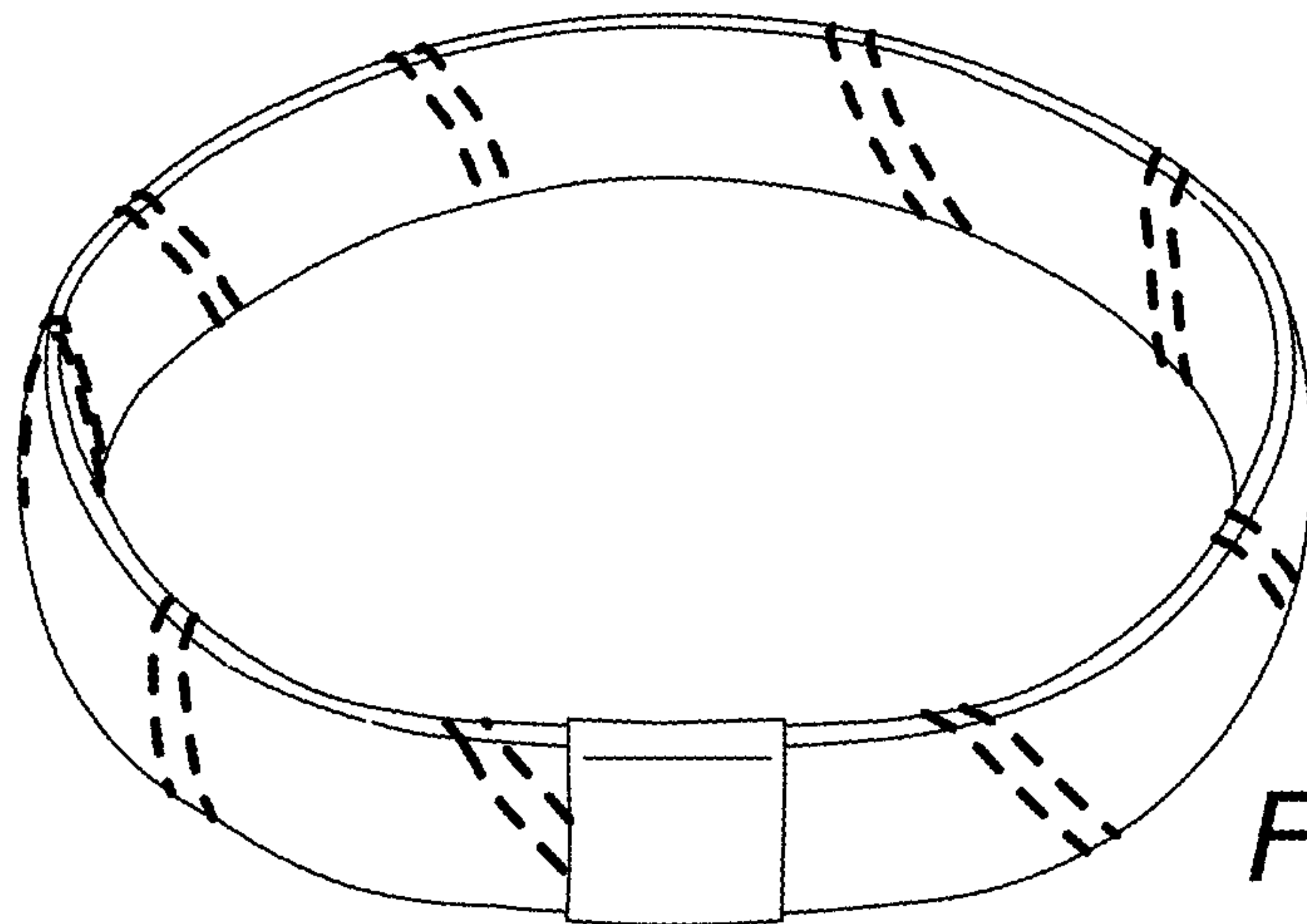

FIG. 14

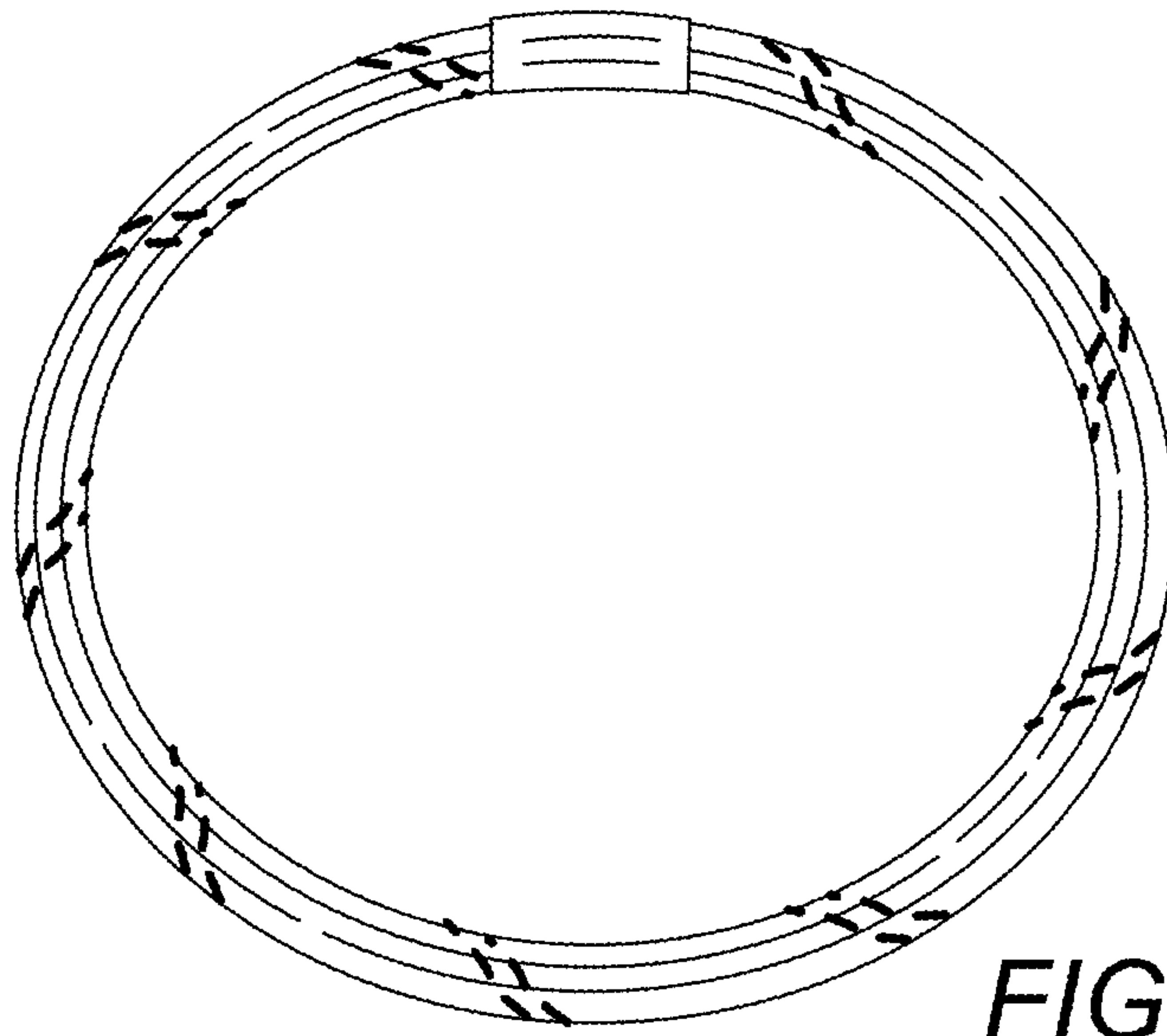

FIG. 15

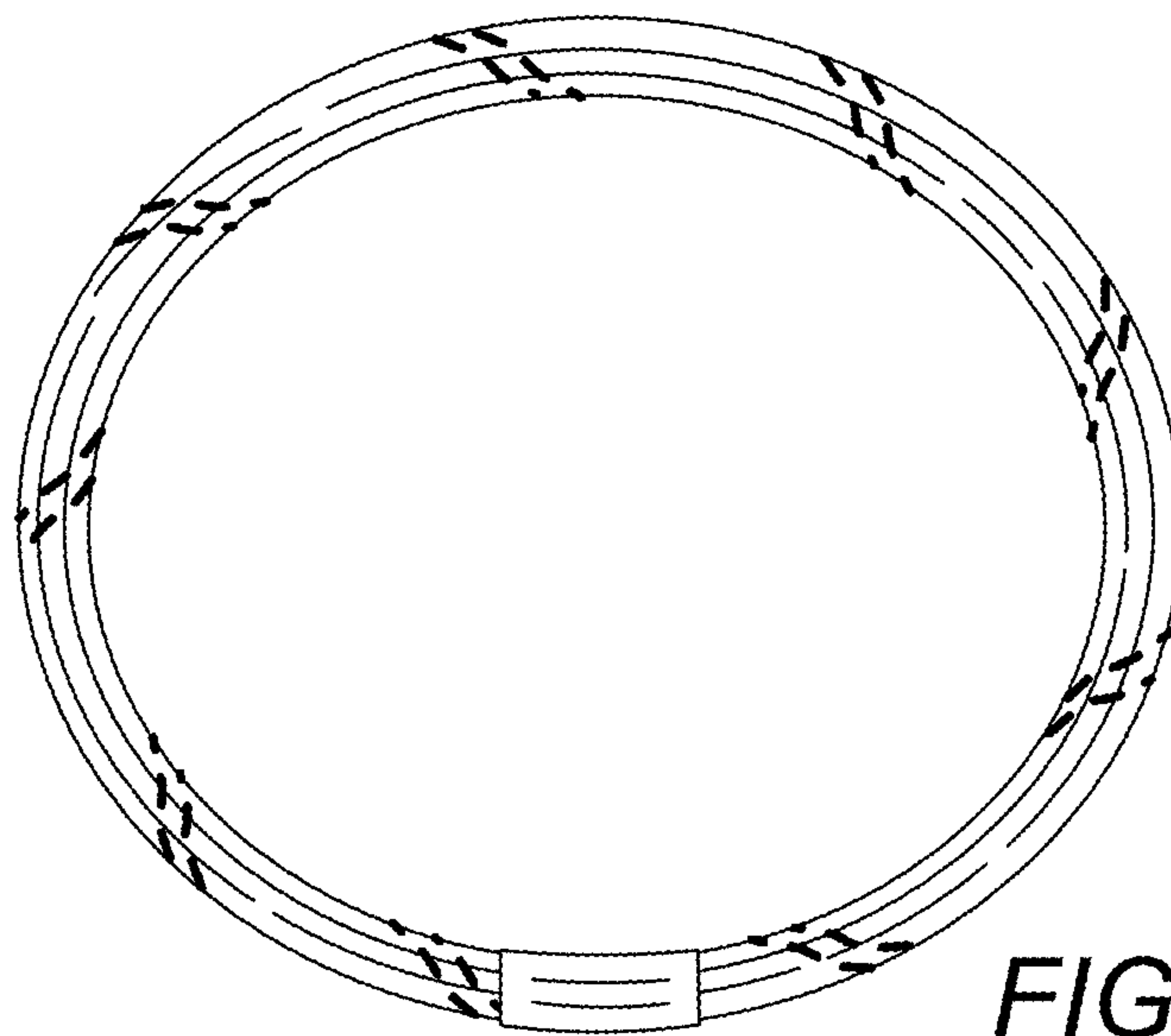

FIG. 16



FIG. 17

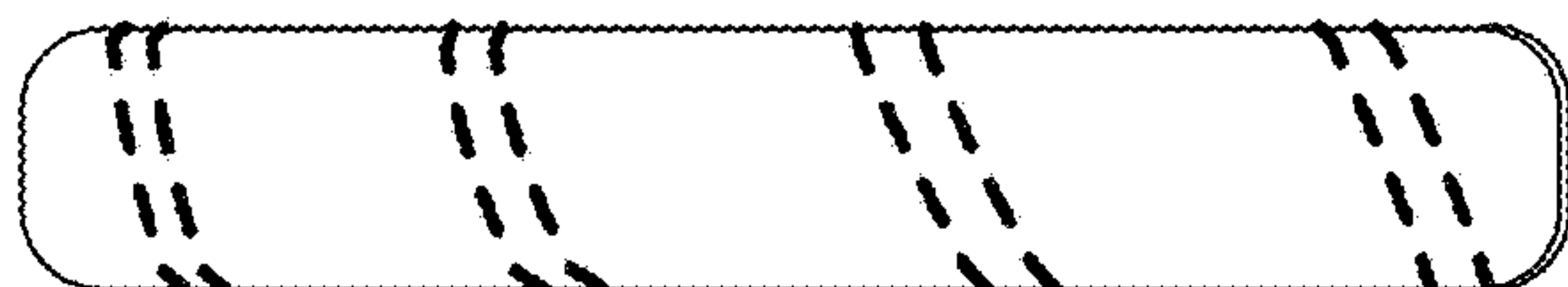

FIG. 18

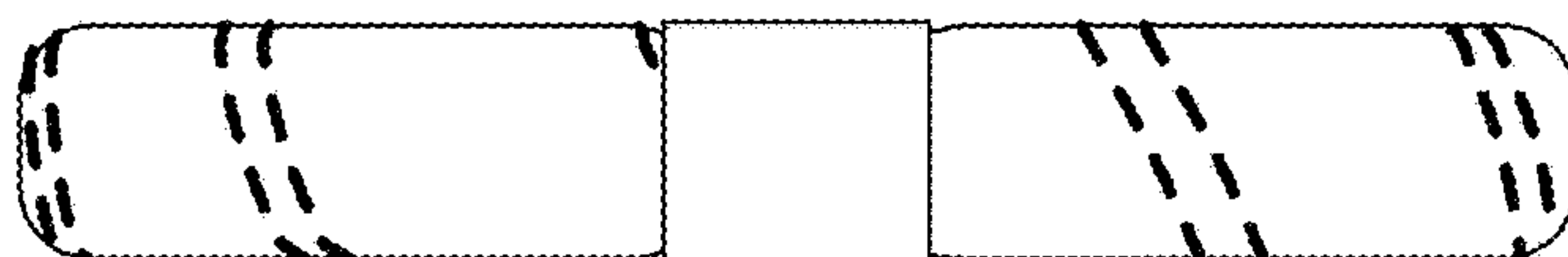

FIG. 19

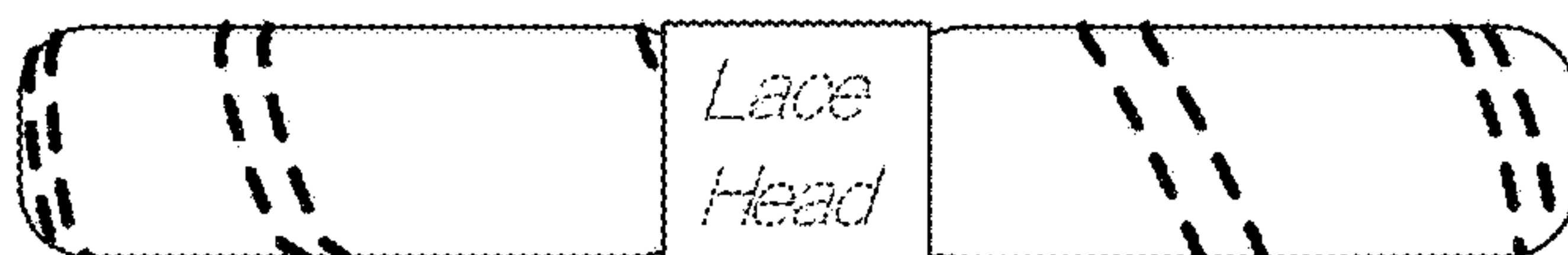

FIG. 20

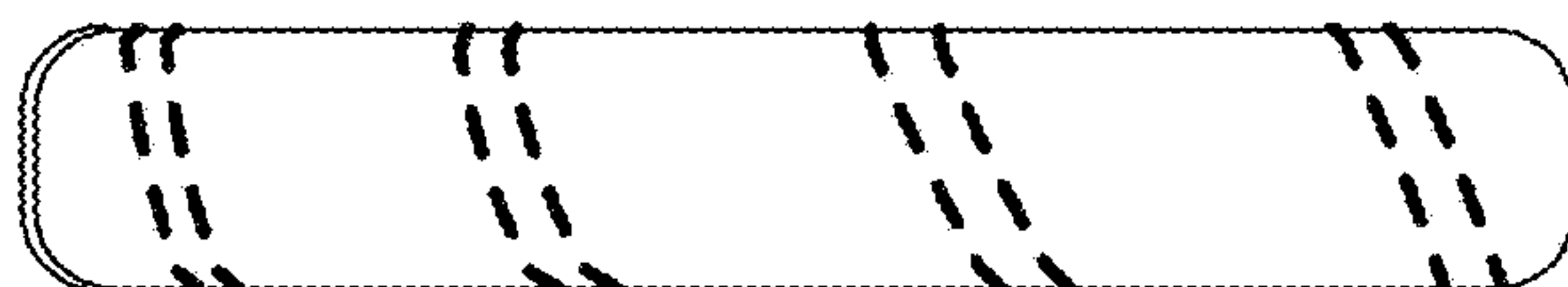

FIG. 21

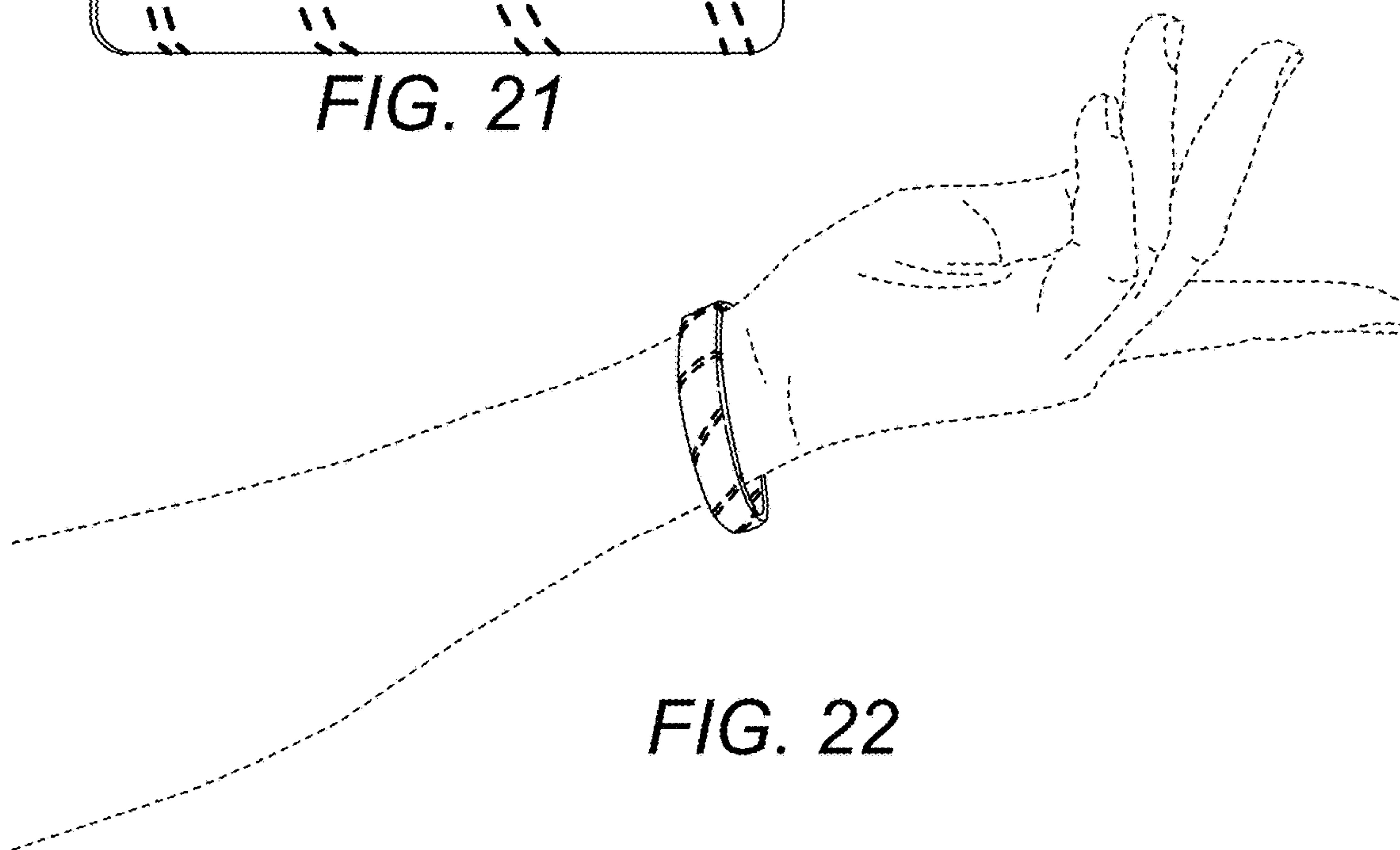

FIG. 22

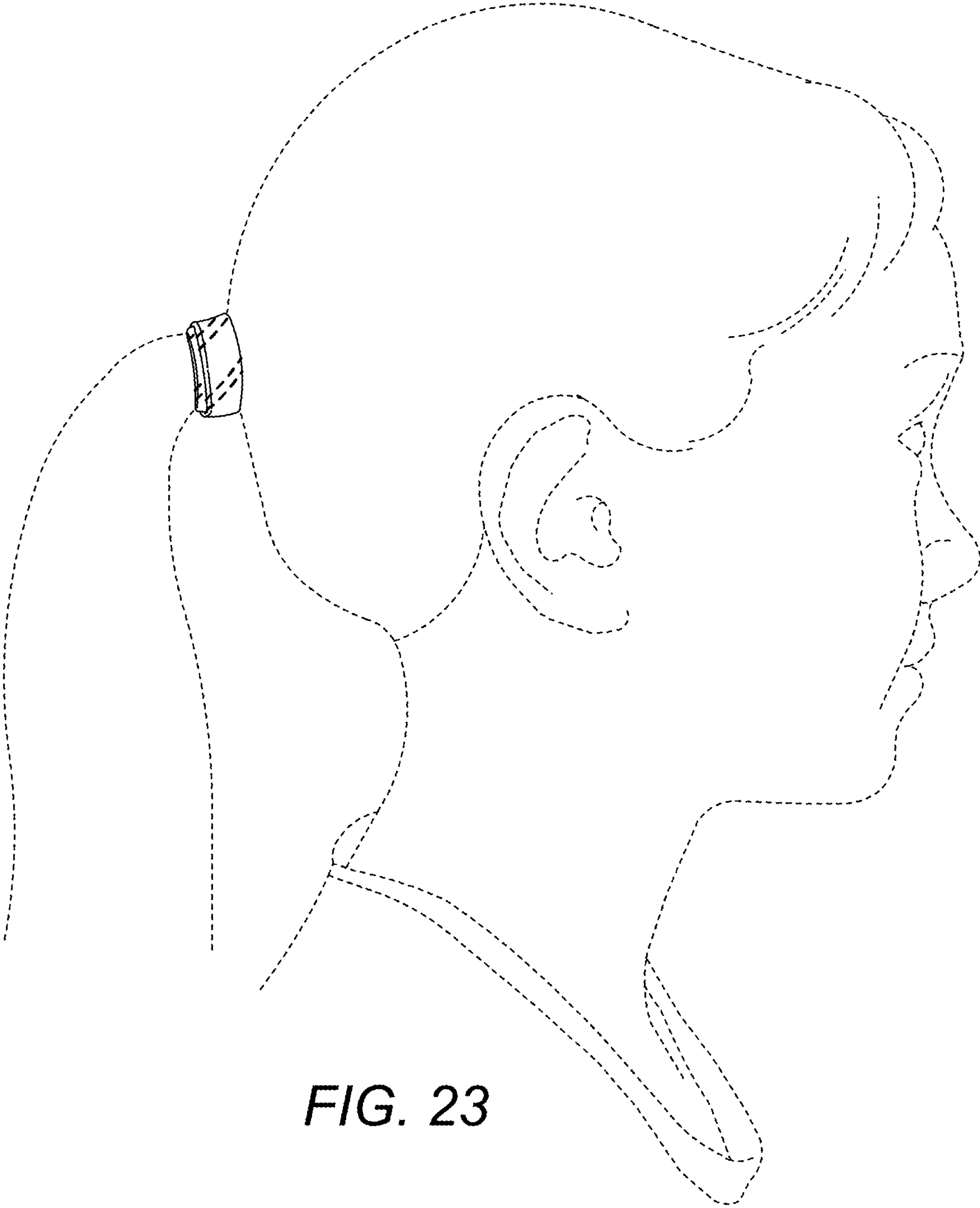

FIG. 23