



US00D913800S

(12) **United States Design Patent** (10) **Patent No.:** **US D913,800 S**
Zohar (45) **Date of Patent:** **** Mar. 23, 2021**

(54) **CACAO FRUIT BOTTLE**

(56) **References Cited**

(71) Applicant: **Blue Stripes, LLC**, New York, NY
(US)

U.S. PATENT DOCUMENTS

(72) Inventor: **Iris Zohar**, Binyamina (IL)

D604,117 S *	11/2009	Braidotti	D7/628
D611,775 S *	3/2010	Yung	D7/628
D672,207 S *	12/2012	Ehrenhaus	D7/628
D703,546 S *	4/2014	De Baschmakoff	D9/691
D763,699 S *	8/2016	Rasgon	D9/645
D783,362 S *	4/2017	Pellham	D7/518
D790,051 S *	6/2017	Valentino	D9/557

(73) Assignee: **Blue Stripes, LLC**, New York, NY
(US)

(**) Term: **15 Years**

* cited by examiner

(21) Appl. No.: **29/714,985**

Primary Examiner — Sandra L Morris

(22) Filed: **Nov. 27, 2019**

(74) *Attorney, Agent, or Firm* — Pearl Cohen Zedek
Latzer Baratz LLP

(51) **LOC (13) Cl.** **09-01**

(57) **CLAIM**

(52) **U.S. Cl.**
USPC **D9/643**; D9/645

The ornamental design for a cacao fruit bottle, as shown and described.

(58) **Field of Classification Search**

DESCRIPTION

USPC D9/600, 643–647, 500–505, 516,
D9/519–521, 549–551, 556–558;
206/457, 494, 459.5, 527, 540;
229/116.1; 215/381–384, 400;
D7/514–521, 539, 544, 571, 594, 599,
D7/604, 606, 613, 619.2, 623, 625,
D7/628–630, 391–392.1, 396.4;
D3/270–271.8
CPC B65D 67/00; B65D 81/36; B65D 81/60;
B65D 81/368; B65D 37/00; B65D 5/42;
B65D 5/4208; B65D 77/00; A63H 33/10;
A63H 33/16

FIG. 1 is a perspective view thereof;
FIG. 2 is a front elevation view thereof;
FIG. 3 is a rear elevation view thereof;
FIG. 4 is a first side elevation view;
FIG. 5 is a second side elevation view, opposite the first side;
FIG. 6 is a top view thereof; and,
FIG. 7 is a bottom view thereof.
The portions of the Figures drawn with dotted lines are
disclaimed and form no part of the claimed design.

See application file for complete search history.

1 Claim, 4 Drawing Sheets

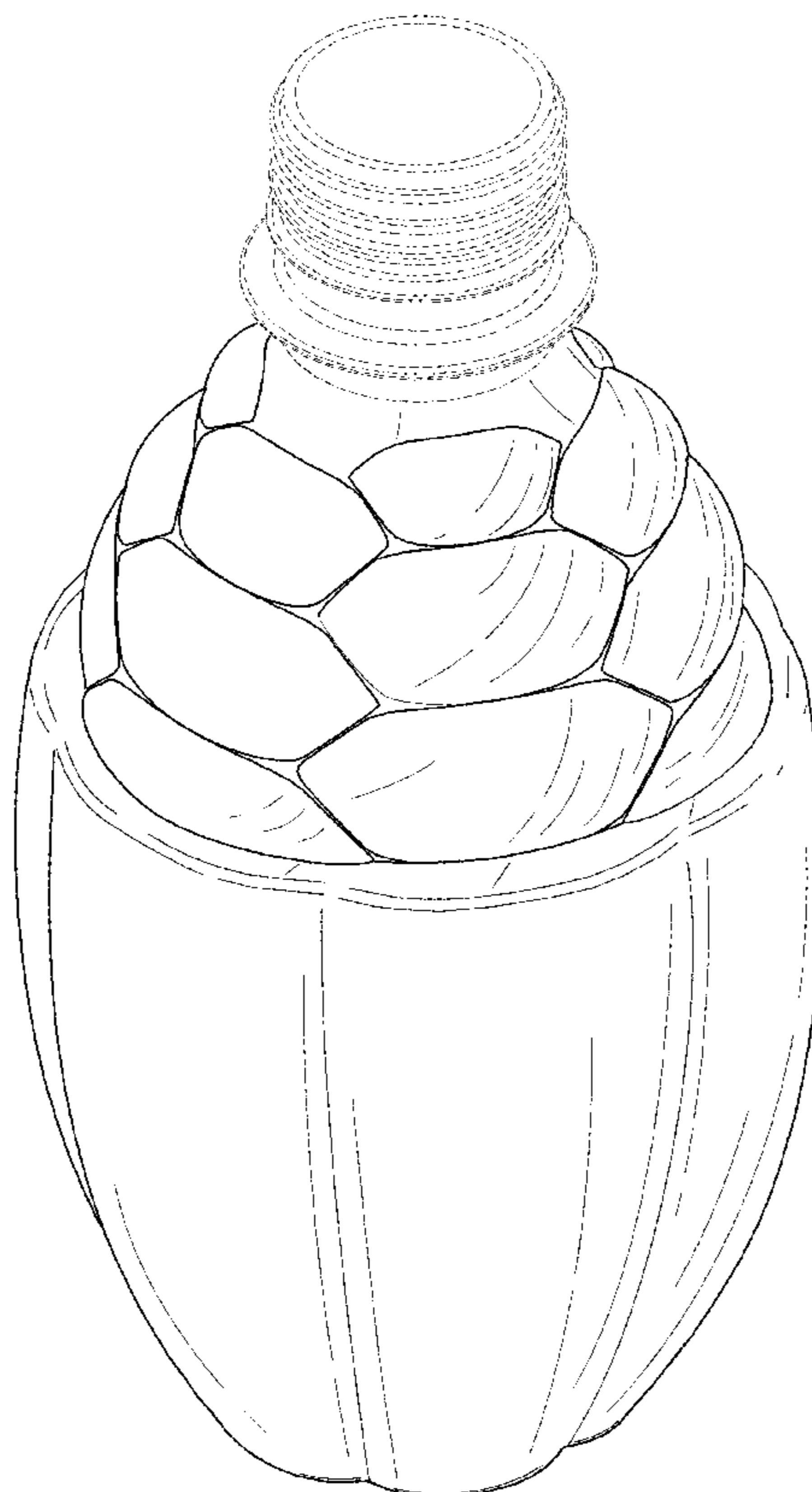



FIG. 1

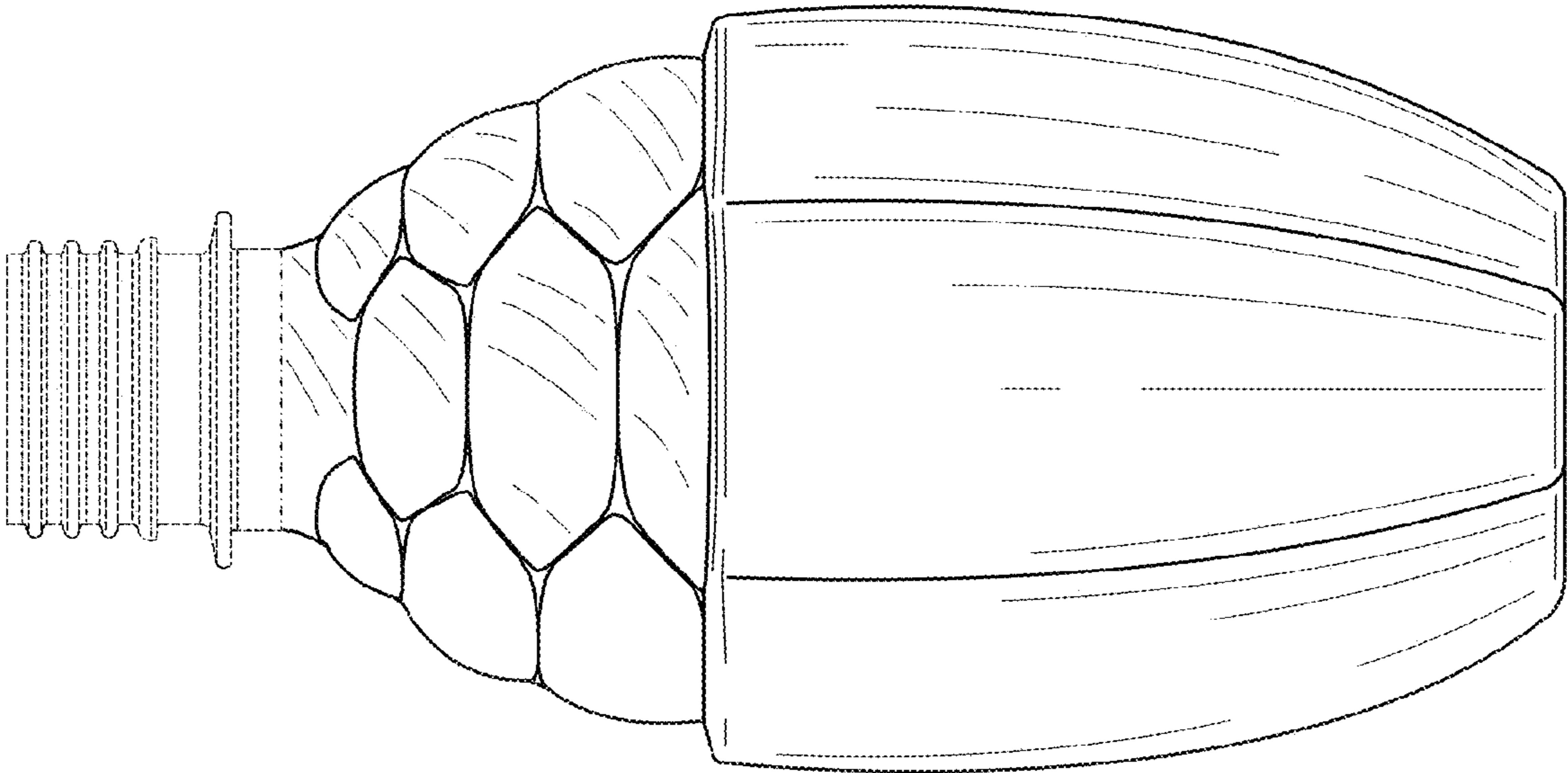

FIG. 3

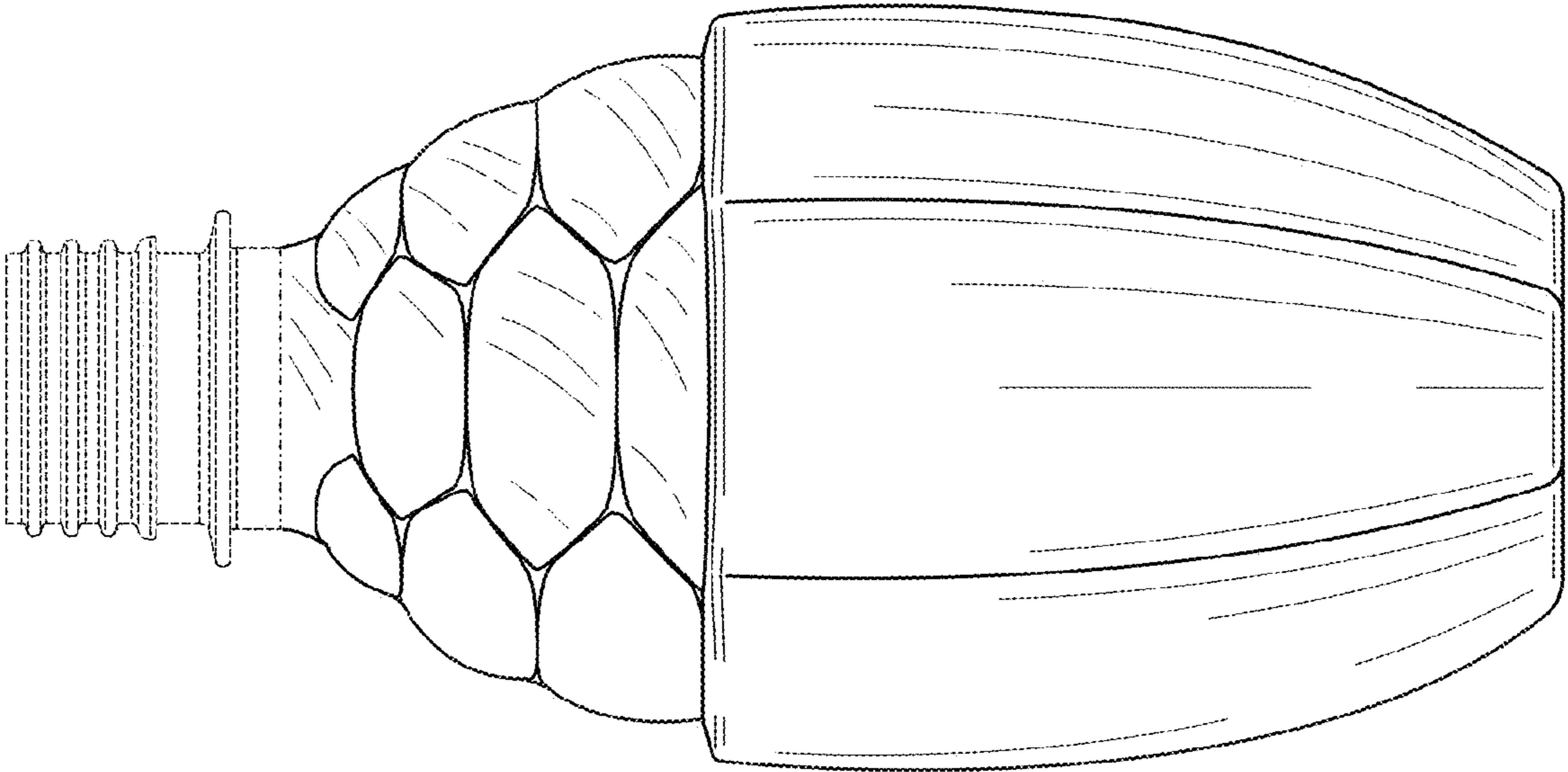

FIG. 2

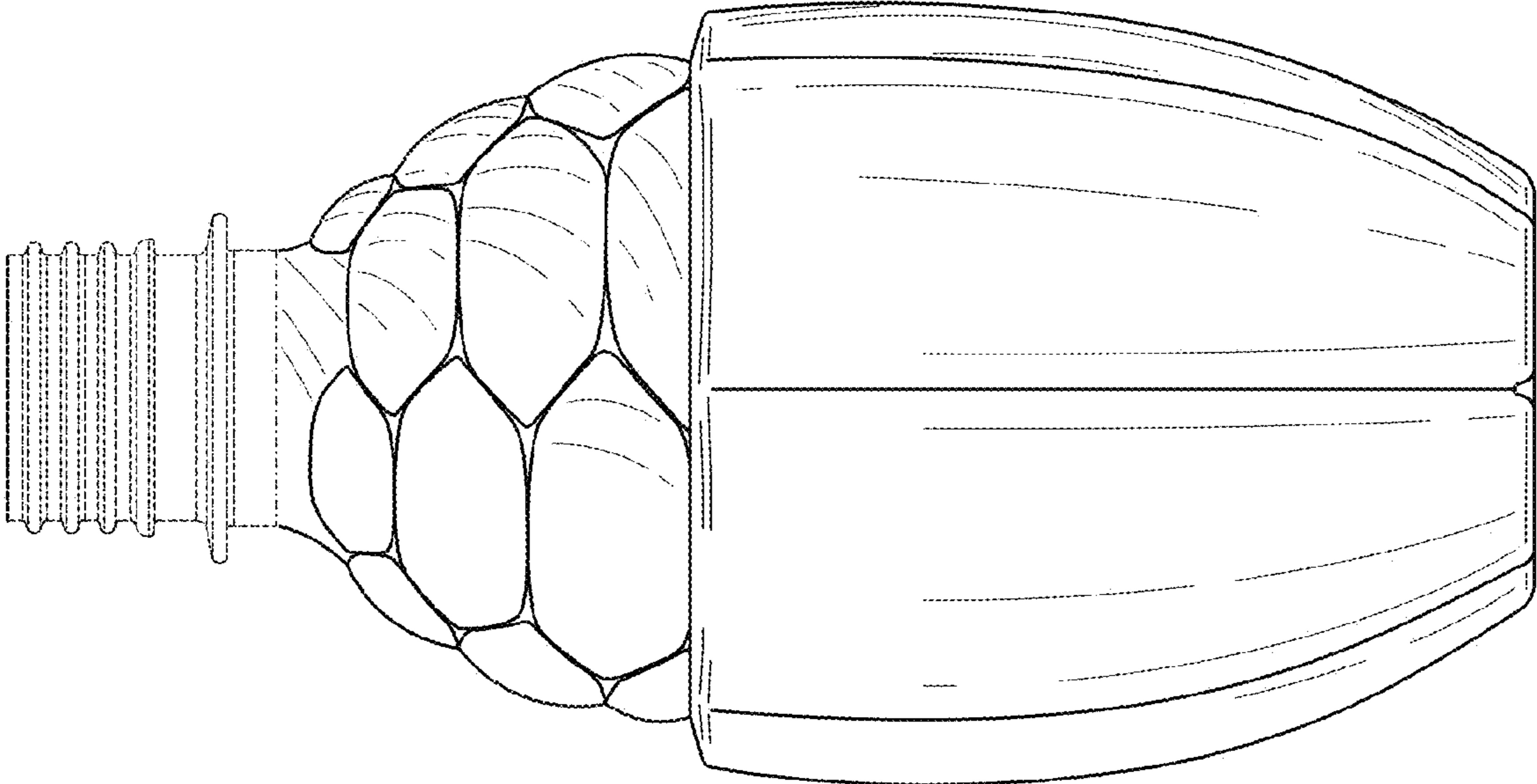

FIG. 5

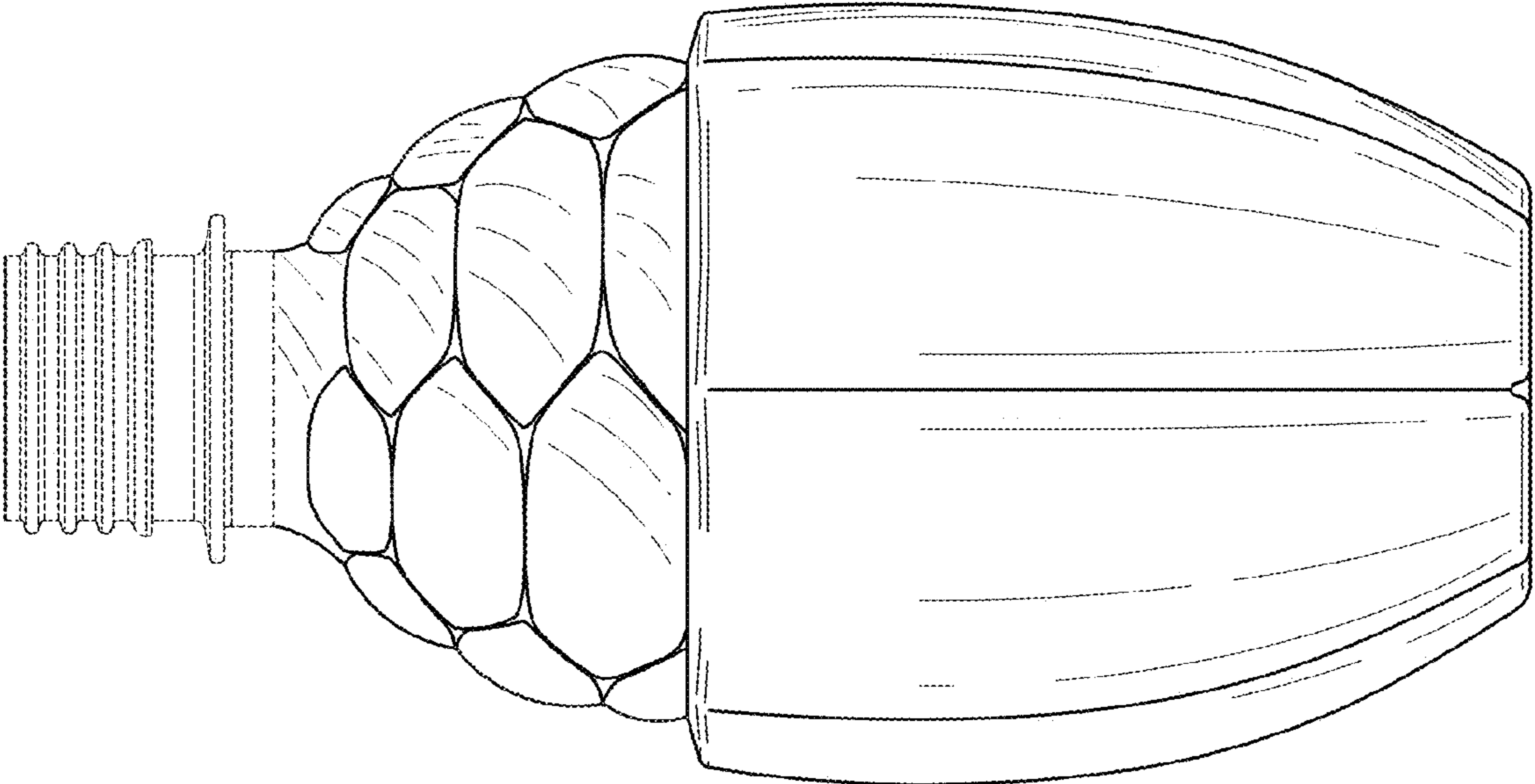

FIG. 4

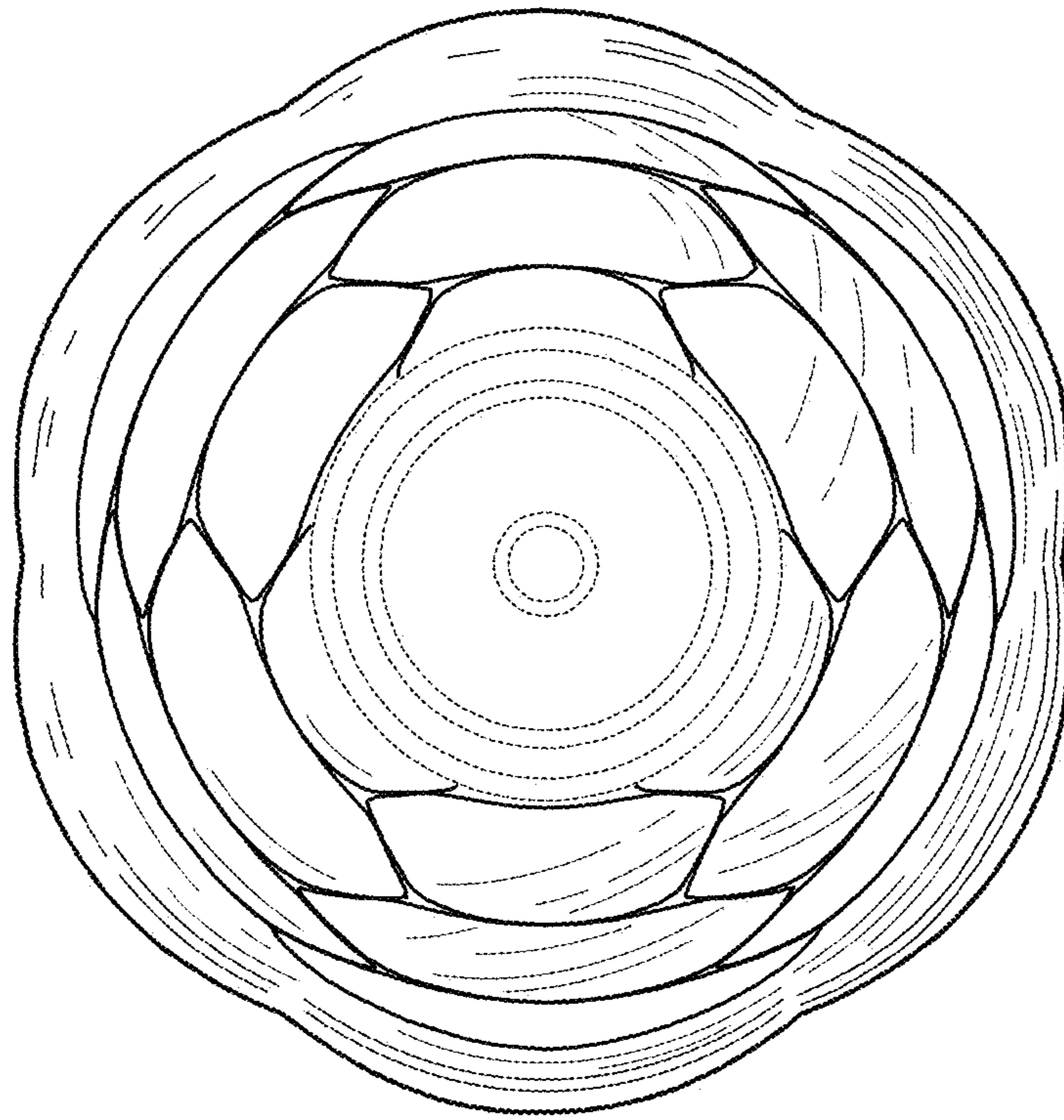

FIG. 6

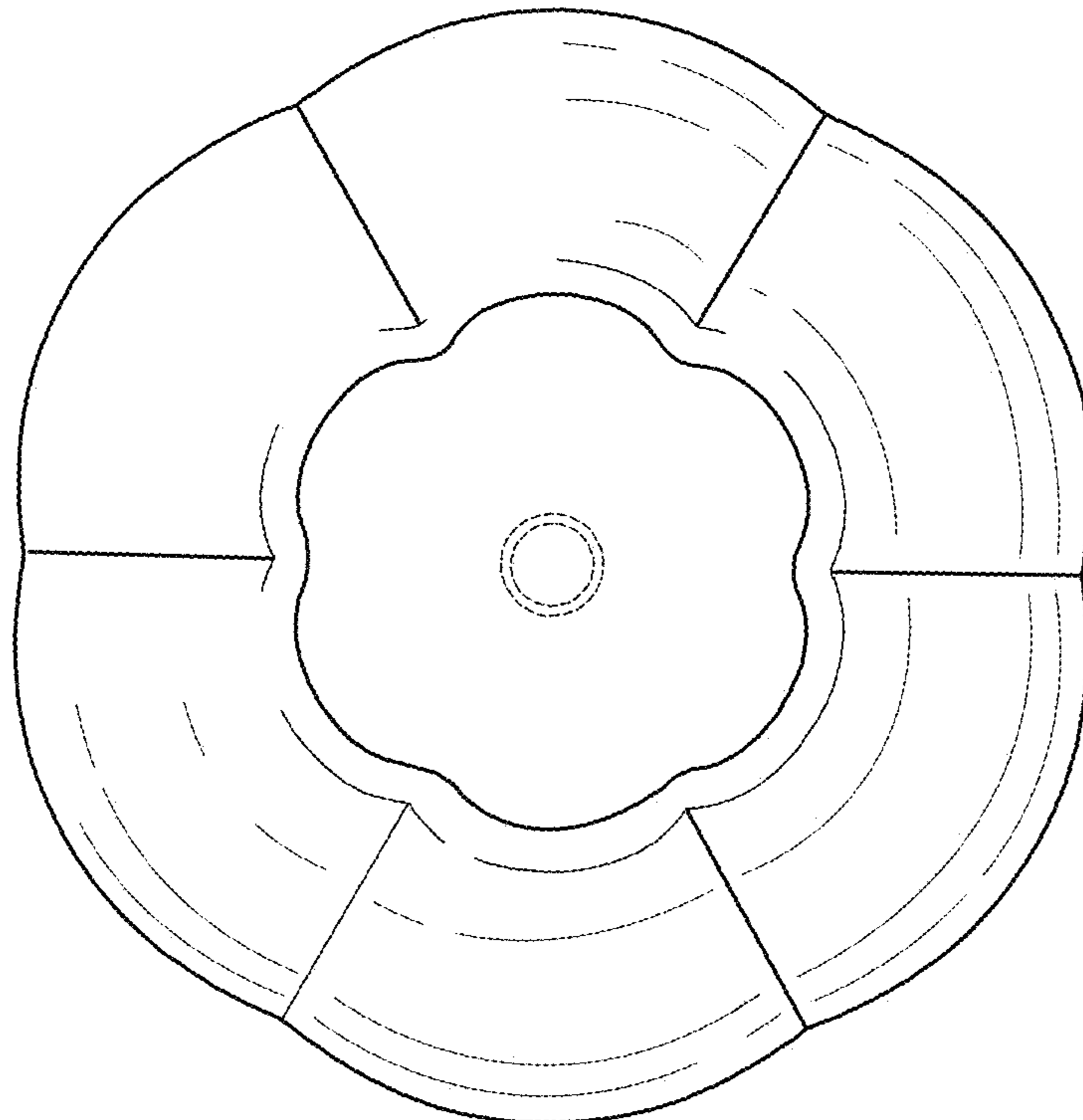

FIG. 7