



US00D913582S

(12) **United States Design Patent** (10) **Patent No.:** **US D913,582 S**  
**Tung et al.** (45) **Date of Patent:** **\*\* Mar. 16, 2021**

(54) **PACK HOLDER WITH COMPARTMENT FOR STORING USED TOBACCO CONSUMABLES**

D815,343 S \* 4/2018 Kesselman ..... D27/187  
10,131,490 B2 \* 11/2018 D'Alfonso ..... B65D 85/1045  
2005/0103654 A1 \* 5/2005 Hennessy ..... B65D 85/1054  
206/270

(Continued)

(71) Applicant: **Philip Morris Products S.A.**,  
Neuchatel (CH)

FOREIGN PATENT DOCUMENTS

(72) Inventors: **Jeffrey Tung**, San Francisco, CA (US);  
**Jenny Yoon Joo Lee**, San Francisco,  
CA (US)

CN 201430202452.9 12/2014  
CN 201530007798.8 8/2015

(Continued)

(73) Assignee: **Philip Morris Products S.A.**,  
Neuchatel (CH)

OTHER PUBLICATIONS

(\*\*) Term: **15 Years**

Office Action dated Dec. 11, 2019 in corresponding Russian Patent Application No. 2018505762/49 (with English Translation), citing documents AO-AR therein, 4 pages.

(21) Appl. No.: **29/675,770**

*Primary Examiner* — Marissa J Cash

(22) Filed: **Jan. 4, 2019**

*Assistant Examiner* — Rebecca Tsehaye

(30) **Foreign Application Priority Data**

(74) *Attorney, Agent, or Firm* — Oblon, McClelland,  
Maier & Neustadt, L.L.P.

Jul. 6, 2018 (EM) ..... 005445509-0006  
Jul. 6, 2018 (EM) ..... 005445509-0008

(57) **CLAIM**

(51) **LOC (13) Cl.** ..... **27-06**

The ornamental design for a pack holder with compartment for storing used tobacco consumables, as shown and described.

(52) **U.S. Cl.**  
USPC ..... **D27/187**

**DESCRIPTION**

(58) **Field of Classification Search**  
USPC ..... D27/187, 102, 103, 106, 125, 133, 135,  
D27/172, 183, 186, 188, 192-194;  
131/329, 231, 235.1, 238, 242, 256;  
206/246, 242, 259, 256  
CPC ..... A01G 9/00; A01G 9/02; A01G 9/021  
See application file for complete search history.

FIG. 1 is a front, top, and left side perspective view of a pack holder with compartment for storing used tobacco consumables;  
FIG. 2 is a front elevational view thereof;  
FIG. 3 is a rear elevational view thereof;  
FIG. 4 is a top plan view thereof;  
FIG. 5 is a bottom plan view thereof;  
FIG. 6 is a right side elevational view thereof; and,  
FIG. 7 is a left side elevational view thereof.

(56) **References Cited**

U.S. PATENT DOCUMENTS

D74,700 S \* 3/1928 Sklar ..... D27/172  
D296,718 S \* 7/1988 Takanashi ..... D27/183  
4,850,481 A \* 7/1989 Chern ..... A24F 15/18  
206/249

The broken lines in the drawings depict portions of the pack holder with compartment for storing used tobacco consumables that form no part of the claimed design.

**1 Claim, 7 Drawing Sheets**

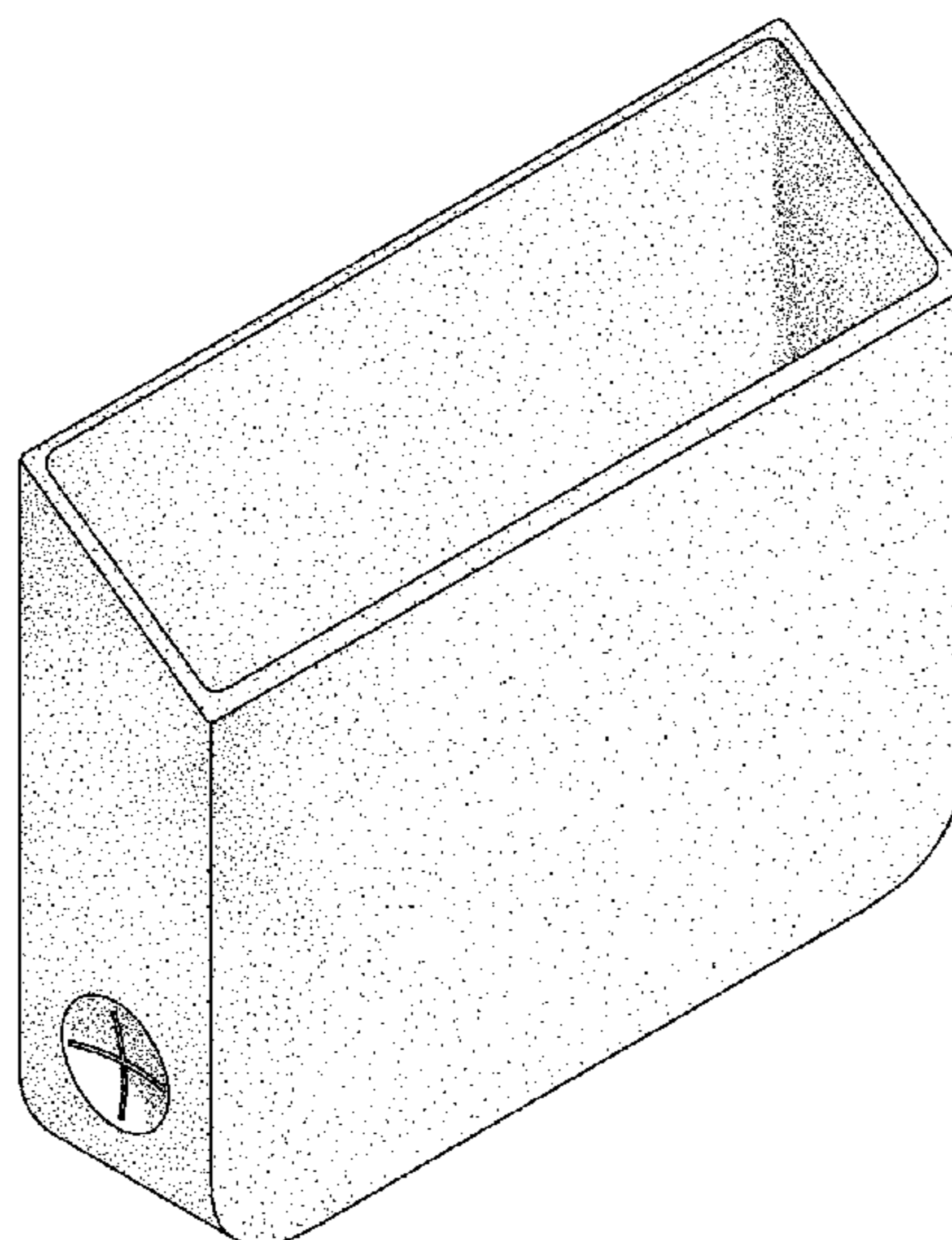

(56)

**References Cited**

U.S. PATENT DOCUMENTS

2009/0242434 A1\* 10/2009 Ghini ..... B65D 85/1081  
206/246  
2015/0034507 A1\* 2/2015 Liu ..... B65D 85/10  
206/256  
2016/0090230 A1\* 3/2016 Dong ..... B65D 33/18  
206/246  
2018/0022538 A1\* 1/2018 Li Vigni ..... B65B 11/004  
206/259  
2020/0037661 A1\* 2/2020 Slate ..... A24F 25/02

FOREIGN PATENT DOCUMENTS

CN 201530052423.3 9/2015  
CN 201730169884.8 10/2017

\* cited by examiner

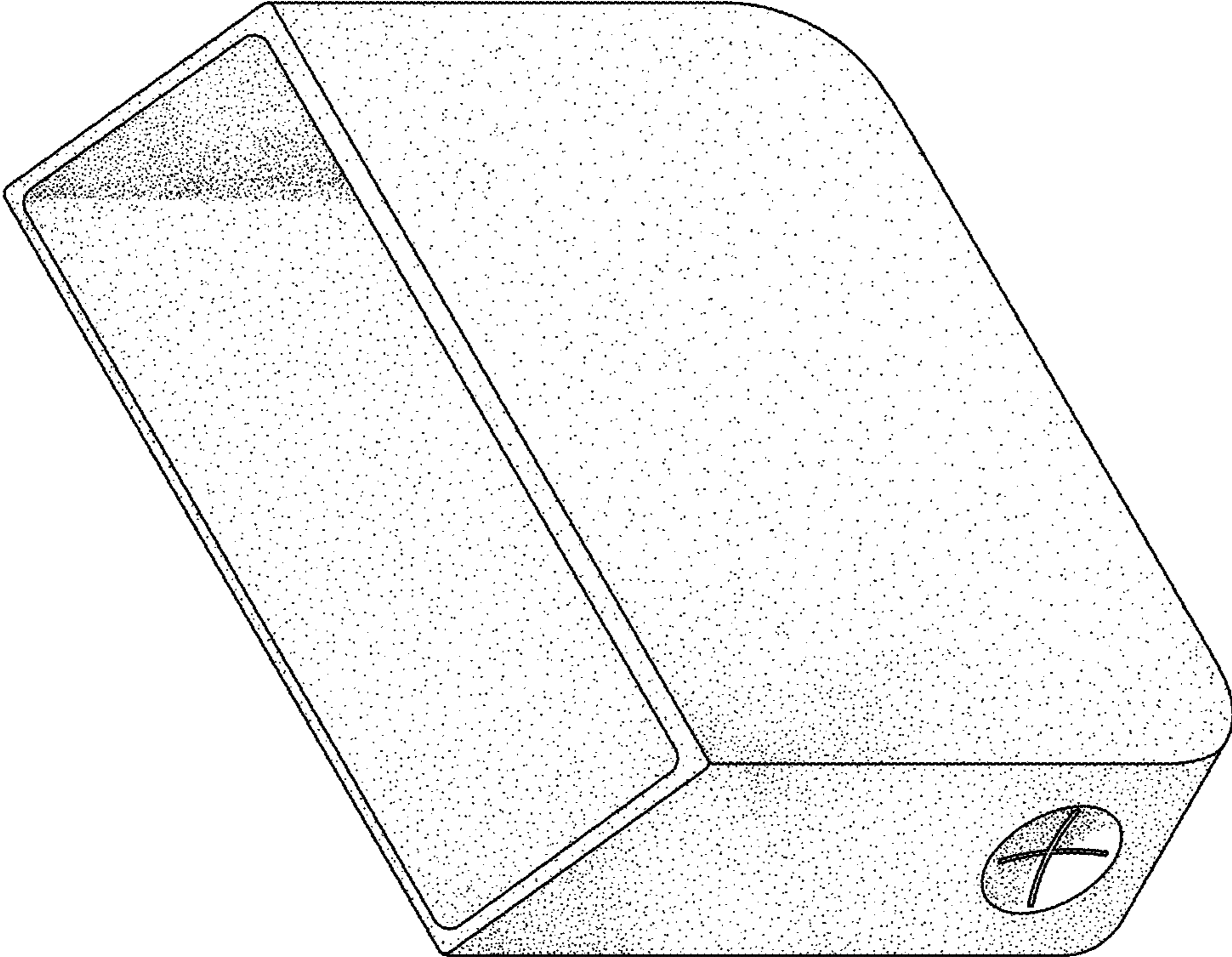

FIG. 1

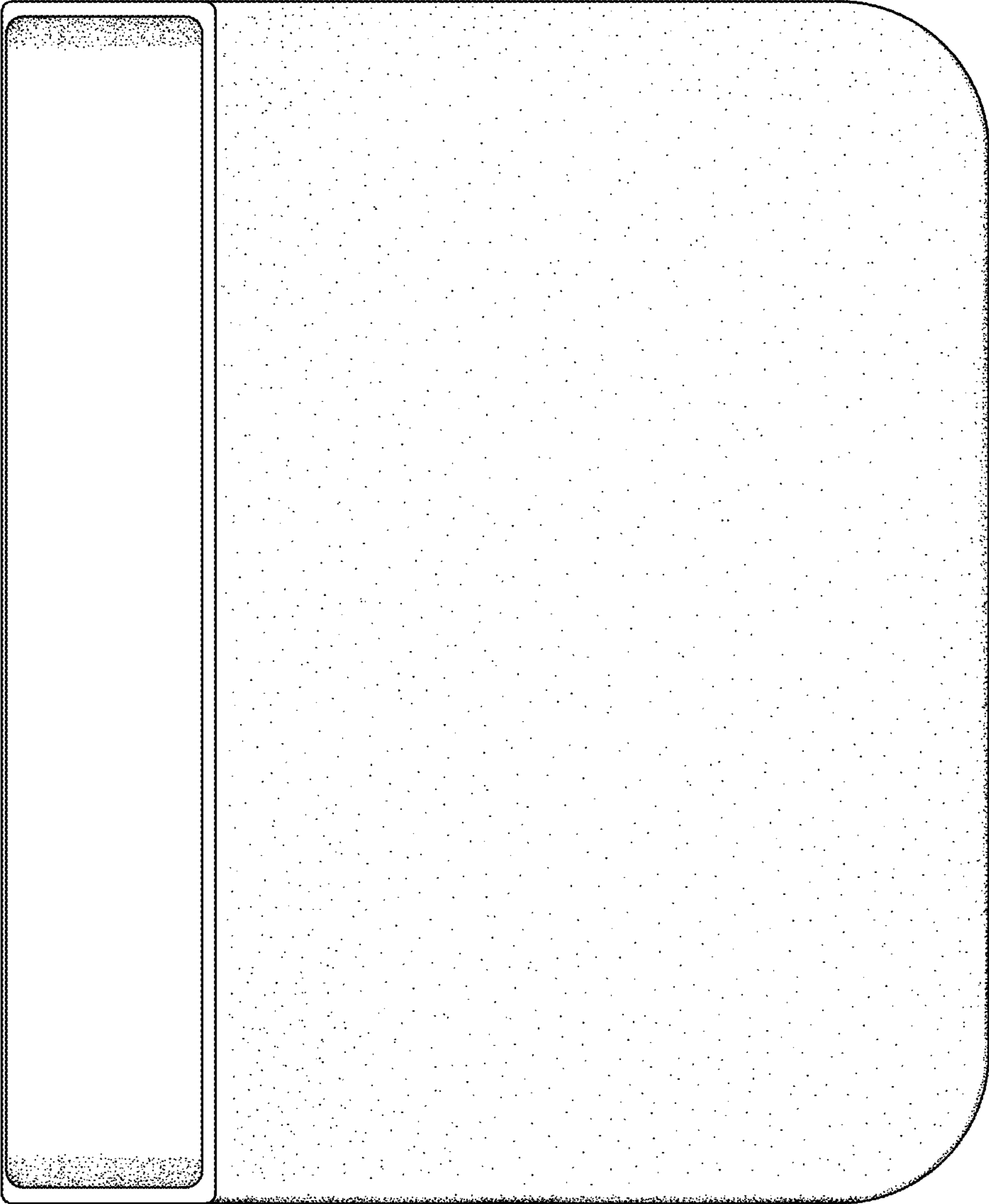

FIG. 2

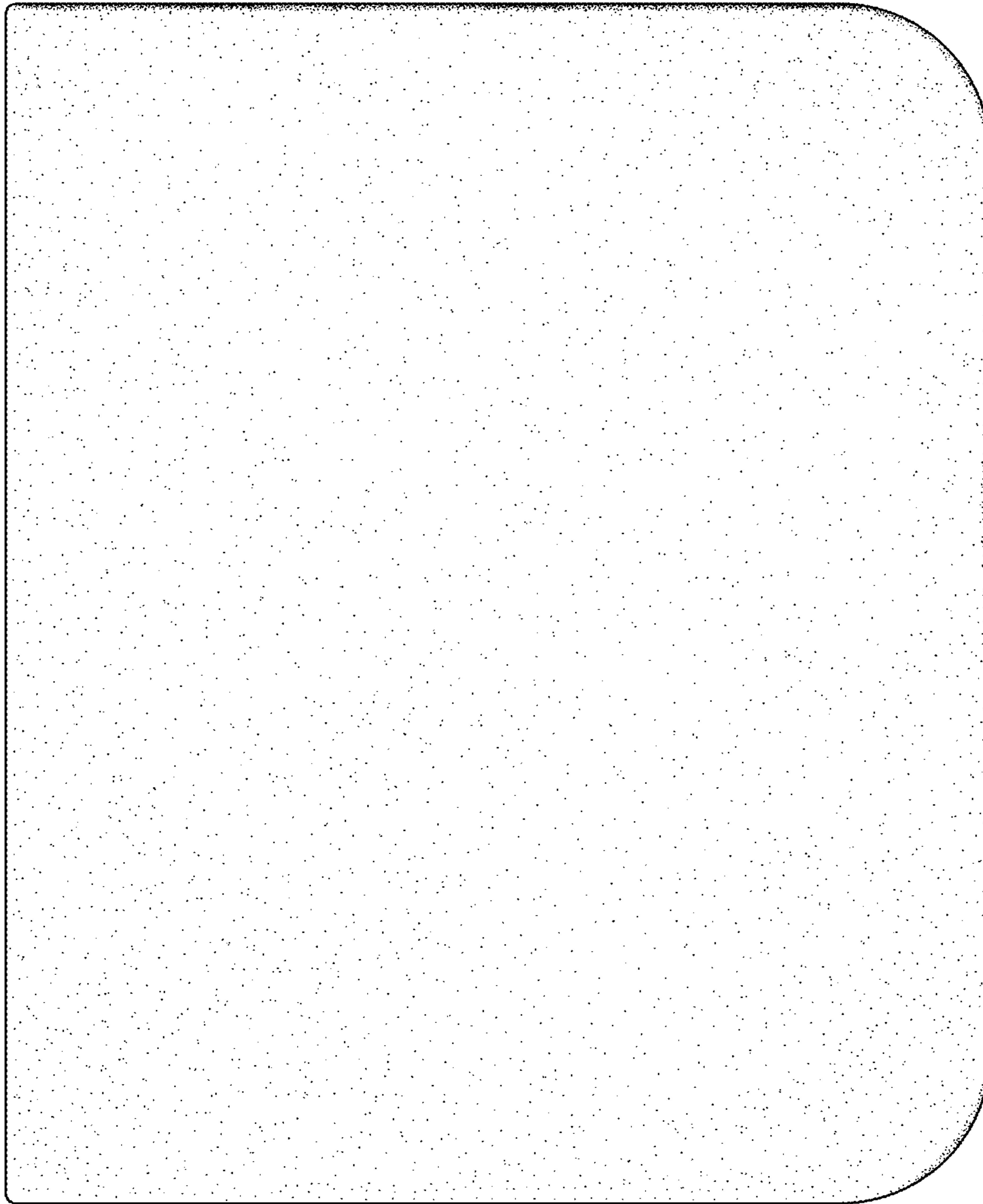

FIG. 3

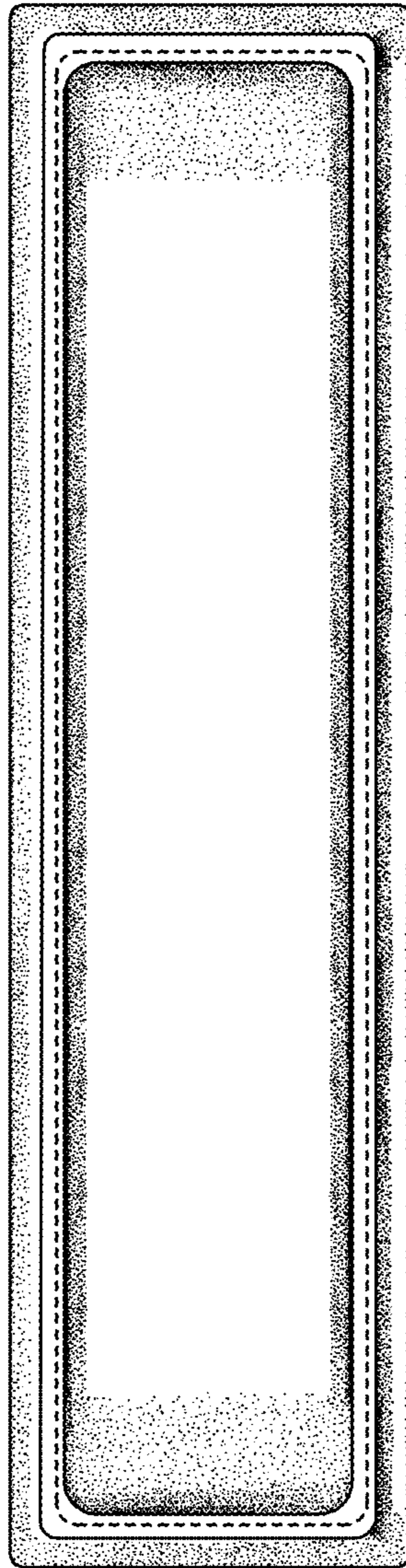

FIG. 4

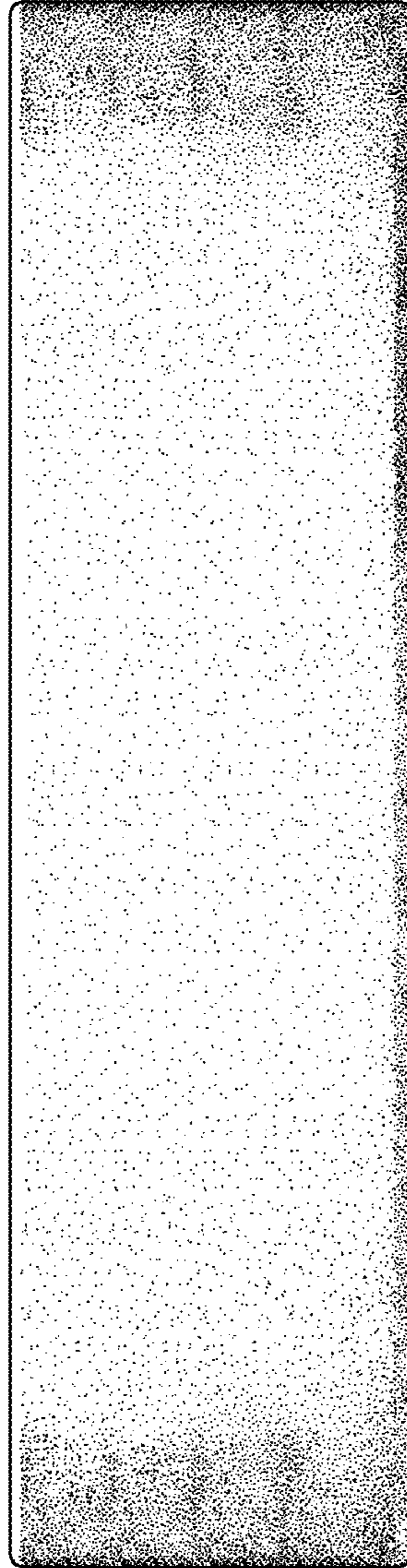

FIG. 5

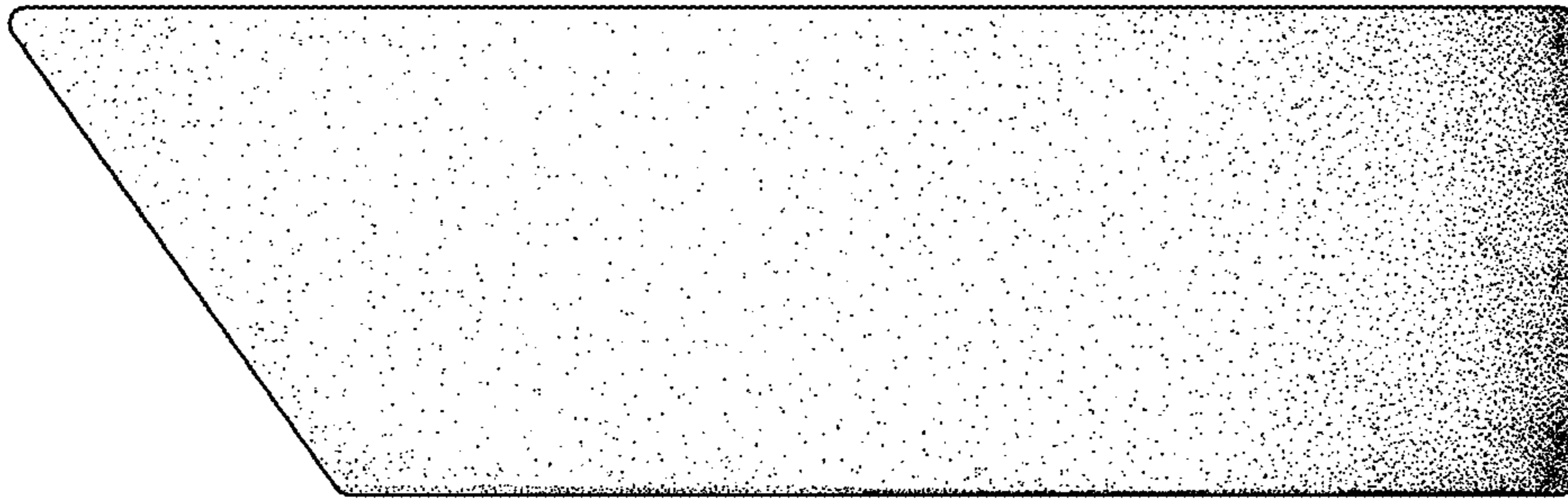

FIG. 6



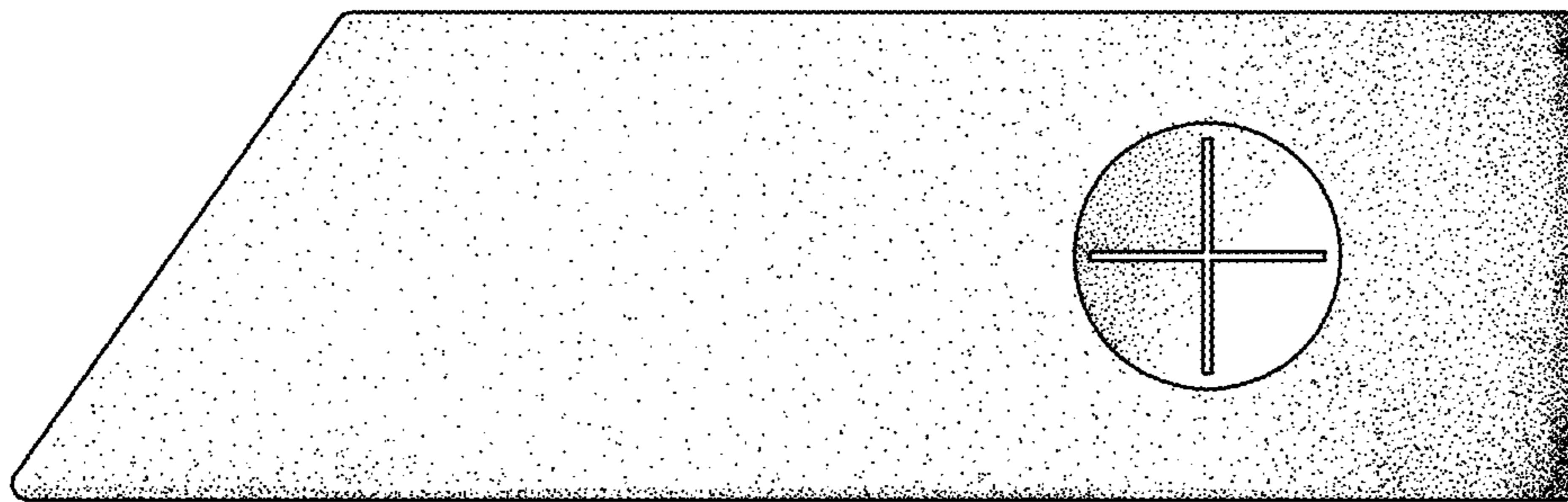

FIG. 7