



US00D913492S

(12) **United States Design Patent** (10) **Patent No.:** **US D913,492 S**
Webb (45) **Date of Patent:** **** Mar. 16, 2021**

(54) **URINAL RECEPTACLE**

(71) Applicant: **Hygienius Intellectual Property B.V.**,
Breukelen (NL)

(72) Inventor: **Ian Webb**, London (GB)

(73) Assignee: **HYGIENIUS INTELLECTUAL
PROPERTY B.V.**, Breukelen (NL)

(**) Term: **15 Years**

(21) Appl. No.: **35/507,521**

(22) Filed: **Mar. 6, 2019**

(80) **Hague Agreement Data**

Int. Filing Date: **Mar. 6, 2019**

Int. Reg. No.: **DM/203397**

Int. Reg. Date: **Mar. 6, 2019**

Int. Reg. Pub. Date: **Oct. 18, 2019**

(51) **LOC (13) Cl.** **24-04**

(52) **U.S. Cl.**
USPC **D24/122**; D24/118

(58) **Field of Classification Search**
USPC D24/117, 118, 121, 122, 123, 207, 216,
D24/224; D23/200, 274, 276, 295, 302,
D23/309, 365, 209; 4/450-460,
4/144.1-144.4; D9/600, 643, 702-714,
D9/414, 415, 418, 420-422, 430, 431,
D9/432, 433; D3/270, 271.1-271.4
CPC A61G 9/00; A61G 9/006; A61G 9/003;
A61G 2205/30; A61F 5/4556; A61F
5/3746; A61F 5/455; A61F 2005/4402;
A61F 5/451; A61F 5/453; A47K 11/12;
A47K 11/06; A61M 1/00; A61B 10/007;
A61J 19/00; A61J 1/05; A61J 1/18; B65D
5/40; B65D 75/008

See application file for complete search history.

(56) **References Cited**

U.S. PATENT DOCUMENTS

D407,970	S	*	4/1999	Planchard	D9/703
D449,979	S	*	11/2001	Planchard	D9/430
D532,690	S	*	11/2006	Oliveira	D9/431
7,546,924	B2	*	6/2009	Oliveira	B65D 5/2009 206/784
D775,780	S	*	1/2017	Horowitz	D2/700
D814,916	S	*	4/2018	Hoekstra	D9/414
D839,102	S	*	1/2019	Boyd	D9/709
D847,625	S	*	5/2019	Bryzek	D9/418
D848,858	S	*	5/2019	Tastan	D9/705
D850,907	S	*	6/2019	Moberg	D9/430

(Continued)

OTHER PUBLICATIONS

https://www.walmart.com/ip/OTVIAP-Silicone-Urine-Collector-Bag-Adults-Urinal-with-Urine-Catheter-Bags-for-Older-Men-Woman-Urine-Catheter-Bags-Urine-Collector/723935387?wmlspartner=wlpa&selectedSellerId=101007465&&adid=2222222227324410597&wl0=&wl1=g&wl2=c&wl3=404796088749&wl4=pla-848137827753&wl5=90039.*

(Continued)

Primary Examiner — Samantha Q Lawrence
(74) *Attorney, Agent, or Firm* — Cantor Colburn LLP

(57) **CLAIM**

The ornamental design for a urinal receptacle, as shown and described.

DESCRIPTION

Figure 1.1 is a bottom view of a urinal receptacle shown in a closed position;
Figure 1.2 is a front perspective view thereof;
Figure 1.3 is a front view thereof;
Figure 1.4 is a rear perspective view thereof;
Figure 1.5 is a rear view thereof;

(Continued)

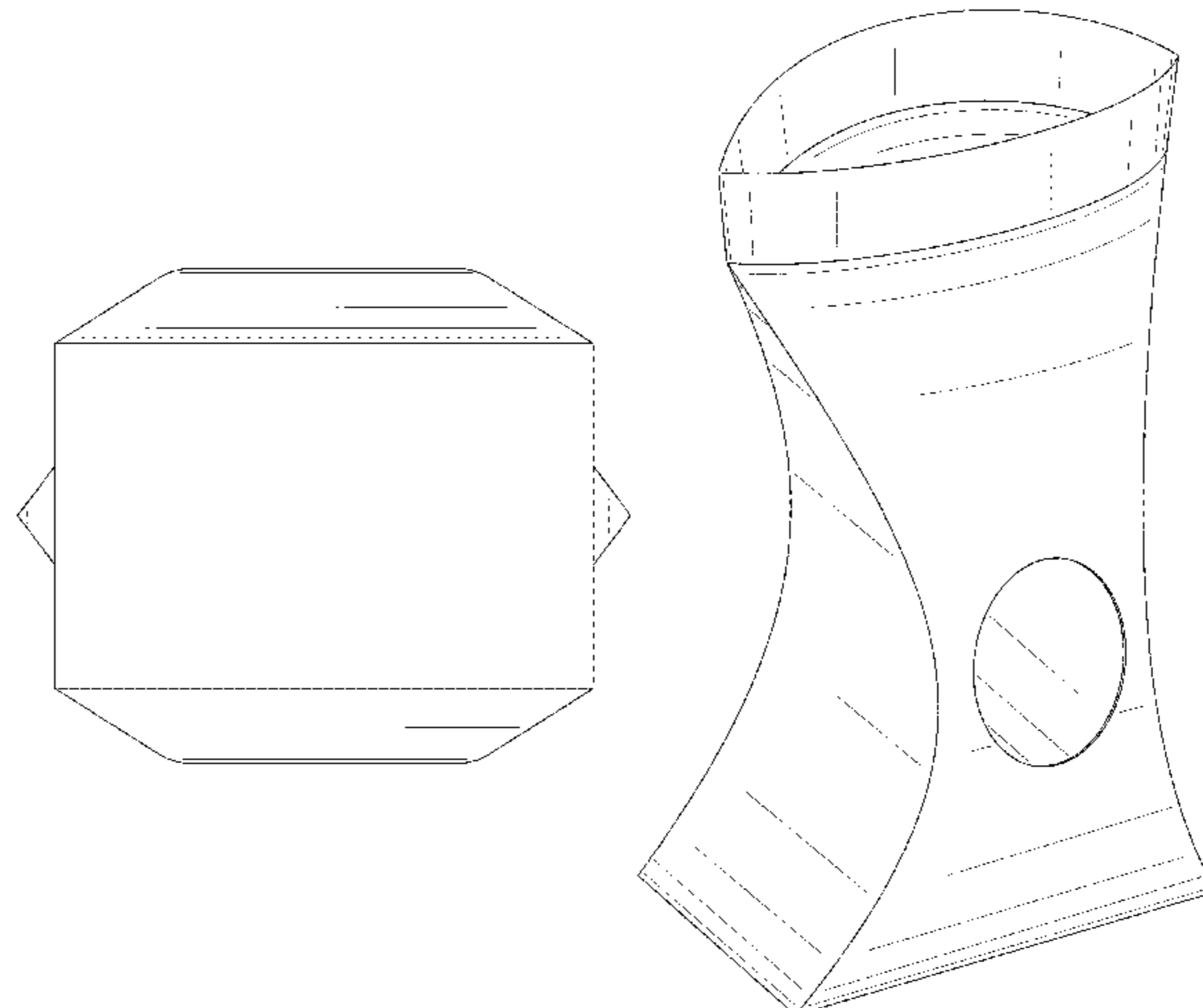

Figure 1.6 is a left side view thereof;
Figure 1.7 is a top plan view thereof;
Figure 1.8 is a bottom view of the urinal receptacle shown
in an open position;
Figure 1.9 is a front perspective view thereof;
Figure 1.10 is a front view thereof;
Figure 1.11 is a rear perspective view thereof;
Figure 1.12 is a rear view thereof;
Figure 1.13 is a left side view thereof; and
Figure 1.14 is a top plan view thereof.

1 Claim, 14 Drawing Sheets

(56) **References Cited**

U.S. PATENT DOCUMENTS

D870,556 S * 12/2019 Tart D9/431
D882,411 S * 4/2020 Jacobsson D9/712
2012/0141051 A1* 6/2012 Barry A61J 19/00
383/121
2019/0358108 A1* 11/2019 Cocks A61F 5/4556

OTHER PUBLICATIONS

100/200ml Hospital Use Kinds of Medical Grade PVC Drainage
Padiatric Urine Bag with CE and ISO [http://sanwellmedical-com.
sell.everychina.com/p-106572874-100-200ml-hospital-use-kinds-of-
nmedical-grade-pvc-drainage-padiatric-urine-bag-with-ce-and-iso.
html](http://sanwellmedical-com.sell.everychina.com/p-106572874-100-200ml-hospital-use-kinds-of-nmedical-grade-pvc-drainage-padiatric-urine-bag-with-ce-and-iso.html) Date Unknown.*

* cited by examiner

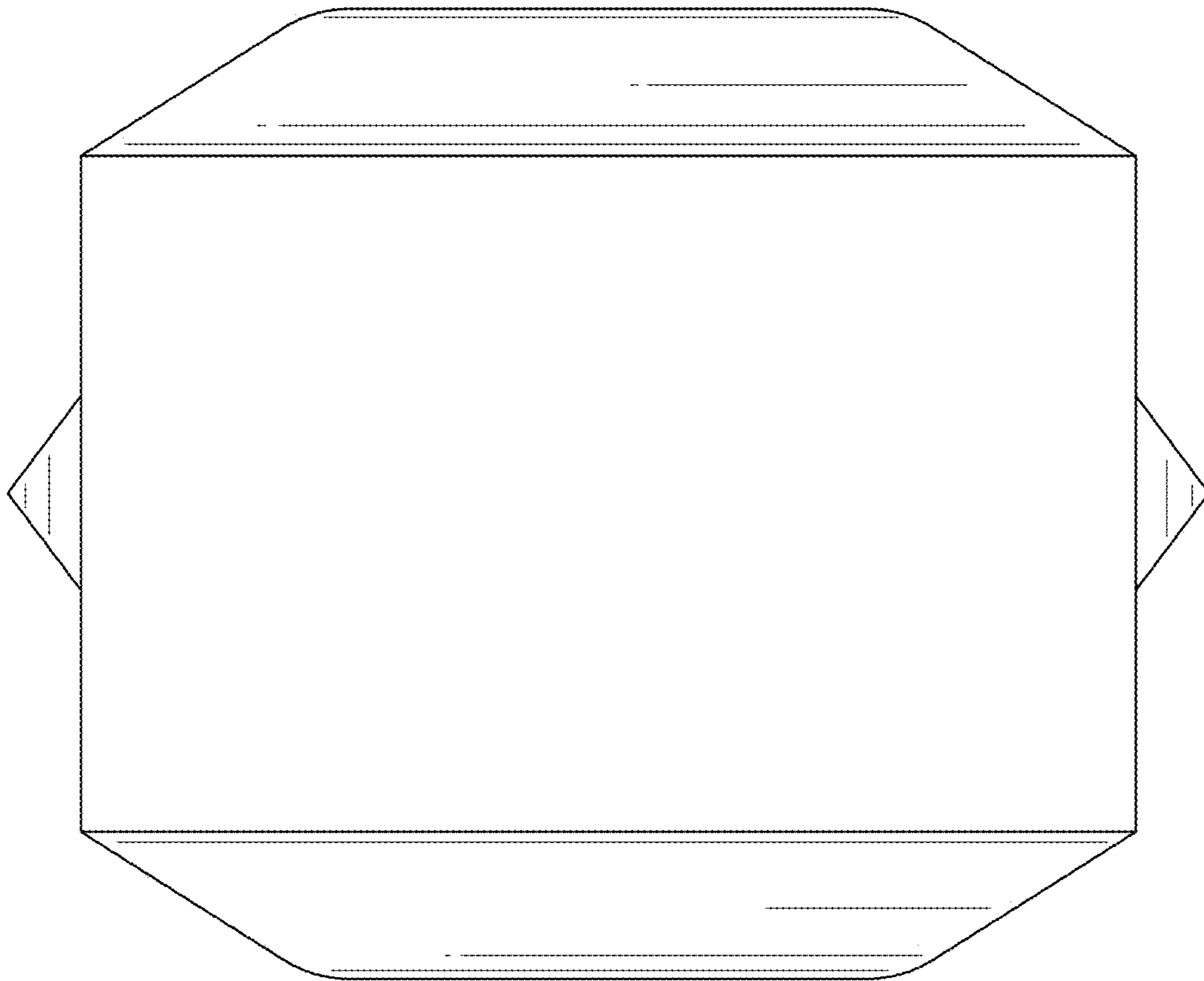

11

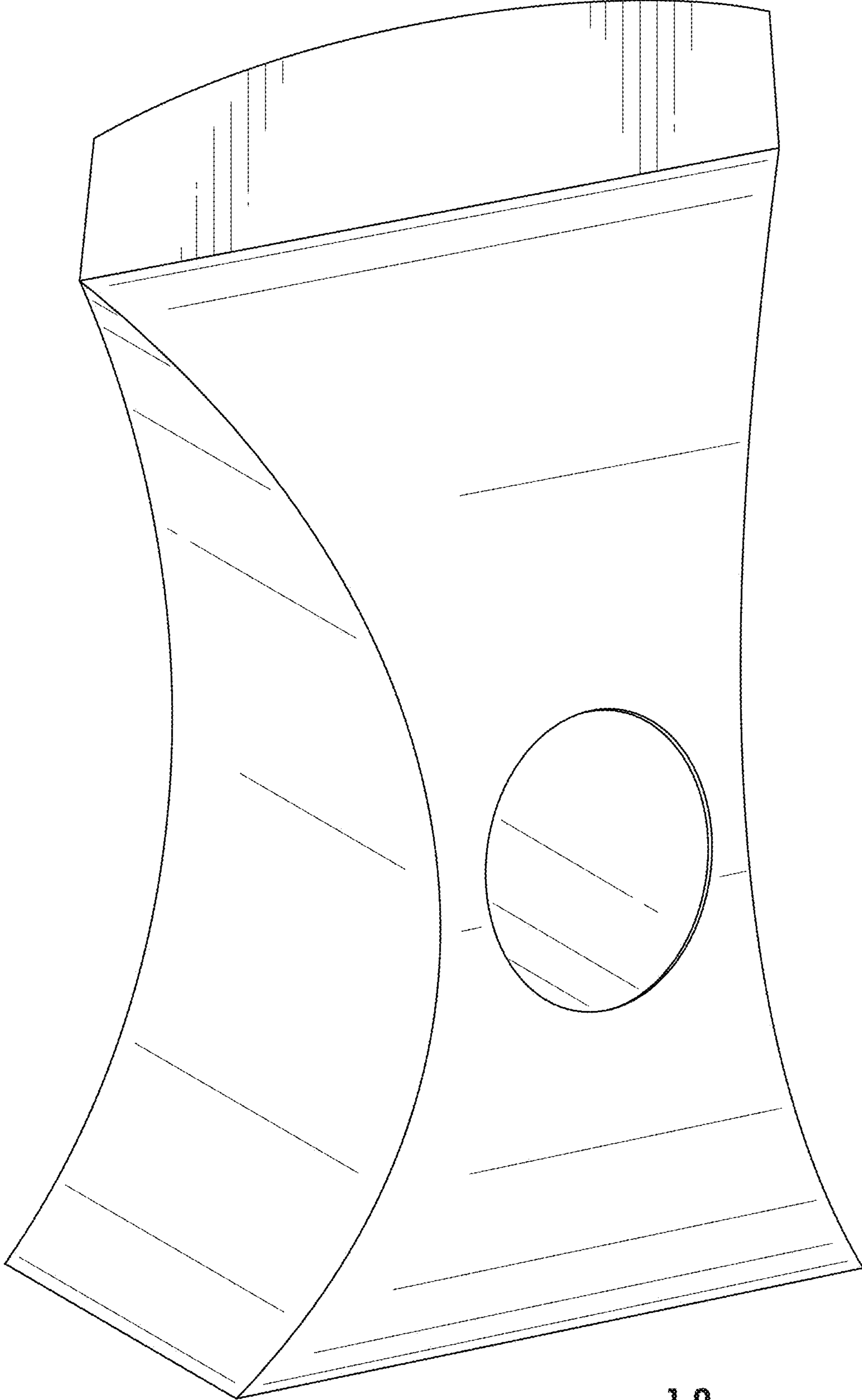

1.2

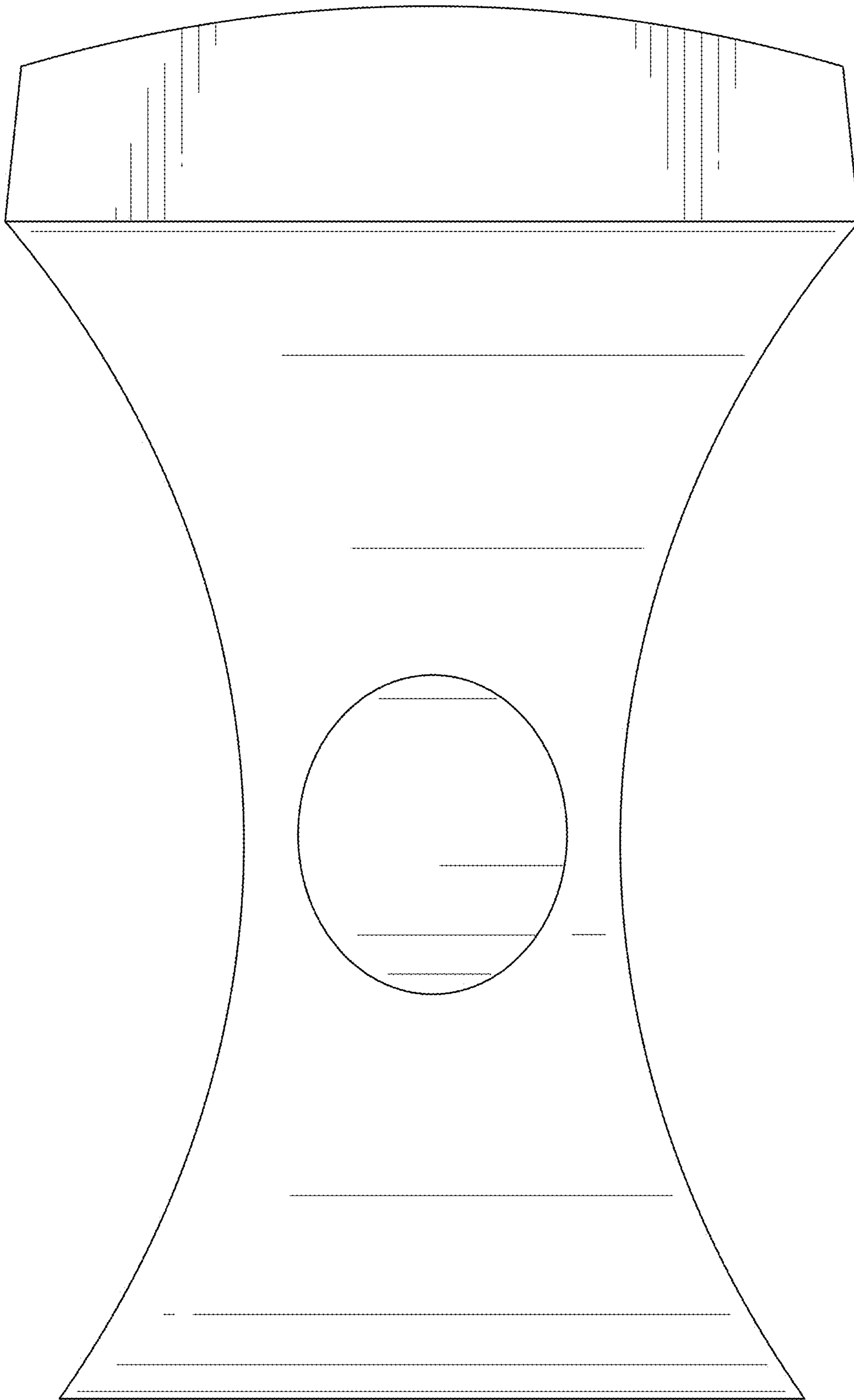

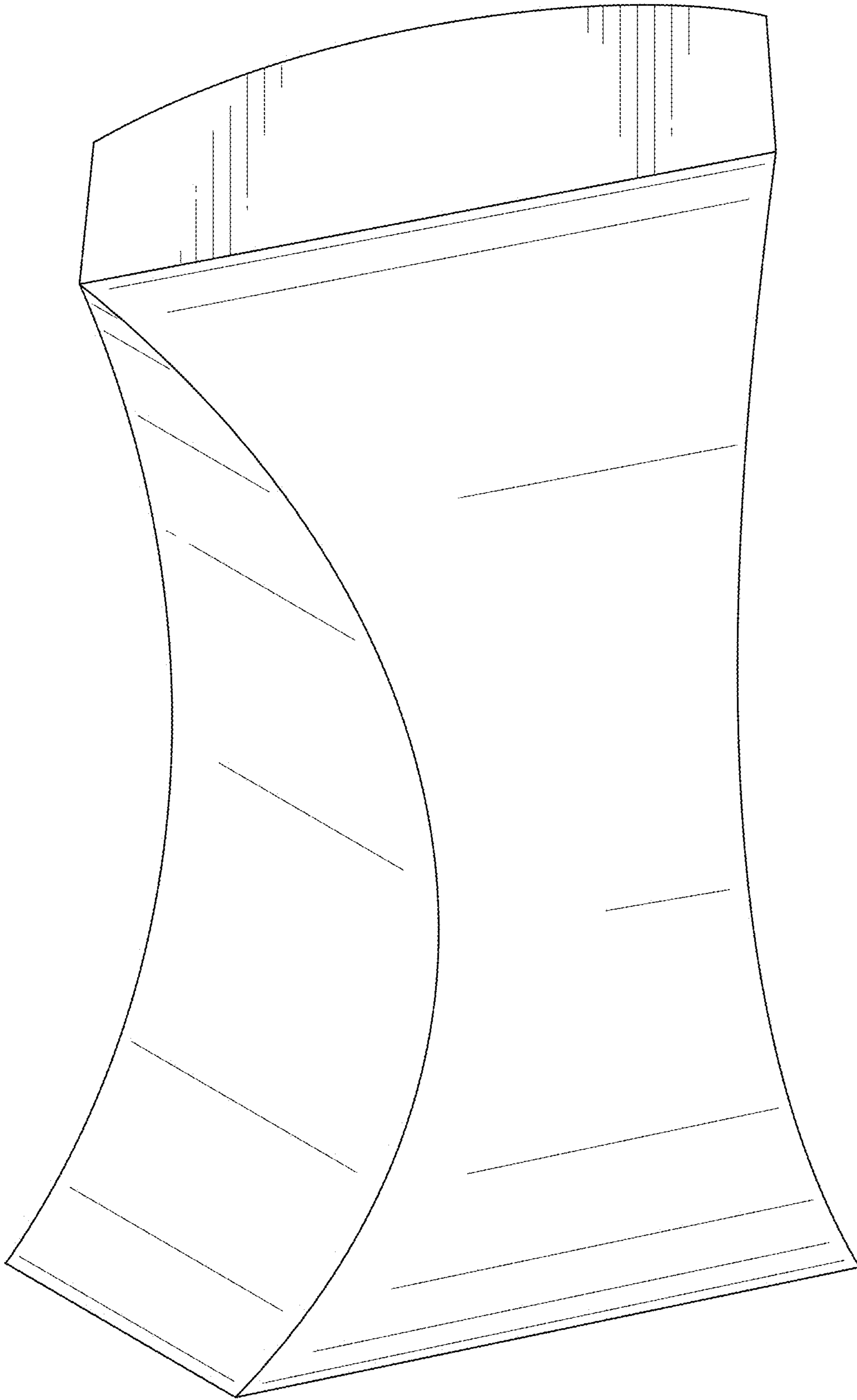

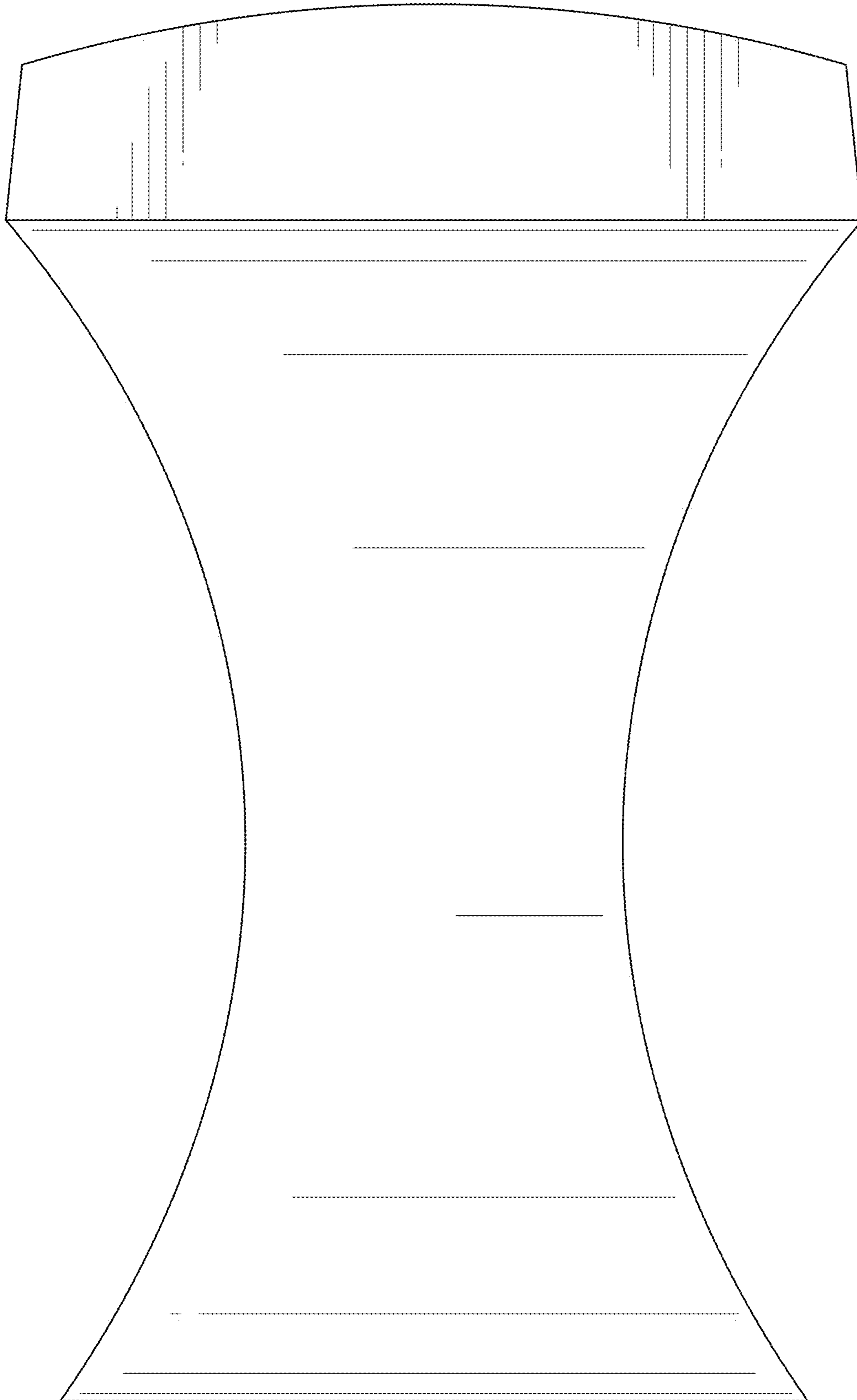

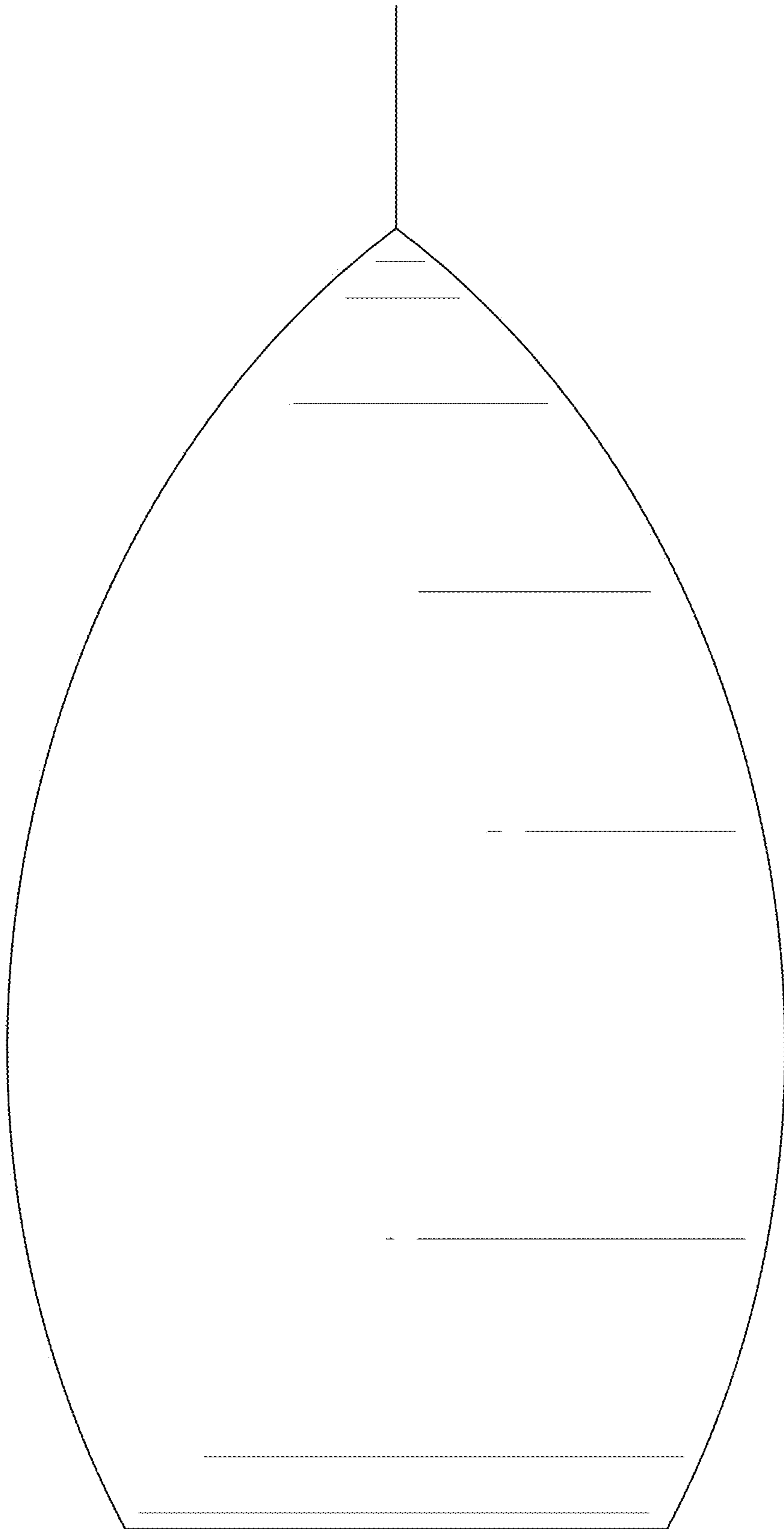

1.6

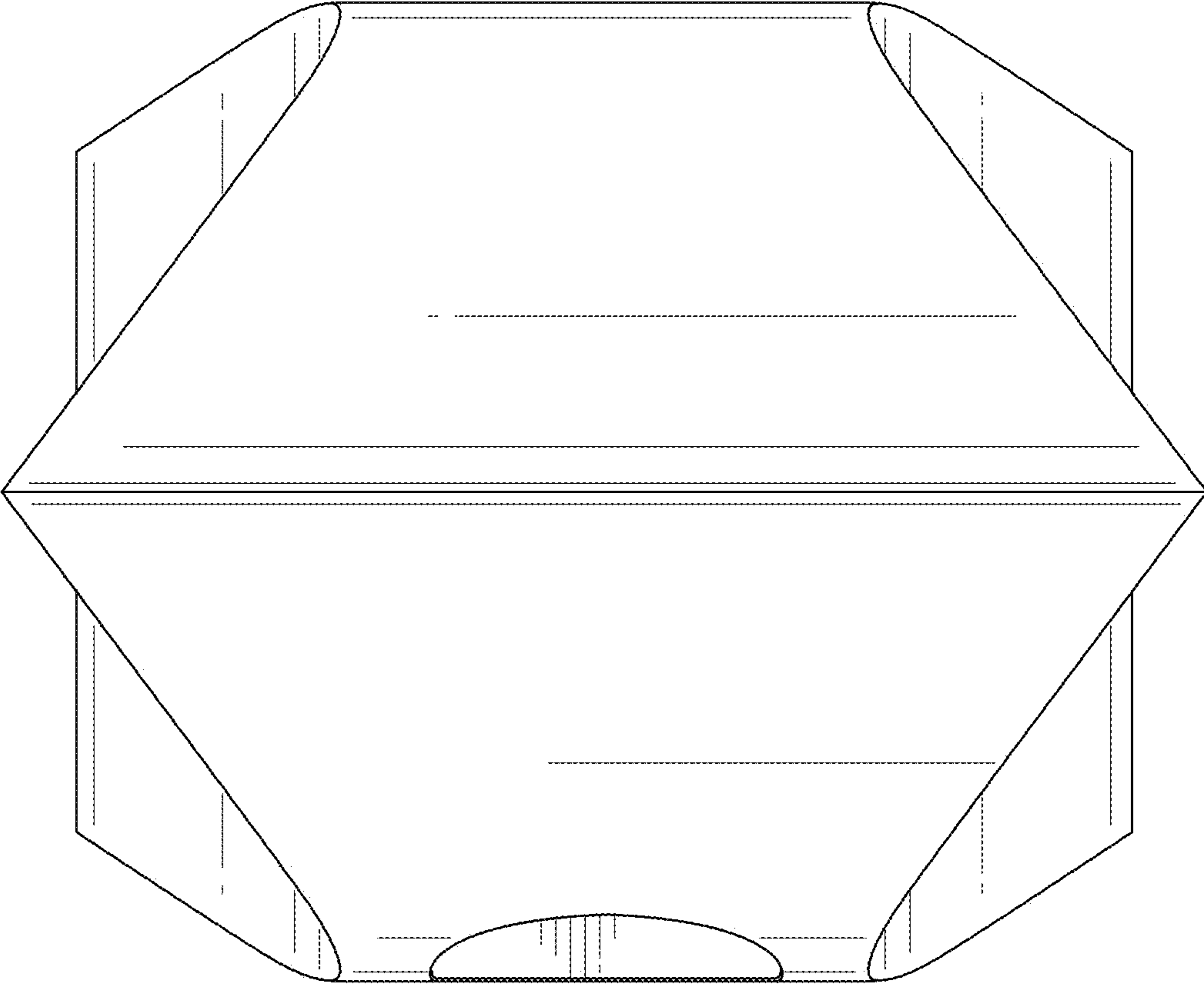

1.7

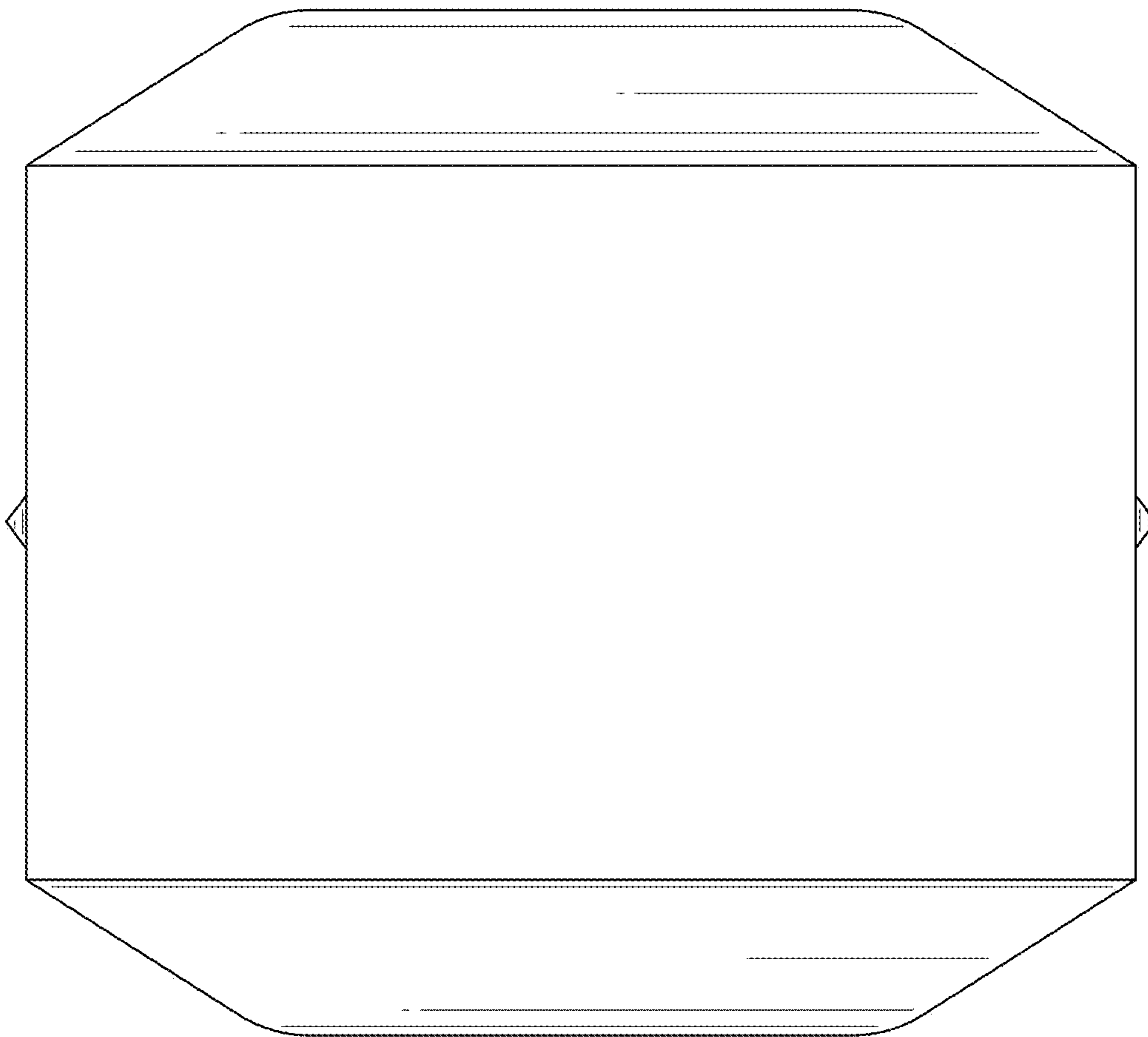

1.8

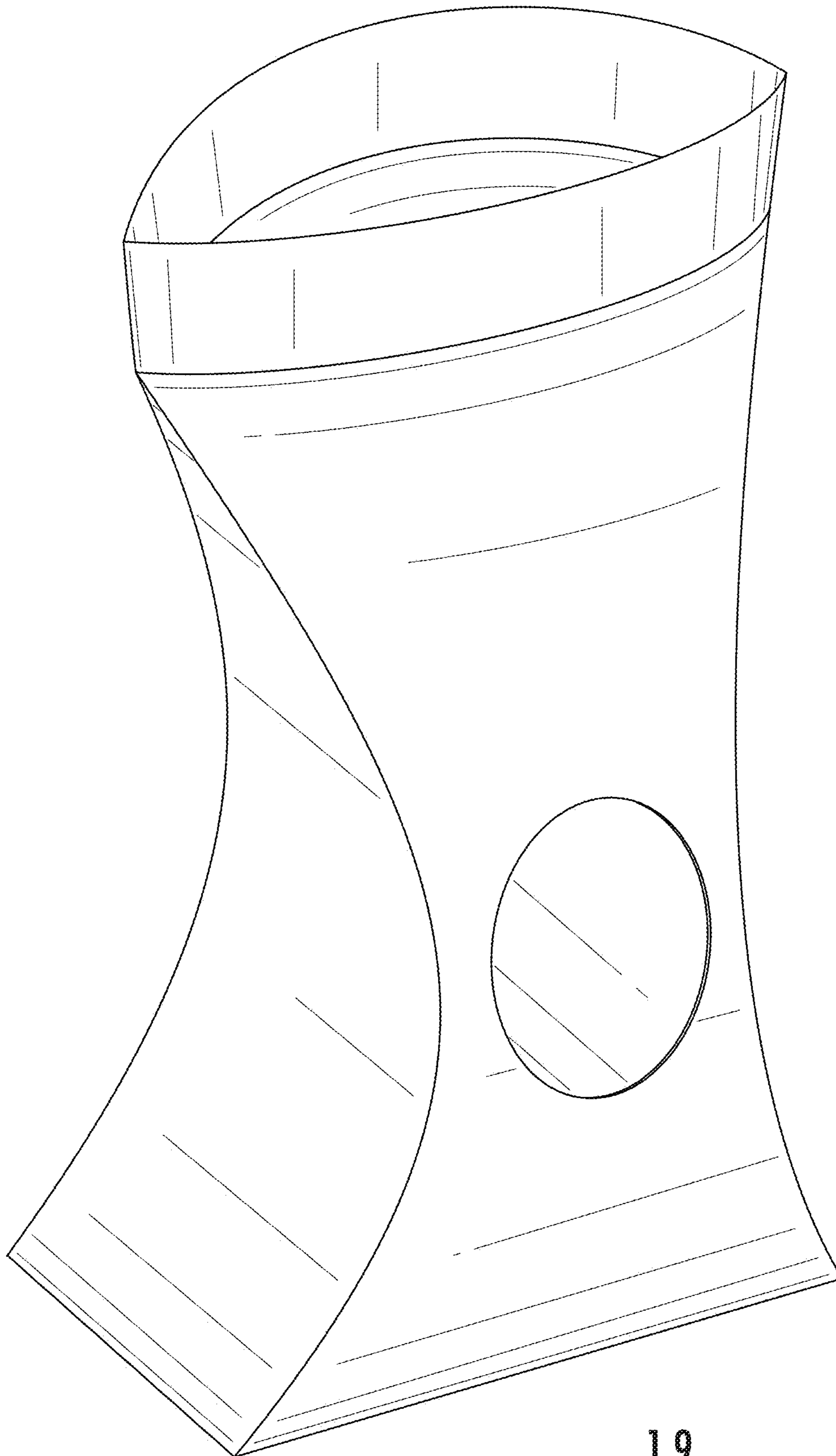

1.9

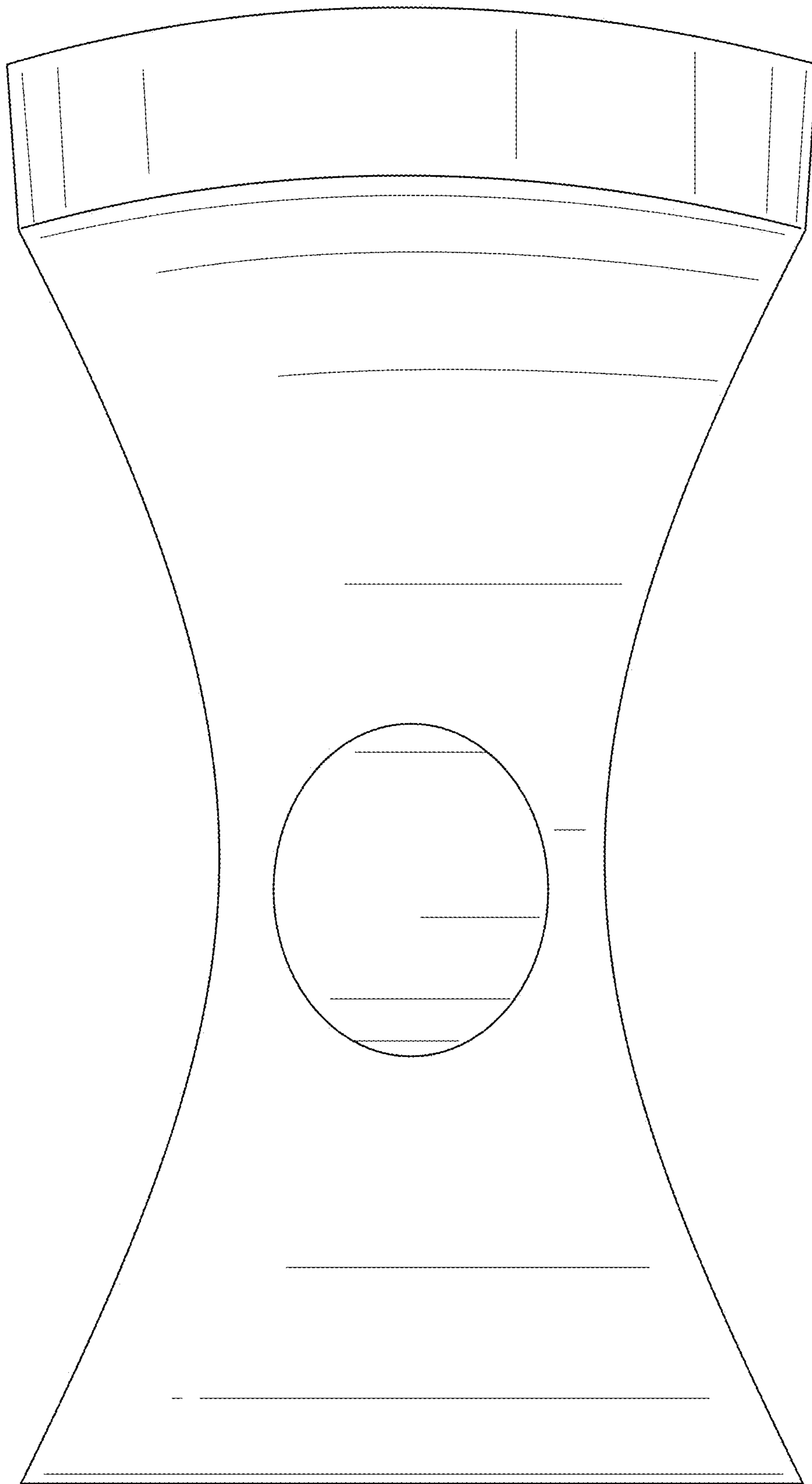

1.10



1.11

REPLACEMENT SHEET

12/14

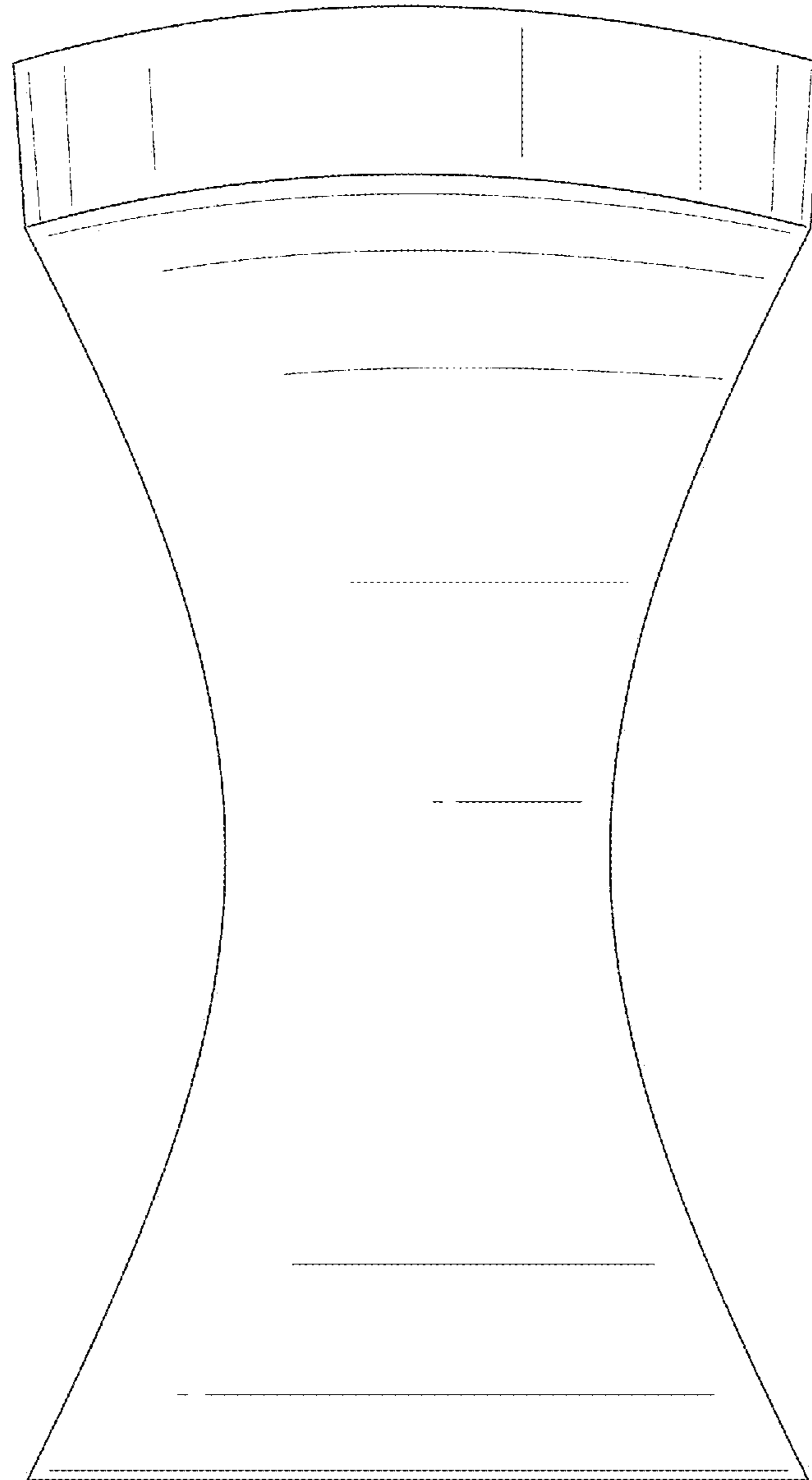

1.12

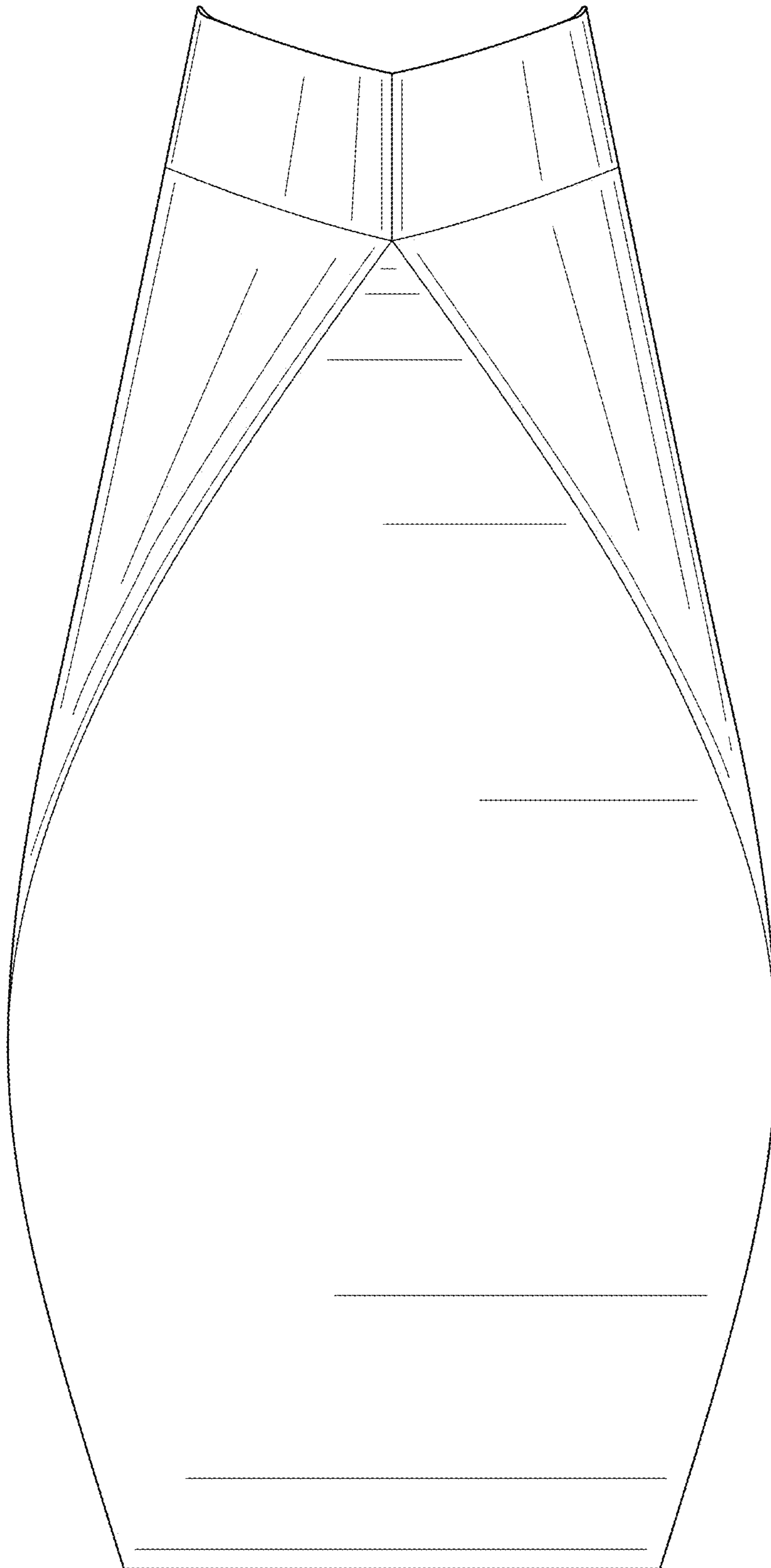

1.13

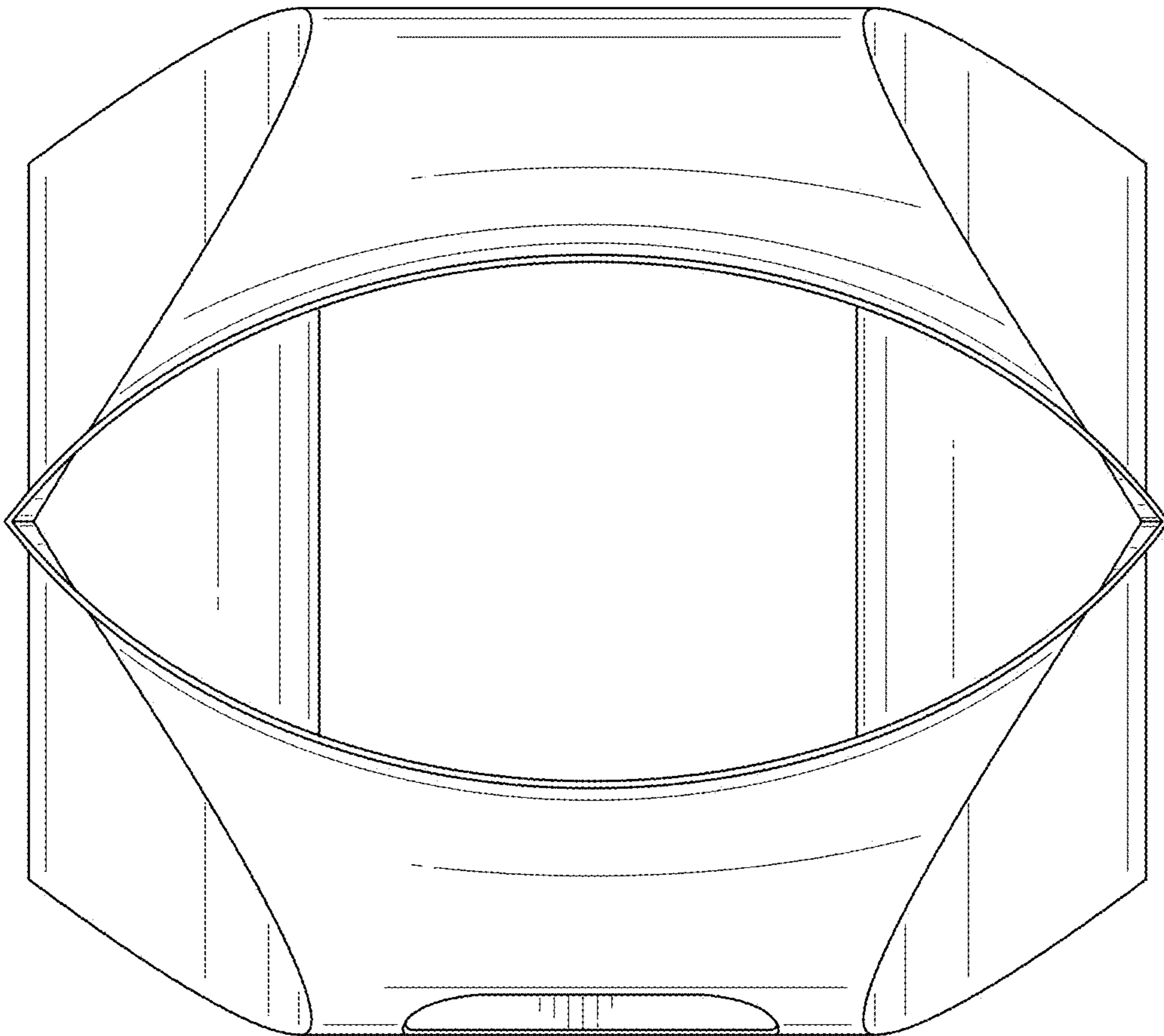

1.14