



US00D913266S

(12) **United States Design Patent** (10) **Patent No.:** **US D913,266 S**
Pantel (45) **Date of Patent:** **** Mar. 16, 2021**

(54) **SMARTPHONE**
 (71) Applicant: **Lothar Pantel**, Neckargemuend (DE)
 (72) Inventor: **Lothar Pantel**, Neckargemuend (DE)
 (73) Assignee: **inodyn NewMedia GmbH**,
 Neckargemuend (DE)
 (**) Term: **15 Years**
 (21) Appl. No.: **29/655,226**
 (22) Filed: **Jul. 1, 2018**

Related U.S. Application Data

(63) Continuation-in-part of application No. 29/644,284, filed on Apr. 16, 2018.

(30) **Foreign Application Priority Data**

May 31, 2018 (EM) 005291838

(51) **LOC (13) Cl.** **14-03**

(52) **U.S. Cl.**
USPC **D14/248**

(58) **Field of Classification Search**

USPC D14/248, 315-318, 341, 342, 345, 203.1,
 D14/203.3, 203.7, 371, 496, 388, 389,
 D14/507, 165, 250; D6/308, 310
 CPC G06F 1/1613; G06F 1/1647; G06F 1/1641;
 G06F 3/04883; G06F 3/0486; G06F
 3/04847; G06F 3/04845; G06F 3/04817;
 G06F 3/0484; H04M 1/0279; H04M
 1/0281; H04M 1/0283

See application file for complete search history.

(56) **References Cited**

U.S. PATENT DOCUMENTS

D645,833 S 9/2011 Seflic et al.
 D665,763 S 8/2012 Tsai et al.
 D693,787 S 11/2013 Reivo et al.
 D695,250 S 12/2013 Kim et al.
 D703,644 S * 4/2014 Song D14/248

D717,263 S 11/2014 Wozniak
 D726,673 S * 4/2015 Lee D14/138 G
 D730,863 S 6/2015 Yamagishi et al.
 D734,326 S 7/2015 McManigal
 D738,027 S * 9/2015 Wang D26/85
 D738,840 S * 9/2015 Kim D14/138 G
 D747,694 S * 1/2016 Tom D14/138 G
 D747,713 S 1/2016 Choi et al.
 D749,551 S 2/2016 Mitchell
 D752,040 S 3/2016 Cebe et al.
 D762,628 S 8/2016 Yoon et al.
 D763,837 S * 8/2016 Choe D14/248
 9,405,391 B1 8/2016 Mackraz
 D767,563 S 9/2016 Satzger et al.
 D772,835 S 11/2016 Kim et al.
 D775,597 S 1/2017 Kim et al.
 D776,108 S 1/2017 Hsu
 D777,700 S 1/2017 Kwon et al.
 D780,147 S 2/2017 Song
 D780,710 S 3/2017 Song
 D783,565 S 4/2017 Kim et al.
 D783,566 S 4/2017 Kim et al.
 D783,586 S * 4/2017 Park D14/248
 D784,281 S 4/2017 Ryu et al.
 D784,314 S 4/2017 Ryu et al.
 D786,214 S 5/2017 Kwon et al.
 D788,731 S 6/2017 Park et al.
 D791,730 S * 7/2017 Li D14/138 G
 D794,004 S 8/2017 Kwon et al.
 D794,623 S 8/2017 Kwon et al.
 D798,263 S 9/2017 Kwon et al.
 D810,713 S 2/2018 Pantel
 D820,232 S * 6/2018 Shin D14/138 G
 D820,800 S * 6/2018 Song D14/138 G
 D820,831 S * 6/2018 Kim D14/341
 D820,832 S * 6/2018 Kim D14/341
 D820,835 S * 6/2018 Kim D14/341
 D821,389 S * 6/2018 Kim D14/341
 D827,637 S * 9/2018 Kim D14/341
 D829,206 S * 9/2018 Akana D14/341
 D830,987 S * 10/2018 Choe D14/138 G
 D834,552 S * 11/2018 Ryu D14/138 G
 D836,592 S * 12/2018 Cho D14/138 AA
 D840,962 S * 2/2019 Song D14/138 G
 D840,964 S * 2/2019 Song D14/138 G
 D847,128 S 4/2019 Kim et al.
 D847,809 S * 5/2019 Akana D14/341
 D849,705 S * 5/2019 Boucquey D14/138 AA
 D850,402 S * 6/2019 Cho D14/138 G
 D851,085 S * 6/2019 Kim D14/341
 D853,980 S * 7/2019 Kim D14/138 G
 D854,524 S 7/2019 Choi et al.
 D857,009 S * 8/2019 Kim D14/341

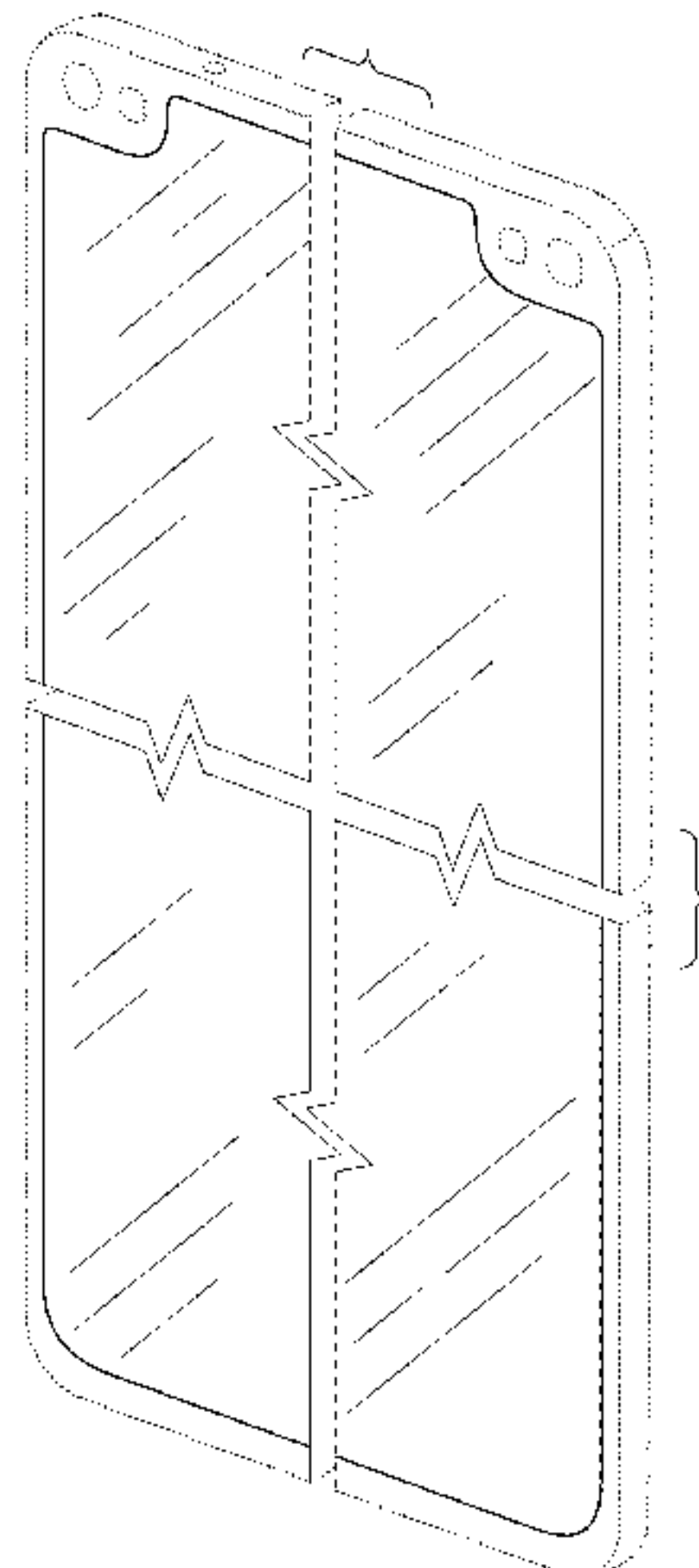

D857,690	S	*	8/2019	Kim	D14/341
D861,673	S	*	10/2019	Kim	D14/341
D861,674	S	*	10/2019	Kim	D14/341
D862,457	S	*	10/2019	Kim	D14/341
D862,458	S	*	10/2019	Kim	D14/341
D863,293	S	*	10/2019	Kim	D14/341
D864,197	S	*	10/2019	Kim	D14/341
D864,954	S	*	10/2019	Kim	D14/341
D865,732	S	*	11/2019	Park	D14/248
D865,734	S	*	11/2019	Park	D14/248
D865,735	S	*	11/2019	Park	D14/248
D866,499	S	*	11/2019	Shin	D14/138 G
D866,500	S	*	11/2019	Shin	D14/138 G
D866,540	S	*	11/2019	Park	D14/248
D866,549	S	*	11/2019	Kim	D14/341
D866,550	S	*	11/2019	Kim	D14/341
D872,044	S	*	1/2020	Lee	D14/138 G
D876,431	S	*	2/2020	Pendse	D14/341
2012/0032979	A1		2/2012	Blow et al.		
2014/0170397	A1		6/2014	Shen et al.		
2014/0325435	A1		10/2014	Jung et al.		
2015/0185055	A1*		7/2015	King	G01D 11/245 361/679.01
2015/0317020	A1		11/2015	Watanabe et al.		
2015/0364109	A1		12/2015	Jain et al.		
2016/0161664	A1		6/2016	Ishida et al.		
2017/0004798	A1		1/2017	Park et al.		
2017/0069956	A1*		3/2017	Hill	H04M 1/0249
2017/0123454	A1		5/2017	Evans, V et al.		
2017/0123575	A1		5/2017	Evans, V et al.		
2017/0126868	A1		5/2017	Evans, V et al.		
2017/0126979	A1		5/2017	Evans, V et al.		
2017/0162111	A1		6/2017	Kang et al.		

FOREIGN PATENT DOCUMENTS

AU	201716792	S	11/2017
AU	201716793	S	11/2017
DE	402017202114	S	10/2017
DE	402017203592	S	2/2018
DE	402017203595	S	2/2018
EM	004013787	S	7/2017
EM	004494417	S	11/2017
GB	6032901	S	4/2018
GB	6032902	S	4/2018
GB	6032903	S	4/2018
GB	6032904	S	4/2018
GB	6032905	S	4/2018
GB	6032906	S	4/2018
GB	6032907	S	4/2018
GB	6032908	S	4/2018
GB	6032909	S	4/2018
GB	6032910	S	4/2018
GB	6032911	S	4/2018
GB	6032912	S	4/2018
GB	6032913	S	4/2018
GB	6032914	S	4/2018
GB	6032915	S	4/2018
GB	6032916	S	4/2018
GB	6032917	S	4/2018
GB	6032918	S	4/2018
GB	6032919	S	4/2018
GB	6032920	S	4/2018

OTHER PUBLICATIONS

Early publication of UK patent application GB 2552090 A (UK IPO application No. 1710466.2) Inventor/author: Lothar Pantel; Title: "Front-facing camera and maximized display screen of a mobile device" Published by the inventor/applicant of the present application. Available online from: <http://www.earlypublication.com> Publication Date (on "earlypublication.com"): Jul. 3, 2017; Twelve-Month Grace Period Applies.
 Alex Hern, May 30, 2017, "Android co-founder reveals new smartphone to take on Apple and Samsung," The Guardian, Available online from: <https://www.theguardian.com/technology/2017/may/30/essential-phone-android-co-founder-reveals-new-smartphone-apple-samsung>.

Samuel Gibbs, Nov. 10, 2017, "iPhone X review: Apple finally knocks it out of the park," The Guardian, Available online from: <https://www.theguardian.com/technology/2017/nov/10/iphone-x-review-apple-face-id-all-screen-design-home-button>.

* cited by examiner

Primary Examiner — Garth Rademaker
Assistant Examiner — Benjamin M Weeks

(57) **CLAIM**

The ornamental design for a smartphone, as shown and described.

DESCRIPTION

This application is related to U.S. design application Ser. No. 29/539,390, filed Sep. 14, 2015, now U.S. Pat. No. D810,713 S, U.S. design application Ser. No. 29/624,858, filed Nov. 3, 2017, U.S. design application Ser. No. 29/624,864, filed Nov. 3, 2017, and U.S. design application Ser. No. 29/644,278, filed Apr. 16, 2018.

FIG. 1 is a top right front perspective view of a first embodiment of a smartphone showing my new design;
 FIG. 2 is a front elevation view thereof;
 FIG. 3 is a rear elevation view thereof;
 FIG. 4 is a left side elevation view thereof, the right side being a mirror image thereof;
 FIG. 5 is a top plan view thereof;
 FIG. 6 is a bottom plan view thereof;
 FIG. 7 is another front elevation view thereof, showing environment in a state of use;
 FIG. 8 is a top right front perspective view of a second embodiment thereof;
 FIG. 9 is a front elevation view thereof;
 FIG. 10 is a rear elevation view thereof;
 FIG. 11 is a left side elevation view thereof, the right side being a mirror image thereof;
 FIG. 12 is a top plan view thereof;
 FIG. 13 is a bottom plan view thereof;
 FIG. 14 is another front elevation view thereof, showing environment in a state of use;
 FIG. 15 is a top right front perspective view of a third embodiment thereof;
 FIG. 16 is a front elevation view thereof;
 FIG. 17 is a rear elevation view thereof;
 FIG. 18 is a left side elevation view thereof, the right side being a mirror image thereof;
 FIG. 19 is a top plan view thereof;
 FIG. 20 is a bottom plan view thereof;
 FIG. 21 is another front elevation view thereof, showing environment in a state of use;
 FIG. 22 is a top right front perspective view of a fourth embodiment thereof;
 FIG. 23 is a front elevation view thereof;
 FIG. 24 is a rear elevation view thereof;
 FIG. 25 is a left side elevation view thereof, the right side being a mirror image thereof;
 FIG. 26 is a top plan view thereof;
 FIG. 27 is a bottom plan view thereof;
 FIG. 28 is another front elevation view thereof, showing environment in a state of use;
 FIG. 29 is a top right front perspective view of a fifth embodiment thereof;
 FIG. 30 is a front elevation view thereof;
 FIG. 31 is a rear elevation view thereof;

FIG. 32 is a left side elevation view thereof, the right side being a mirror image thereof;

FIG. 33 is a top plan view thereof;

FIG. 34 is a bottom plan view thereof;

FIG. 35 is another front elevation view thereof, showing environment in a state of use;

FIG. 36 is a top right front perspective view of a sixth embodiment thereof;

FIG. 37 is a front elevation view thereof;

FIG. 38 is a rear elevation view thereof;

FIG. 39 is a left side elevation view thereof, the right side being a mirror image thereof;

FIG. 40 is a top plan view thereof;

FIG. 41 is a bottom plan view thereof; and,

FIG. 42 is another front elevation view thereof, showing environment in a state of use.

Features shown in broken or dotted lines as well as break lines and associated curly brackets form no part of the claimed design. Oblique shade lines show a transparent, reflective, or shiny surface, and not surface ornamentation. The break lines in the drawings indicate undetermined length and width of the claimed design, and the appearance of any portion of the smartphone between the break lines forms no part of the claimed design.

1 Claim, 24 Drawing Sheets

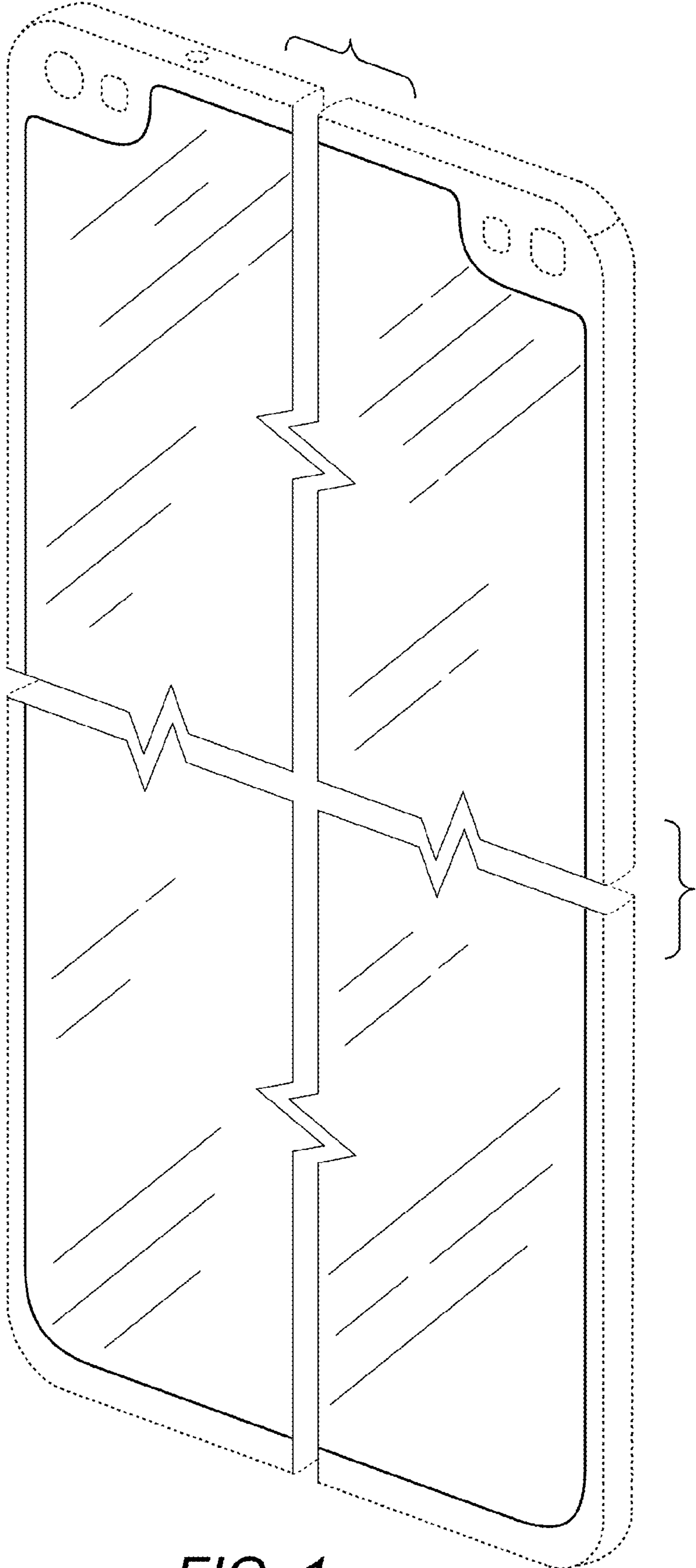

FIG. 1

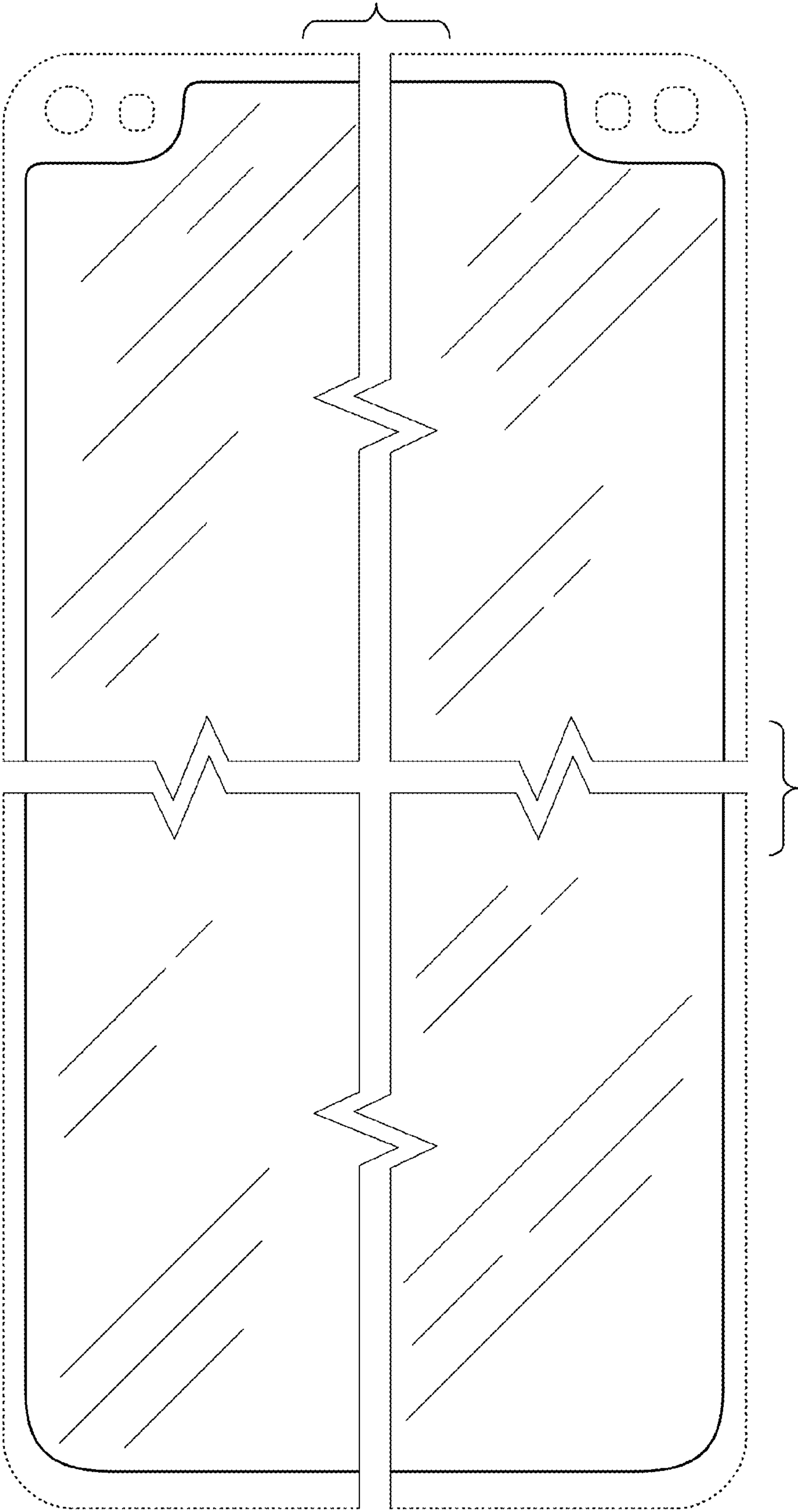

FIG. 2

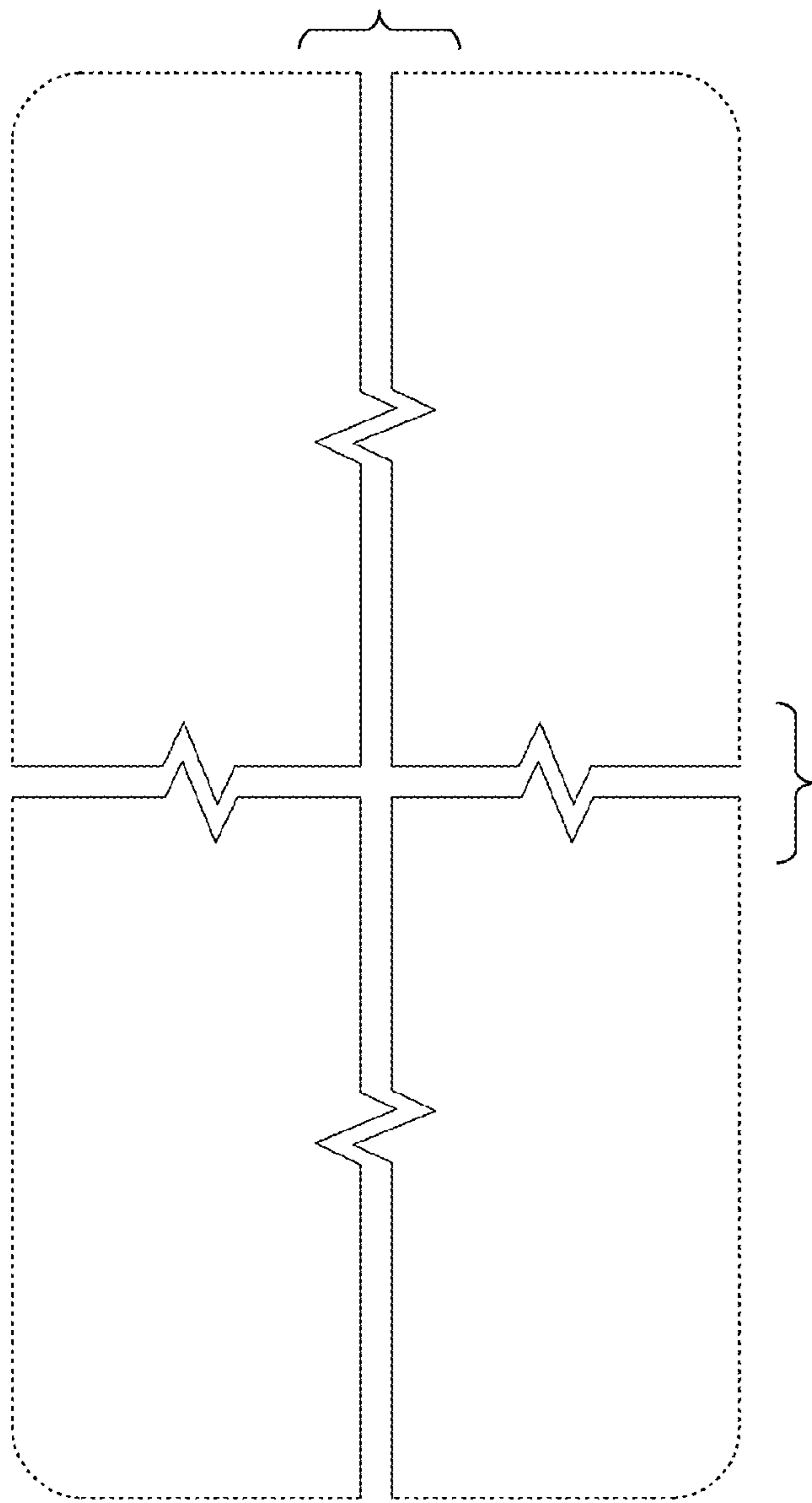

FIG. 3



FIG. 4

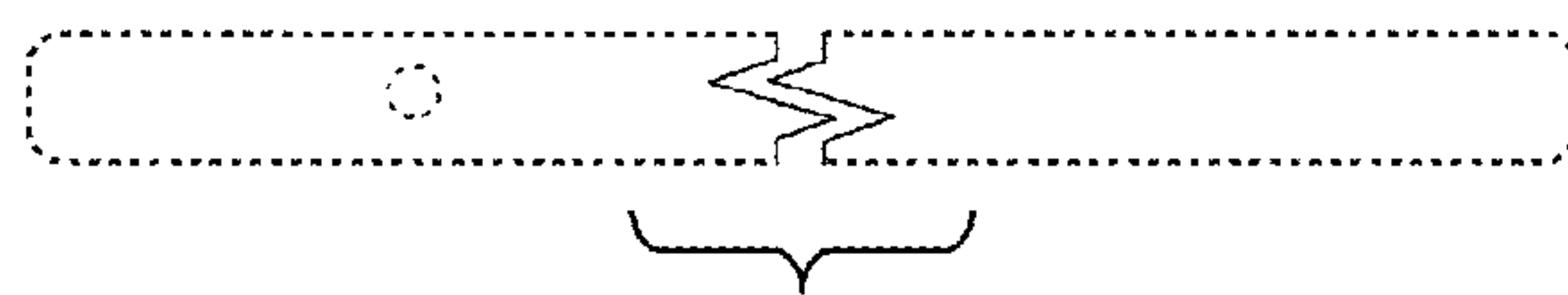

FIG. 5

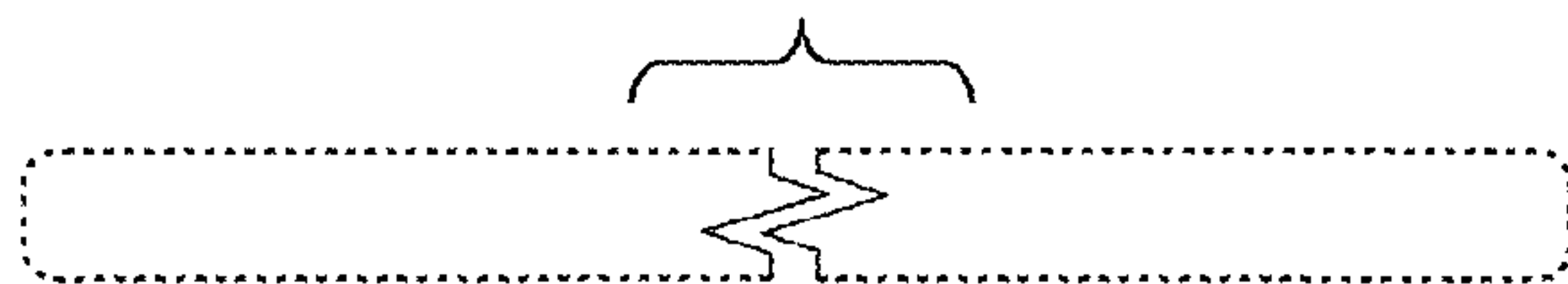

FIG. 6

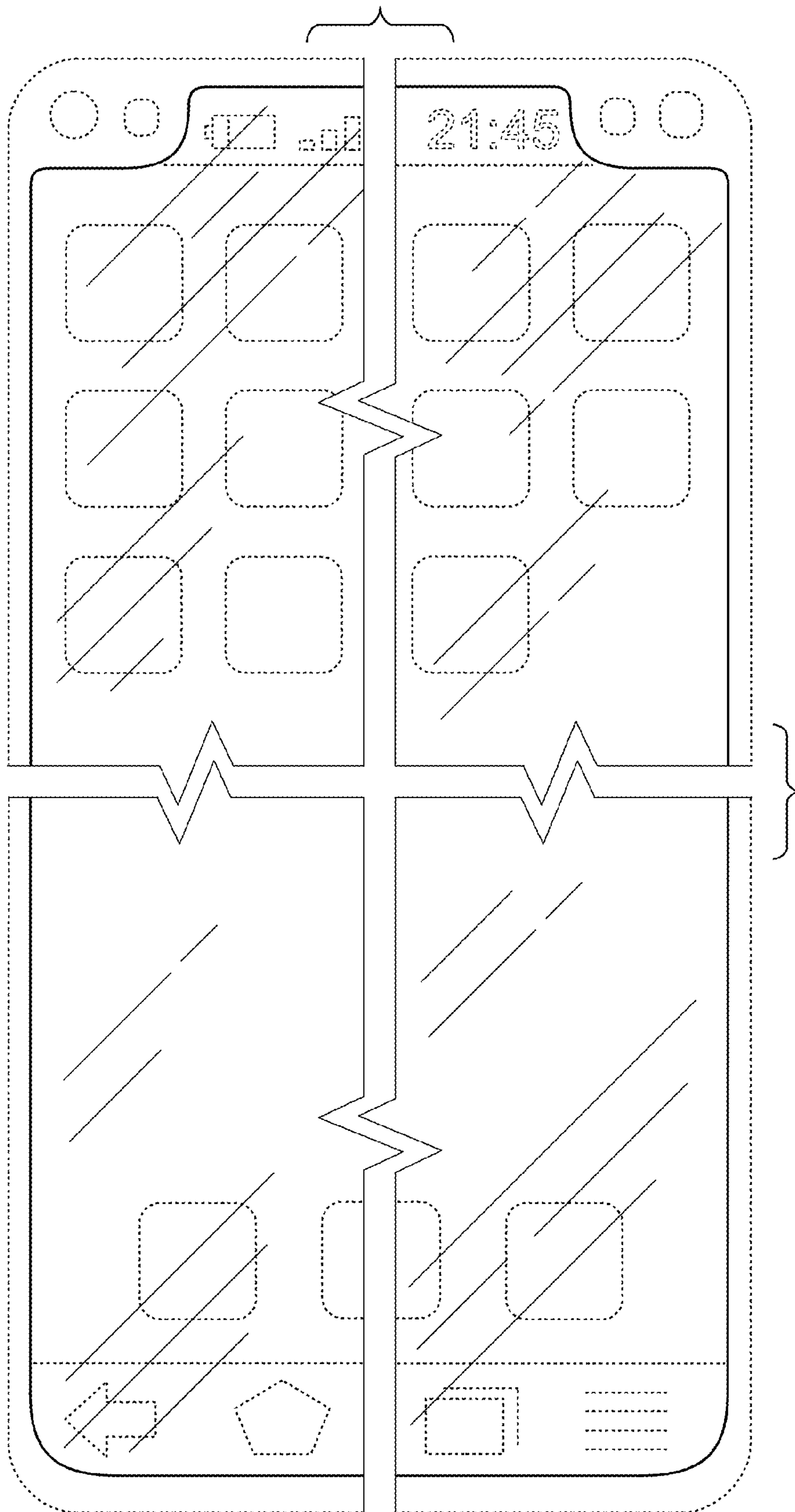

FIG. 7

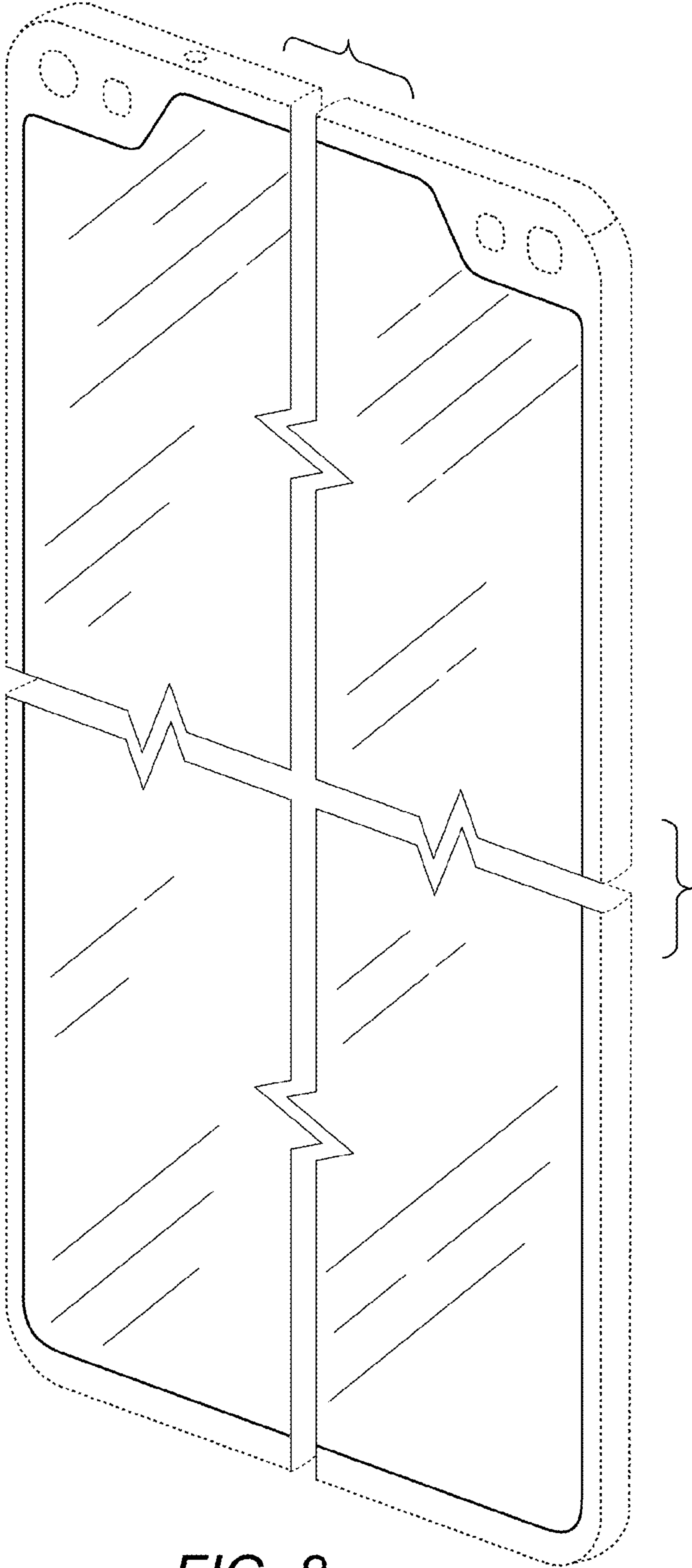

FIG. 8

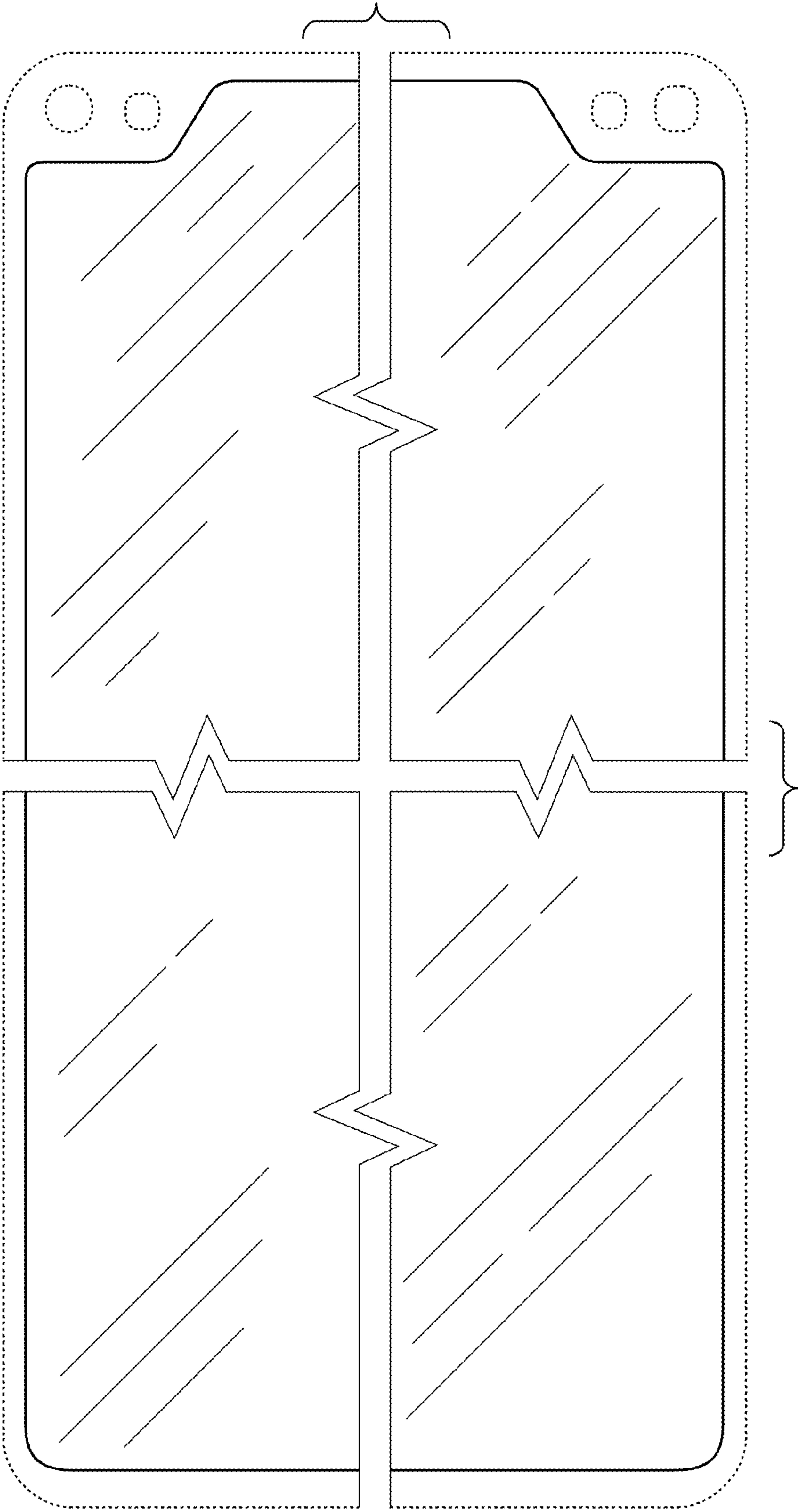

FIG. 9

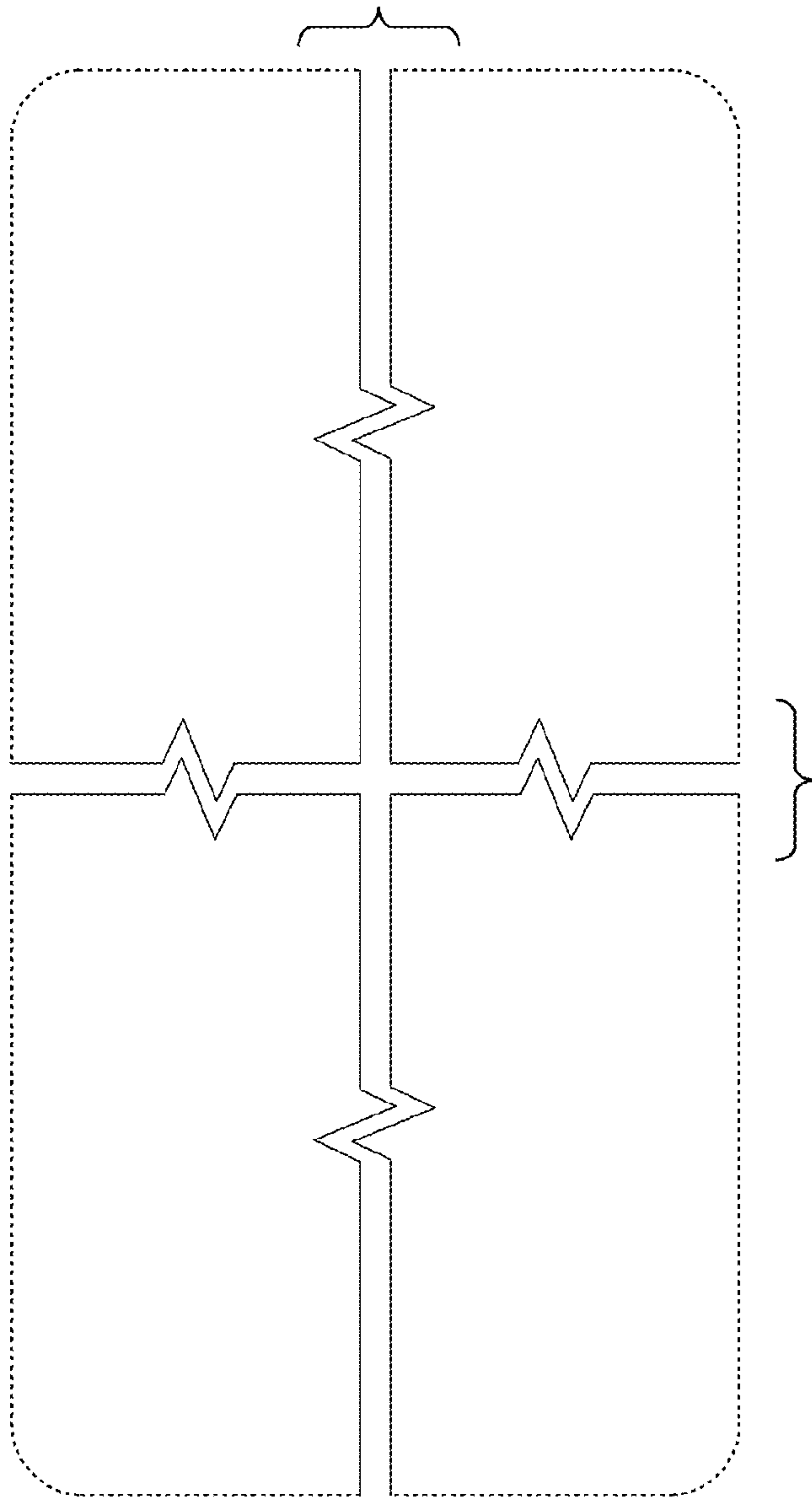

FIG. 10

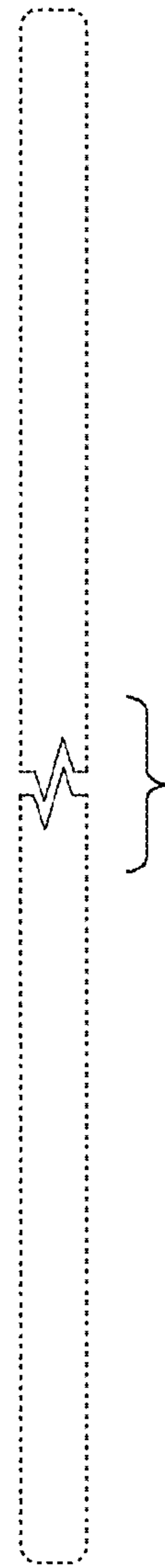

FIG. 11

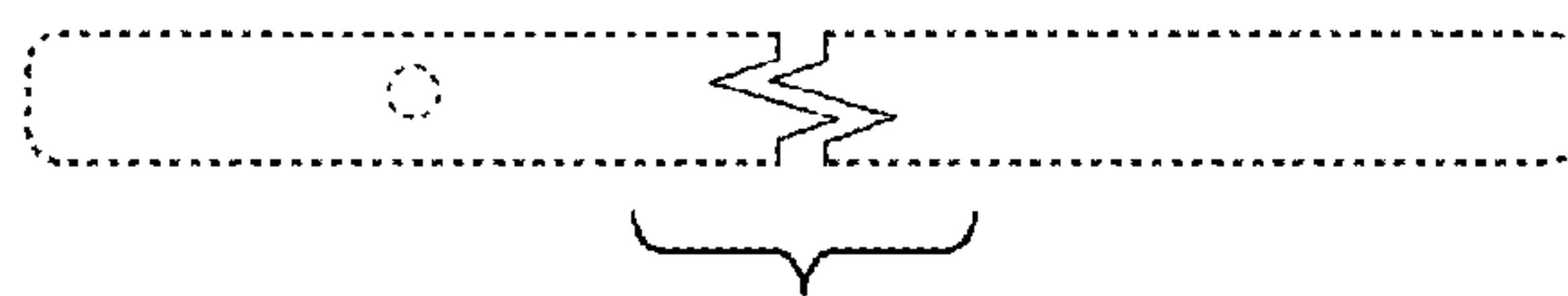

FIG. 12

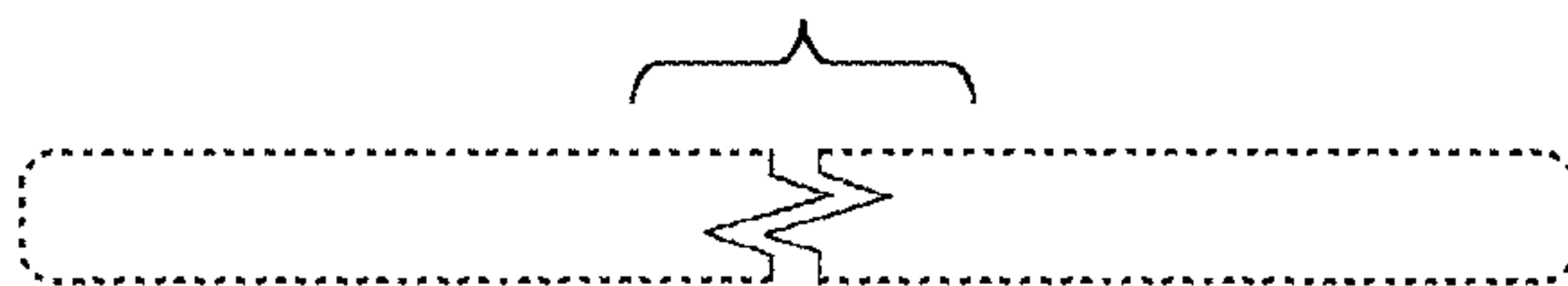

FIG. 13

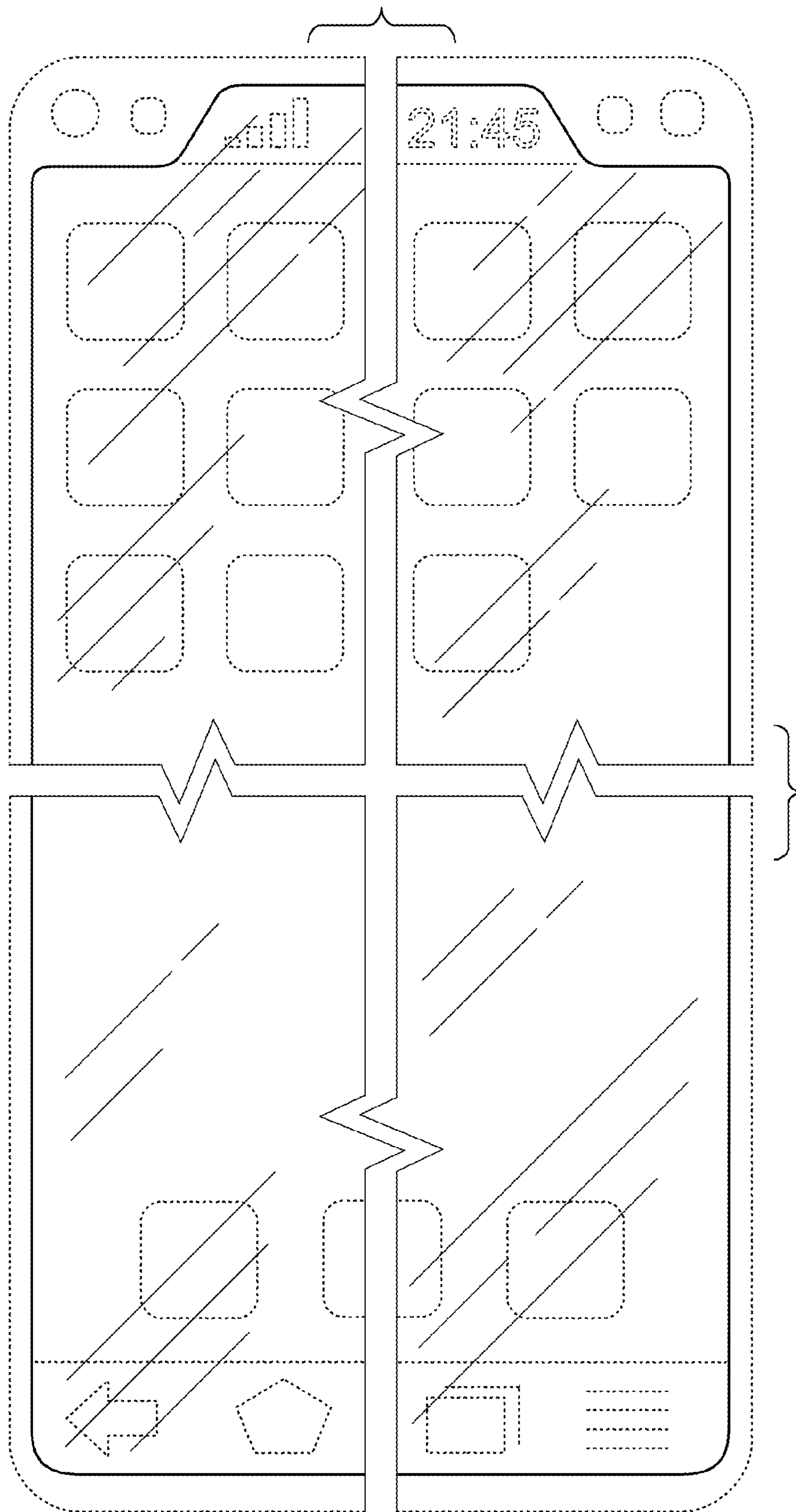

FIG. 14

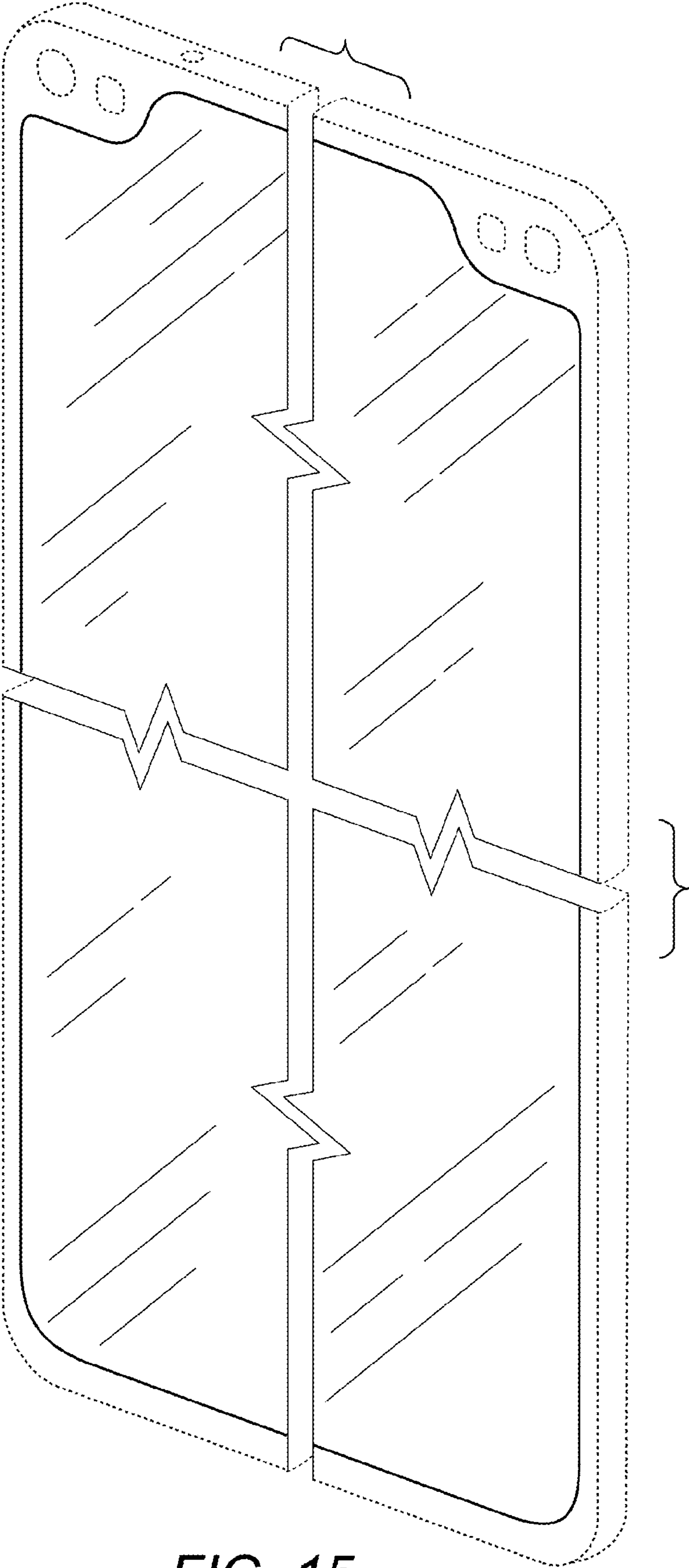

FIG. 15

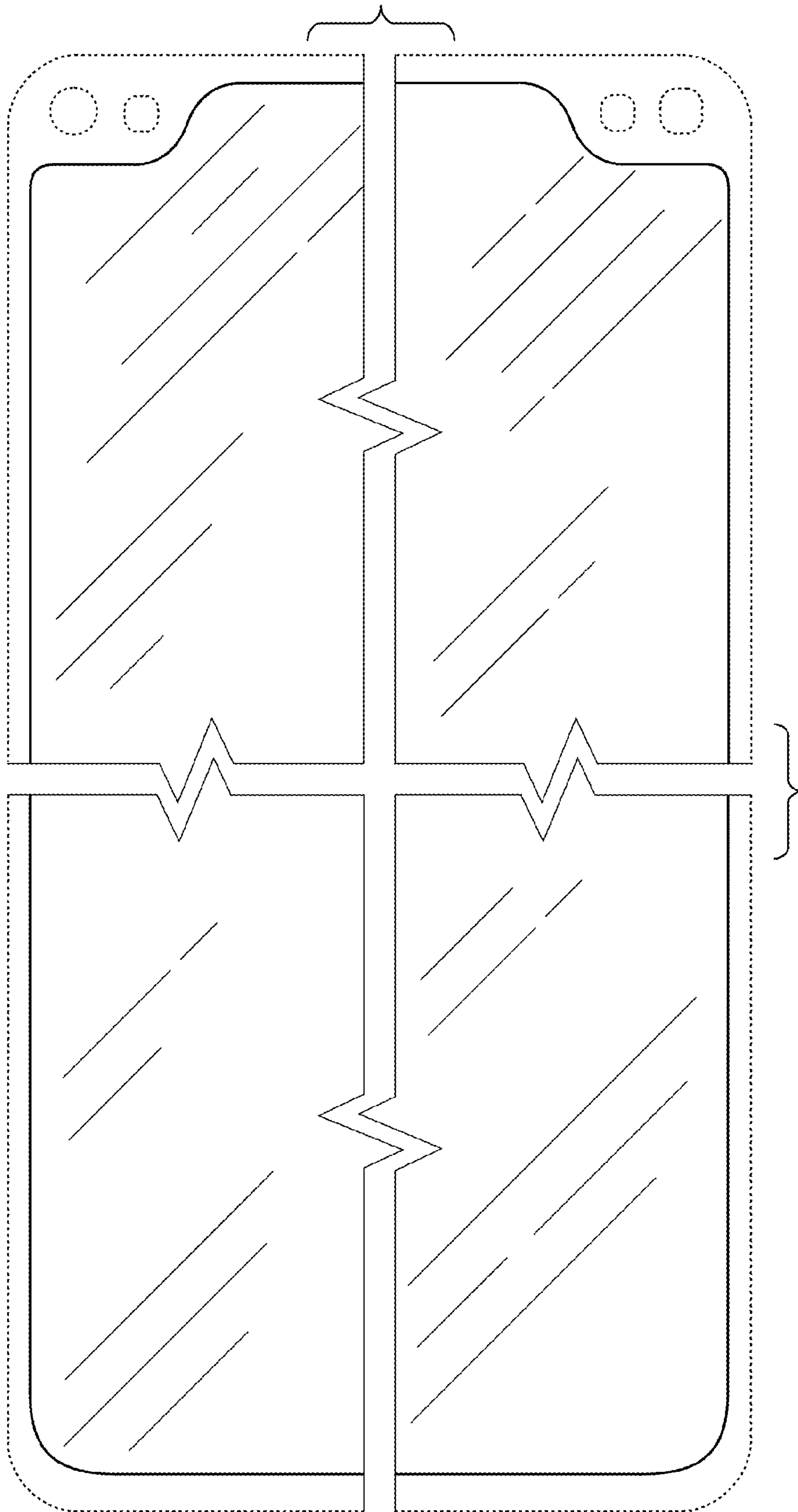

FIG. 16

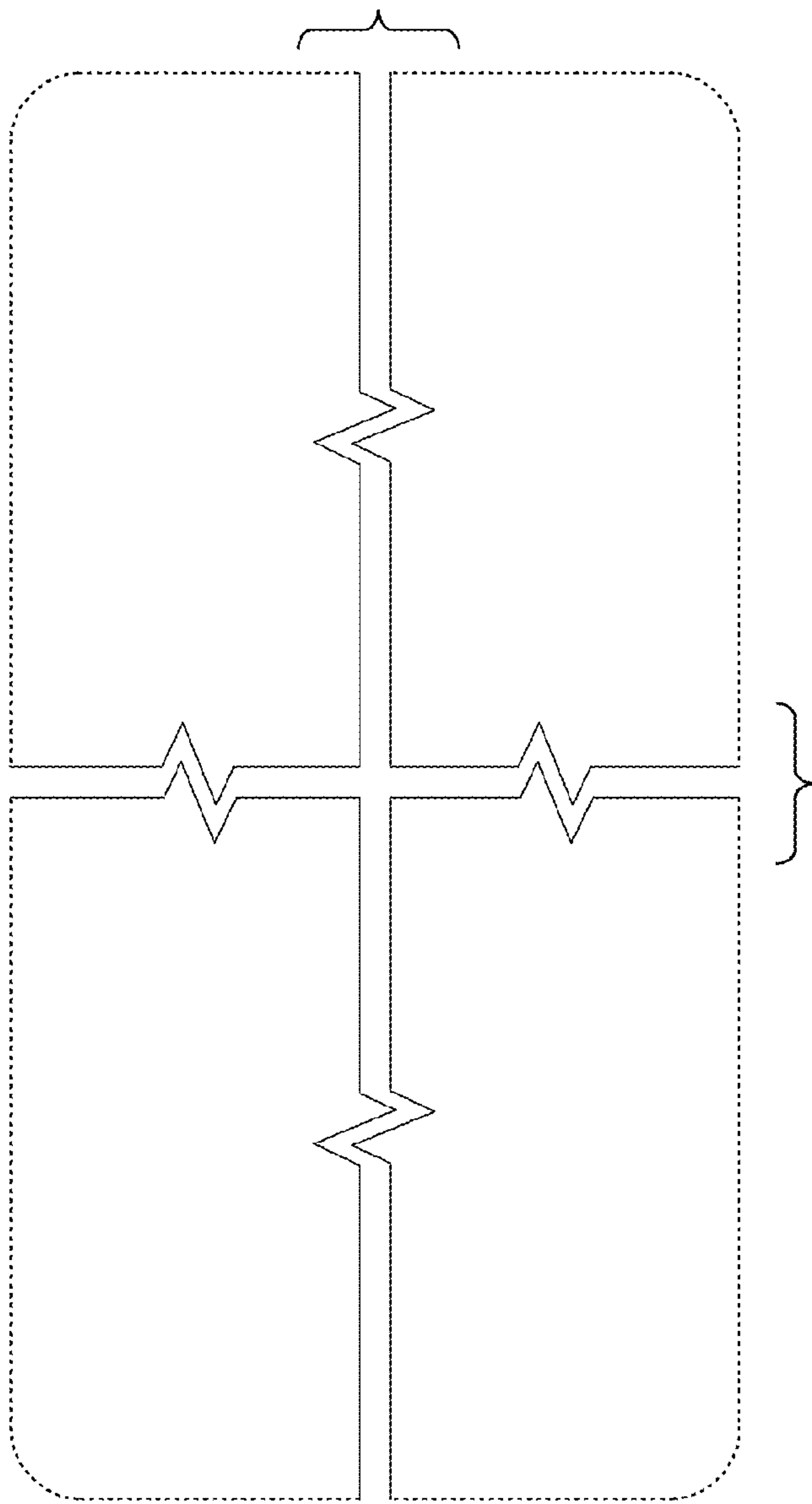

FIG. 17

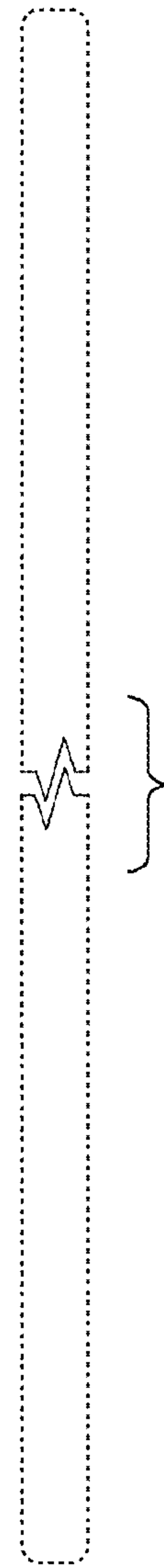

FIG. 18

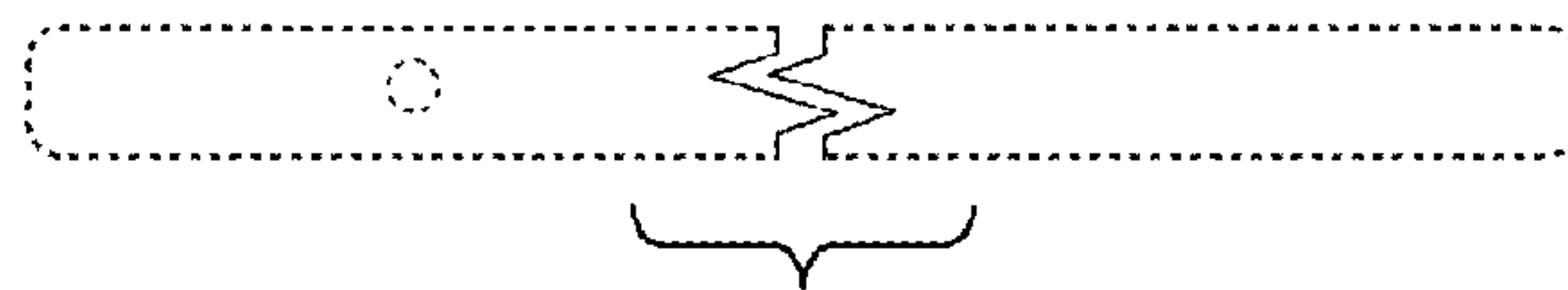

FIG. 19

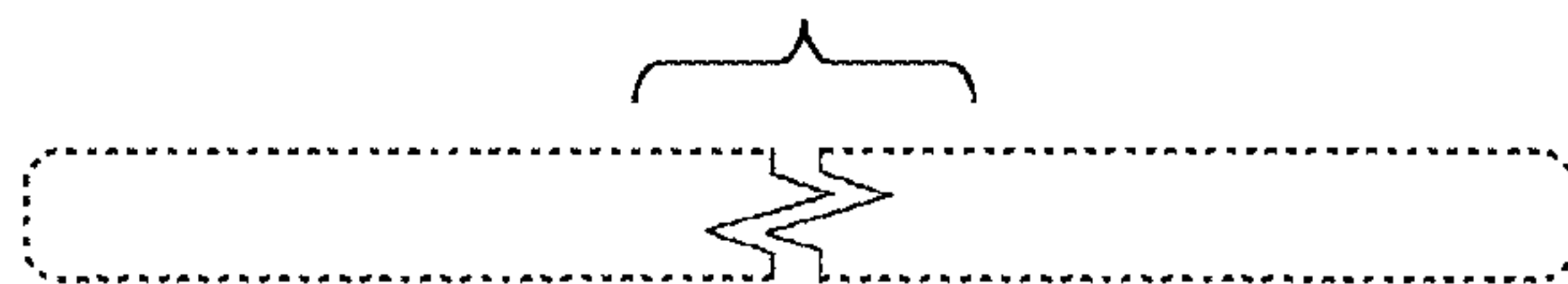

FIG. 20

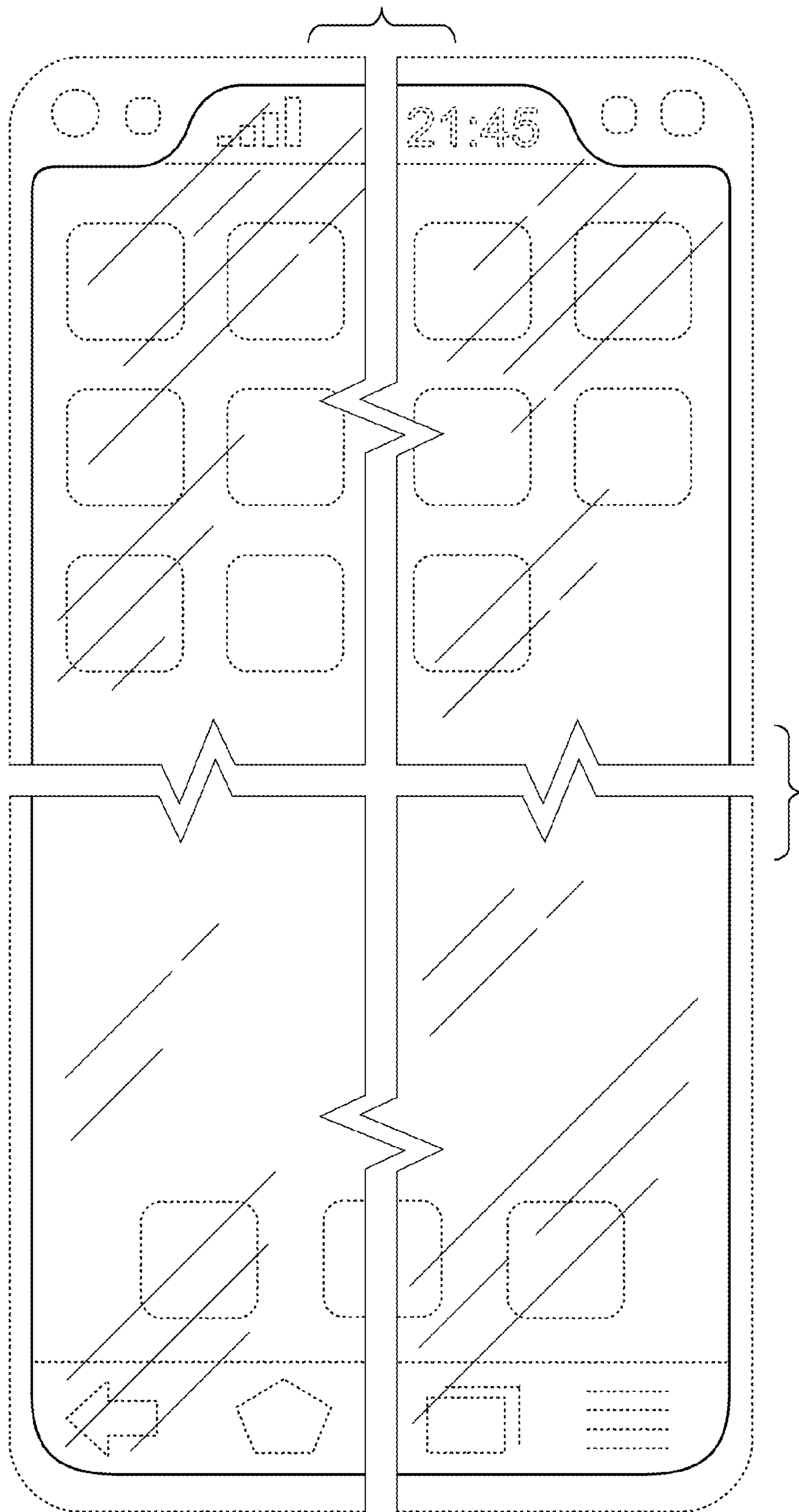

FIG. 21

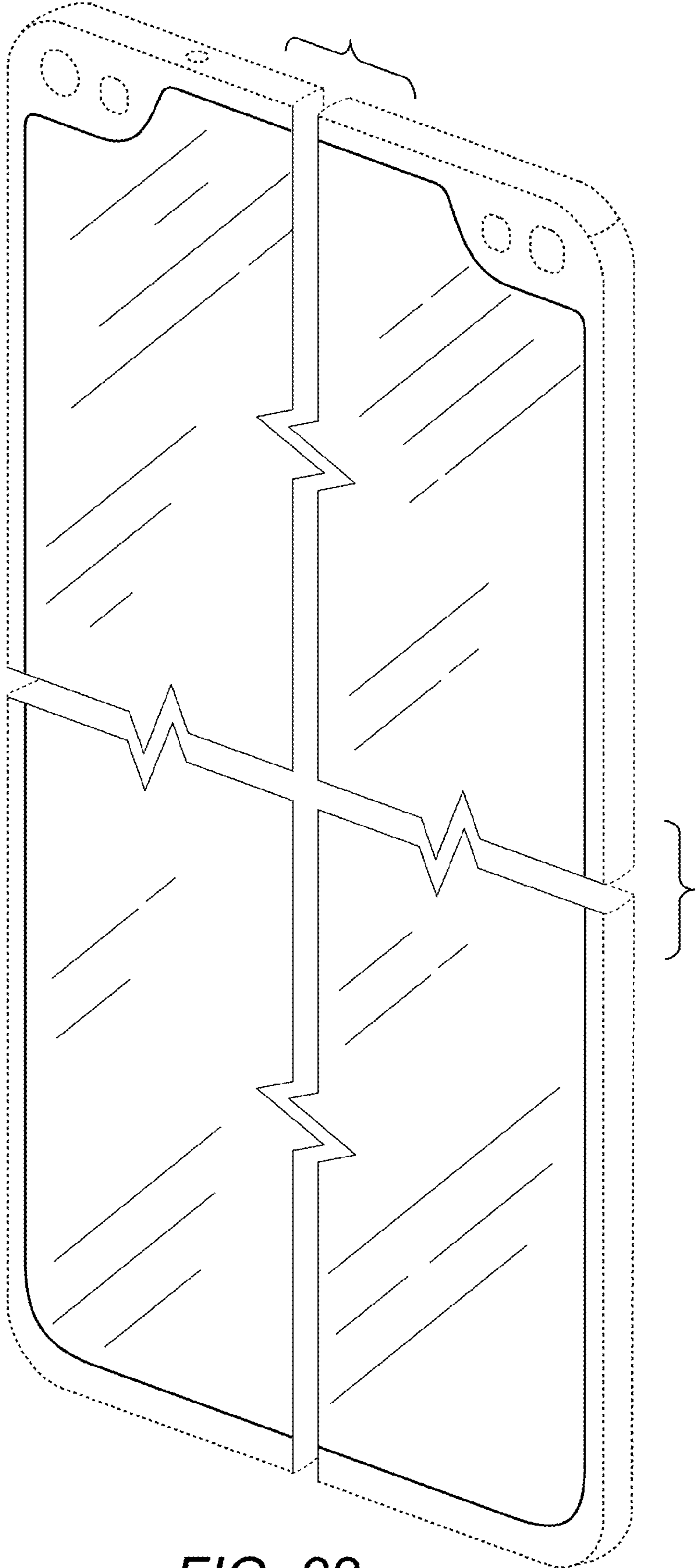

FIG. 22

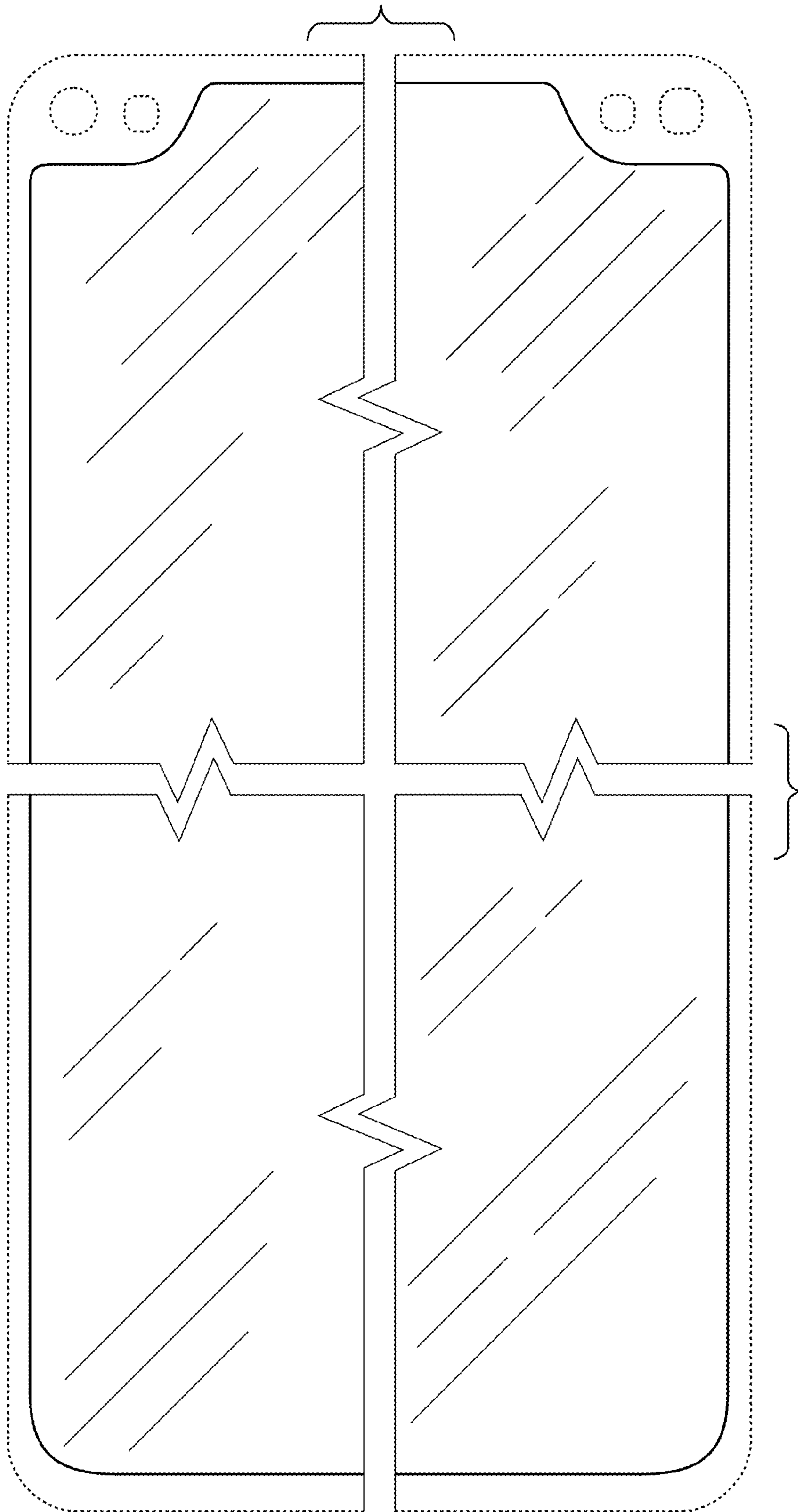

FIG. 23

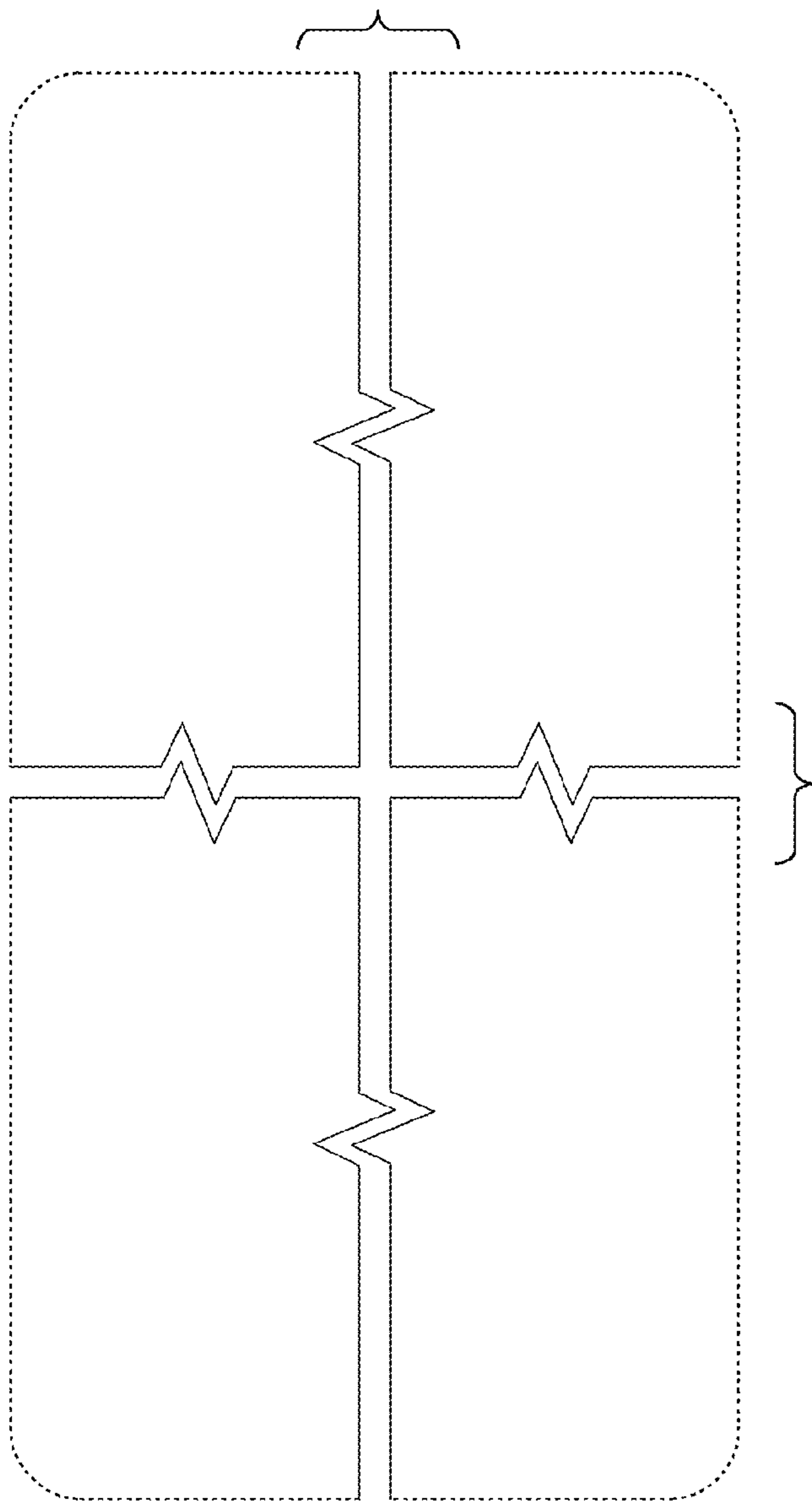

FIG. 24



FIG. 25

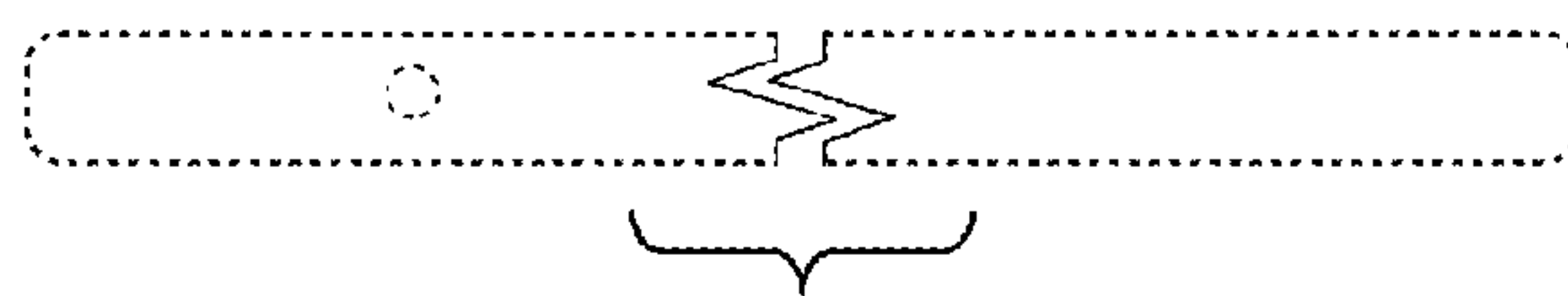

FIG. 26

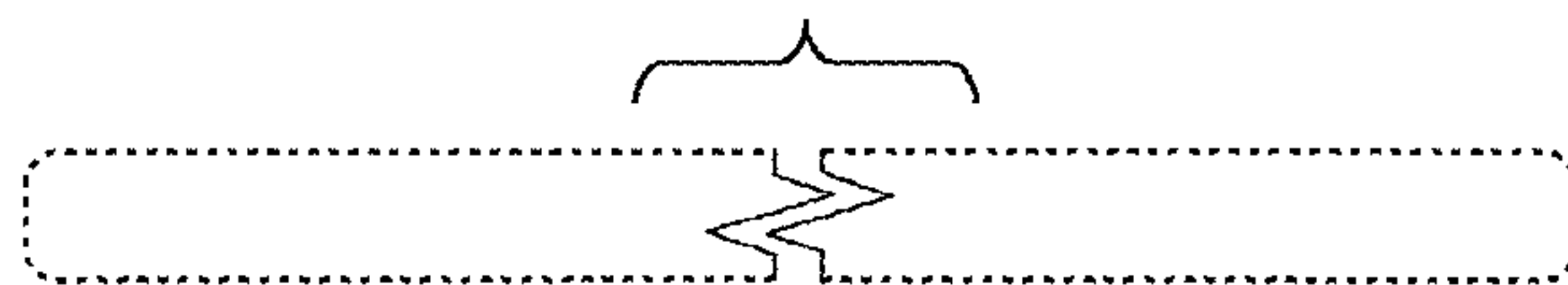

FIG. 27

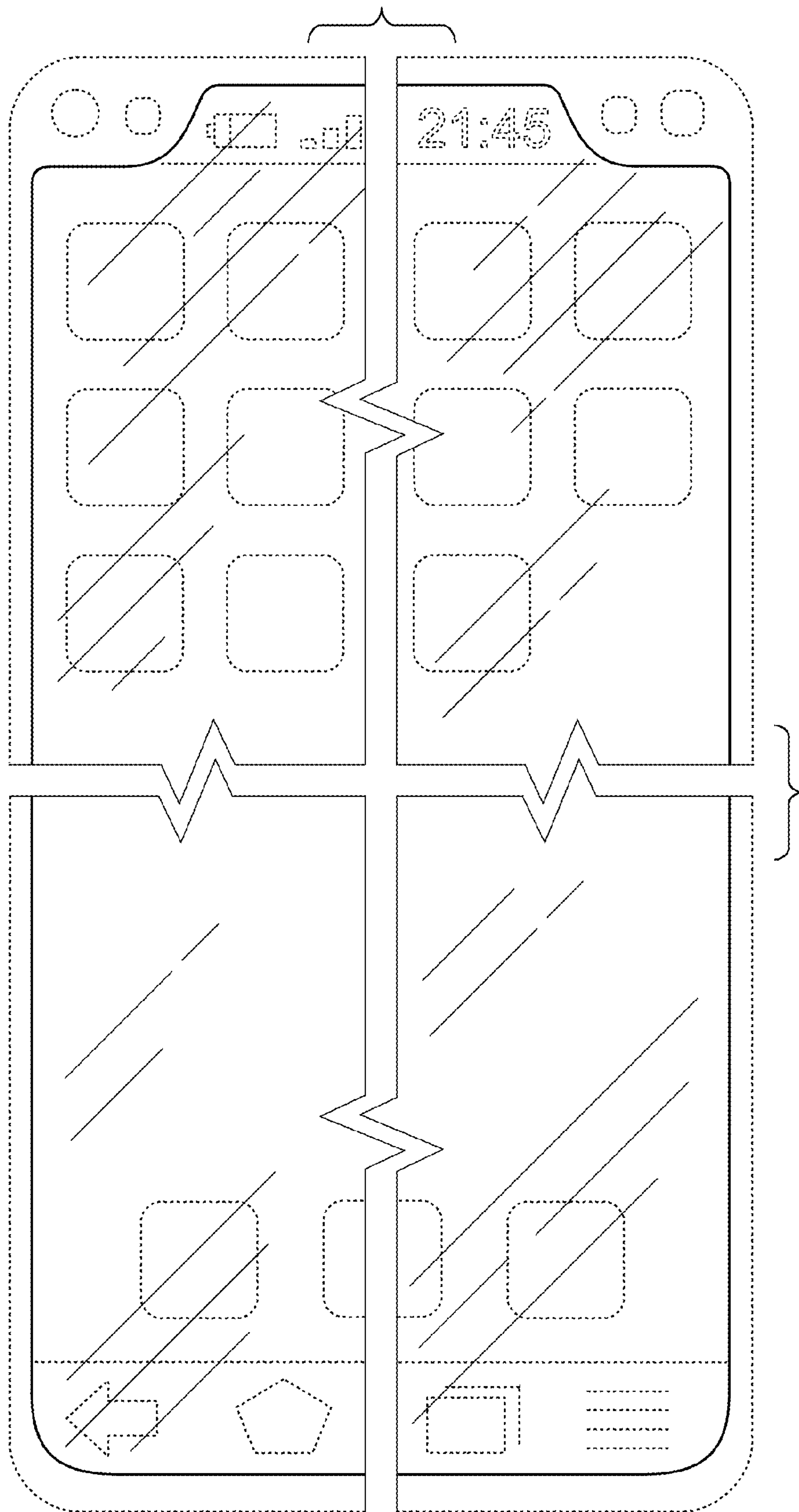

FIG. 28

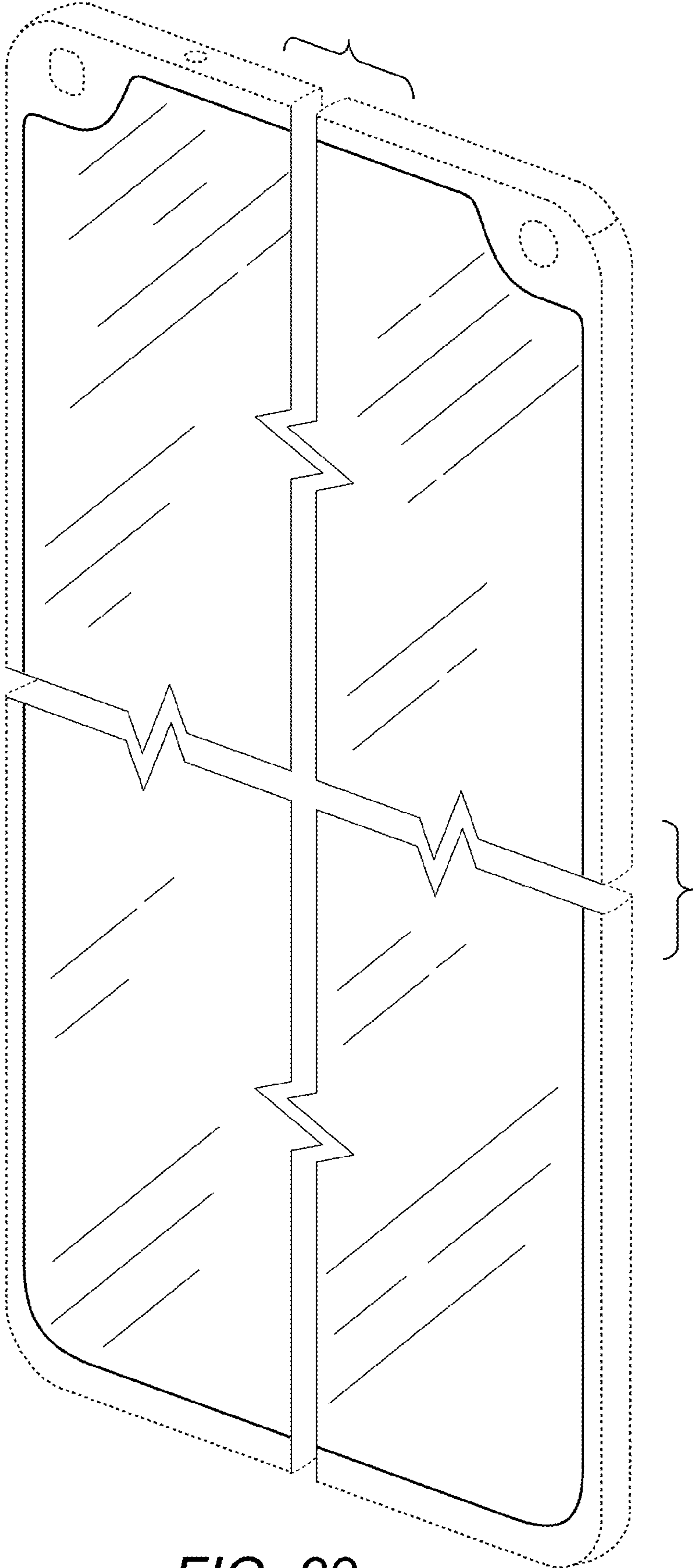

FIG. 29

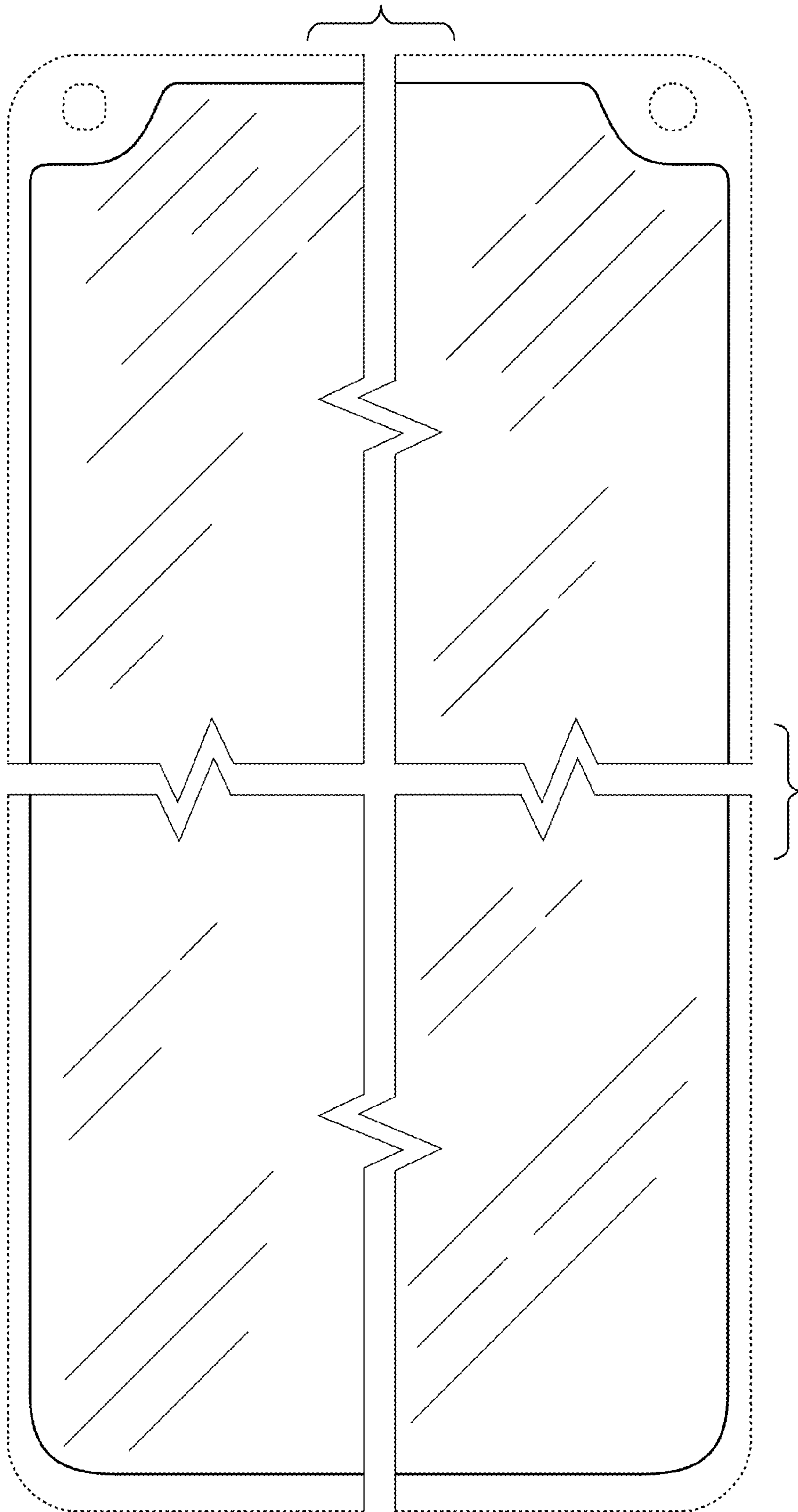

FIG. 30

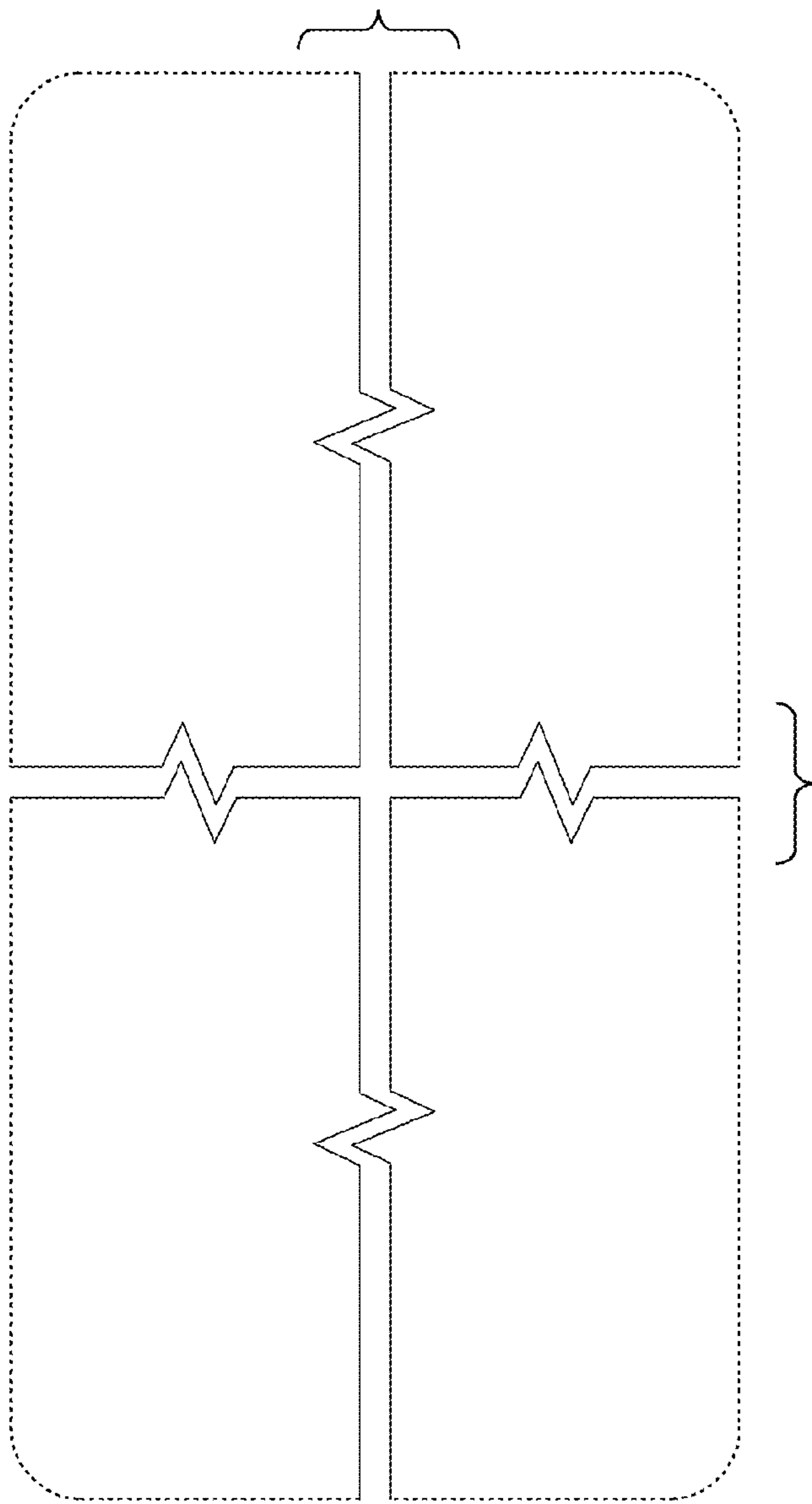

FIG. 31

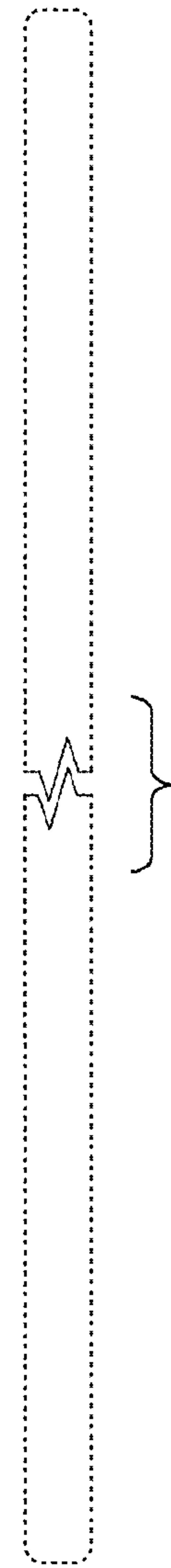

FIG. 32

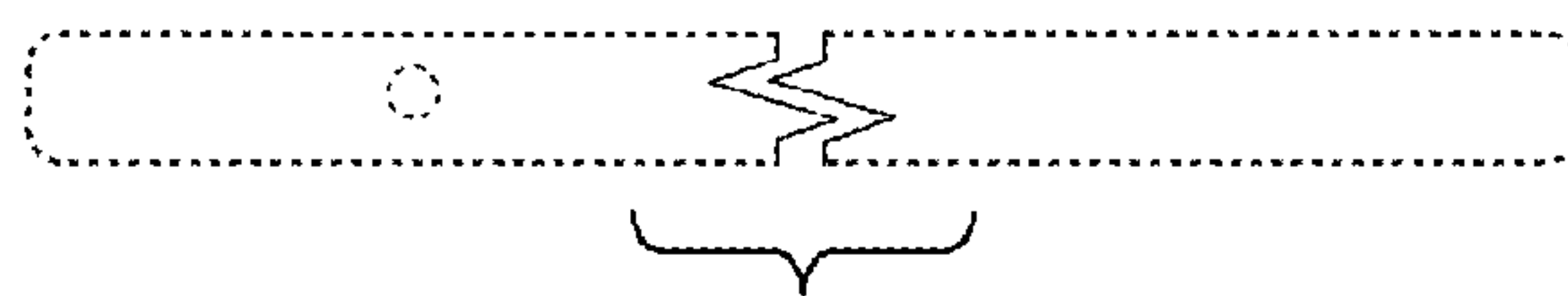

FIG. 33

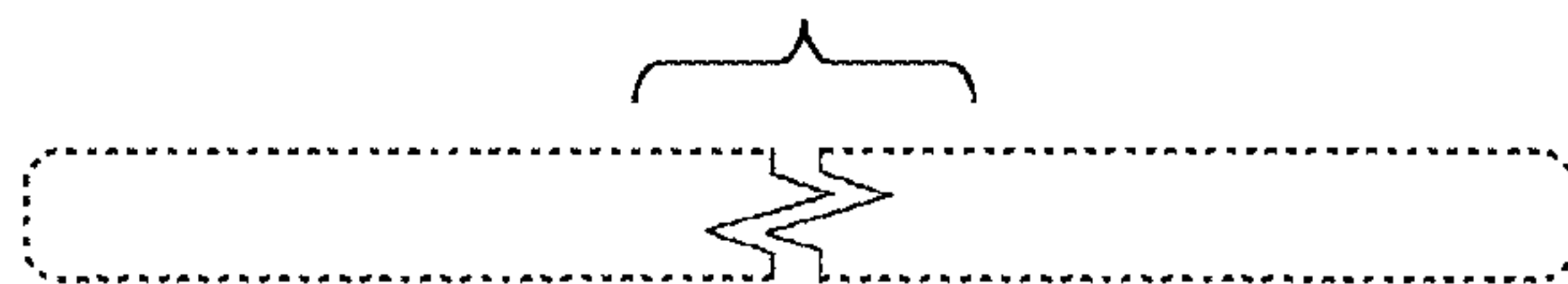

FIG. 34

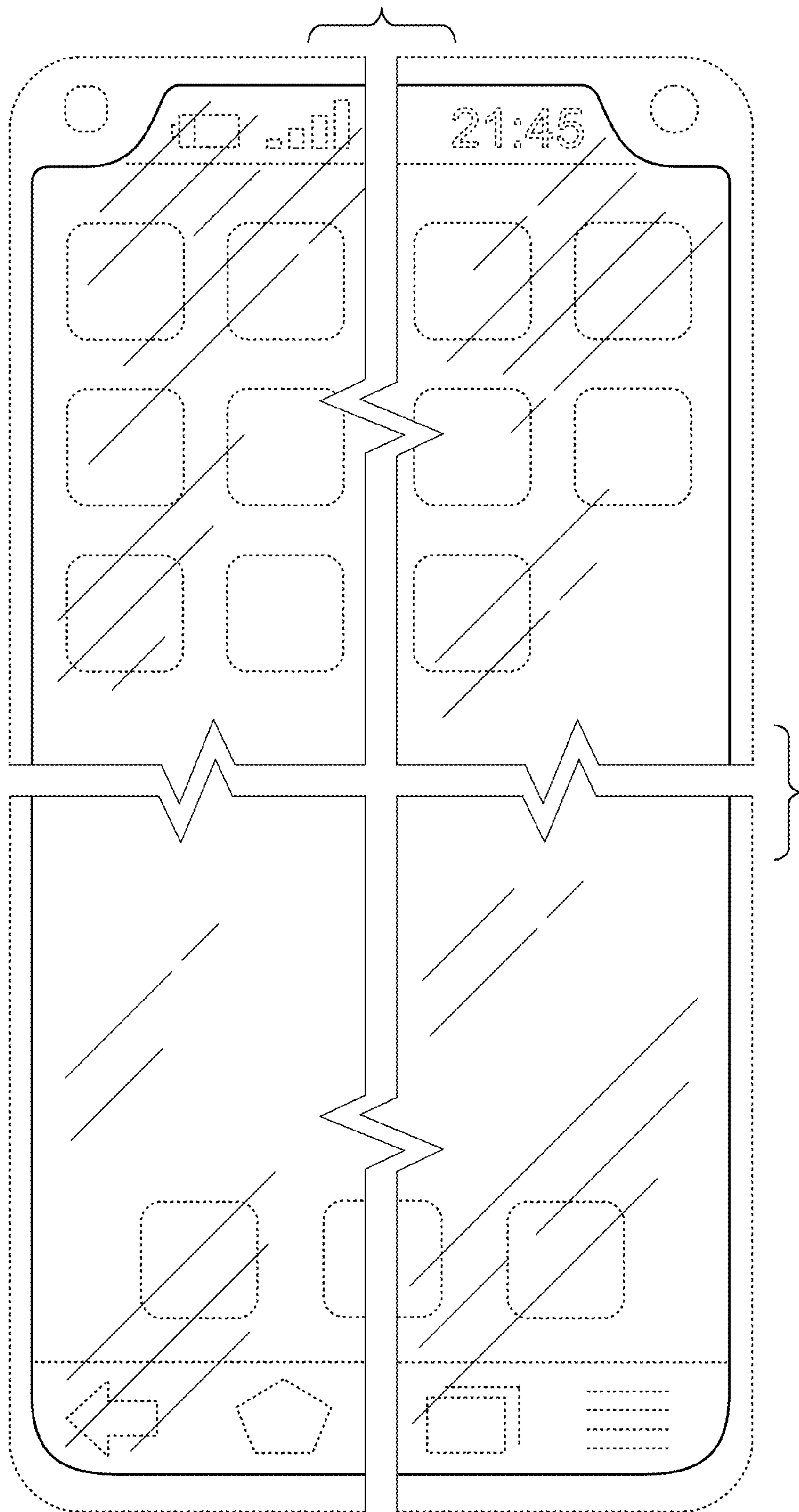

FIG. 35

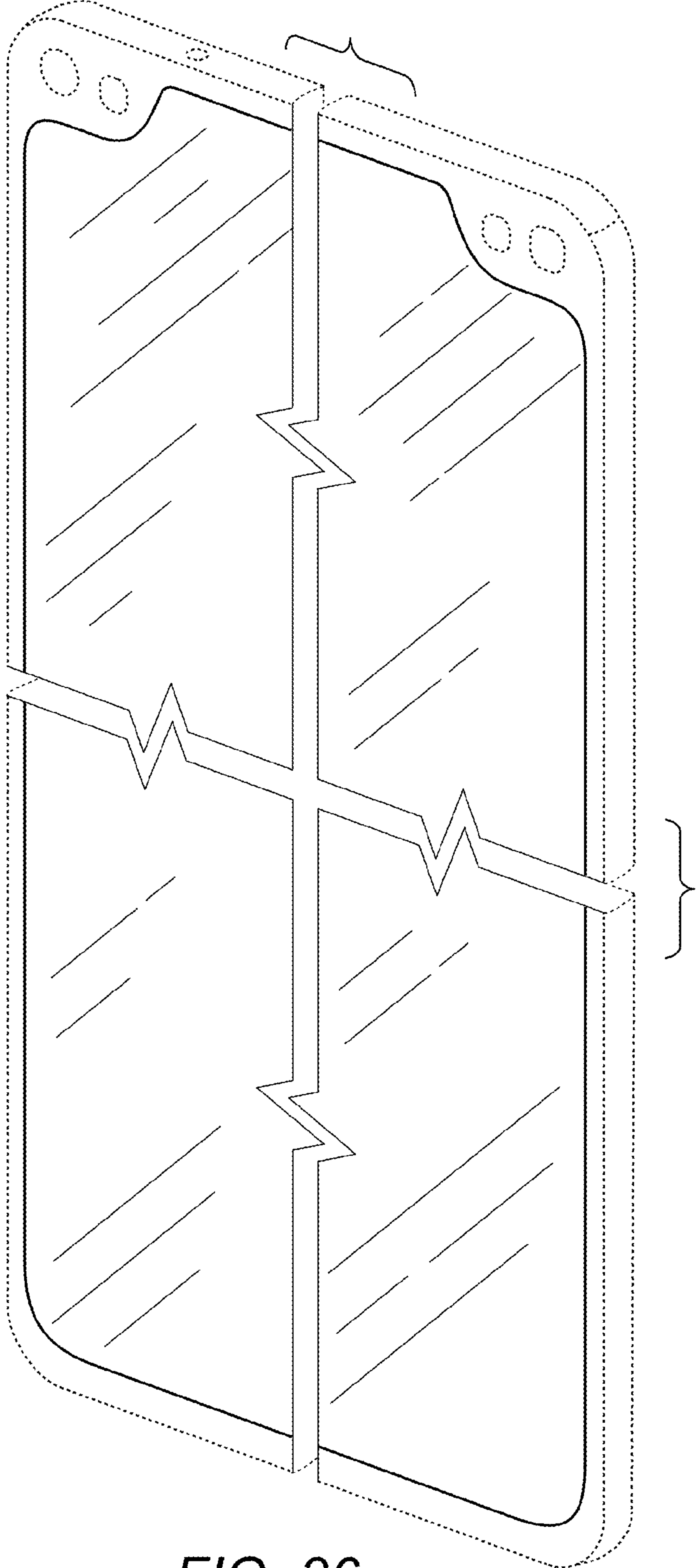

FIG. 36

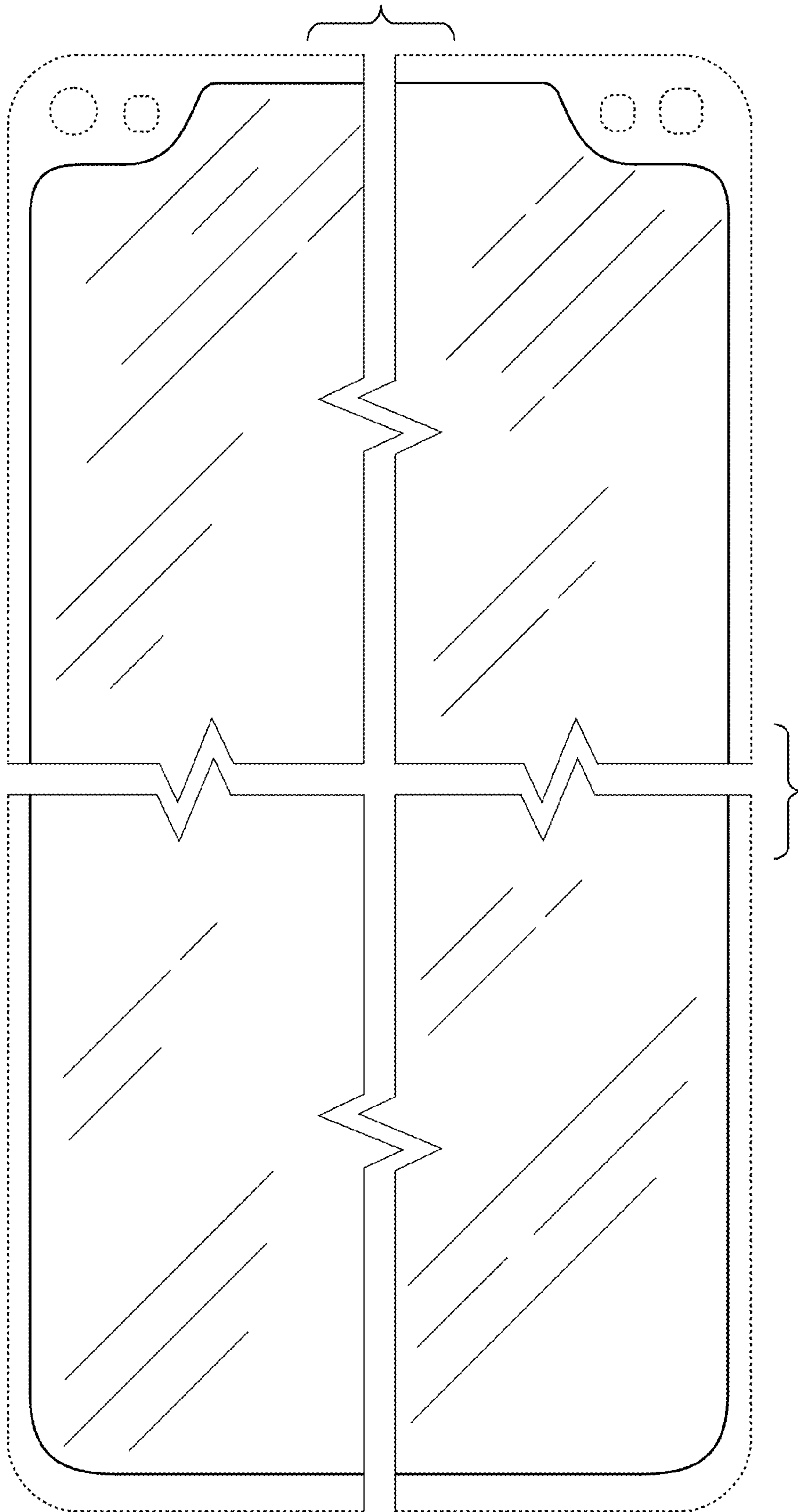

FIG. 37

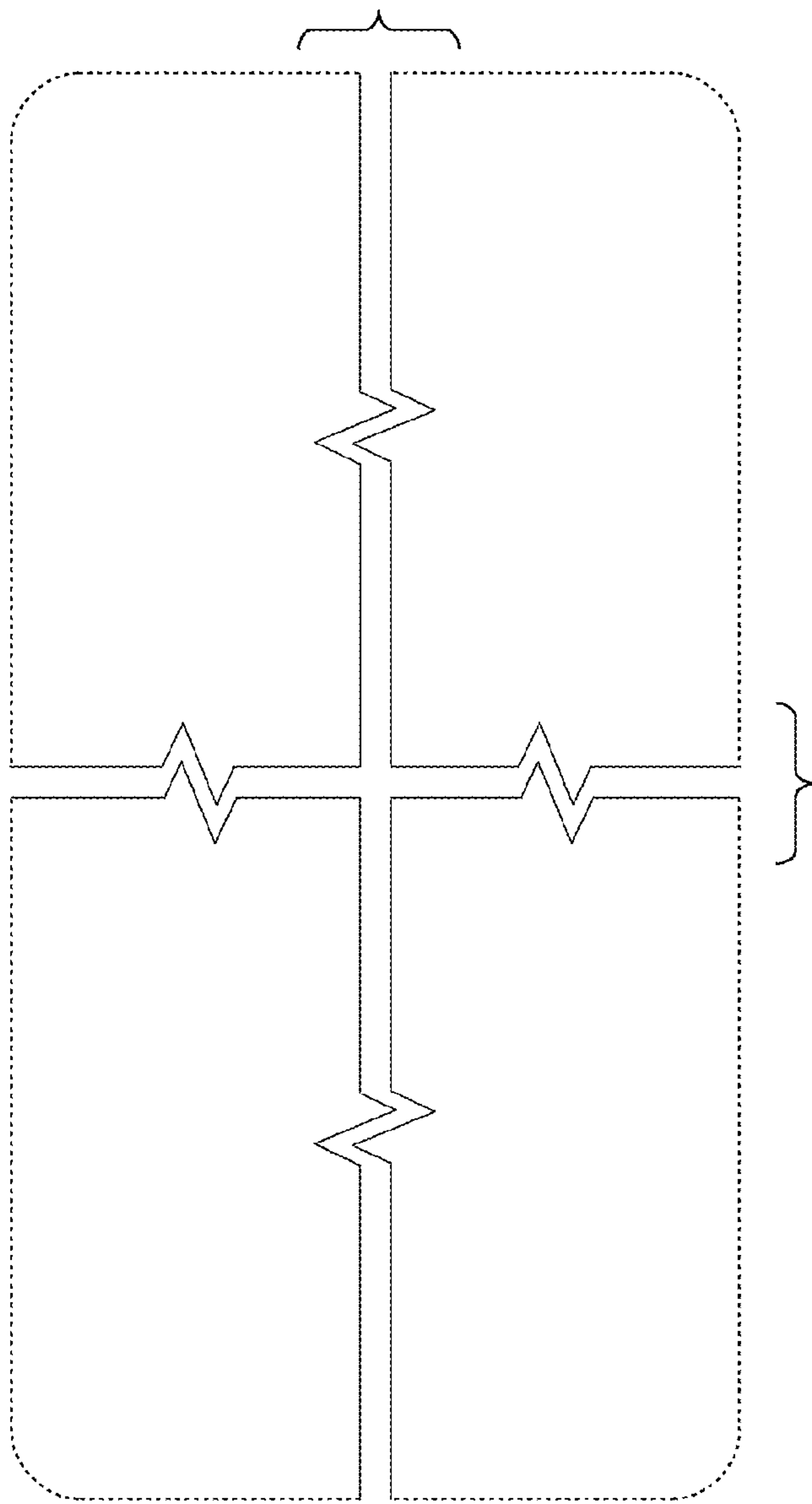

FIG. 38

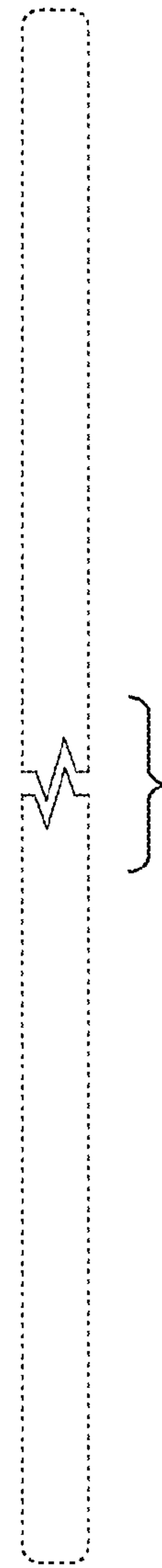

FIG. 39

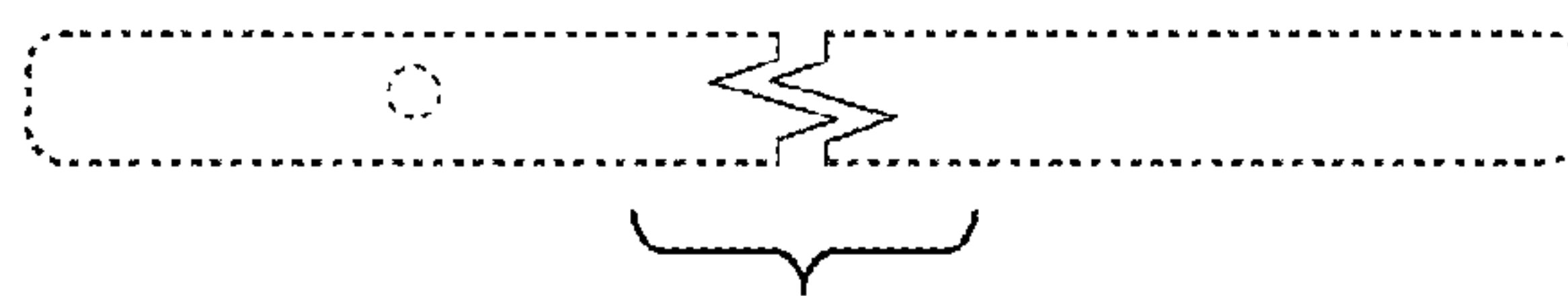

FIG. 40

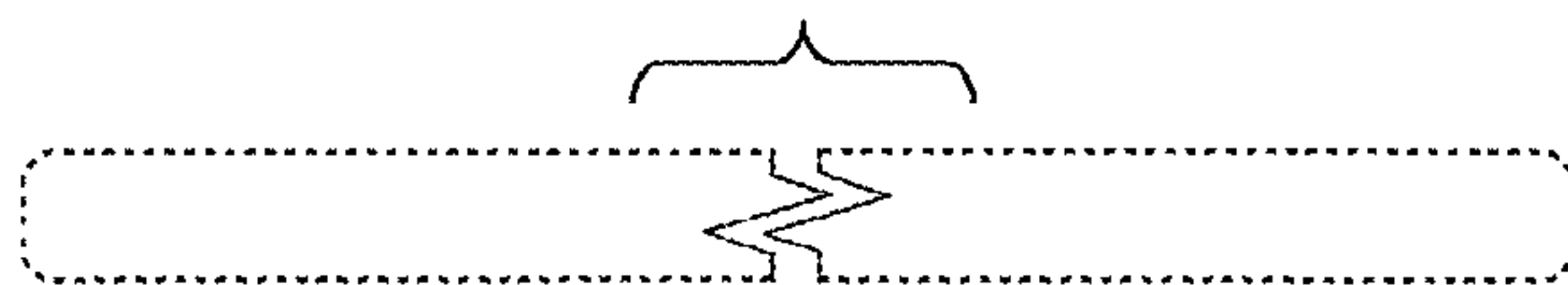

FIG. 41

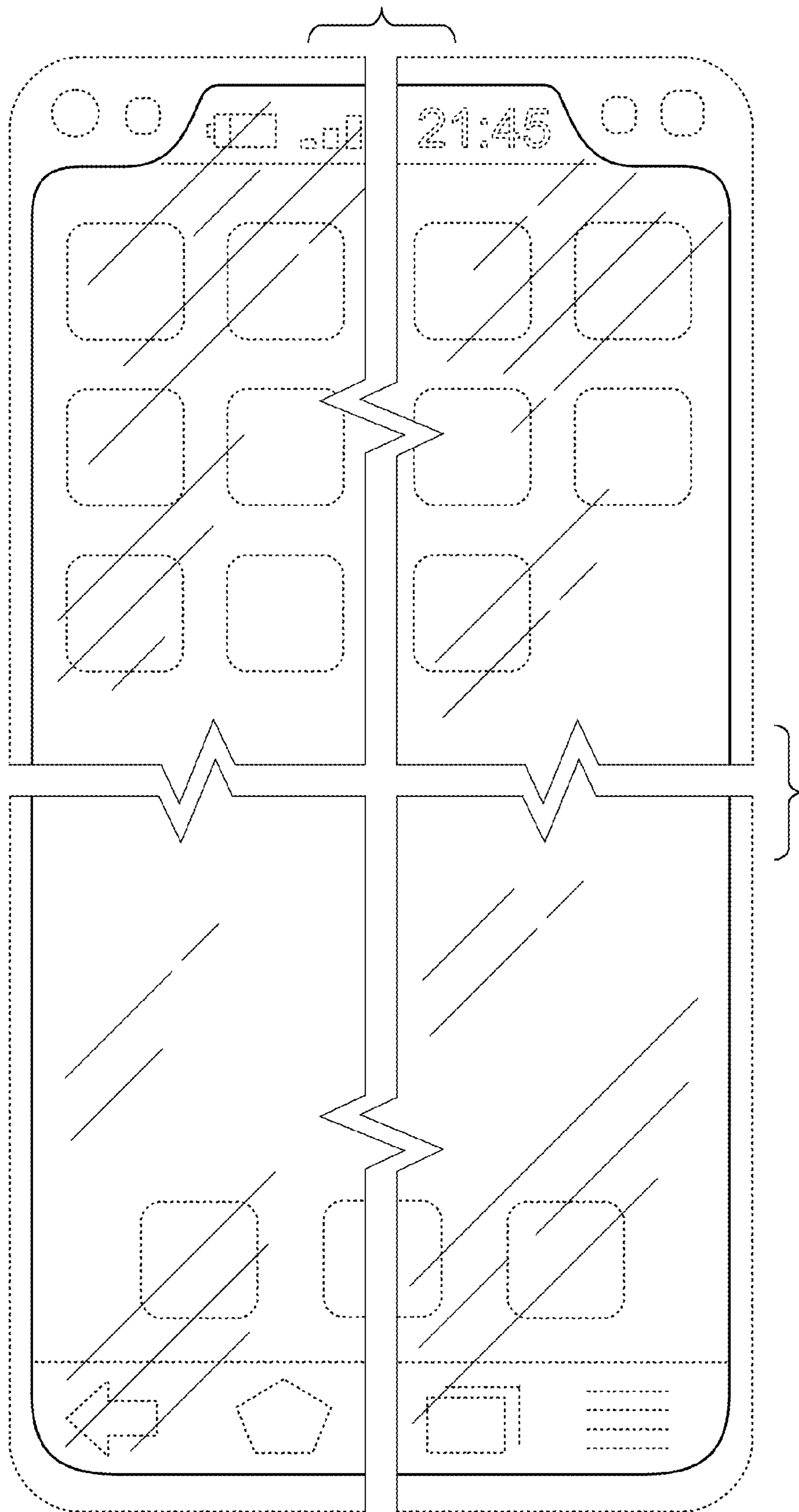

FIG. 42