



US00D913197S

(12) **United States Design Patent** (10) **Patent No.:** **US D913,197 S**
Badillo (45) **Date of Patent:** **** Mar. 16, 2021**

- (54) **RACK FOR A VEHICLE**
- (71) Applicant: **Paul Badillo**, Littleton, CO (US)
- (72) Inventor: **Paul Badillo**, Littleton, CO (US)
- (73) Assignee: **INTELLIGENT DESIGNS 2000 CORP.**, Aurora, CO (US)
- (**) Term: **15 Years**
- (21) Appl. No.: **29/640,814**
- (22) Filed: **Mar. 16, 2018**
- (51) **LOC (13) Cl.** **12-16**
- (52) **U.S. Cl.**
 USPC **D12/412**
- (58) **Field of Classification Search**
 USPC D12/412, 406, 413, 414, 414.1; D6/552;
 D3/304-306
 CPC B60R 9/04; B60R 9/048; B60R 9/045
 See application file for complete search history.

- | | | |
|-------------|---------|-------------------|
| 3,330,454 A | 7/1967 | Boll |
| 3,531,006 A | 9/1970 | Farchmin |
| D223,753 S | 6/1972 | Seals |
| 3,762,587 A | 10/1973 | Longee, Sr. |
| 3,765,713 A | 10/1973 | Suitt |
| 3,902,642 A | 9/1975 | McNeece |
| 3,905,499 A | 9/1975 | Speidel |
| 3,915,323 A | 10/1975 | Underhill |
| D243,447 S | 2/1977 | Smith, III et al. |
| 4,240,571 A | 12/1980 | Ernst |
| 4,249,683 A | 2/1981 | Park |
- (Continued)

- (56) **References Cited**
- U.S. PATENT DOCUMENTS
- | | | |
|-------------|---------|------------------|
| D30,369 S | 3/1899 | Mandt |
| D33,754 S | 12/1900 | Hien |
| 704,436 A | 7/1902 | Cluff |
| 744,113 A | 11/1903 | Rye |
| 1,564,776 A | 12/1925 | Green |
| 1,606,954 A | 11/1926 | Moen et al. |
| 2,387,779 A | 10/1945 | Strauss |
| 2,492,841 A | 12/1949 | Burkey |
| 2,521,815 A | 9/1950 | Will |
| 2,663,472 A | 12/1953 | Belgau |
| 2,784,888 A | 3/1957 | Lecanu-Deschamps |
| 2,800,264 A | 7/1957 | McFadyen |
| 2,967,635 A | 1/1961 | Barnett |
| 3,158,301 A | 11/1964 | Hedgepeth |
| 3,215,323 A | 11/1965 | Bonitt |
| 3,260,929 A | 7/1966 | Hedgepeth |

OTHER PUBLICATIONS

Official Action for U.S. Appl. No. 29/535,865, dated Jun. 28, 2018, 9 pages.

(Continued)

Primary Examiner — Katrina A Betton
(74) Attorney, Agent, or Firm — Sheridan Ross P.C.

(57) **CLAIM**

The ornamental design for a rack for a vehicle, as shown and described.

DESCRIPTION

FIG. 1 is a front perspective view of the rack for a vehicle; FIG. 2 is a front elevation view thereof; FIG. 3 is a rear elevation view thereof; FIG. 4 is a right elevation view thereof; FIG. 5 is a left elevation view thereof; FIG. 6 is a top plan view thereof; FIG. 7 is a bottom plan view thereof; and, FIG. 8 is a perspective view of the rack for a vehicle of the embodiment of FIG. 1 provided in combination with a vehicle.

The broken lines are included for the purpose of illustrating environment and form no part of the claimed design.

1 Claim, 8 Drawing Sheets

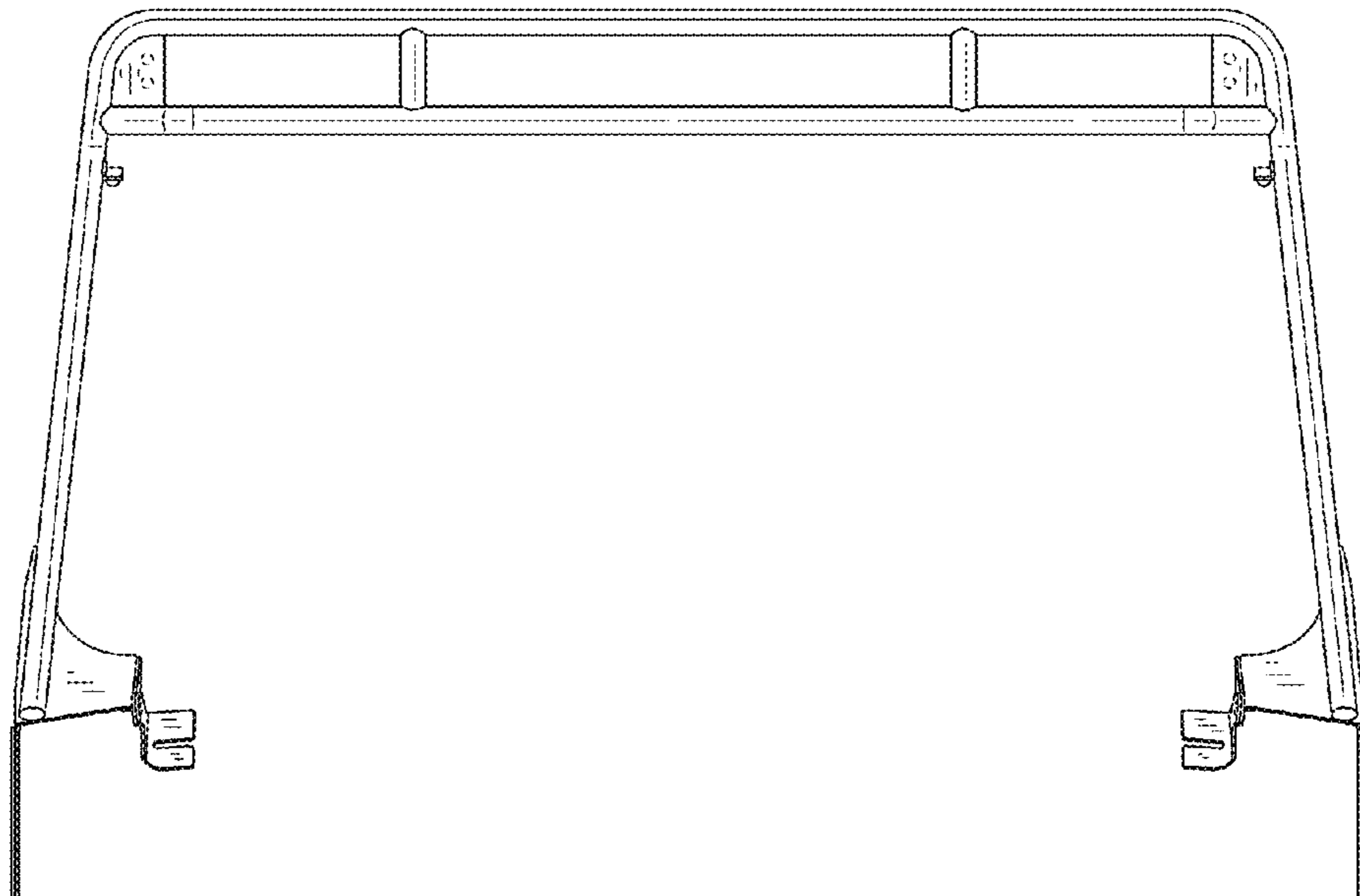

(56)

References Cited

U.S. PATENT DOCUMENTS

4,336,897 A 6/1982 Luck
 4,350,471 A 9/1982 Lehman
 4,538,752 A 9/1985 Welter
 D294,137 S 2/1988 Robson
 D299,224 S 1/1989 Kamaya
 D299,913 S * 2/1989 Arvidsson D12/414
 4,817,834 A 4/1989 Weiler
 D306,990 S 4/1990 Bott
 4,948,024 A 8/1990 Warner et al.
 4,995,538 A 2/1991 Marengo
 D324,664 S 3/1992 Burnette
 5,171,083 A 12/1992 Rich
 D340,690 S 10/1993 Arvidsson
 D344,482 S 2/1994 Arvidsson
 5,320,061 A 6/1994 Laughlin et al.
 5,381,939 A 1/1995 Tippets
 D359,134 S 6/1995 Toews
 5,492,259 A 2/1996 Tippets
 5,560,525 A 10/1996 Grohmann et al.
 D406,557 S 3/1999 Bentley
 D413,562 S 9/1999 Van Dusen et al.
 D415,718 S 10/1999 Aghaci
 6,003,633 A 12/1999 Rolson
 6,015,074 A 1/2000 Snavely et al.
 D422,553 S 4/2000 VonDuyke
 6,116,378 A 9/2000 Barrow
 6,126,051 A 10/2000 Potter
 D434,364 S 11/2000 Bauer et al.
 6,152,339 A 11/2000 Kreisler
 D434,718 S 12/2000 Kreisler
 D435,510 S 12/2000 Quidort
 6,179,180 B1 1/2001 Walker et al.
 D442,289 S 5/2001 Ziaylek et al.
 D448,717 S 10/2001 Hanson et al.
 D449,029 S 10/2001 Hanson et al.
 6,308,874 B1 10/2001 Kim et al.
 6,425,508 B1 7/2002 Cole et al.
 6,428,263 B1 8/2002 Schellens
 D463,358 S 9/2002 Thomas
 D470,451 S 2/2003 Bushart et al.
 6,561,397 B1 5/2003 Bauer et al.
 6,581,813 B2 6/2003 Bove et al.
 D477,562 S 7/2003 McCoy et al.
 6,604,606 B1 8/2003 McDougal et al.
 D479,884 S 9/2003 Berryman
 D481,003 S 10/2003 Bauer et al.
 6,715,652 B2 4/2004 Krnita et al.
 D490,163 S 5/2004 Thurston
 6,739,349 B2 5/2004 Kastenschmid et al.
 6,755,332 B2 6/2004 Crane et al.
 6,772,928 B2 8/2004 Ford et al.
 D508,015 S 8/2005 Badillo
 D512,783 S 12/2005 Badillo
 D520,938 S 5/2006 Badillo
 D521,486 S * 5/2006 Yokoyama D13/144
 7,055,454 B1 6/2006 Whiting et al.
 D537,404 S 2/2007 Bauer et al.
 7,226,226 B2 6/2007 Troman
 7,226,266 B2 6/2007 Henderson et al.
 7,249,927 B2 7/2007 Wooten et al.
 D549,838 S 8/2007 Badillo
 D558,123 S 12/2007 Murillo
 D564,419 S 3/2008 Clontz
 D578,952 S 10/2008 Badillo
 D597,924 S * 8/2009 Smith D12/406
 D603,321 S 11/2009 Kramer
 D604,687 S * 11/2009 Malik D12/414
 D621,328 S 8/2010 Sistare et al.
 D624,005 S 9/2010 Winner et al.
 D638,333 S 5/2011 Freeman
 D650,316 S 12/2011 Pirolo et al.
 8,496,146 B2 7/2013 Badillo
 8,591,164 B2 11/2013 Prosser
 D702,620 S * 4/2014 Read D12/223
 D717,631 S * 11/2014 Elbl D6/550

D758,256 S * 6/2016 Cropley D12/412
 D765,577 S 9/2016 Kmita et al.
 D772,783 S 11/2016 Schleef
 D777,080 S 1/2017 Cropley et al.
 9,676,343 B2 6/2017 Badillo
 D793,946 S 8/2017 Badillo
 D815,012 S 4/2018 Badillo
 D825,924 S 8/2018 Tuang
 D831,562 S * 10/2018 Salsi D12/412
 D867,262 S 11/2019 Eriksson et al.
 D879,703 S * 3/2020 Perry D12/412
 D881,792 S * 4/2020 Tang D12/412
 2005/0082326 A1 4/2005 Badillo
 2005/0092796 A1 5/2005 Essig
 2005/0095102 A1 5/2005 Watson
 2011/0101056 A1 5/2011 Barkey
 2017/0203697 A1 7/2017 Badillo
 2018/0319270 A1 11/2018 Tier et al.

OTHER PUBLICATIONS

Official Action for U.S. Appl. No. 15/586,769, dated Jun. 26, 2018, 8 pages.
 Official Action for U.S. Appl. No. 15/344,244, dated Jun. 21, 2018, 11 pages.
 Official Action for U.S. Appl. No. 16/516,530, dated Feb. 3, 2020 9 pages.
 U.S. Appl. No. 29/535,865, filed Aug. 11, 2015, Badillo.
 U.S. Appl. No. 15/586,769, filed May 4, 2017, Badillo.
 U.S. Appl. No. 29/612,924, filed Aug. 4, 2017, Badillo.
 U.S. Appl. No. 29/612,927, filed Aug. 4, 2017, Badillo.
 U.S. Appl. No. 29/612,929, filed Aug. 17, 2017, Badillo.
 U.S. Appl. No. 29/612,930, filed Aug. 17, 2017, Badillo.
 Advertisement: Yakima Spare Tire Carrier, Cargo Basket for Roof Racks, available at http://www.rackoutfitters.com/catalog/yakima_spare_tire_carrier_1836640.htm, dated Jul. 7, 2003, 1 page.
 Advertisement: Thule 840—Playpen Basket, Cargo Basket for Roof Racks, available at http://www.rackoutfitters.com/catalog/thule_840_-_playpen_basket_1885452.htm, dated Jul. 7, 2003, 1 page.
 Advertisement: SURCO, Products, Inc., “Basket rack-it just flat out carries what you need to take,” available at http://www.everythingsuv.com/surco_safari_roofracks-esuv.asp, dated Jul. 7, 2003, 10 pages.
 Advertisement: KargoMaster, Kargo Master Safari Racks, available at http://www.kargomaster.com/jeep23.asp?rack=sport_jeep, Jul. 7, 2007, 1 page.
 Advertisement: KargoMaster, The Bushman Steel Rack, available at <http://www.kargomaster.com/bushman.asp?type=Jeep>, dated Jul. 7, 2003, 1 page.
 Advertisement: KargoMaster, Seregenti Telescoping Steel Rack, available at <http://www.kargomaster.com/seregenti.asp?type=Jeep>, dated Jul. 7, 2003, 1 page.
 Advertisement: Bauer Vehicle Gear Roof Racks, Roof Storage, Bike Storage & Pet Barriers from Eve, available at http://www.everythingsuv.com/bvg_products-esuv.asp, Jul. 7, 2003, 2 pages.
 Advertisement: Manik Original Off-Road Equipment, Hummer Rough Terrain Package New Product Release “Tilt-Forward 1-Piece Front Bar,” 2002, 1 page.
 Advertisement: Manik Original Off-Road Equipment, Hummer Rough Terrain Package New Product Release “Combination Tube Step Rocker Bar,” 2002, 1 page.
 Advertisement: Congo Cage Jeep Rack, available at <http://www.kargomaster.com/item.asp?d=62>, printed Apr. 17, 2009, 13 pages.
 Product Literature entitled, “921-Dave’s Rack 921-12X,” Olympic 4x4, date unknown, 10 pages.
 Advertisement: 921—Chaves Rack, Olympic 4x4 Products for over 60 years, available at <http://olympic4X4products.com/utility-racks/921-daves-rack>, printed Jan. 14, 2011, 3 pages.
 “Installation Guide: BR-JPTJ2D-1-0 BajaRack Jeep TJ 2 Doors,” BajaRack Adventure Equipment, 4 page, first sold 2013.
 “BR-JPJK-Series Installation Instructions,” BajaRack Adventure Equipment, 5 pages, first sold 2013.
 “Installation Guide: BR-JP-JK4D-1-0 BajaRack Jeep JK 4 Doors,” BajaRack Adventure Equipment, 6 pages, first sold 2013.

(56)

References Cited

OTHER PUBLICATIONS

Official Action for U.S. Appl. No. 12/861,034 dated Oct. 4, 2012, 16 pages.
Notice of Allowance for U.S. Appl. No. 12/861,034 dated Mar. 29, 2013, 7 pages.
Official Action for U.S. Appl. No. 13/942,489 dated May 3, 2016, 11 pages.
Final Action for U.S. Appl. No. 13/942,489 dated Sep. 29, 2016, 15 pages.
Notice of Allowance for U.S. Appl. No. 13/942,489 dated Feb. 7, 2017, 5 pages.
Official Action for U.S. Appl. No. 29/535,865 dated Aug. 23, 2016, 5 pages.
Final Action for U.S. Appl. No. 29/535,865 dated Feb. 2, 2017, 8 pages.
Notice of Allowance for U.S. Appl. No. 29/535,957 dated Mar. 27, 2017, 6 pages.
Official Action for U.S. Appl. No. 15/586,769 dated Jul. 17, 2017 14 pages.
Official Action for U.S. Appl. No. 29/535,865, dated Nov. 3, 2017 10 pages.
Official Action for U.S. Appl. No. 15/586,769, dated Dec. 5, 2017 9 pages.
Notice of Allowance for U.S. Appl. No. 29/612,929 dated Sep. 27, 2018, 7 pages.
Notice of Allowance for U.S. Appl. No. 29/612,927 dated Sep. 27, 2018, 7 pages.

Notice of Allowance for U.S. Appl. No. 29/612,924 dated Sep. 27, 2018, 7 pages.
Notice of Allowance for U.S. Appl. No. 29/612,930, dated Sep. 27, 2018, 7 pages.
Official Action for U.S. Appl. No. 16/516,530, dated Jul. 29, 2020 11 pages.
Notice of Allowance for U.S. Appl. No. 16/355,179, dated Jun. 16, 2020 8 pages.
U.S. Appl. No. 16/355,179, filed Mar. 15, 2019, Badillo.
U.S. Appl. No. 29/686,324, filed Apr. 3, 2019, Badillo.
“GOBI Jeep JL 4 Door Roof Rack Gen 1 Installation Instructions,” Intelligent Designs 2000 Corporation, Aug. 29, 2018, Part No. GJJLRG1, 26 pages. [retrieved online from: www.gobiracks.com/wp-content/uploads/2019/01/JEEP-JL-Rack-Install-Guide.pdf].
Notice of Allowance for U.S. Appl. No. 29/535,865, dated Jan. 14, 2019, 8 pages.
Notice of Allowance for U.S. Appl. No. 15/586,769, dated Jan. 28, 2019, 5 pages.
Notice of Allowance for U.S. Appl. No. 15/344,244, dated Feb. 21, 2019, 14 pages.
“Yakima, RoundBar SL Adapter to Attach Streamline Towers to RoundBar Crossbars,” Amazon.com, Inc., First Available Aug. 20, 2009, 8 pages [retrieved online from: www.amazon.com/Yakima-8003536-RoundBar-StreamLine-Adapter/dp/B0171A61KC/ref=sr_1_1?dchild=1&keywords=8003536&q id=1603147545&sr=8-1].
Official Action for U.S. Appl. No. 29/686,324, dated Oct. 26, 2020, 6 pages. Restriction Requirement.

* cited by examiner

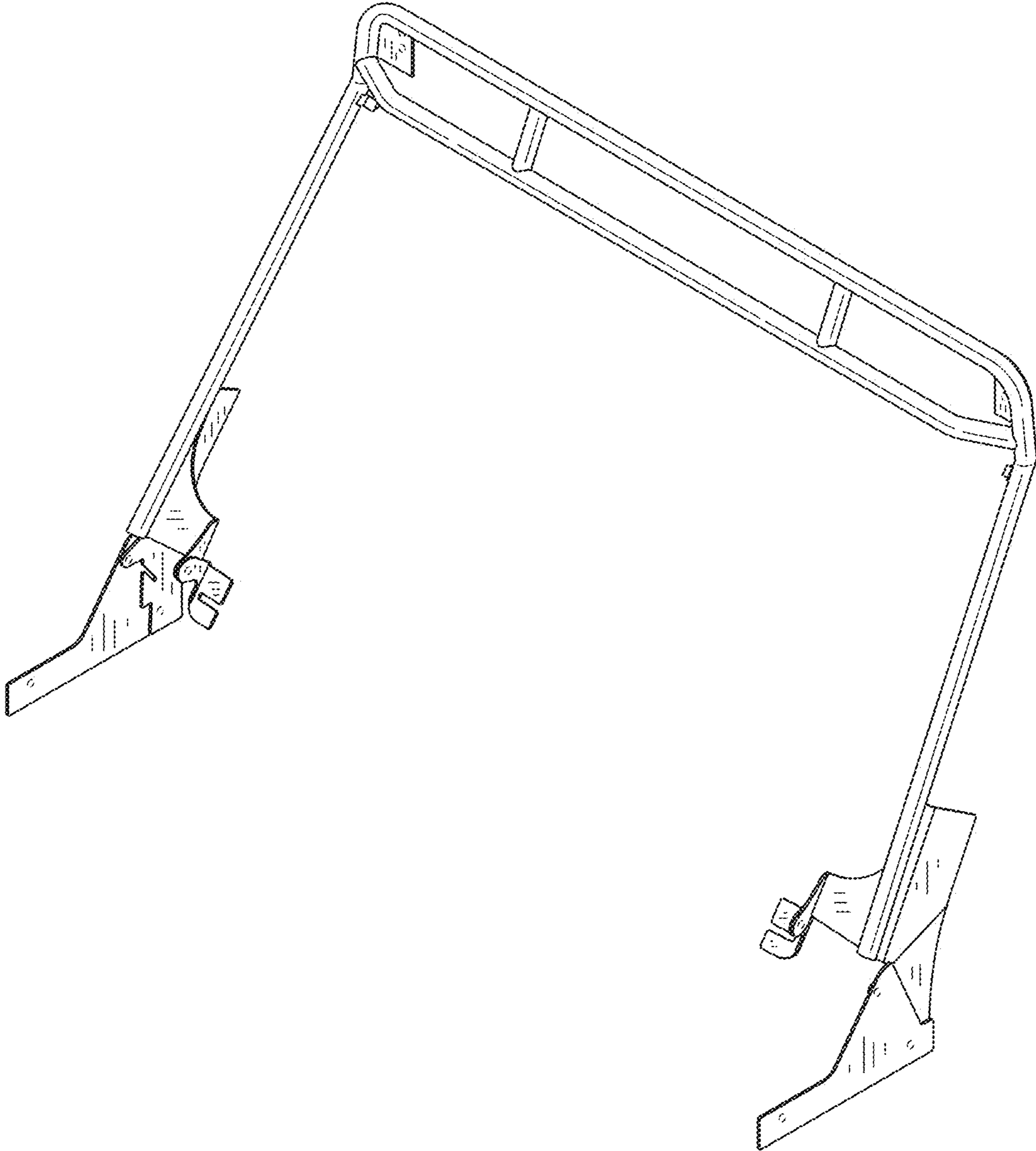

FIG. 1

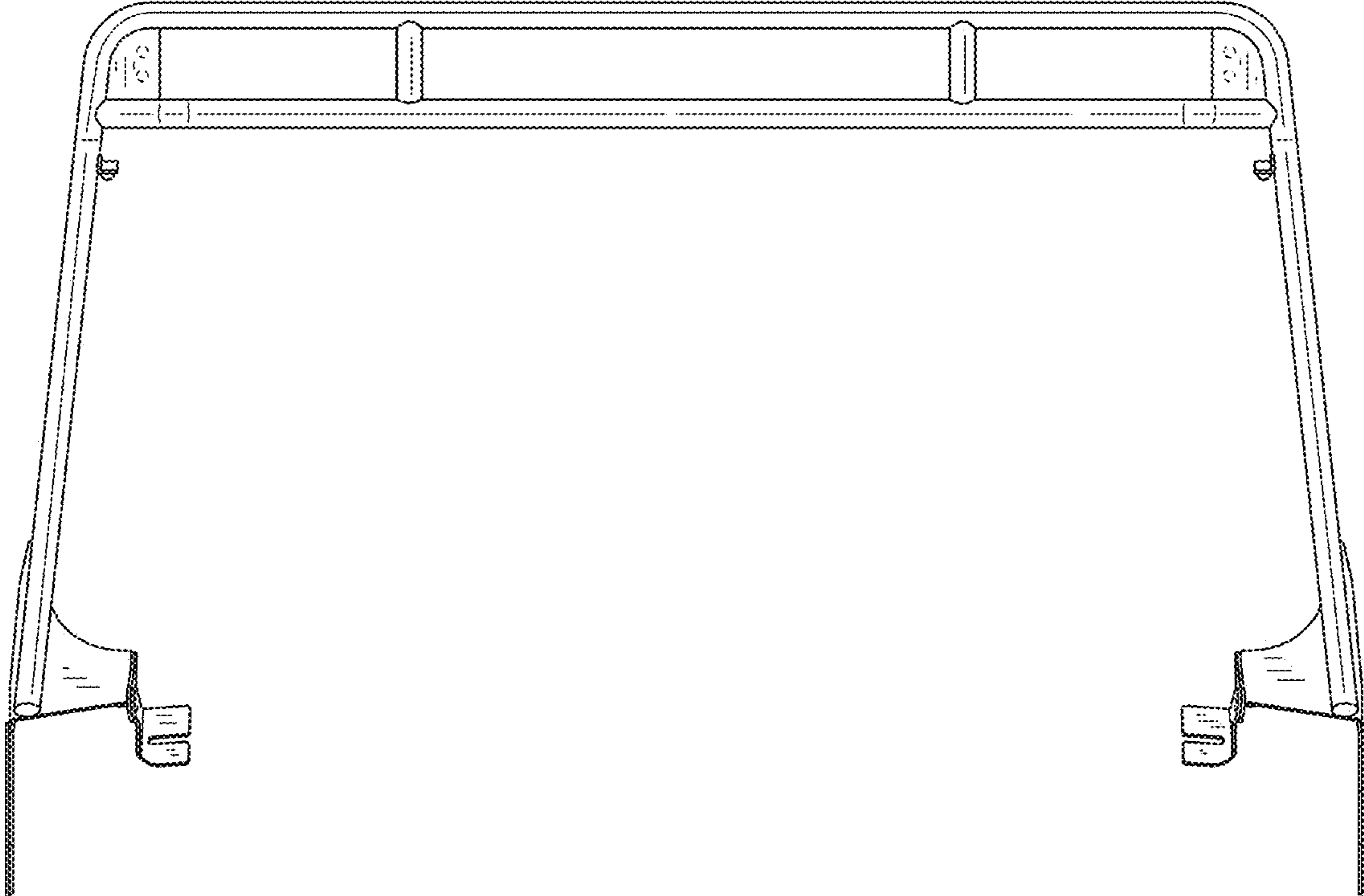

FIG.2

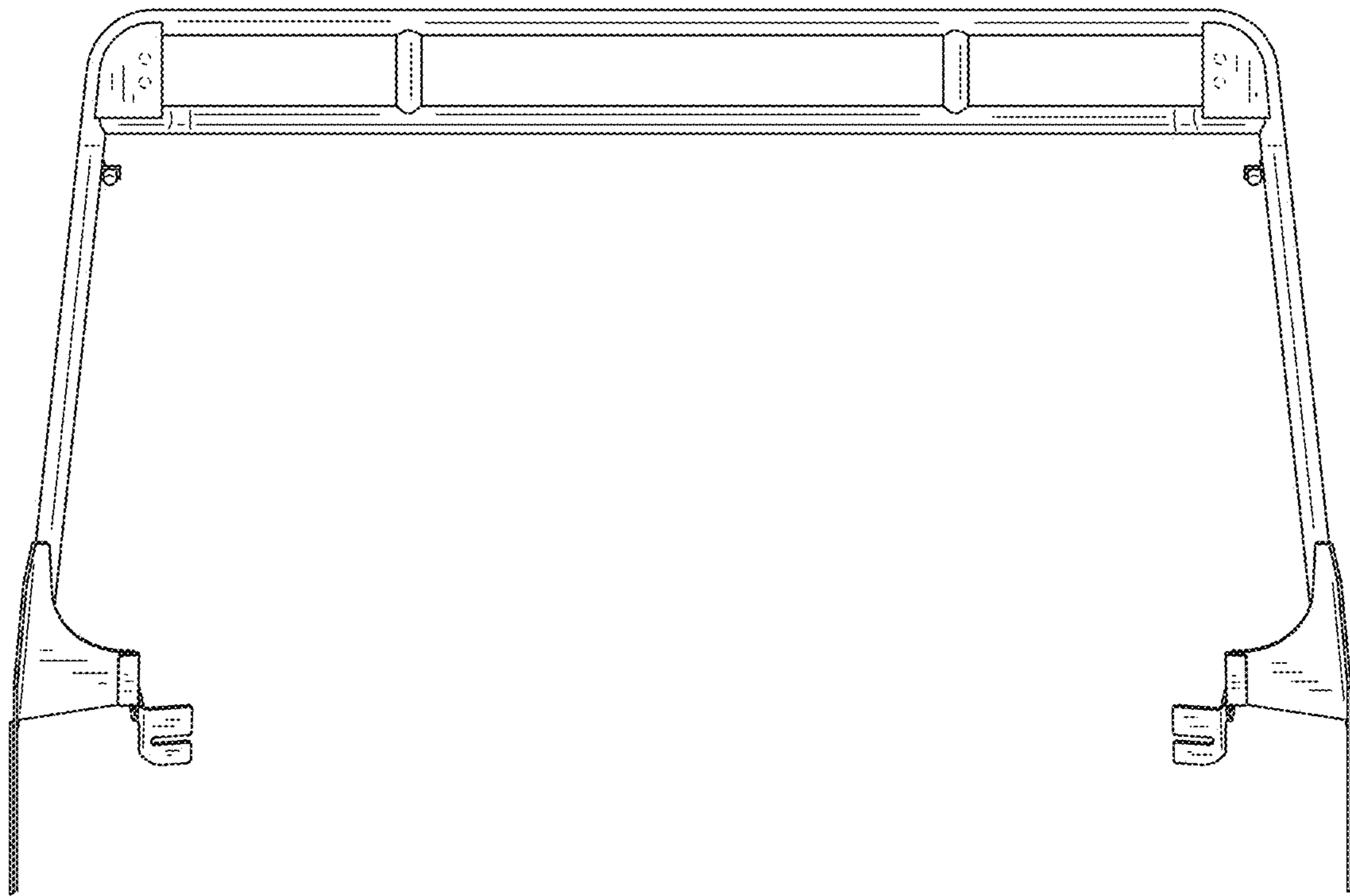

FIG.3

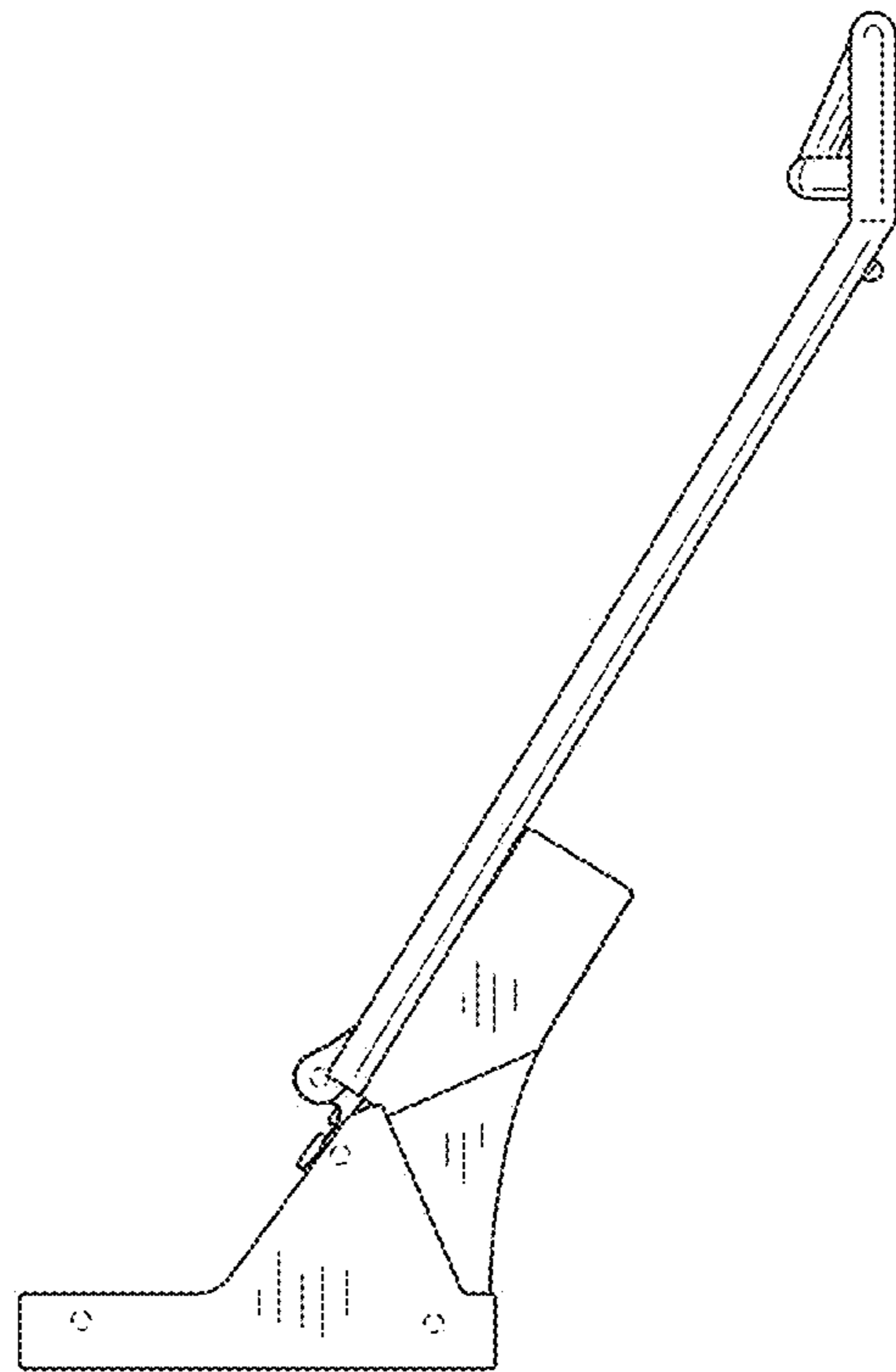

FIG.4

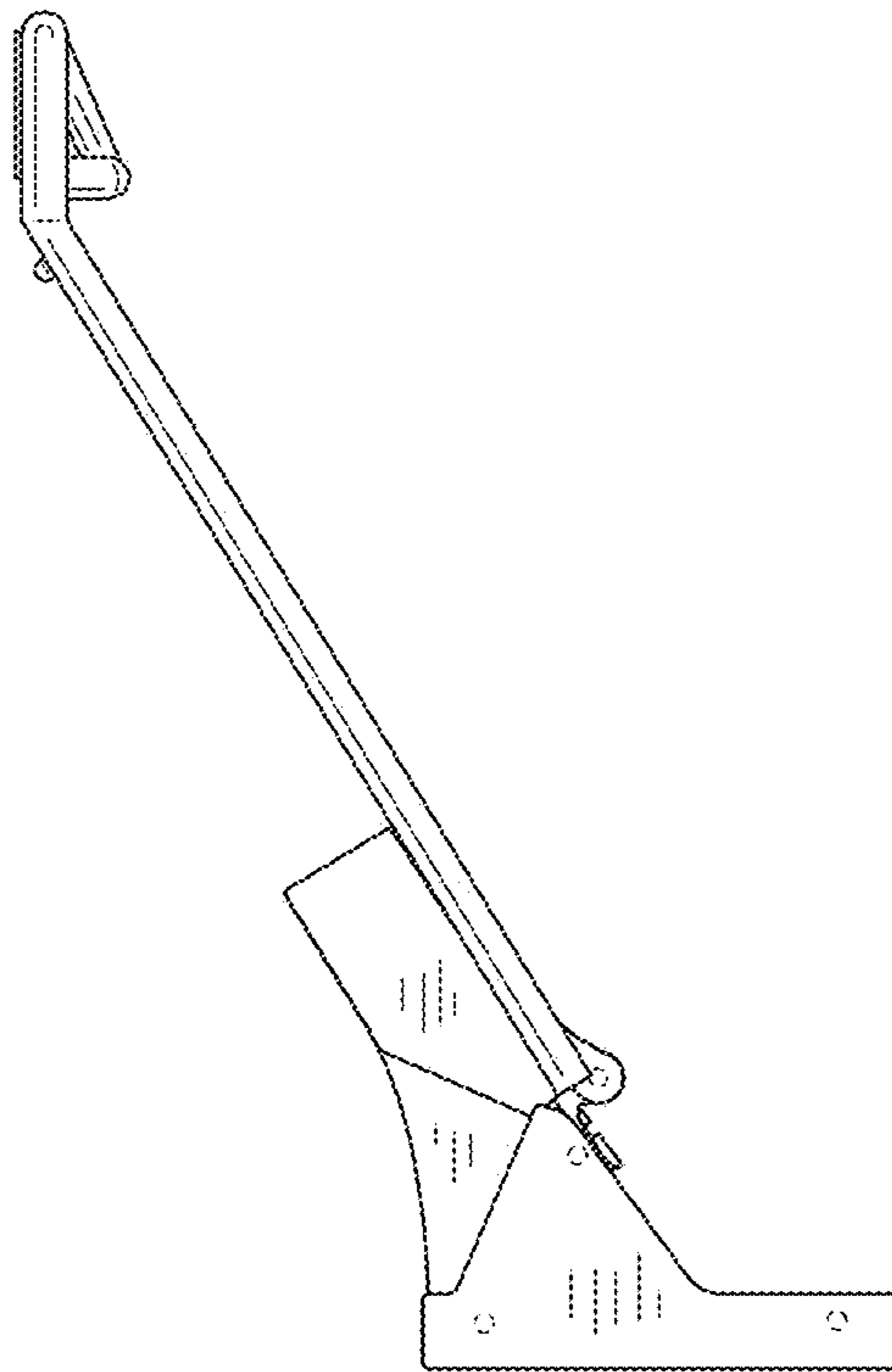

FIG.5

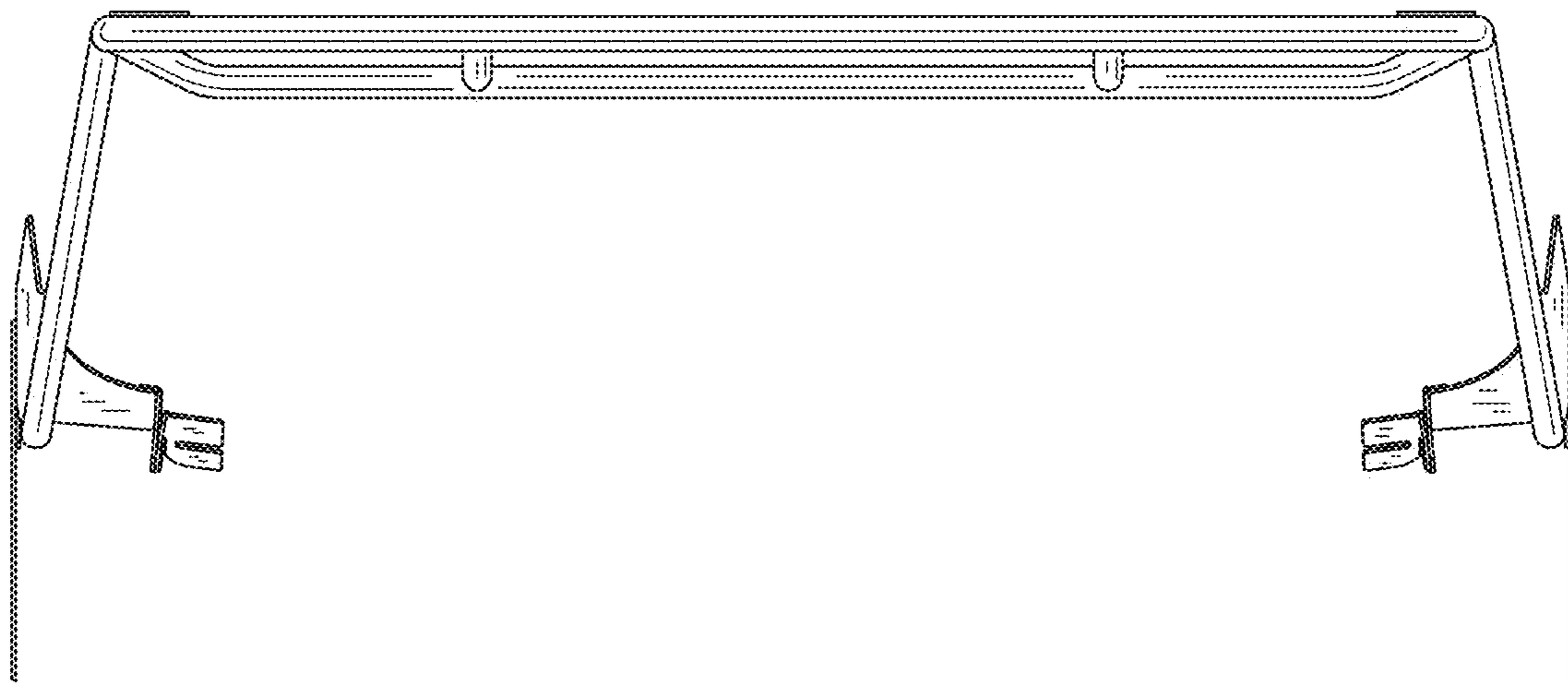

FIG.6

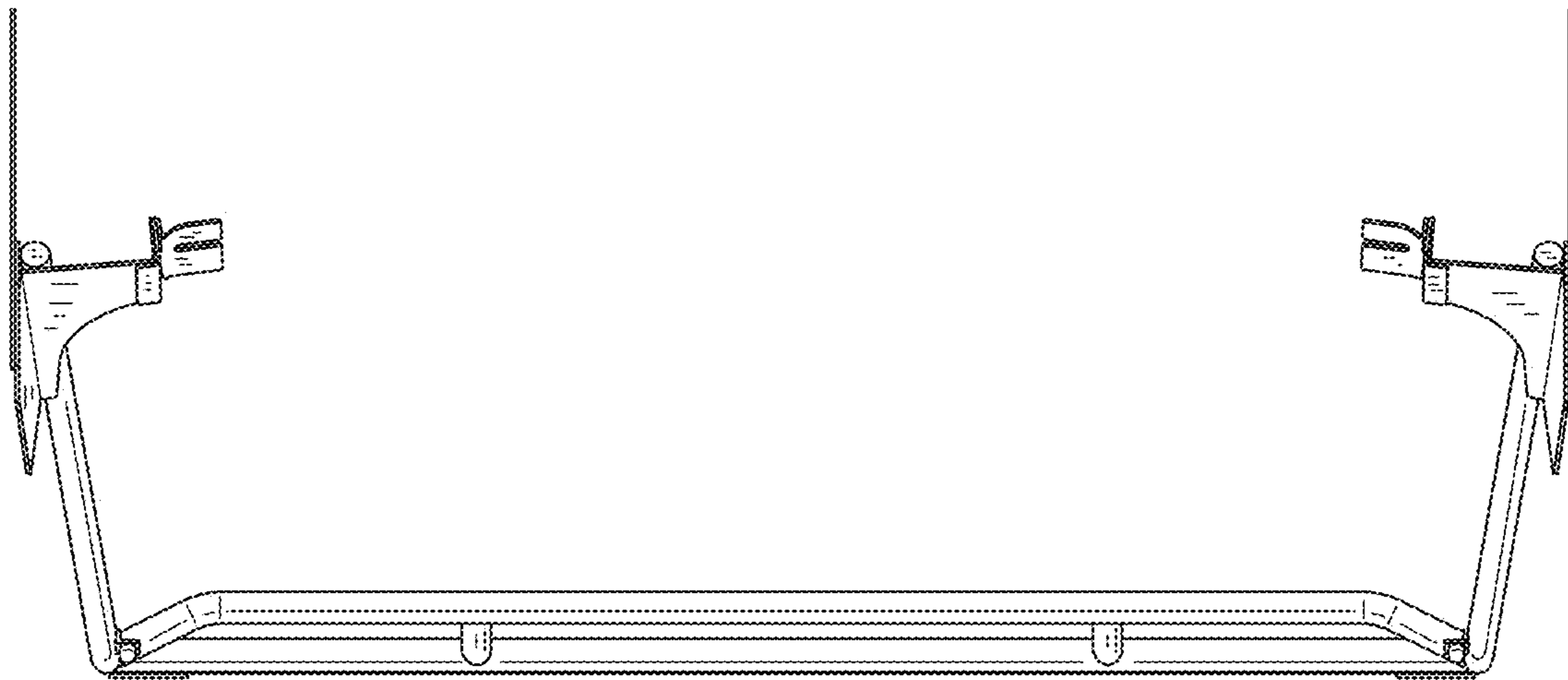

FIG.7

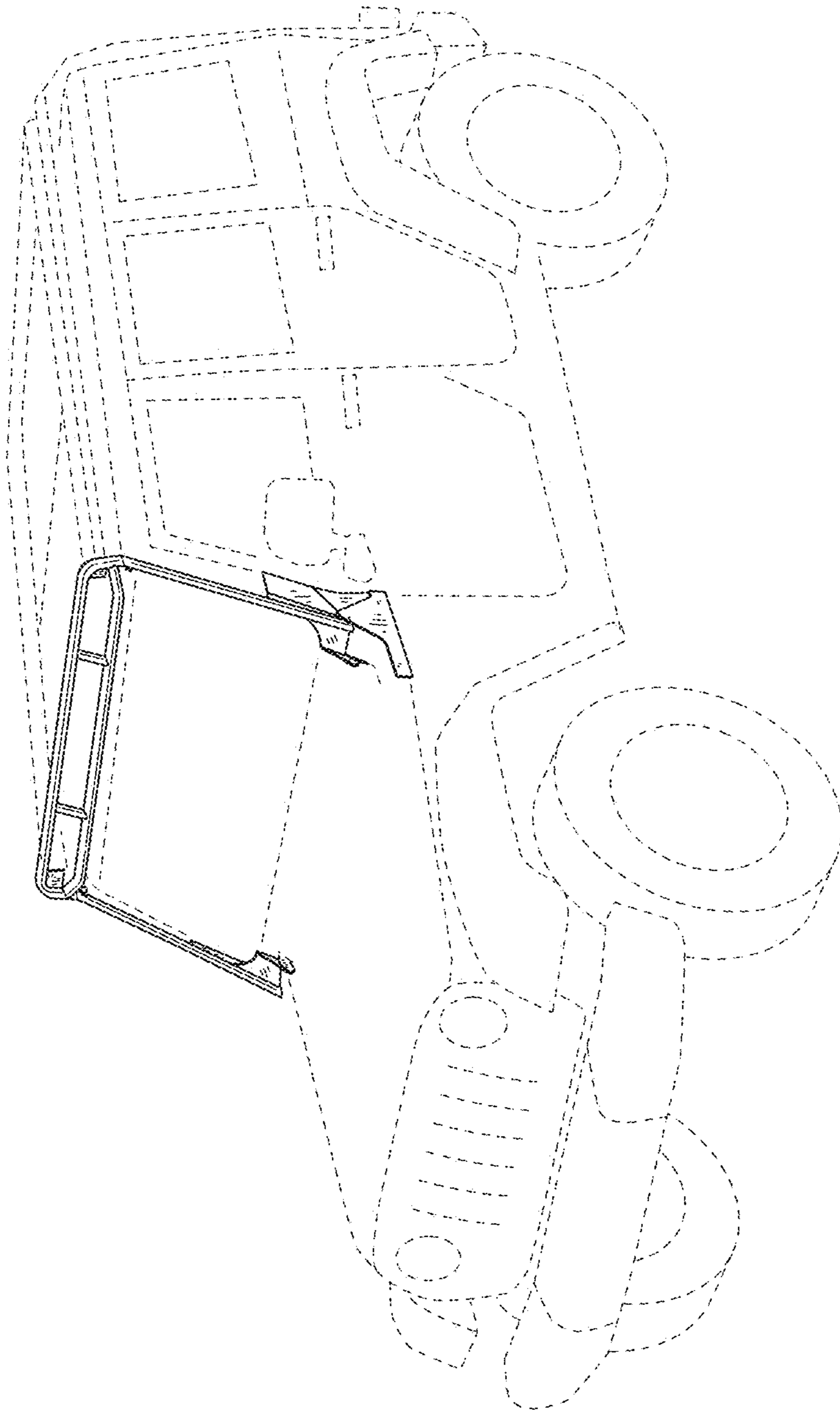

FIG. 8