



US00D913191S

(12) **United States Design Patent**  
**Builder et al.**

(10) **Patent No.: US D913,191 S**

(45) **Date of Patent: \*\* \*Mar. 16, 2021**

- (54) **FLOATING PLATFORM**
- (71) Applicant: **Nautibuoy Marine Limited**, Devon (GB)
- (72) Inventors: **Clay Livingston Builder**, Dartington (GB); **Nina Anderson**, Dartington (GB)
- (73) Assignee: **Nautibuoy Marine Limited**, Devon (GB)

- 5,870,964 A \* 2/1999 Gerber ..... B63B 5/24  
114/263
- 6,089,176 A \* 7/2000 Costello ..... B63B 35/34  
114/263
- 6,098,564 A \* 8/2000 Zeilinger ..... B63C 13/00  
114/263
- 6,102,759 A \* 8/2000 Klimenko ..... A47C 27/081  
441/129
- 6,135,045 A \* 10/2000 Staff ..... B63B 7/06  
114/266
- D482,315 S \* 11/2003 Bridge ..... D12/316

(\* ) Notice: This patent is subject to a terminal disclaimer.

(\*\*) Term: **15 Years**

(21) Appl. No.: **29/662,416**

(22) Filed: **Sep. 5, 2018**

(30) **Foreign Application Priority Data**

Mar. 5, 2018 (EM) ..... 004740025-0034

(51) **LOC (13) Cl.** ..... **12-06**

(52) **U.S. Cl.**  
USPC ..... **D12/316**

(58) **Field of Classification Search**  
USPC ..... D12/316, 317; D21/801, 803  
CPC .... B63C 1/02; B63C 1/04; B63C 7/08; B63C 7/10; B63C 2009/042; B63B 35/00; B63B 35/58; B63B 35/613; B63B 17/00; B63B 2027/145; B63B 2029/022; B63B 7/08; B63B 7/082; B63B 7/085  
See application file for complete search history.

(56) **References Cited**

**U.S. PATENT DOCUMENTS**

- 2,850,252 A \* 9/1958 Ford ..... B64F 1/36  
244/114 R
- 3,675,377 A \* 7/1972 Suter ..... E04H 15/20  
52/2.16
- 5,390,620 A \* 2/1995 Murphy ..... B63B 35/38  
114/263

**OTHER PUBLICATIONS**

Nautibuoy Marine Brochure, uploaded online Feb. 2017, dated as Nov. 2016 [online], [site visited Nov. 25, 2019]. Available from Internet: <URL:http://http://baxtermarine.com/wp-content/uploads/2017/02/Nautibuoy-Brochure-Nov-2016.pdf> (Year: 2016).\*

(Continued)

*Primary Examiner* — Cynthia M. Chin  
(74) *Attorney, Agent, or Firm* — Optimus Patents US, LLC

(57) **CLAIM**

The ornamental design for a floating platform, as shown and described.

**DESCRIPTION**

FIG. 1 is a top perspective view of a floating platform; FIG. 2 is a bottom perspective view thereof; FIG. 3 is a left and right side view thereof; FIG. 4 is a front view thereof; FIG. 5 is a rear view thereof; FIG. 6 is top view thereof; and, FIG. 7 is a bottom view thereof.

The shading lines shown in the drawing represent the three-dimensional contour of the claimed design, and are not intended to indicate surface decoration.

**1 Claim, 7 Drawing Sheets**

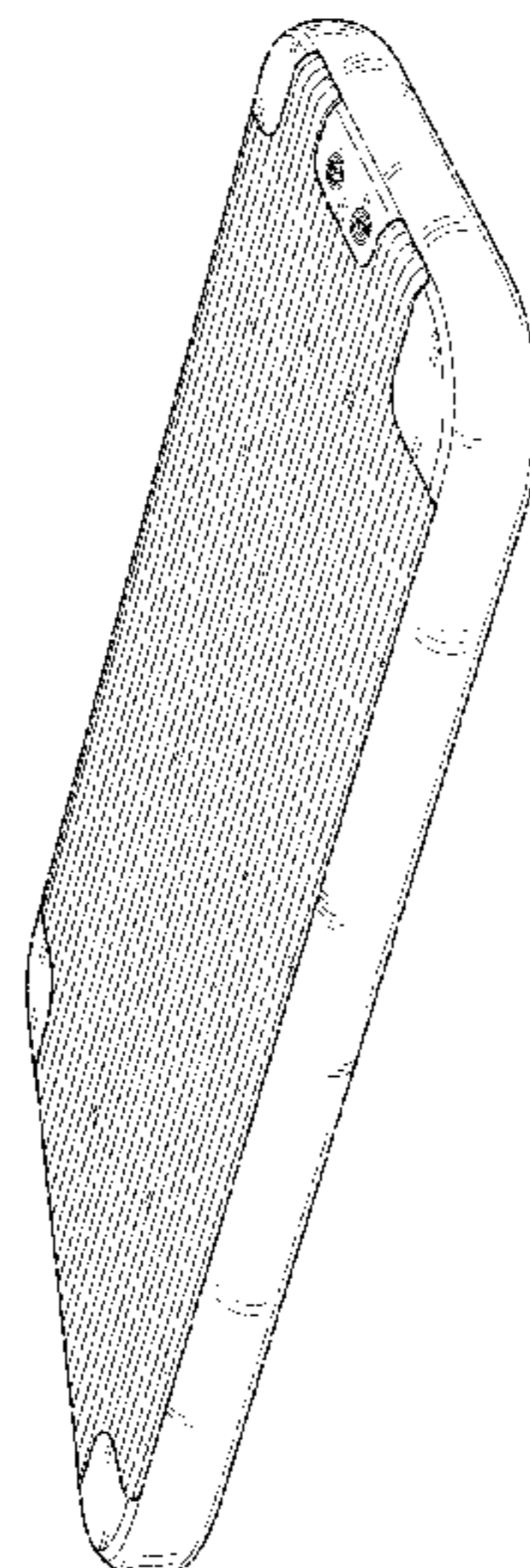

(56)

**References Cited**

U.S. PATENT DOCUMENTS

6,659,822 B1 \* 12/2003 Dombeck ..... B63B 34/00  
441/35  
6,805,066 B2 \* 10/2004 Johnson ..... B63B 35/58  
114/266  
D510,062 S \* 9/2005 McCormack ..... D12/316  
7,000,558 B2 \* 2/2006 Johnson ..... B63B 3/08  
114/266  
7,052,344 B1 \* 5/2006 Peterson ..... B29D 22/02  
441/40  
7,328,472 B2 \* 2/2008 Chaffee ..... A47C 7/021  
5/655.3  
7,357,688 B2 \* 4/2008 Ferrara ..... B63C 9/081  
441/35  
7,462,142 B1 \* 12/2008 Gordon ..... A63B 6/00  
482/142  
7,837,526 B1 \* 11/2010 Doffay ..... B63B 35/36  
441/40  
D629,484 S \* 12/2010 Jackson ..... D21/803  
7,867,049 B1 \* 1/2011 Doffay ..... B63B 35/58  
441/40

8,702,461 B1 \* 4/2014 d'Offay ..... B63B 35/58  
441/40  
D717,900 S \* 11/2014 Monroe ..... D21/803  
9,302,749 B1 \* 4/2016 D'Offay ..... B63B 7/082  
9,376,777 B2 \* 6/2016 Peterson ..... E01D 15/20  
9,688,364 B1 \* 6/2017 Fuqua ..... B63B 35/44  
10,293,897 B2 \* 5/2019 Ruiz ..... B63B 35/14  
D857,829 S \* 8/2019 Peterson ..... B63B 34/52  
D21/809  
10,392,084 B2 \* 8/2019 Wood ..... B63B 27/143  
2001/0036782 A1 \* 11/2001 Gredy ..... B63B 21/00  
441/129  
2003/0028971 A1 \* 2/2003 Chaffee ..... A47C 27/10  
5/706  
2019/0308698 A1 \* 10/2019 Builder ..... B63B 35/38  
2020/0039616 A1 \* 2/2020 Builder ..... B63B 32/83

OTHER PUBLICATIONS

Nautiboy platform—"NautiBuoy charms at SCIBS" uploaded online  
May 2016 [site visited Jan. 5, 2020]. Available from Internet:  
<URL: <https://superiorjetties.com/2016/05/>> (Year: 2016).\*

\* cited by examiner

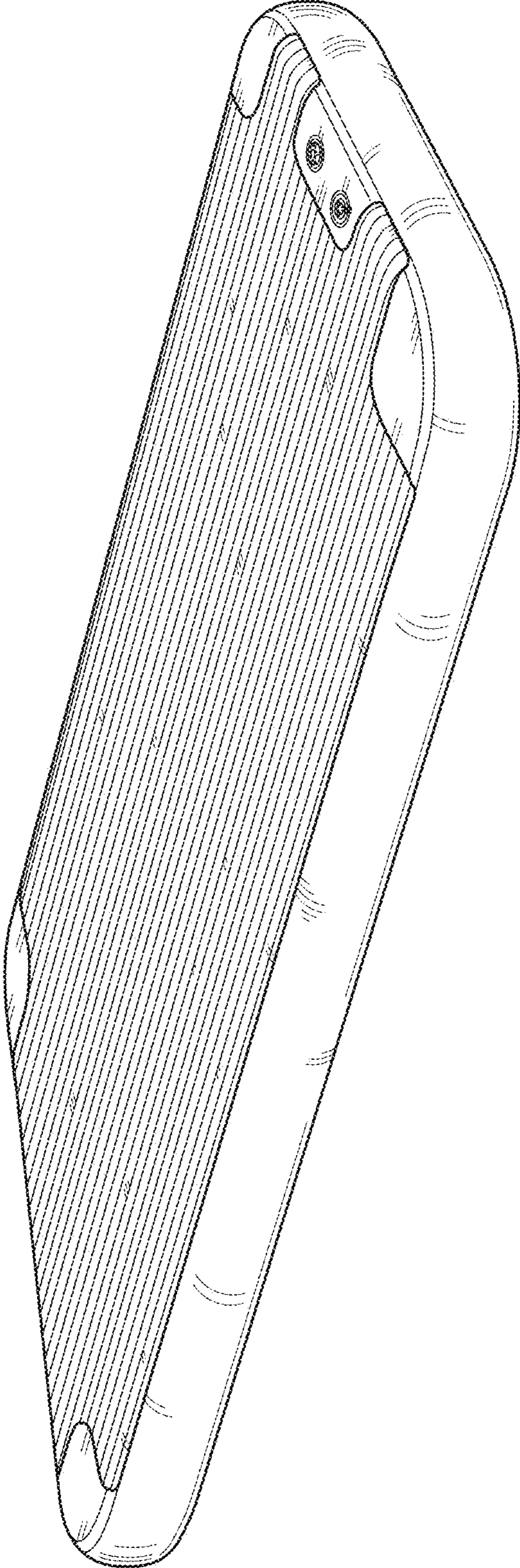

FIG. 1

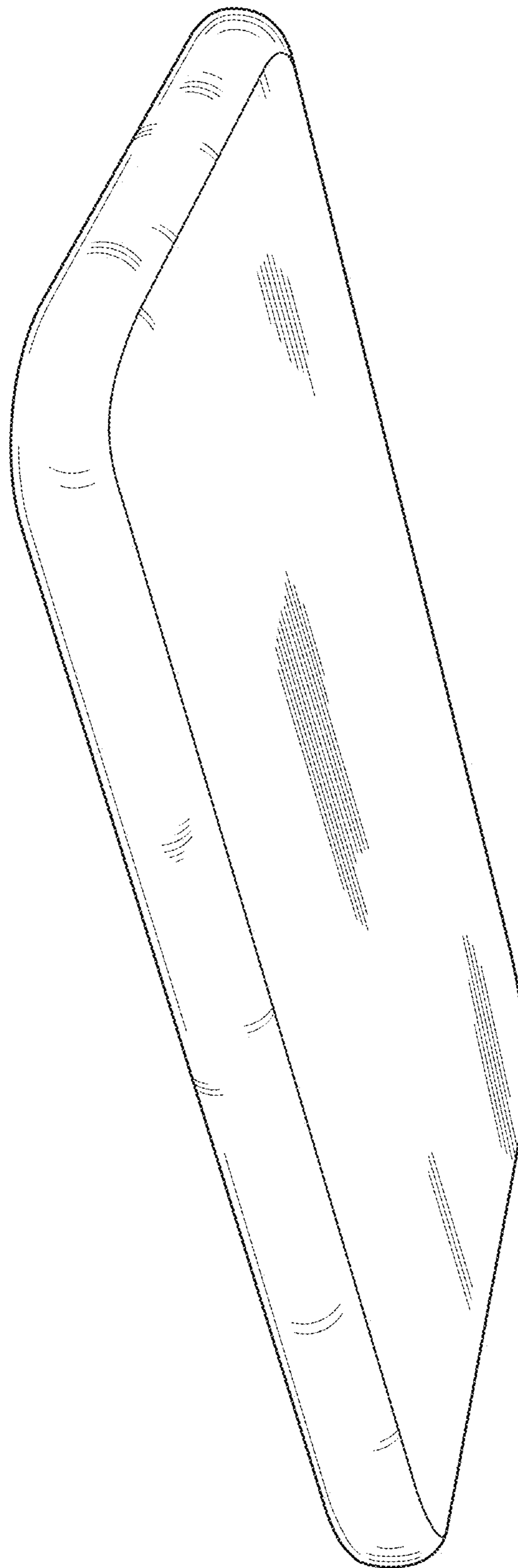

FIG. 2

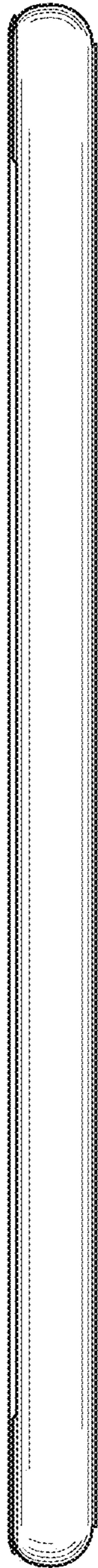

FIG. 3

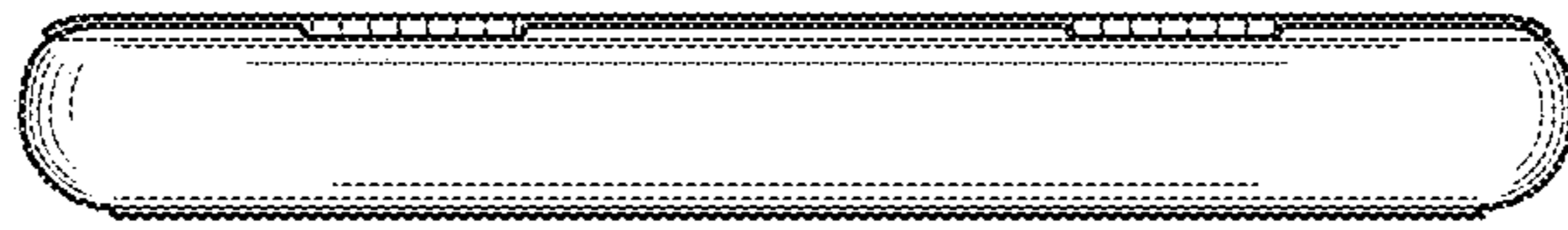

FIG. 4



FIG. 5

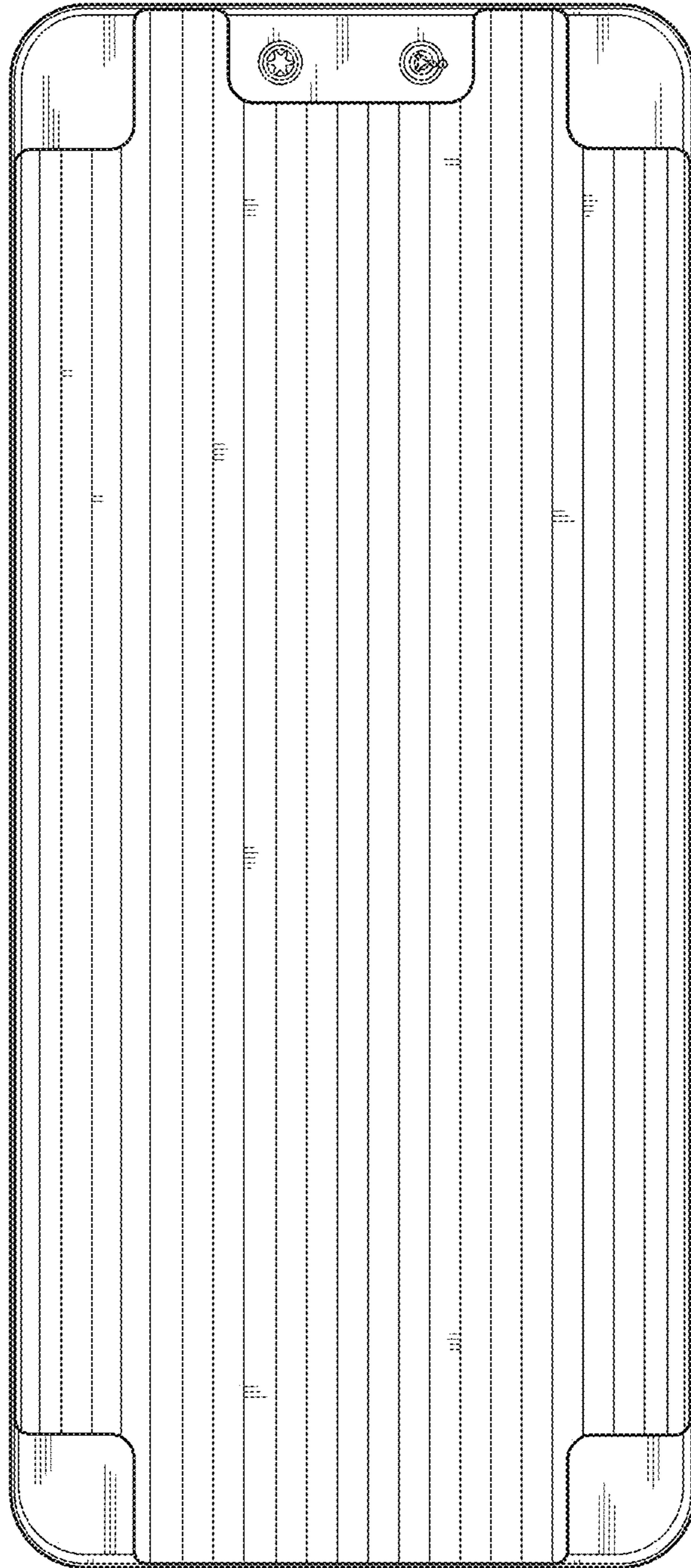

FIG. 6



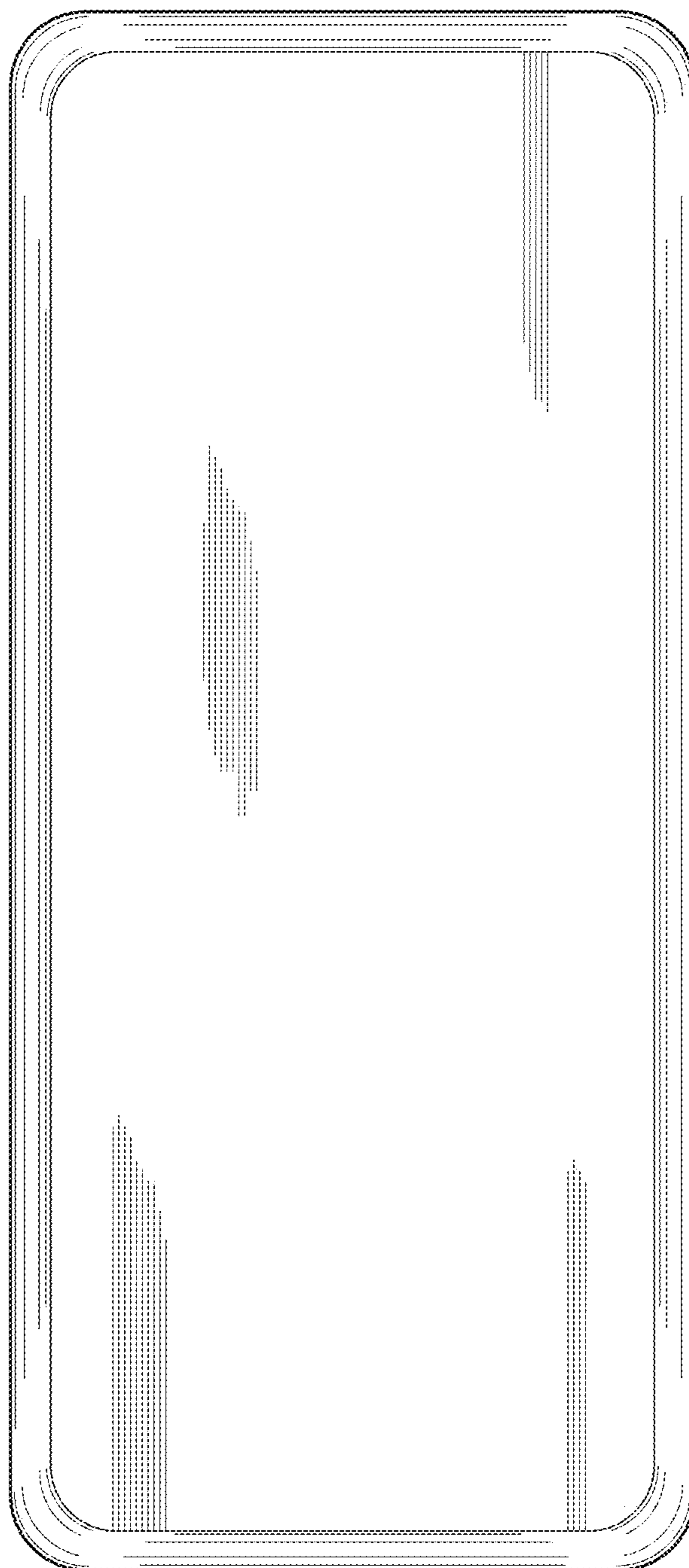

FIG. 7