



US00D913123S

(12) **United States Design Patent**
Okamura et al.

(10) **Patent No.:** **US D913,123 S**

(45) **Date of Patent:** **** Mar. 16, 2021**

(54) **WATCH**

(71) Applicant: **Citizen Watch Co., Ltd.**, Nishitokyo (JP)

(72) Inventors: **Naoaki Okamura**, Kokubunji (JP);
Izumi Kubo, Tokyo (JP)

(73) Assignee: **Citizen Watch Co., Ltd.**, Tokyo (JP)

(**) Term: **15 Years**

(21) Appl. No.: **29/688,754**

(22) Filed: **Apr. 24, 2019**

(30) **Foreign Application Priority Data**

Mar. 8, 2019 (JP) 2019-004926

(51) **LOC (13) Cl.** **10-02**

(52) **U.S. Cl.**
USPC **D10/39**

(58) **Field of Classification Search**

USPC D10/30-39, 65, 70, 98, 121-124, 126,
D10/128, 131-132

CPC G04B 19/00; G04B 19/025; G04B 19/04;
G04B 19/048; G04B 19/08; G04B 19/06;
G04B 19/065; G04B 19/085; G04B
19/087; G04B 19/10; G04B 19/12; G04B
19/18; G04B 19/20; G04B 19/226; G04B
19/22; G04B 19/23; G04B 37/00; G04B
37/008; G04B 37/0058; G04B 37/1486;
G04B 45/00; G04B 45/02; G04B
45/0038; G04B 45/0069; G04B 45/0076;
G04B 27/02; G04B 27/002; G04B
27/004; G04G 19/06; G04G 19/065;
G04G 19/087

See application file for complete search history.

(56) **References Cited**

U.S. PATENT DOCUMENTS

D295,387 S * 4/1988 Kumagai D10/30
D321,835 S * 11/1991 Hirabayashi D10/39

D474,118 S * 5/2003 Monachon D10/32
D668,162 S * 10/2012 Inoue D10/39
D702,136 S * 4/2014 Monachon D10/39

(Continued)

FOREIGN PATENT DOCUMENTS

JP D1508394 S 10/2014

OTHER PUBLICATIONS

Patek Philippe Calatrava 5127 | posted at Christies.com; no posting date watch circa 2008 [online]. ©Christie'S 2019 [retrieved Dec. 8, 2019] from Internet: <<https://www.christies.com/features/Watches-Deconstructed-Patek-Philippe-Calatrava-5127-5323-1.aspx>> (Year: 2008).*

(Continued)

Primary Examiner — Katherine Glennon

(74) *Attorney, Agent, or Firm* — RatnerPrestia

(57) **CLAIM**

The ornamental design for a watch, as shown and described.

DESCRIPTION

FIG. 1 is a front perspective view of a watch showing our new design;

FIG. 2 is a front elevational view thereof;

FIG. 3 is a left side elevational view thereof;

FIG. 4 is a right side elevational view thereof;

FIG. 5 is a rear elevational view thereof;

FIG. 6 is a top plan view thereof;

FIG. 7 is a bottom plan view thereof;

FIG. 8 is a rear perspective view thereof;

FIG. 9 is another front view thereof; and,

FIG. 10 is a cross-sectional view taken along the line 10-10 in FIG. 9.

The broken lines shown in FIGS. 3, 4, 5, 8, and 10 show portions of the watch that form no part of the claimed design.

1 Claim, 8 Drawing Sheets

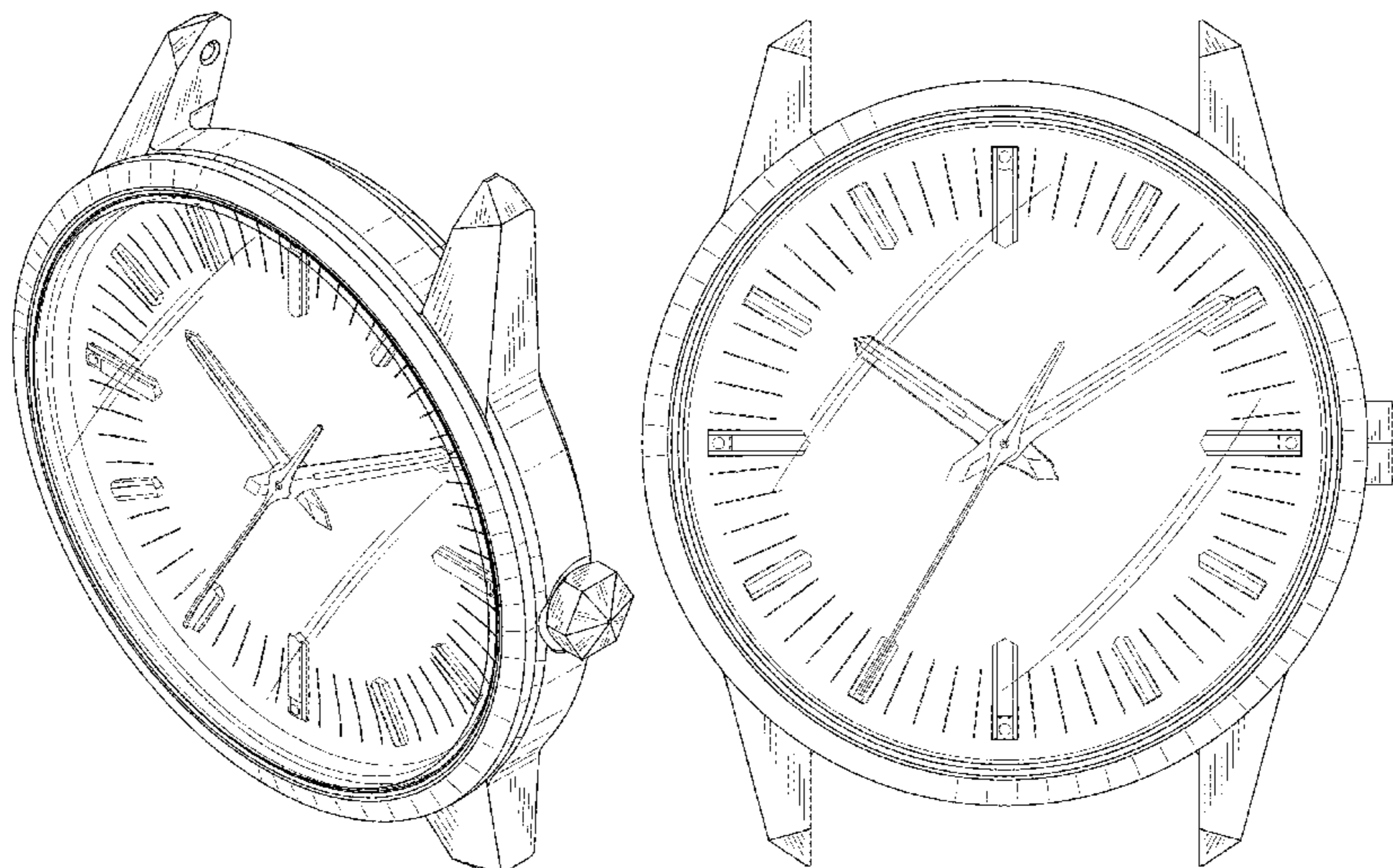

(56)

References Cited

U.S. PATENT DOCUMENTS

D736,655 S * 8/2015 Monachon D10/39
 D740,696 S * 10/2015 Monachon D10/39
 D743,827 S * 11/2015 Prince D10/122
 D744,863 S * 12/2015 Behling D10/30
 D748,501 S * 2/2016 Cerrato D10/30
 D761,130 S * 7/2016 Soares D10/32
 D779,342 S * 2/2017 Lintz D10/30
 D801,196 S * 10/2017 Sugiura D10/39
 D807,762 S * 1/2018 Sugiura D10/30
 9,857,774 B2 * 1/2018 Ninomiya G05F 3/16
 D827,453 S * 9/2018 Davoli D10/37
 D827,474 S * 9/2018 Monachon D10/126
 D831,509 S 10/2018 Sasaki
 D831,519 S * 10/2018 Monachon D10/126
 D834,980 S * 12/2018 Le Bot D10/126
 D849,565 S * 5/2019 Behling D10/39

D880,336 S * 4/2020 Behling D10/126
 2017/0075306 A1 * 3/2017 Morohoshi G04C 17/00
 2018/0231942 A1 * 8/2018 Sawada G04B 33/00

OTHER PUBLICATIONS

Grand Seiko Hi-beat 36000 GMT | posted by Angus Davies at escapementmagazine.com Apr. 2014 [online][site visited Jun. 21, 2018]. Available from internet: <<https://www.escapementmagazine.com/articles/grand-seiko-hi-beat-36000-gmt-limited-editionsbgj005-in-depth-watch-review-by-escapement.html/>> (Year: 2014).*

Introducing the Citizen Eco-Drive Caliber 0100 | posted at Hodinkee.com Apr. 2019 [online]. © 2009-2020 Hodinkee Inc. [retrieved Oct. 10, 2020] from Internet: <<https://www.hodinkee.com/articles/citizen-eco-drive-caliber-0100-introducing>> (Year: 2019).*

Rolex Quartz Texano Ref 5100 | posted at rolexpassionmarket.com; watch c.1970s [online]. ©2020 Rolex Passion Market [retrieved Oct. 10, 2020] from Internet: <<https://rolexpassionmarket.com/watches/rolex-quartz-texano-ref-5100/>> (Year: 1979).*

* cited by examiner

FIG. 1

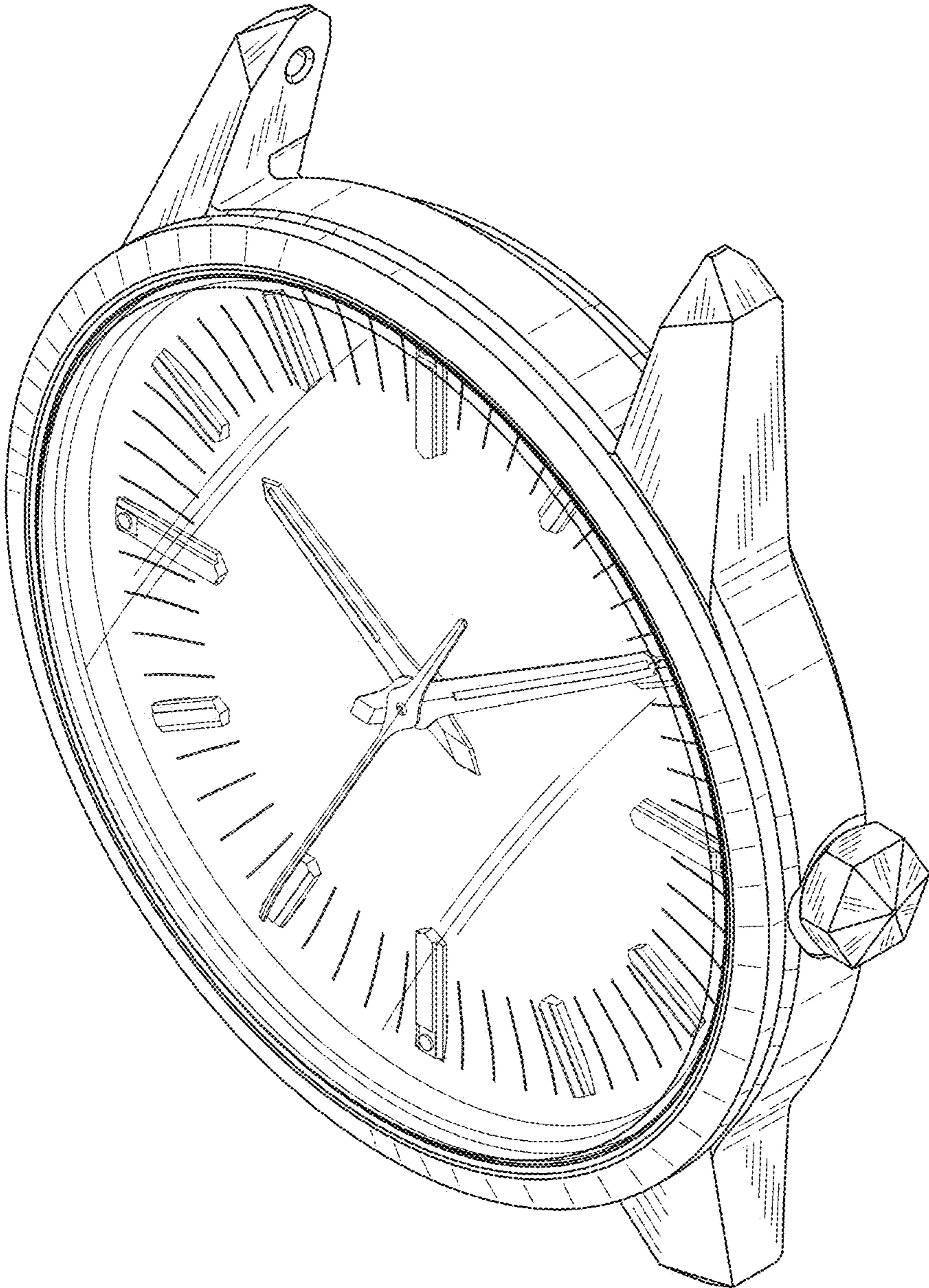

FIG. 2

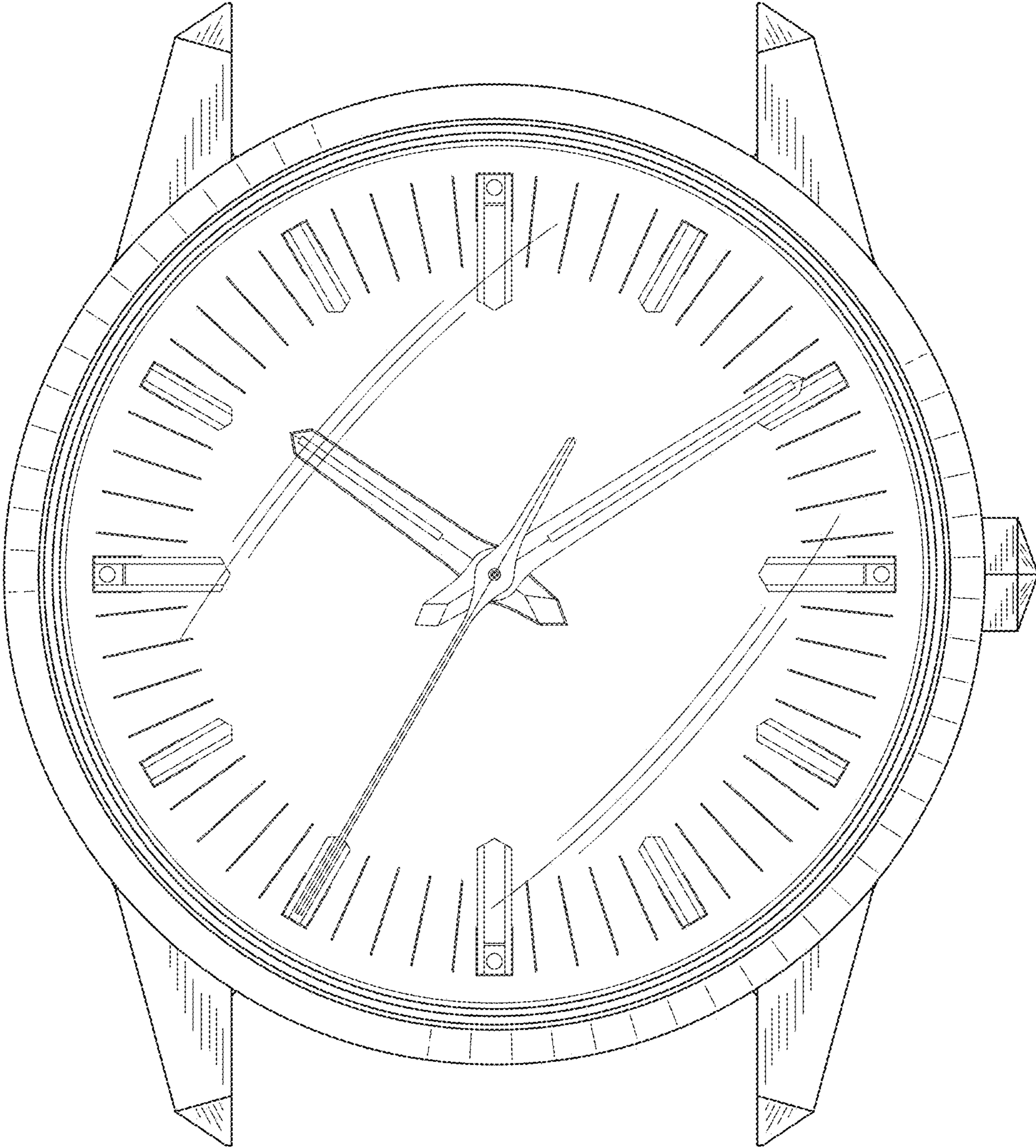

FIG. 3

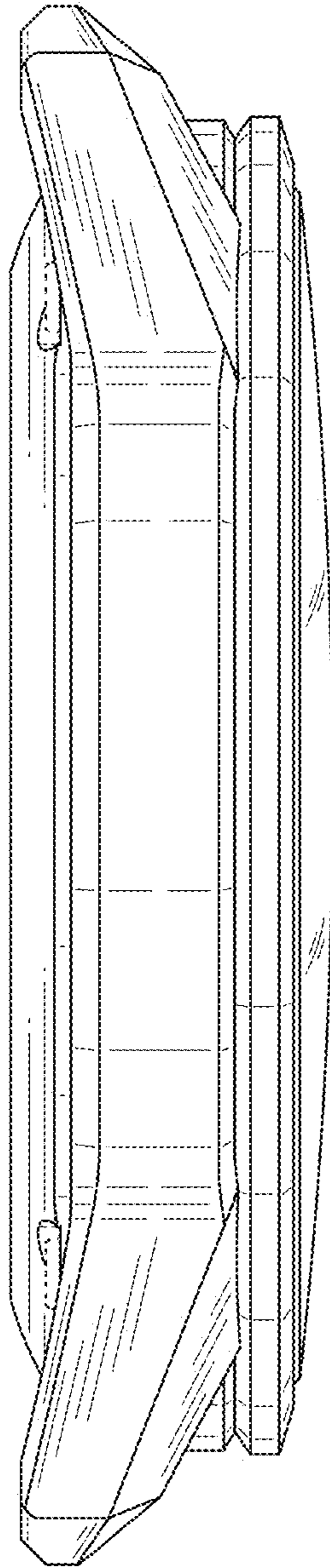

FIG. 4

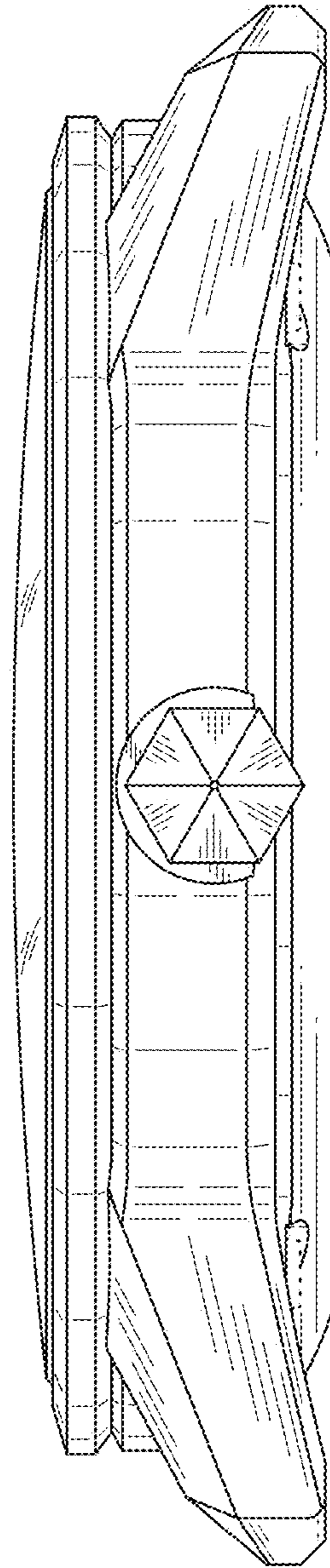

FIG. 5

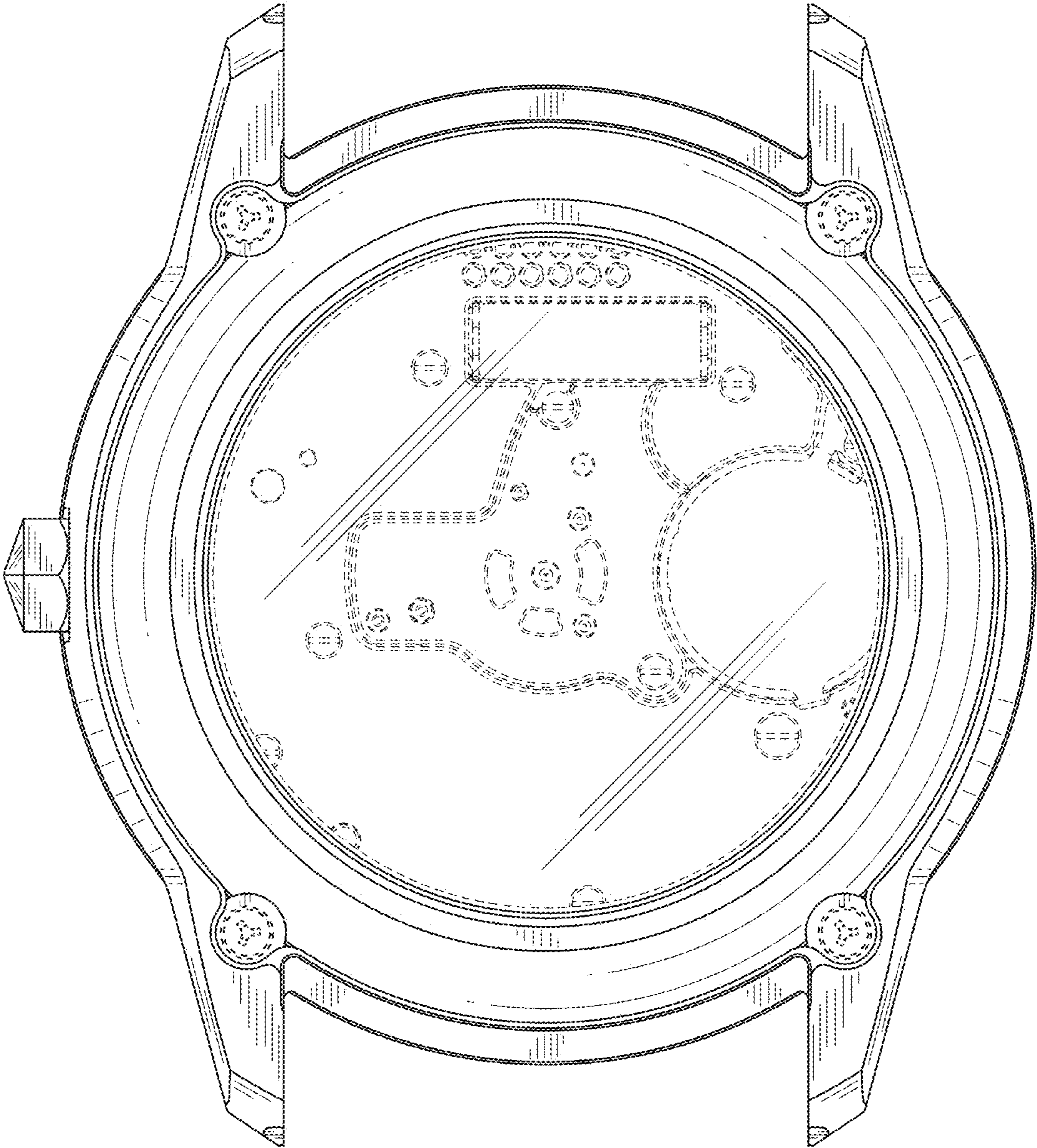

FIG. 6

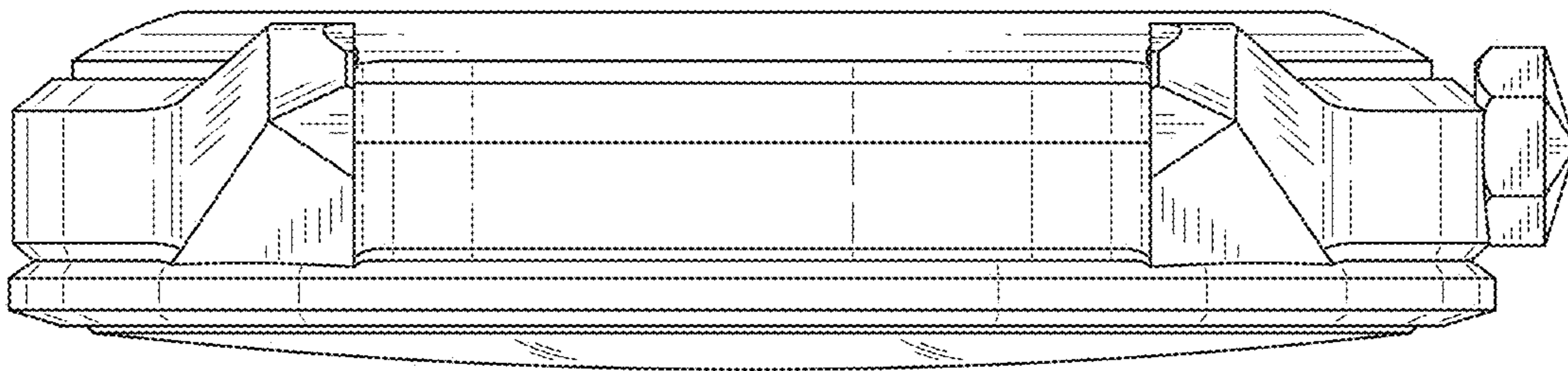

FIG. 7

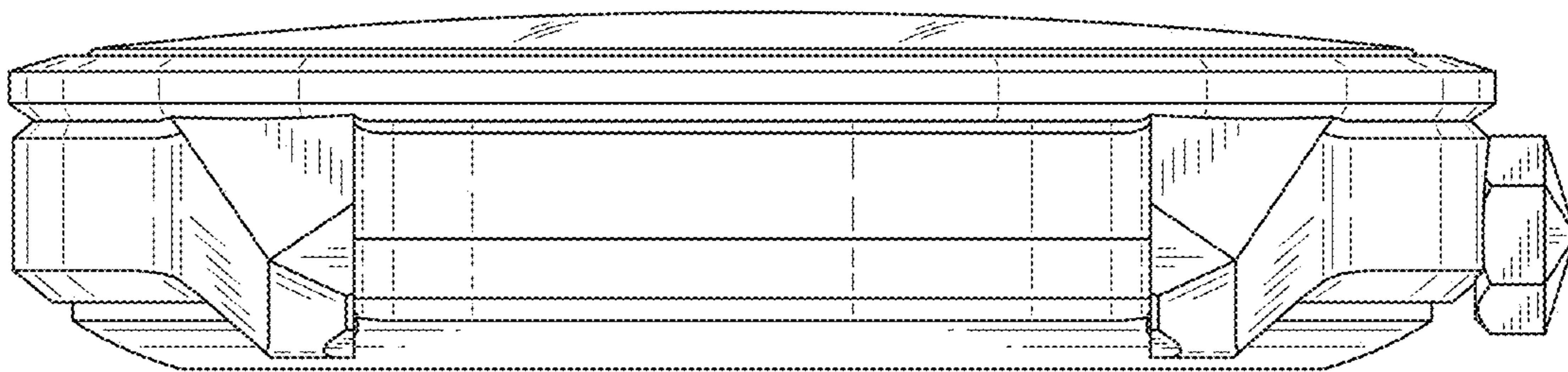

FIG. 8



FIG. 9

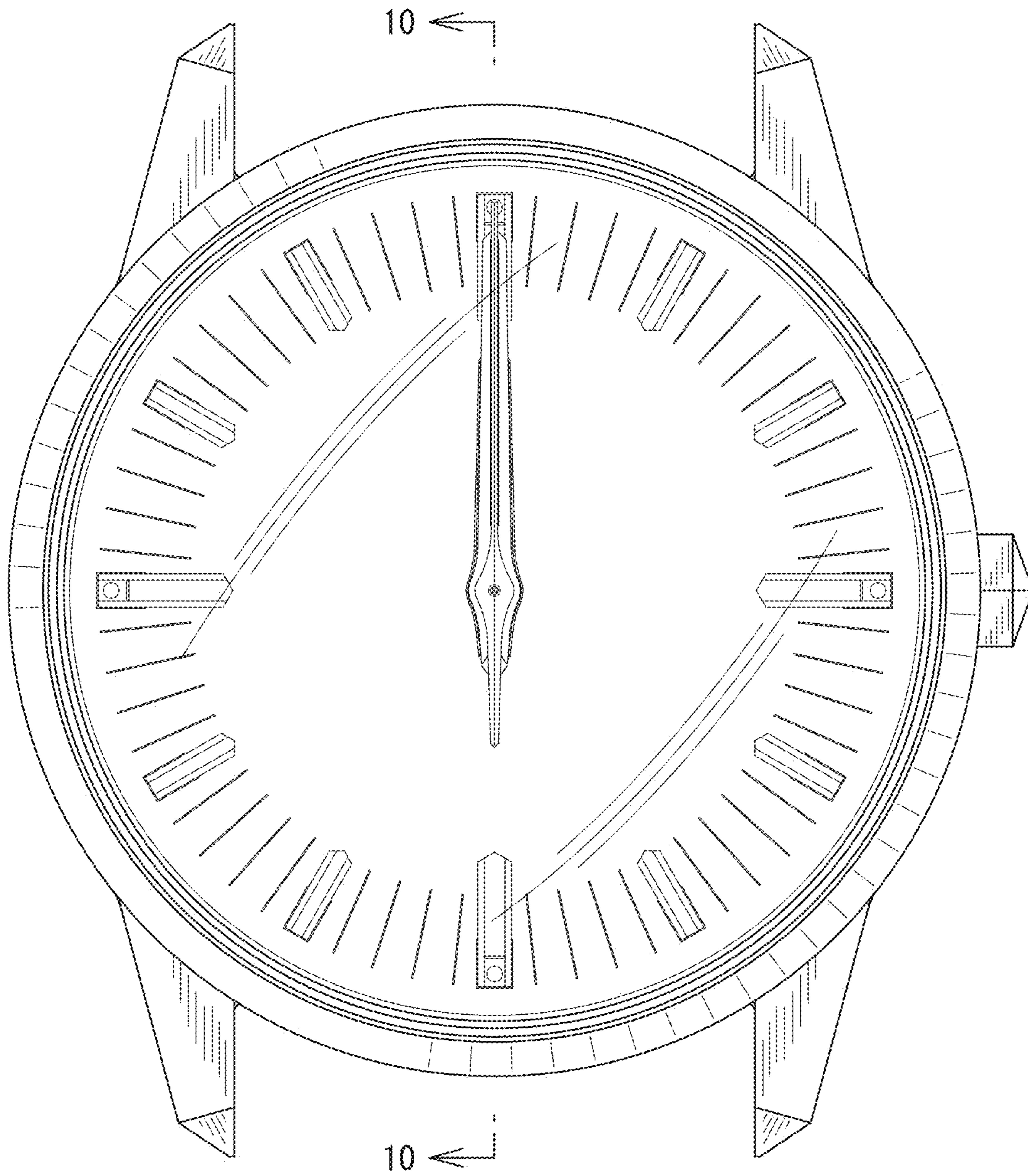

FIG. 10

