



US00D913106S

(12) **United States Design Patent**
Willard et al.

(10) **Patent No.:** **US D913,106 S**
(45) **Date of Patent:** **** Mar. 16, 2021**

(54) **CONTAINER WITH EARS**

(71) Applicant: **BIG HEART PET, INC.**, Orrville, OH (US)
(72) Inventors: **Zachary Parker Willard**, Akron, OH (US); **Julius Austria Coronel**, Copley, OH (US); **Yunlin Song**, Auburn, AL (US)
(73) Assignee: **BIG HEART PET, INC.**, Orrville, OH (US)

(**) Term: **15 Years**

(21) Appl. No.: **29/678,704**

(22) Filed: **Jan. 30, 2019**

(51) **LOC (13) Cl.** **09-01**

(52) **U.S. Cl.**
USPC **D9/607; D9/609; D9/611; D9/426; D9/428**

(58) **Field of Classification Search**
USPC **D9/600-601, 607-613, 500-505, 516, D9/702, 707-710, 414-429; 206/457,**
(Continued)

(56) **References Cited**

U.S. PATENT DOCUMENTS

5,992,619 A * 11/1999 Milano B65D 75/322
206/216
D457,318 S * 5/2002 Borland D3/303
(Continued)

OTHER PUBLICATIONS

Whiskas Temptations Chicken & Cheese Cat Treats; Web Page
https://www.pets.ie/p/whiskas-temptations---chicken-and-cheese-cat-treats/11126_0925p; 1 page; Jul. 2008; retrieved from Internet Archive on Nov. 10, 2020.

(Continued)

Primary Examiner — Sandra L Morris

(74) *Attorney, Agent, or Firm* — Michael A. Olshavsky

(57) **CLAIM**

The ornamental design of a container with ears, as shown and described.

DESCRIPTION

FIG. 1 is a front perspective view of a design of a container with ears.
FIG. 2 is a rear perspective view of the container with ears shown in FIG. 1.
FIG. 3 is a front view of the container with ears shown in FIG. 1.
FIG. 4 is a rear view of the container with ears shown in FIG. 1.
FIG. 5 is a left side view of the container with ears shown in FIG. 1.
FIG. 6 is a right side view of the container with ears shown in FIG. 1.
FIG. 7 is a top plan view of the container with ears shown in FIG. 1.
FIG. 8 is a bottom plan view of the container with ears shown in FIG. 1.
FIG. 9 is a front perspective view of a design of a container with ears.
FIG. 10 is a rear perspective view of the container with ears shown in FIG. 9.
FIG. 11 is a front view of the container with ears shown in FIG. 9.
FIG. 12 is a rear view of the container with ears shown in FIG. 9.
FIG. 13 is a left side view of the container with ears shown in FIG. 9.
FIG. 14 is a right side view of the container with ears shown in FIG. 9.
FIG. 15 is a top plan view of the container with ears shown in FIG. 9.
FIG. 16 is a bottom plan view of the container with ears shown in FIG. 9.
FIG. 17 is a front perspective view of a design of a container with ears.

(Continued)

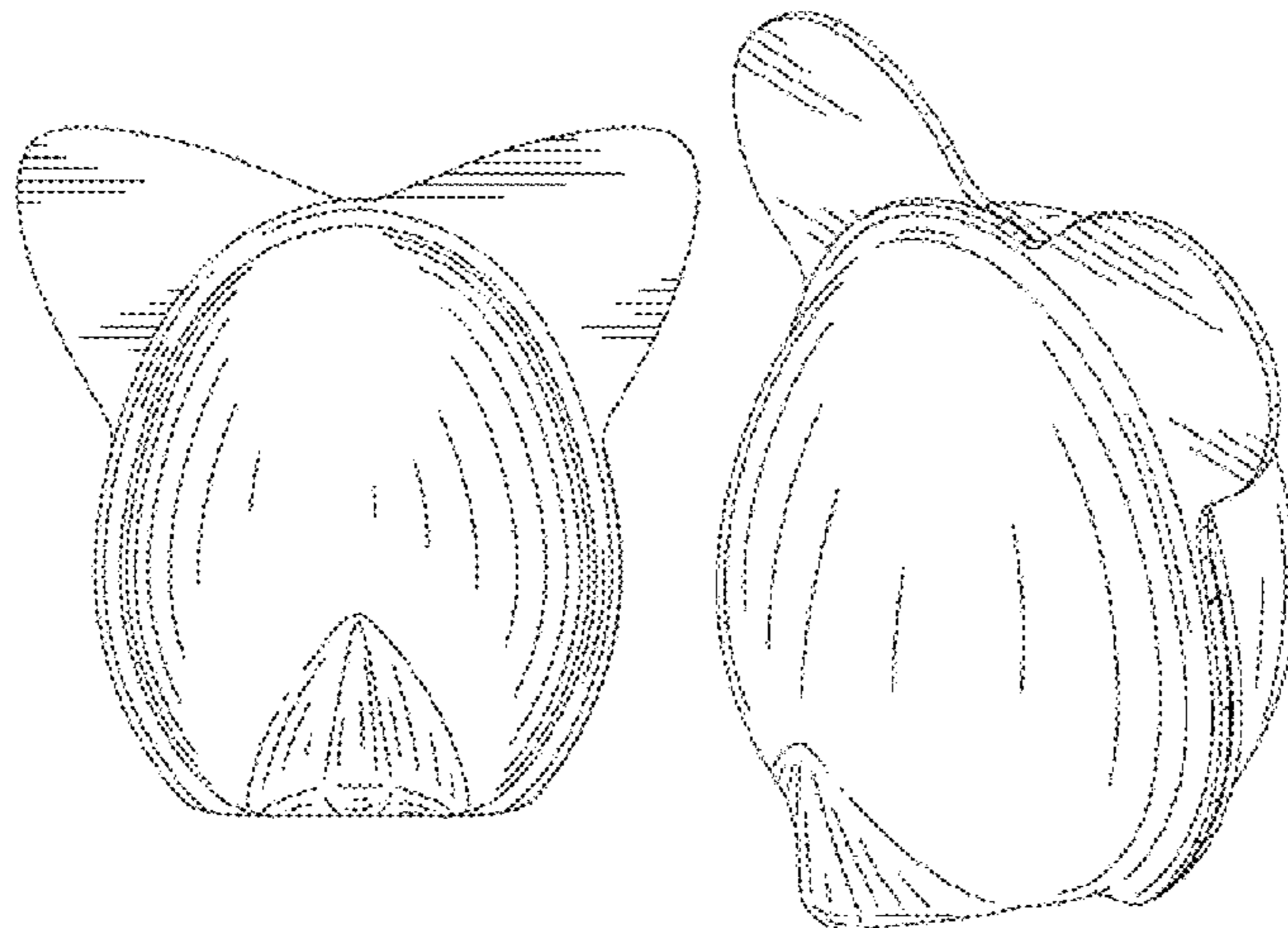

FIG. 18 is a rear perspective view of the container with ears shown in FIG. 17.
 FIG. 19 is a front view of the container with ears shown in FIG. 17.
 FIG. 20 is a rear view of the container with ears shown in FIG. 17.
 FIG. 21 is a left side view of the container with ears shown in FIG. 17.
 FIG. 22 is a right side view of the container with ears shown in FIG. 17.
 FIG. 23 is a top plan view of the container with ears shown in FIG. 17.
 FIG. 24 is a bottom plan view of the container with ears shown in FIG. 17.
 FIG. 25 is a front perspective view of a design of a container with ears.
 FIG. 26 is a rear perspective view of the container with ears shown in FIG. 25.
 FIG. 27 is a front view of the container with ears shown in FIG. 25.
 FIG. 28 is a rear view of the container with ears shown in FIG. 25.
 FIG. 29 is a left side view of the container with ears shown in FIG. 25.
 FIG. 30 is a right side view of the container with ears shown in FIG. 25.
 FIG. 31 is a top plan view of the container with ears shown in FIG. 25.
 FIG. 32 is a bottom plan view of the container with ears shown in FIG. 25.
 FIG. 33 is a front perspective view of a design of a container with ears.
 FIG. 34 is a rear perspective view of the container with ears shown in FIG. 33.
 FIG. 35 is a front view of the container with ears shown in FIG. 33.
 FIG. 36 is a rear view of the container with ears shown in FIG. 33.
 FIG. 37 is a left side view of the container with ears shown in FIG. 33.
 FIG. 38 is a right side view of the container with ears shown in FIG. 33.
 FIG. 39 is a top plan view of the container with ears shown in FIG. 33.
 FIG. 40 is a bottom plan view of the container with ears shown in FIG. 33.
 FIG. 41 is a front perspective view of a design of a container with ears.
 FIG. 42 is a rear perspective view of the container with ears shown in FIG. 41.
 FIG. 43 is a front view of the container with ears shown in FIG. 41.
 FIG. 44 is a rear view of the container with ears shown in FIG. 41.
 FIG. 45 is a left side view of the container with ears shown in FIG. 41.
 FIG. 46 is a right side view of the container with ears shown in FIG. 41.

FIG. 47 is a top plan view of the container with ears shown in FIG. 41.
 FIG. 48 is a bottom plan view of the container with ears shown in FIG. 41.
 FIG. 49 is a front perspective view of a design of a container with ears.
 FIG. 50 is a rear perspective view of the container with ears shown in FIG. 49.
 FIG. 51 is a front view of the container with ears shown in FIG. 49.
 FIG. 52 is a rear view of the container with ears shown in FIG. 49.
 FIG. 53 is a left side view of the container with ears shown in FIG. 49.
 FIG. 54 is a right side view of the container with ears shown in FIG. 49.
 FIG. 55 is a top plan view of the container with ears shown in FIG. 49; and,
 FIG. 56 is a bottom plan view of the container with ears shown in FIG. 49.
 The broken lines in the figures are for the purpose of illustrating unclaimed portions of the container with ears and form no part of the claimed design.

1 Claim, 35 Drawing Sheets

(58) **Field of Classification Search**

USPC 206/494, 459.5, 527, 540; 229/116.1;
 215/381-384, 400; D7/514-521, 539,
 D7/544, 571, 594, 599, 604, 606, 613,
 D7/619.2, 623, 625, 628-630, 391-392.1,
 D7/396.4; D3/270-271.8
 CPC B65D 67/00; B65D 81/36; B65D 81/60;
 B65D 81/368; B65D 37/00; B65D 5/42;
 B65D 5/4208; B65D 77/00; A63H 33/10;
 A63H 33/16

See application file for complete search history.

(56) **References Cited**

U.S. PATENT DOCUMENTS

D475,288	S	*	6/2003	Hoffmann	D9/426
D526,121	S	*	8/2006	Nip	D3/271.2
D616,760	S	*	6/2010	Deuerer	D9/611
D687,316	S	*	8/2013	Panetta	D9/607
D693,625	S	*	11/2013	Facey	D7/354
D736,099	S	*	8/2015	Deuerer	D9/611
D743,805	S	*	11/2015	Glass	D9/611
D755,637	S	*	5/2016	Wetton	D9/643
D791,609	S	*	7/2017	Rotman	D9/611
D812,487	S	*	3/2018	Soegyanto	D9/702
D827,425	S	*	9/2018	Bercaw	D9/418

OTHER PUBLICATIONS

Whiskas Temptations Chicken & Cheese Treats; Mintel GNPD database; <http://www.gnpd.com>, Undated.

* cited by examiner



FIG. 1

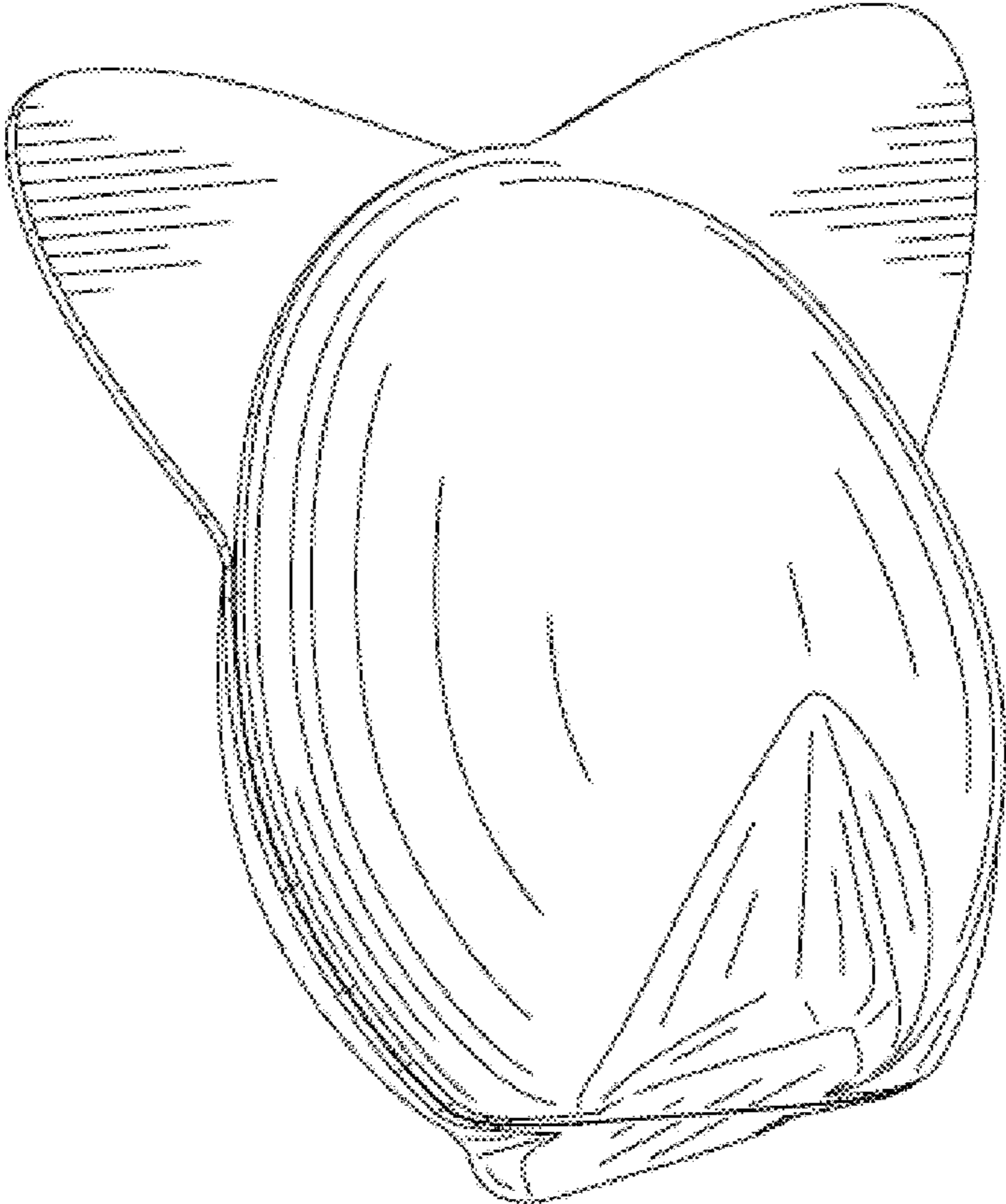

FIG. 2

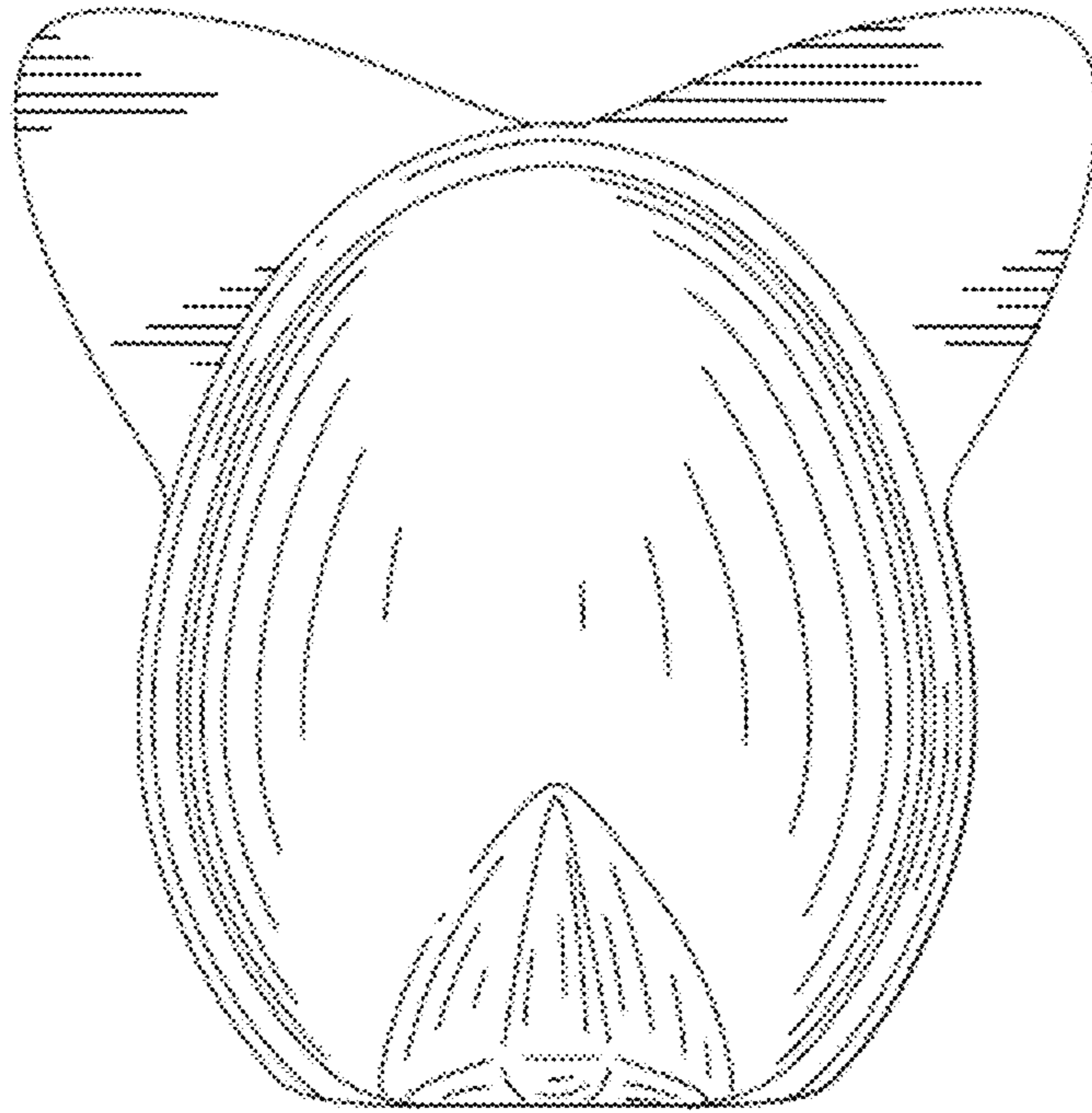

FIG. 3

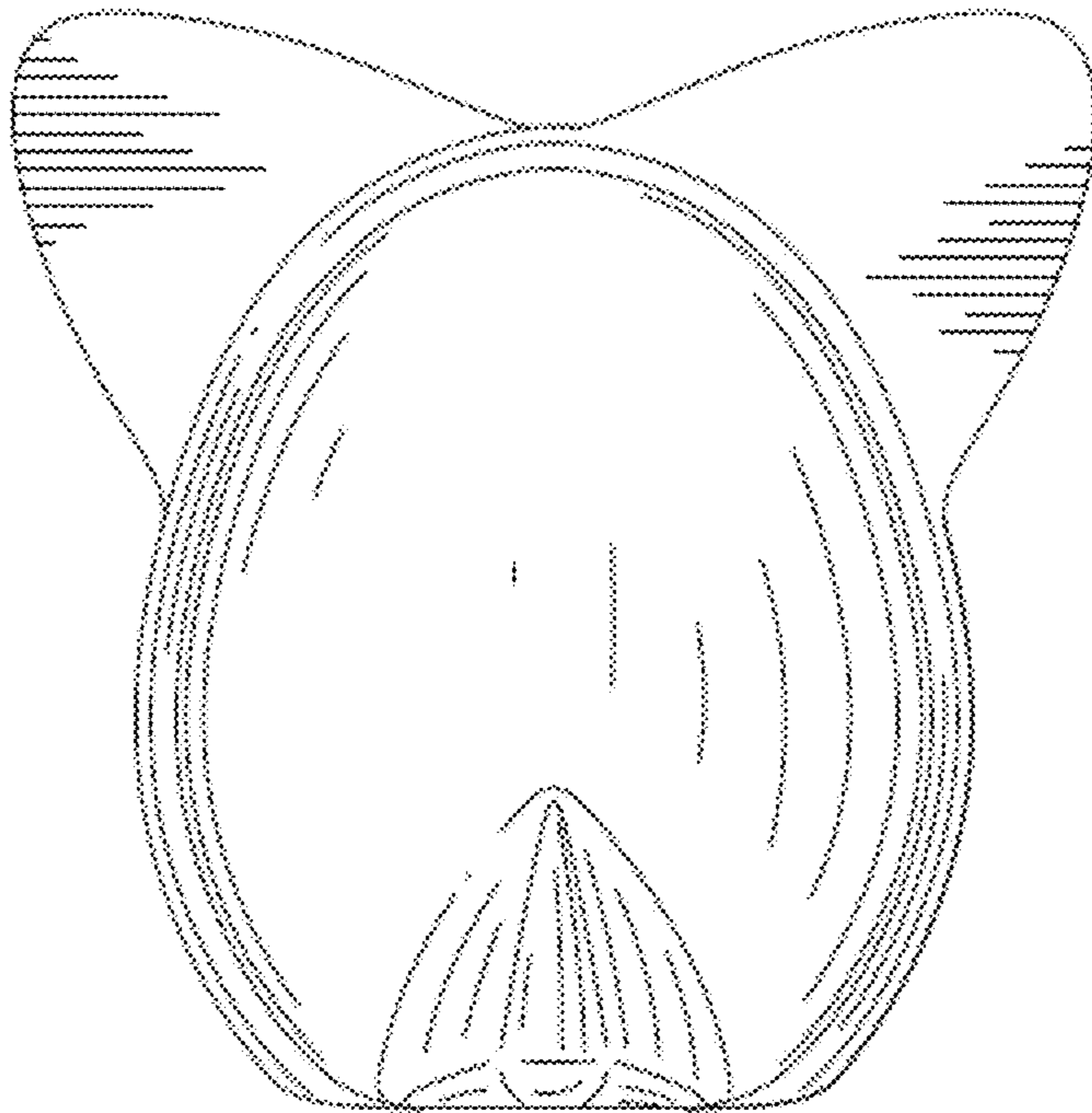

FIG. 4

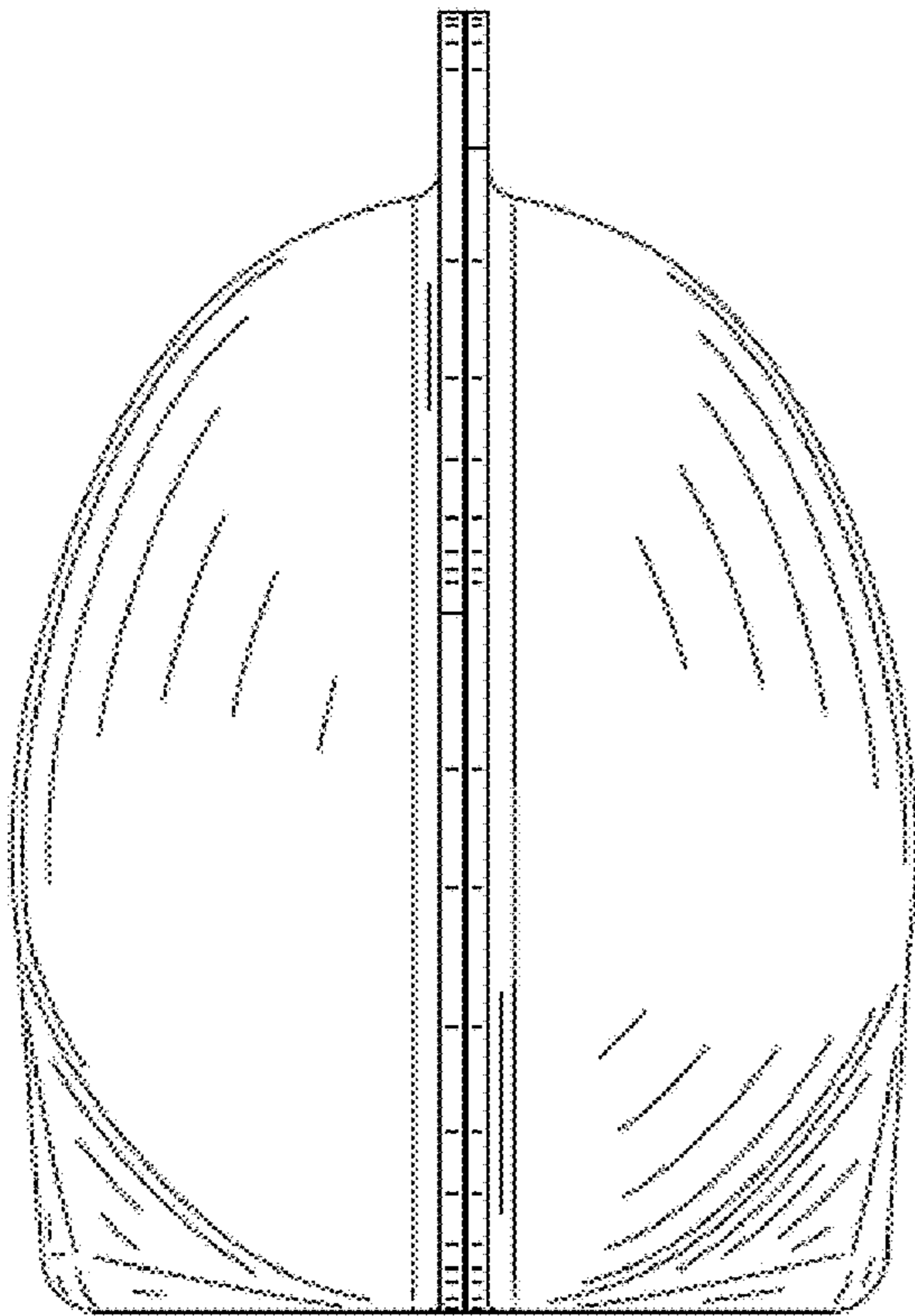

FIG. 5

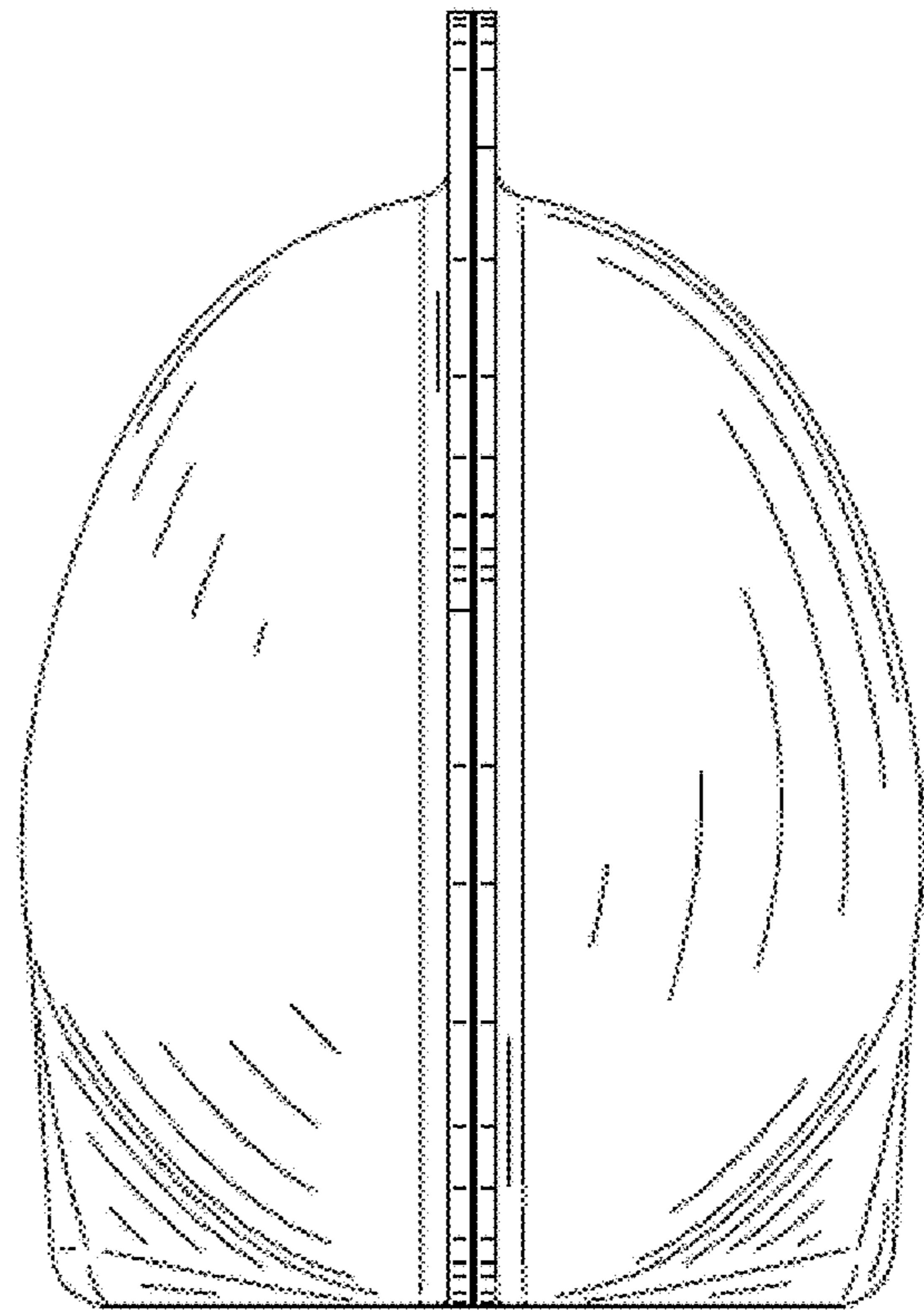

FIG. 6

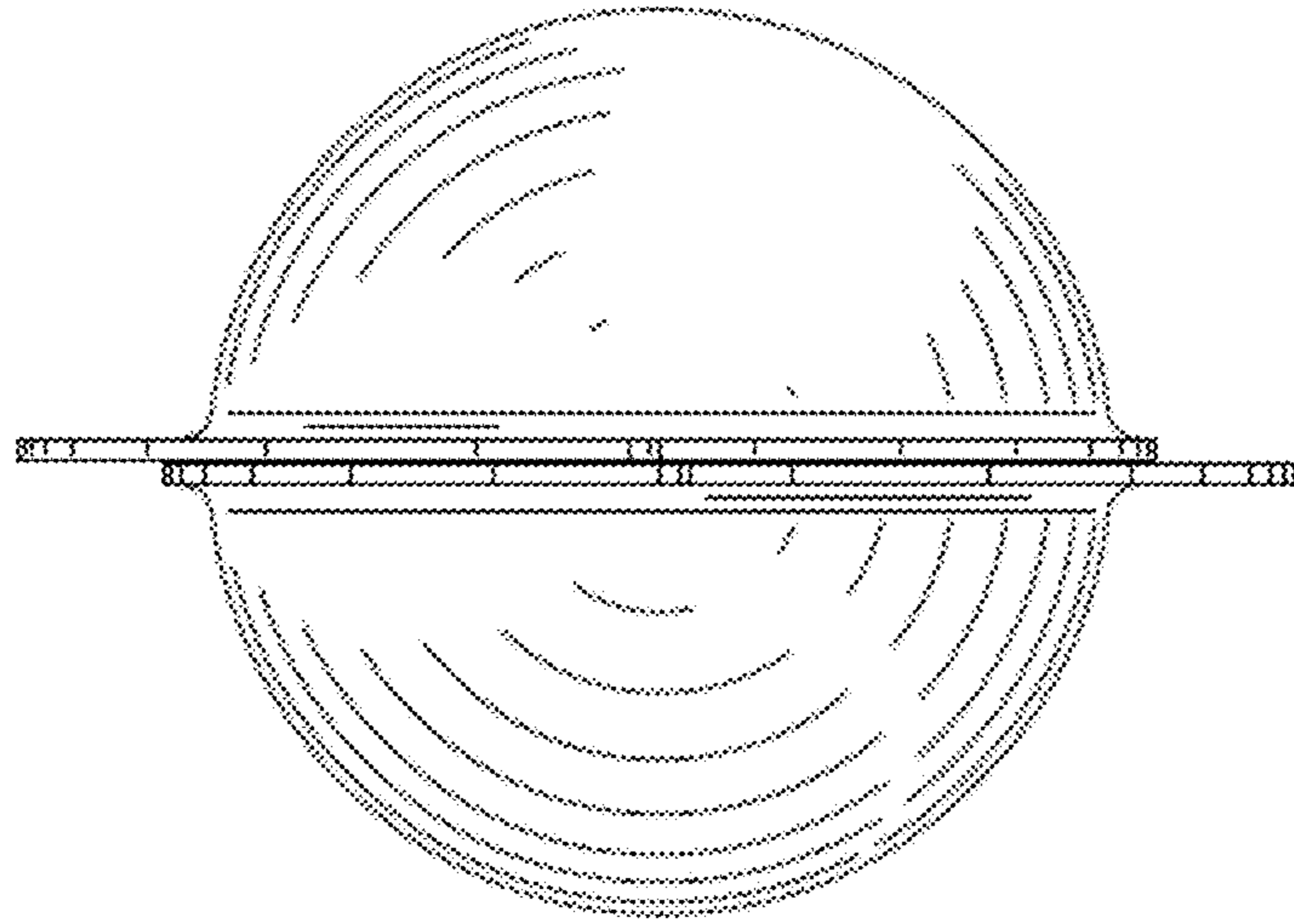

FIG. 7

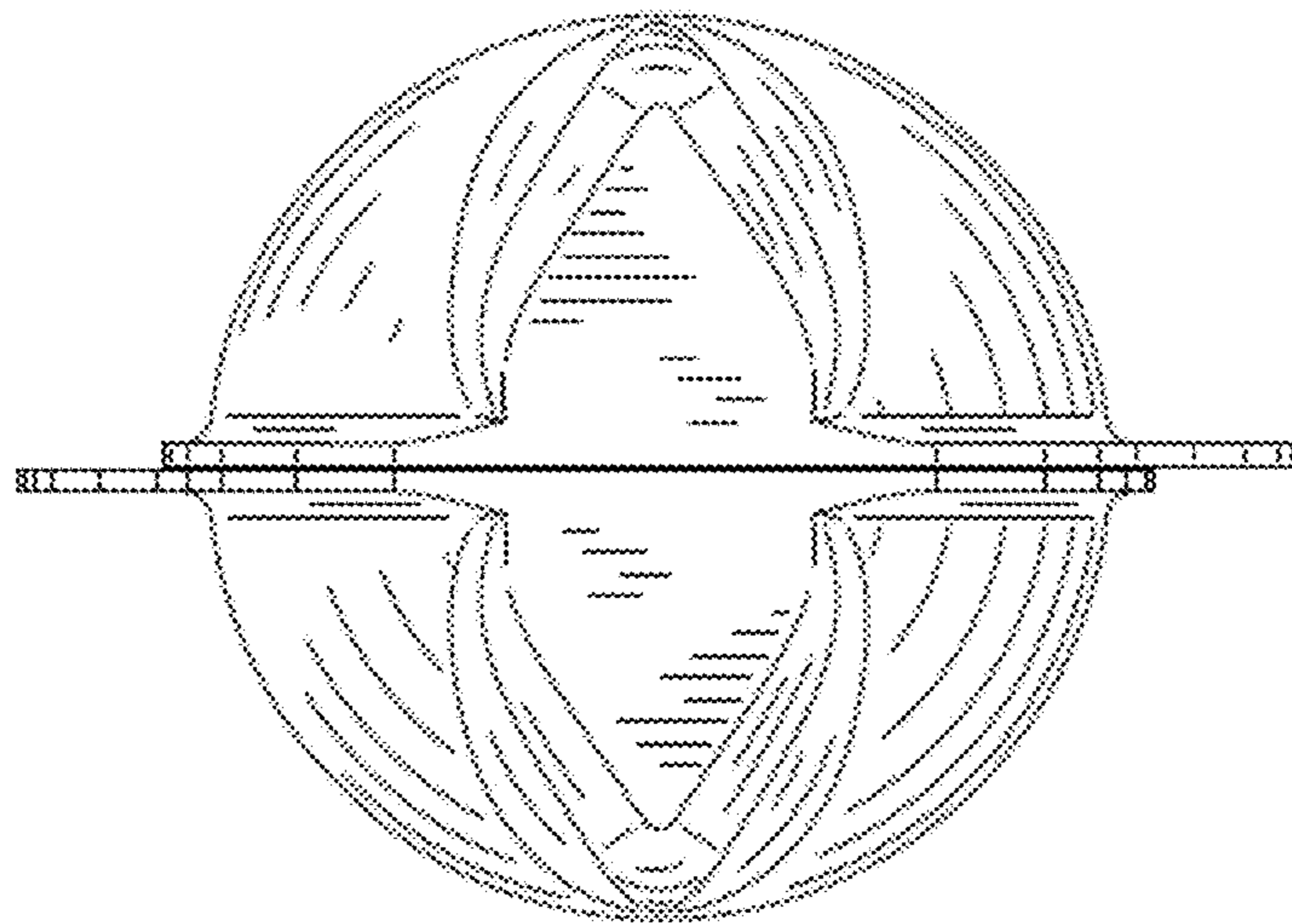

FIG. 8

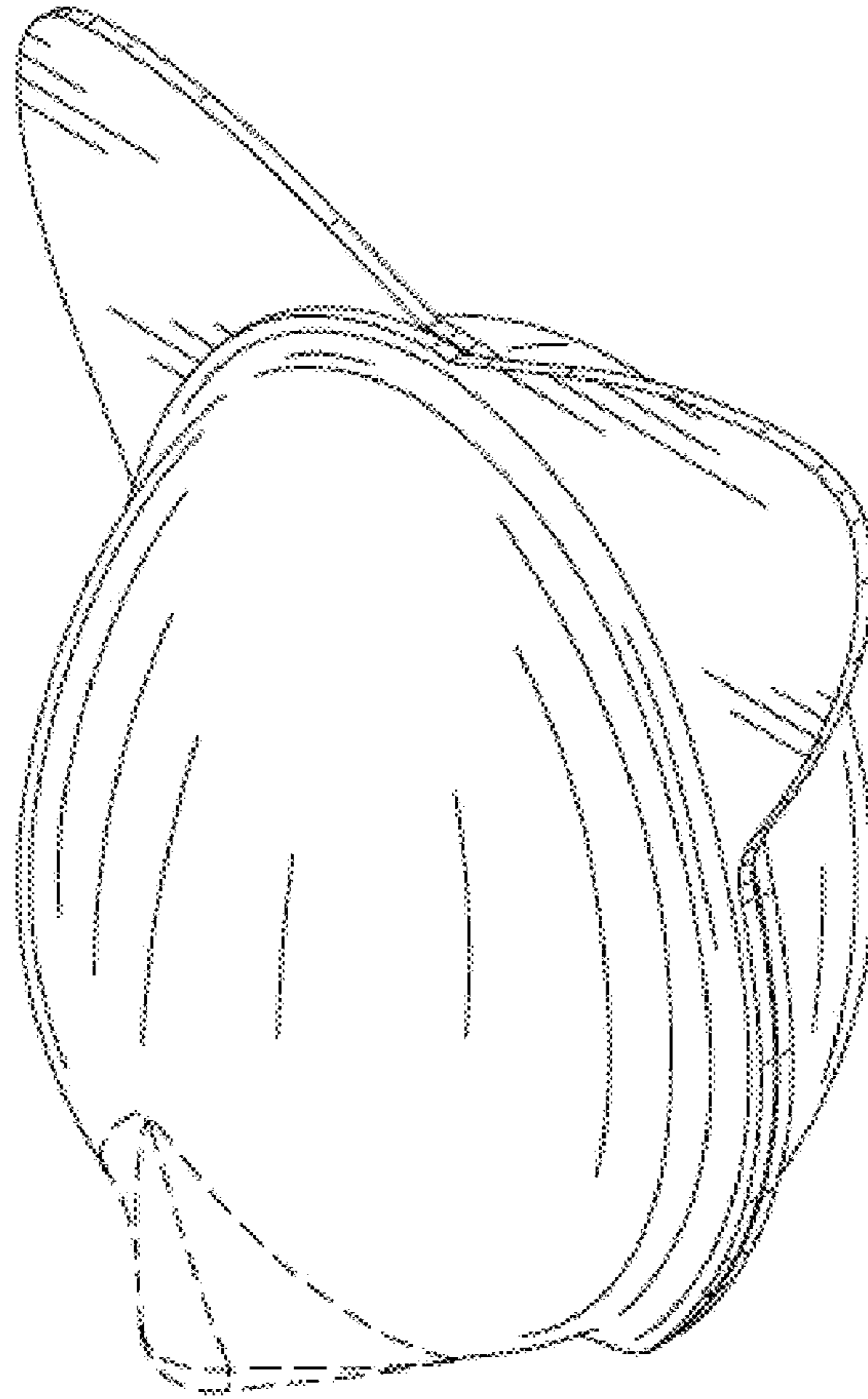

FIG. 9

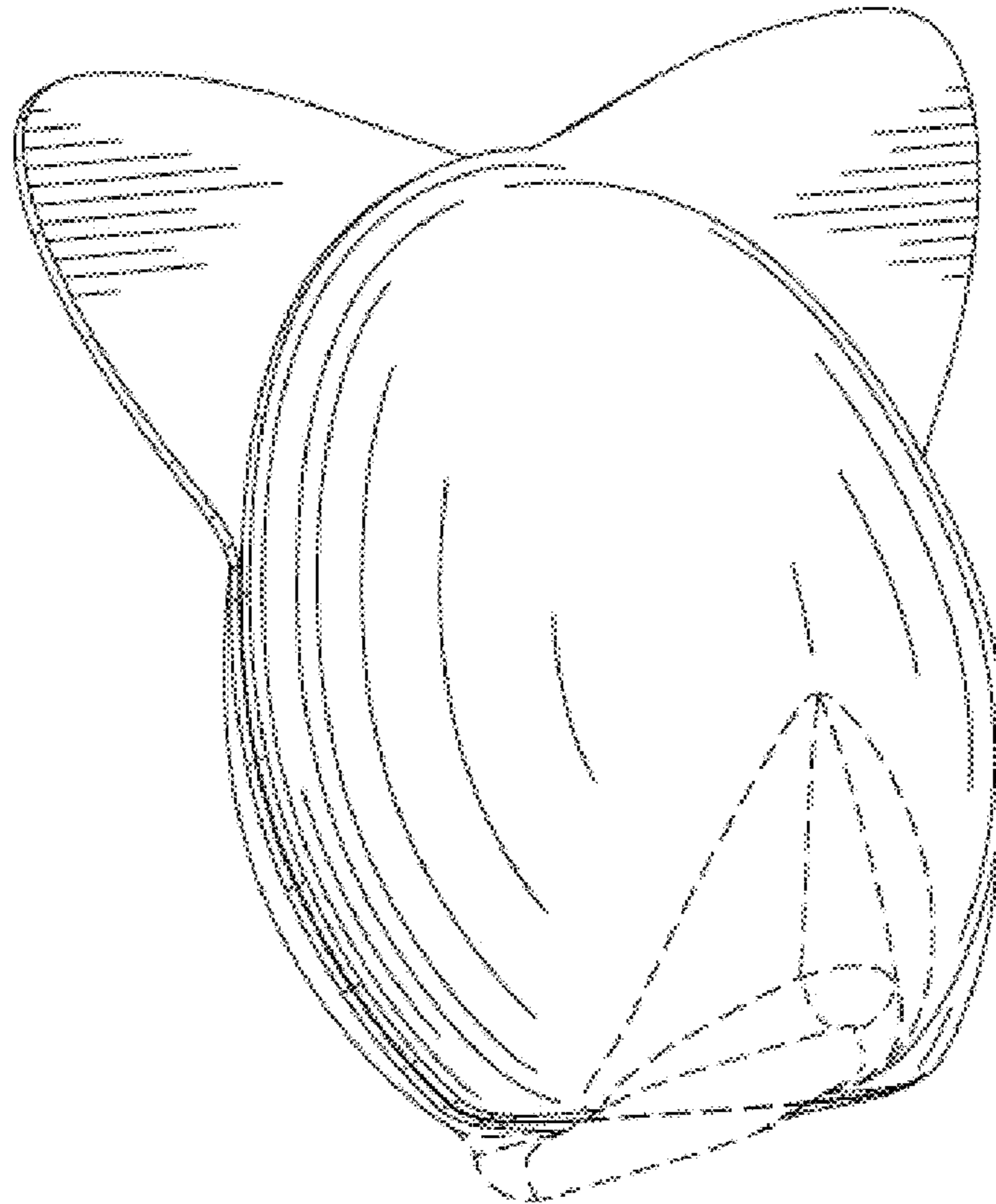

FIG. 10

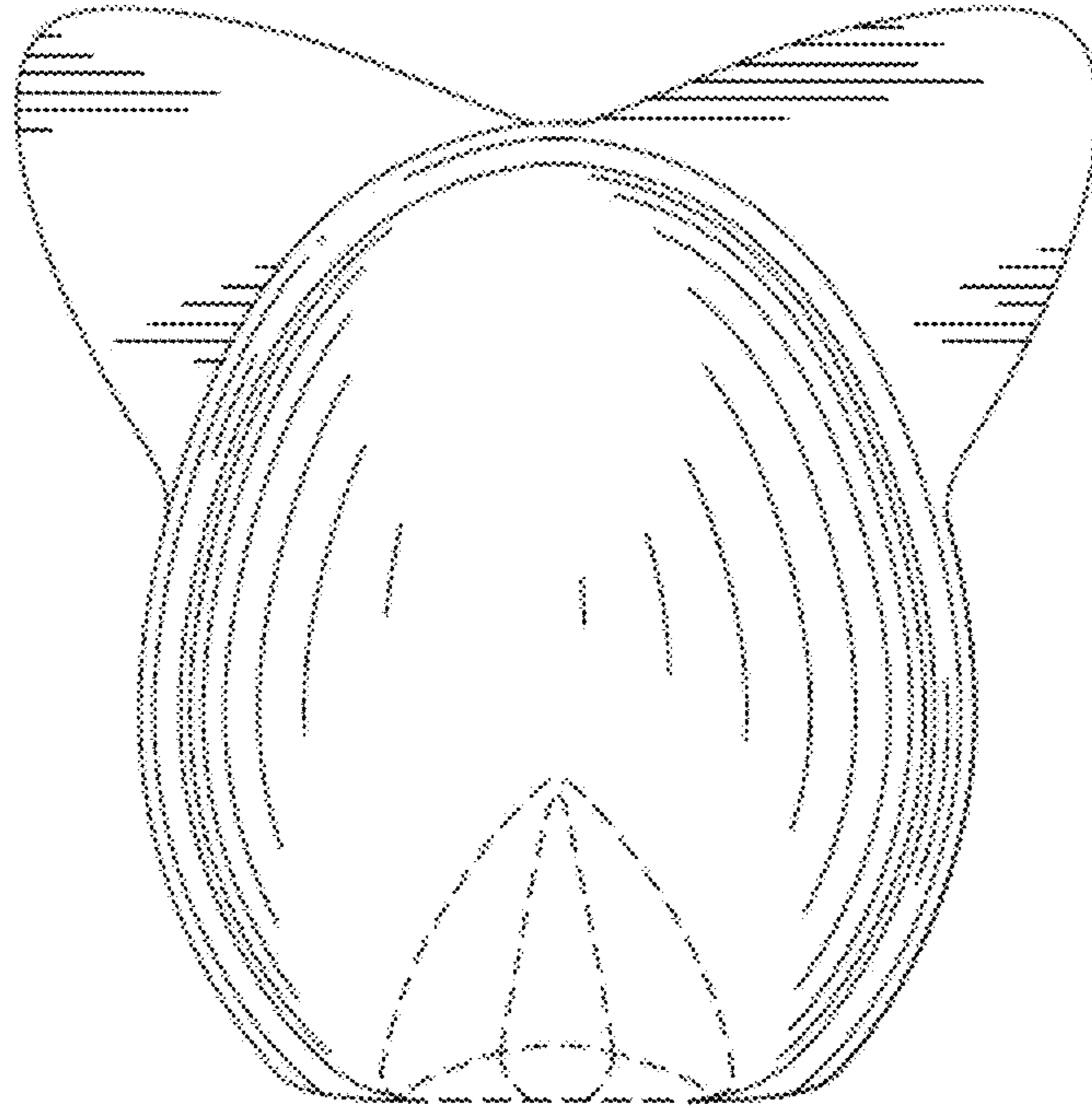

FIG. 11

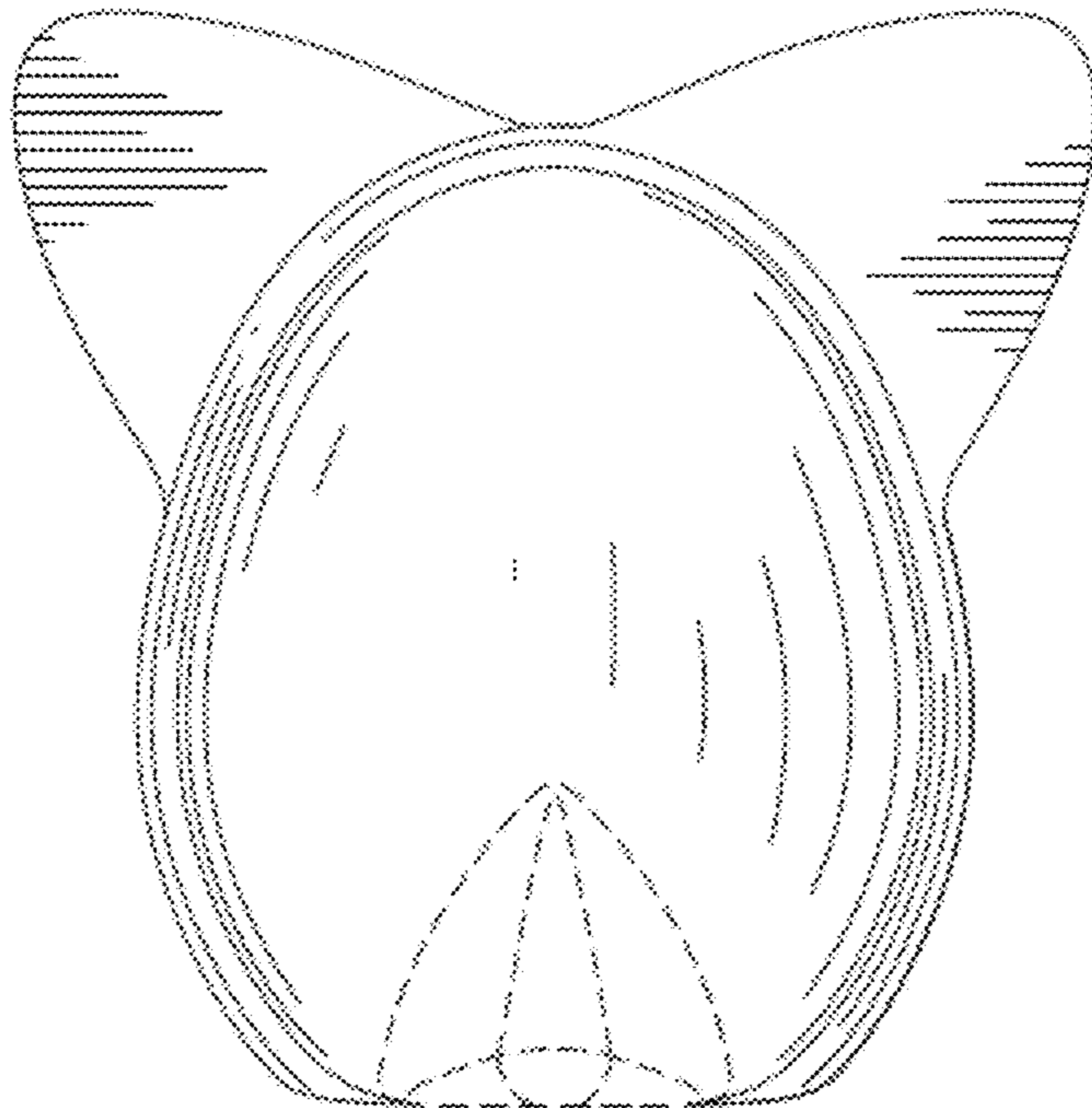

FIG. 12

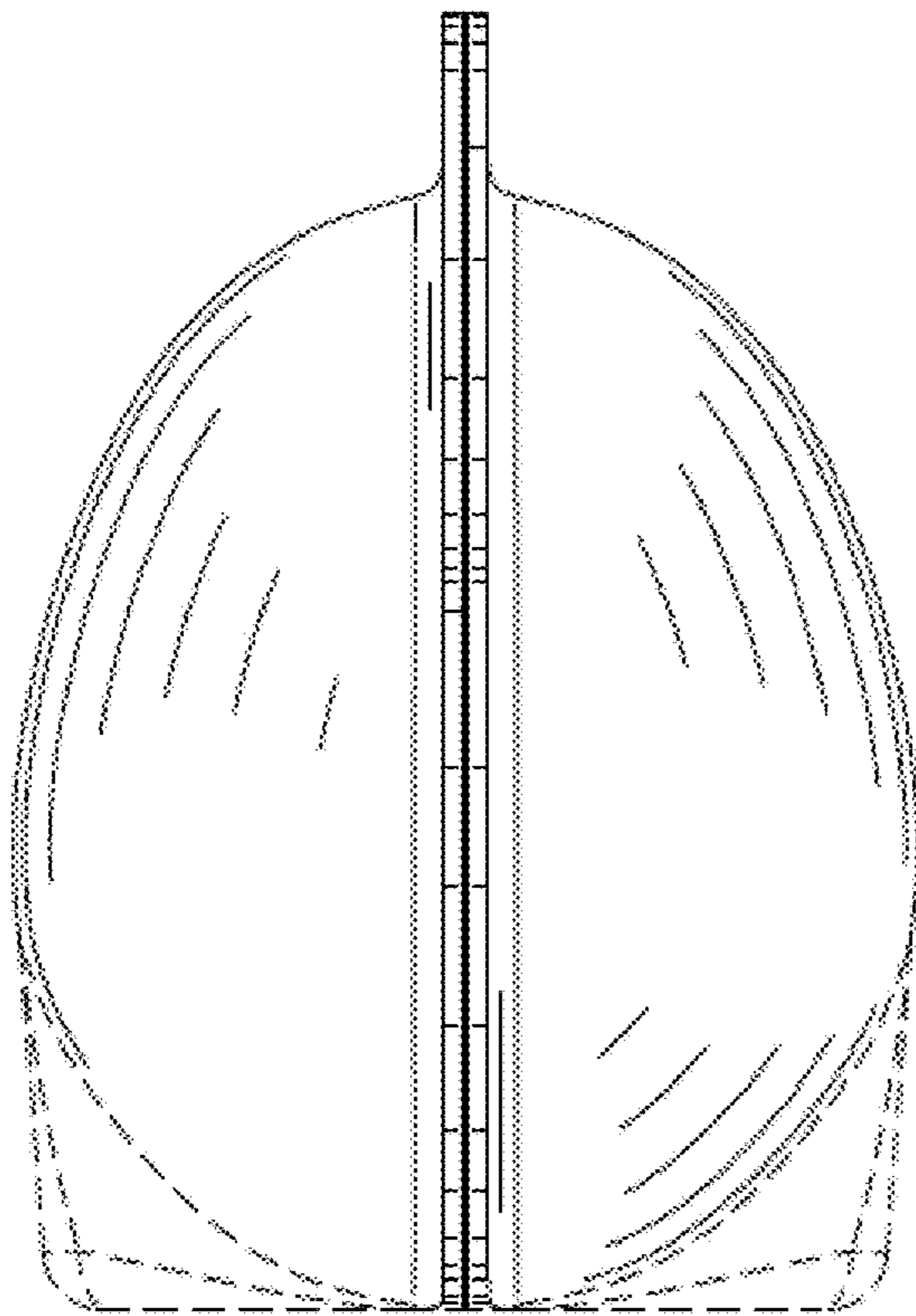

FIG. 13

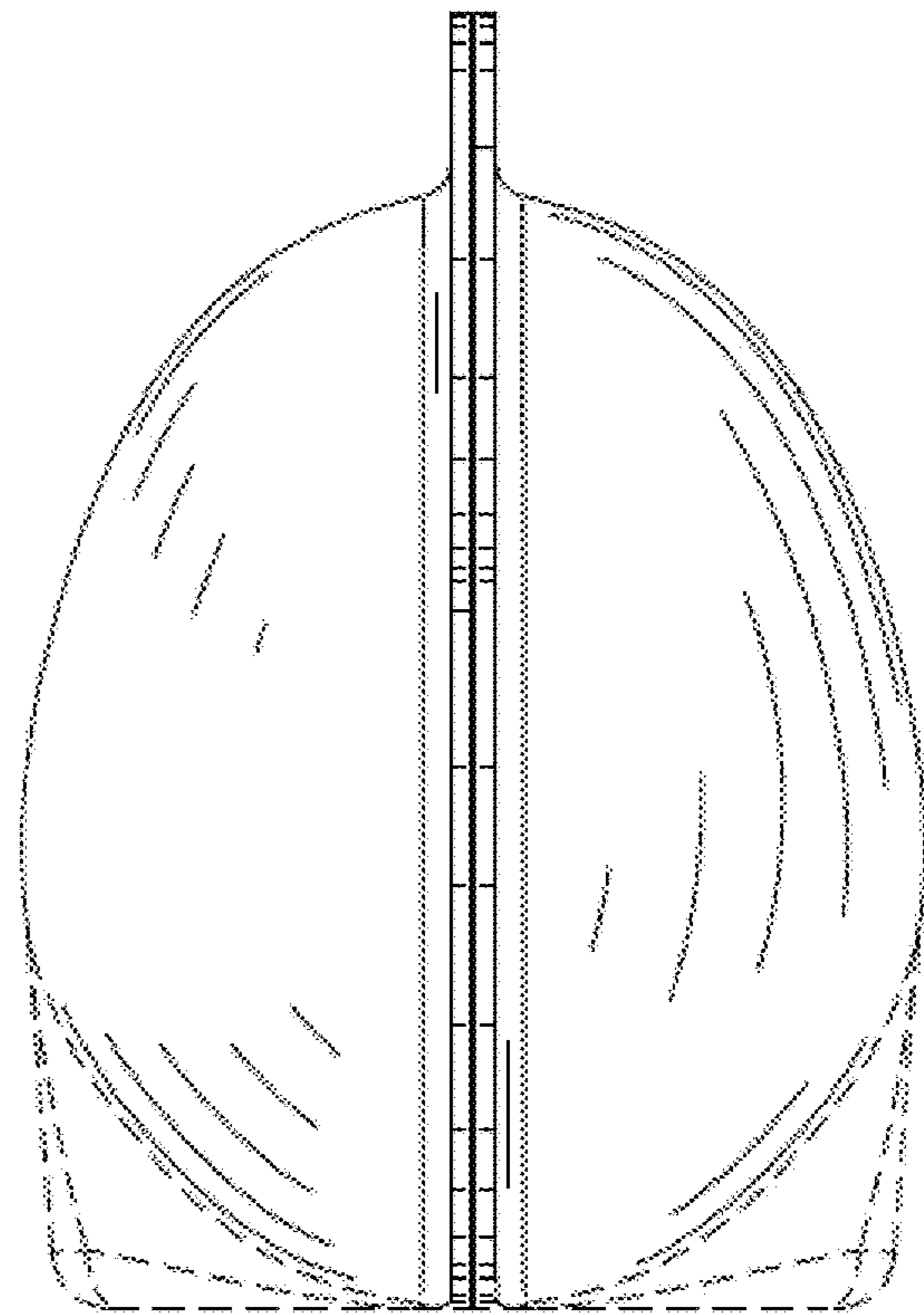

FIG. 14

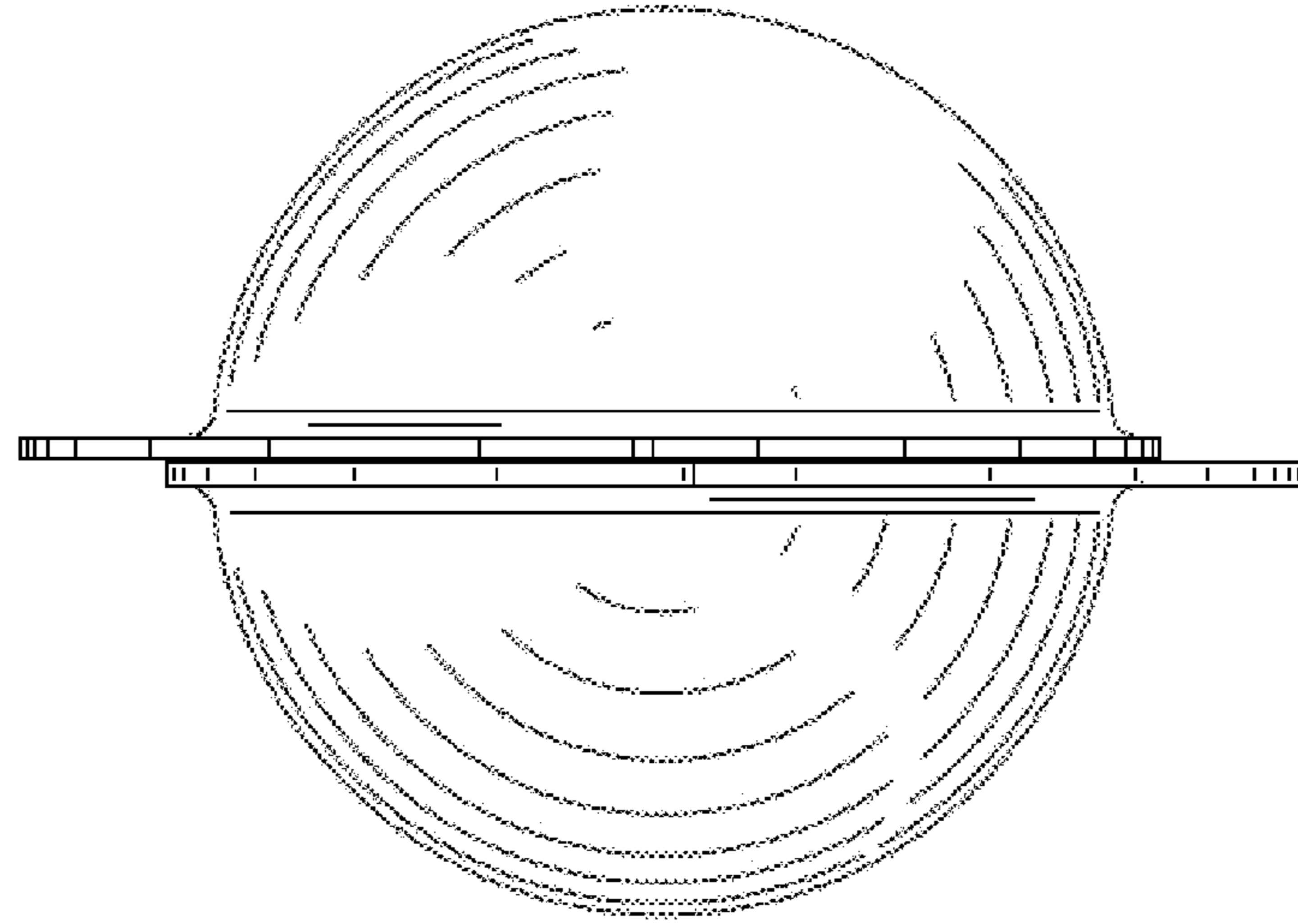

FIG. 15

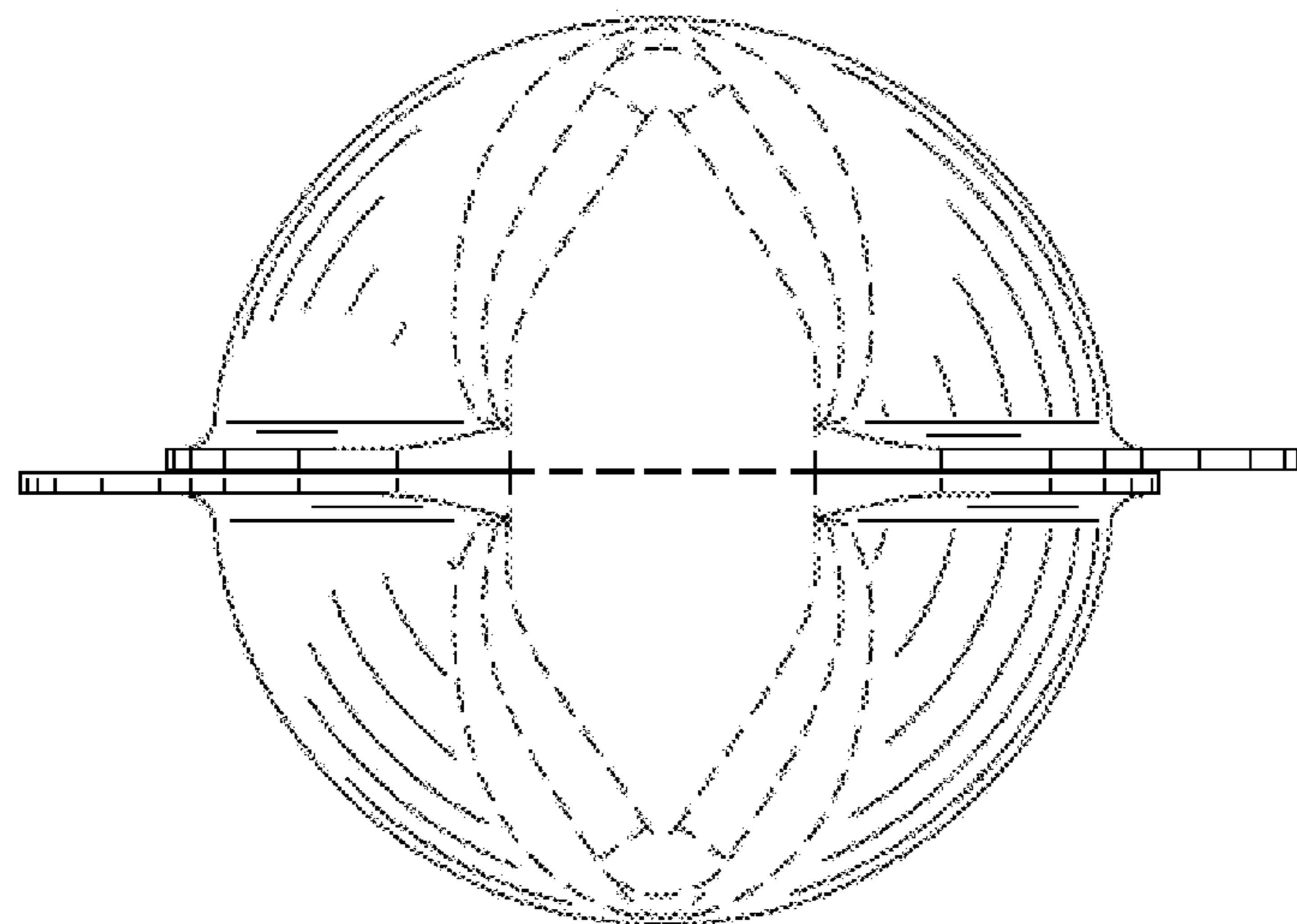

FIG. 16



FIG. 17

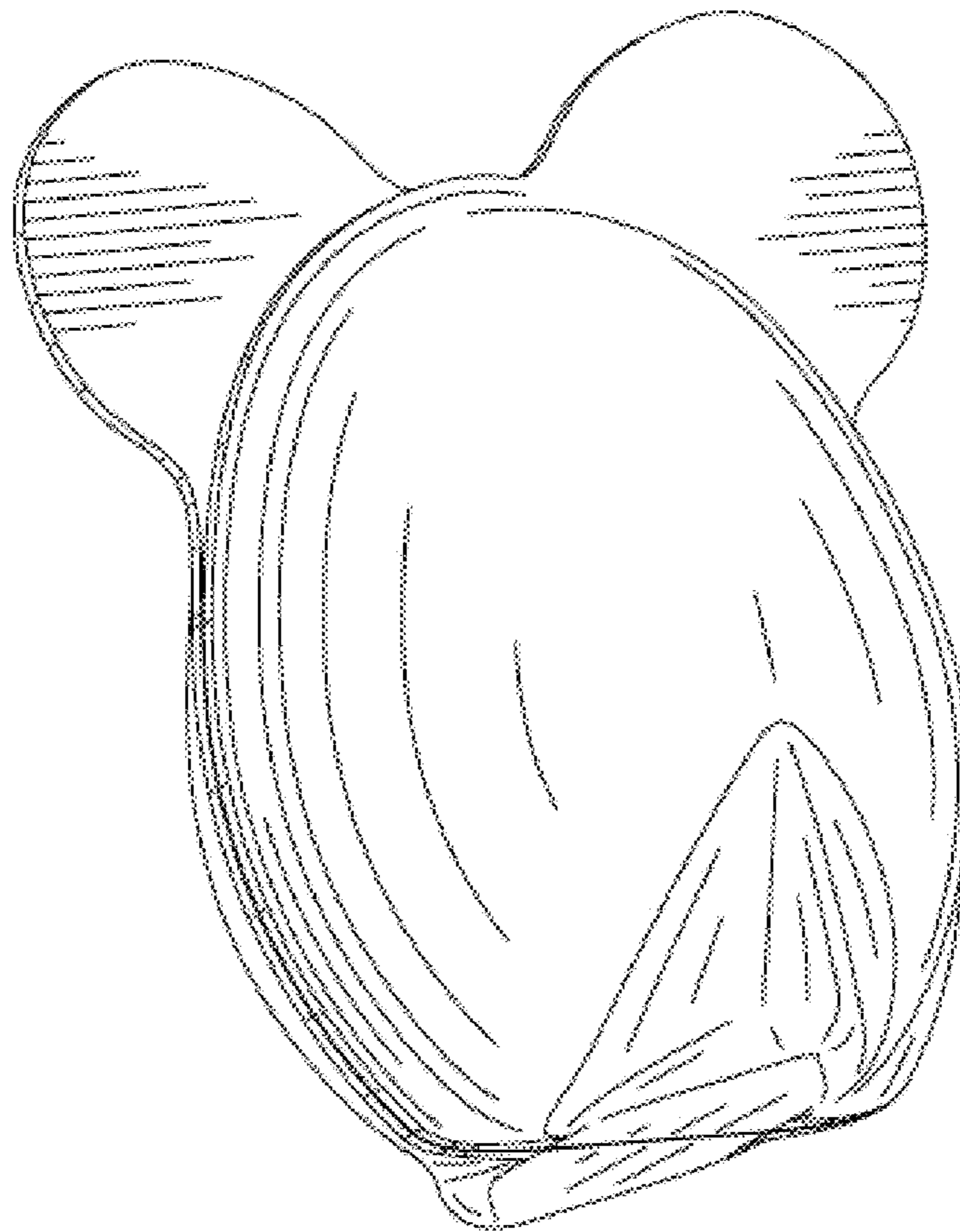

FIG. 18

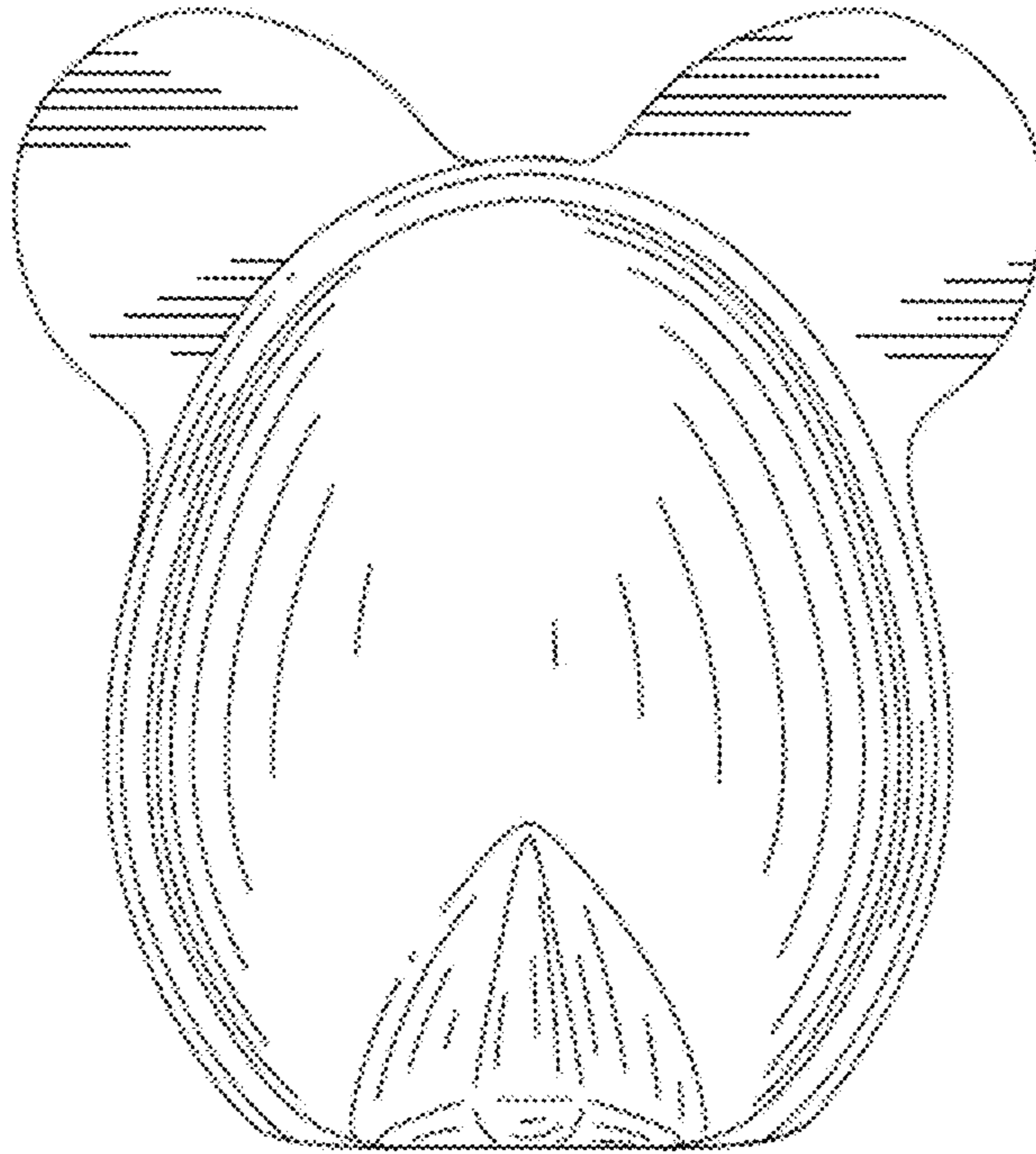

FIG. 19

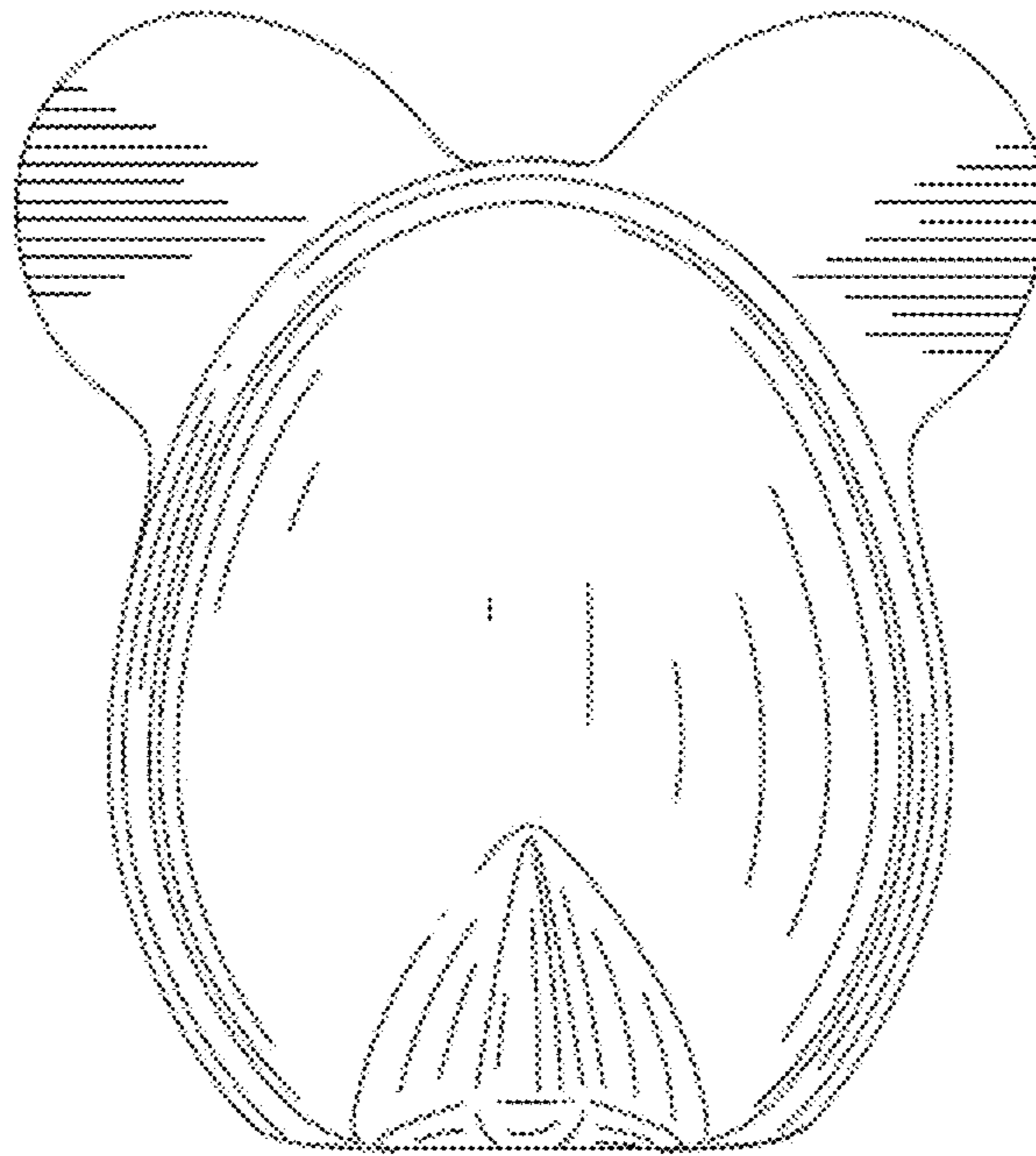

FIG. 20

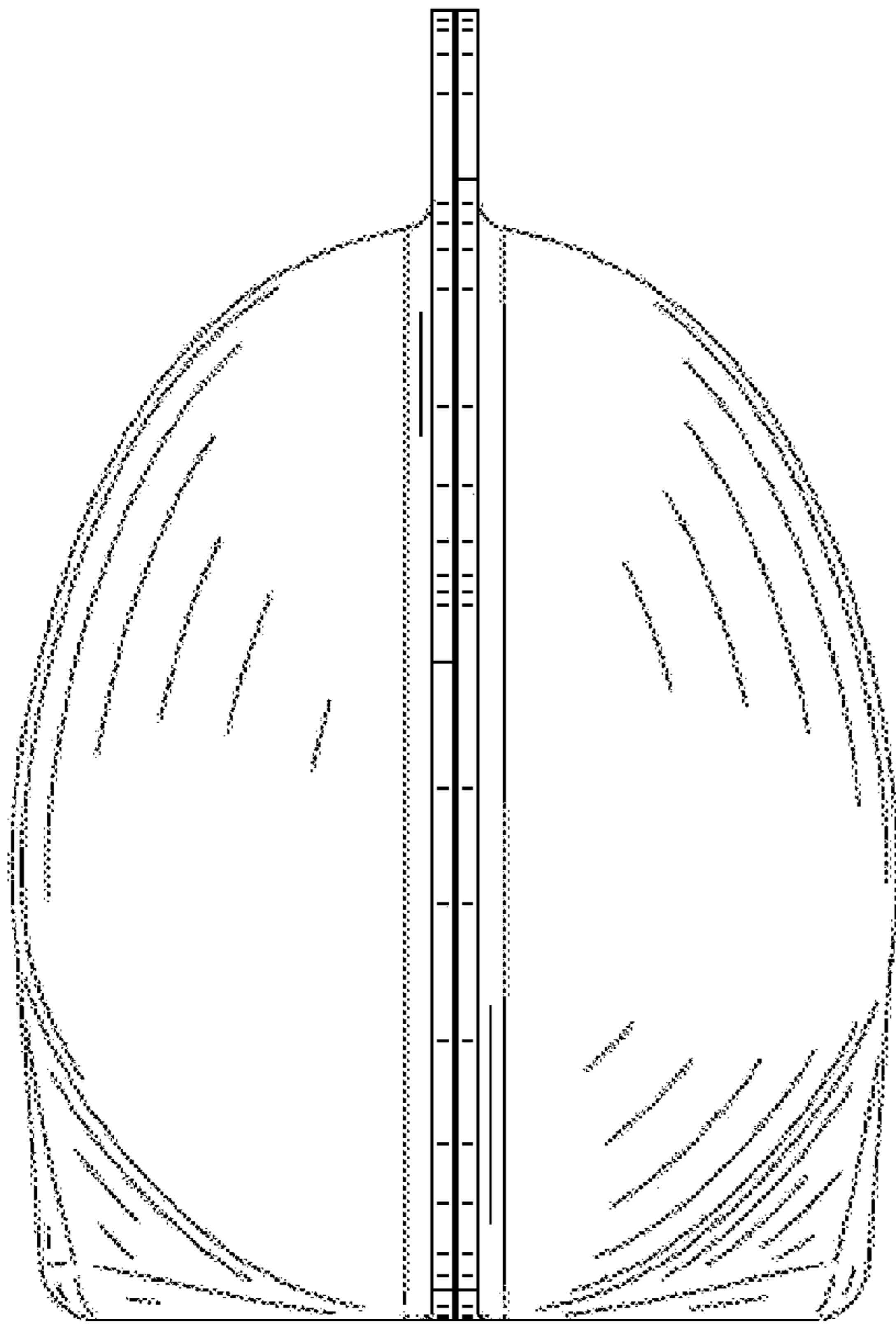

FIG. 21

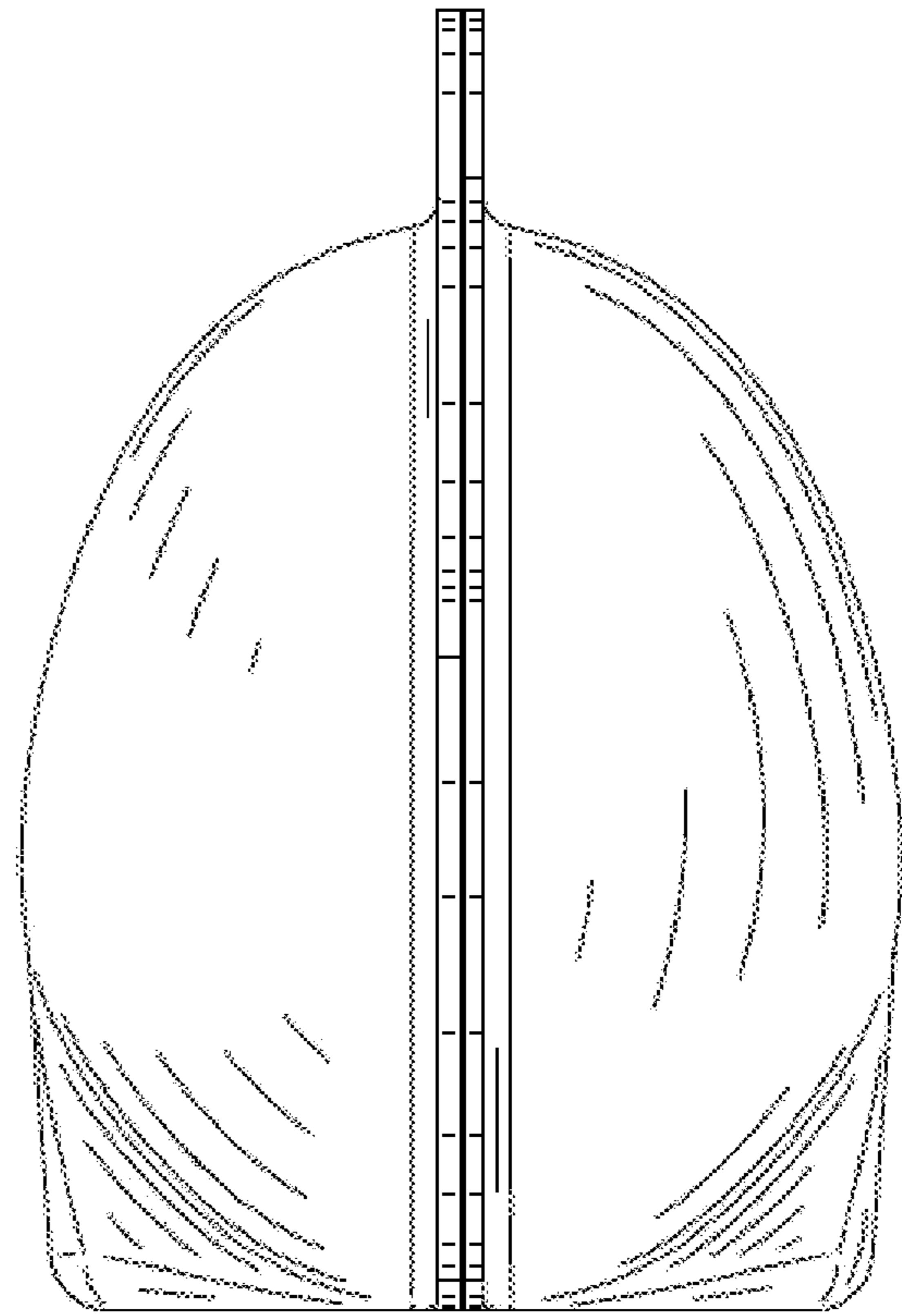

FIG. 22

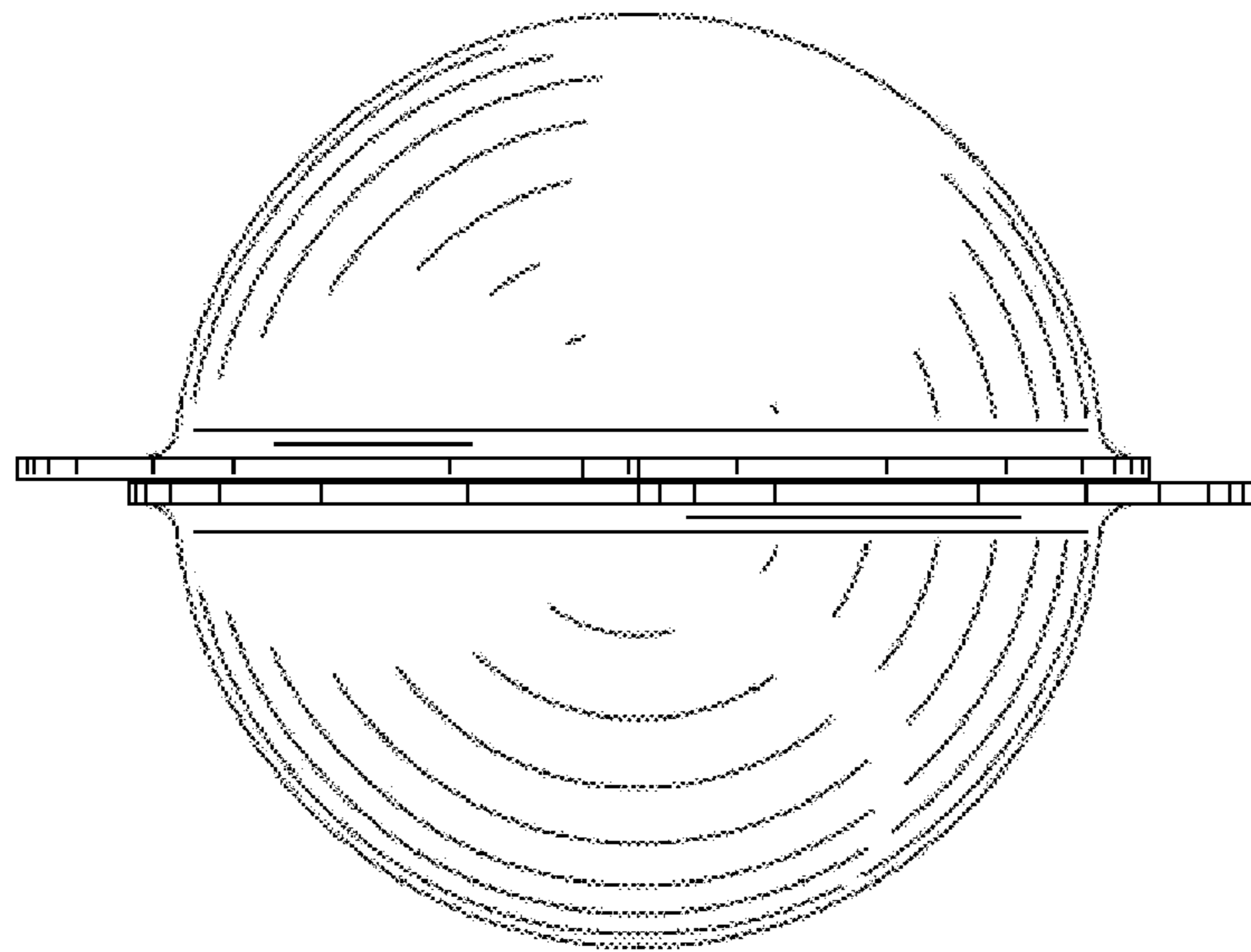

FIG. 23

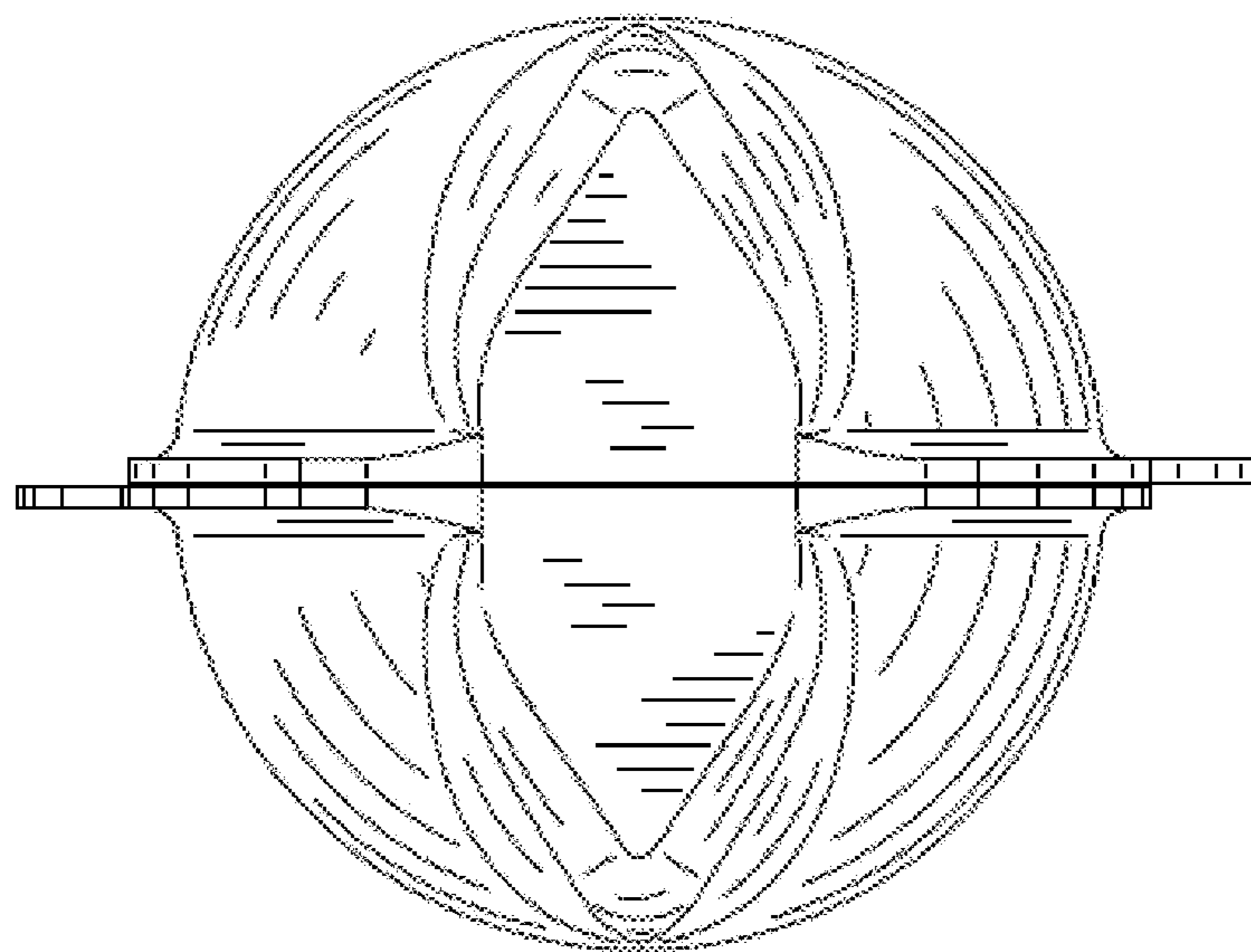

FIG. 24



FIG. 25

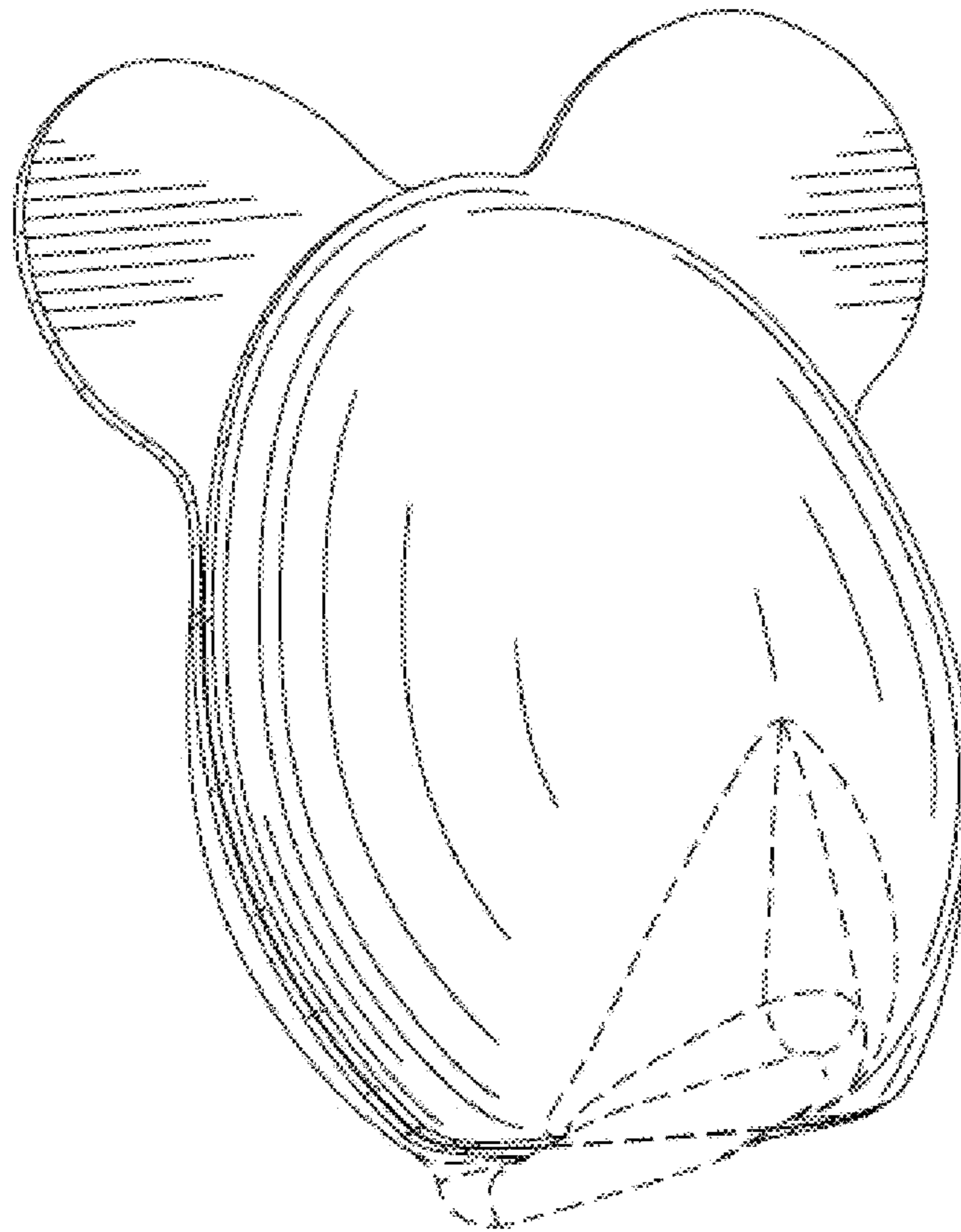

FIG. 26

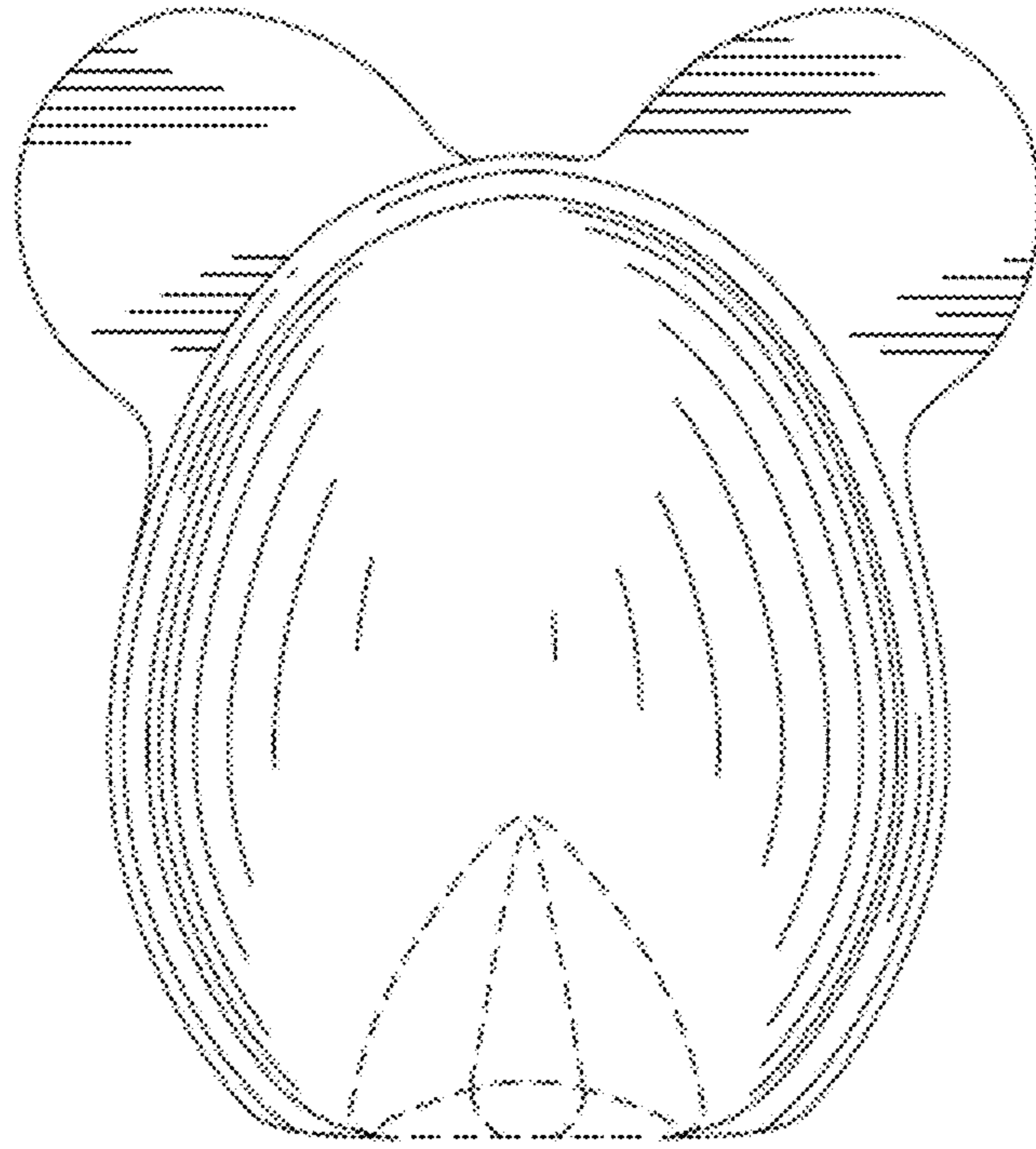

FIG. 27

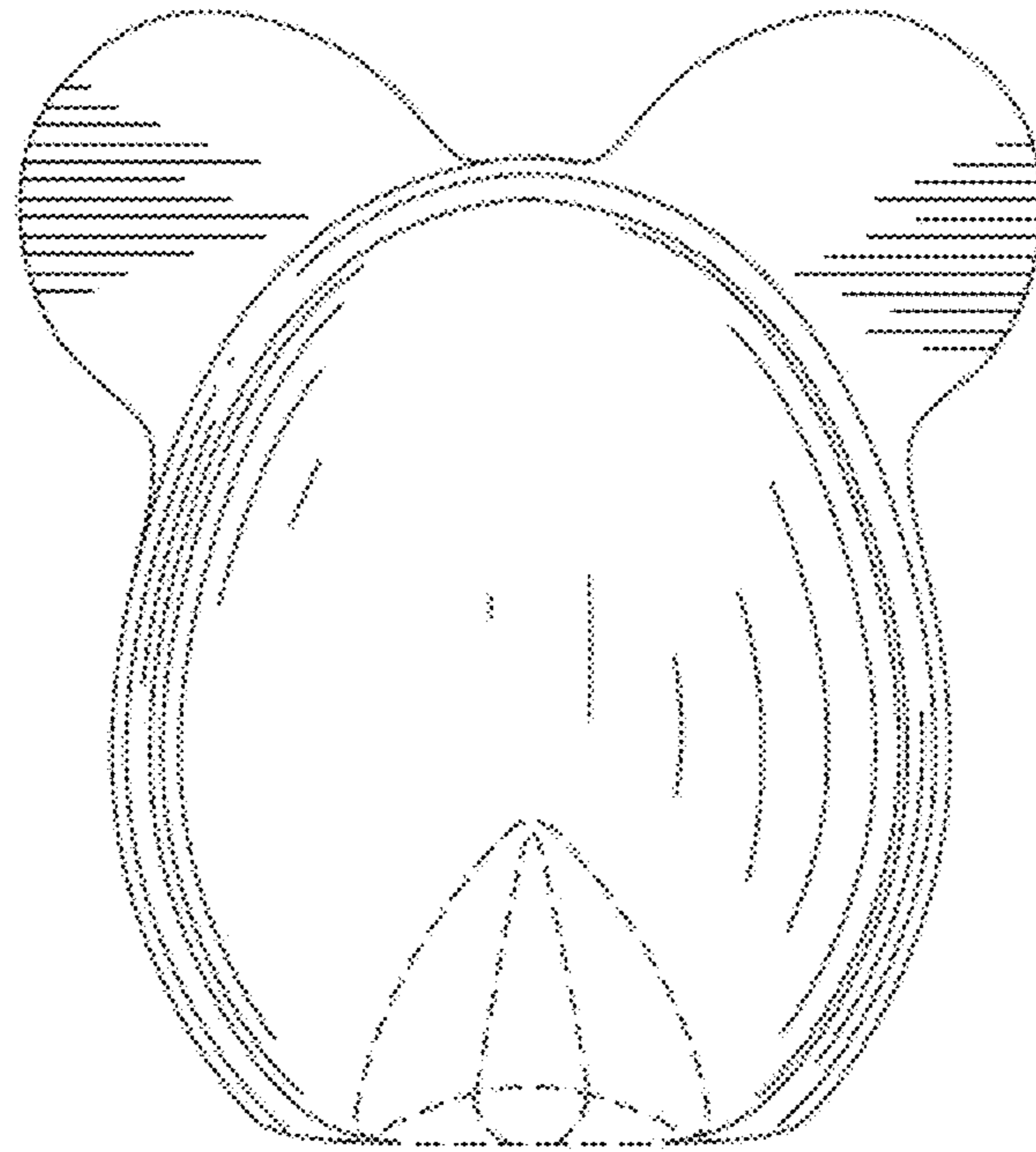

FIG. 28

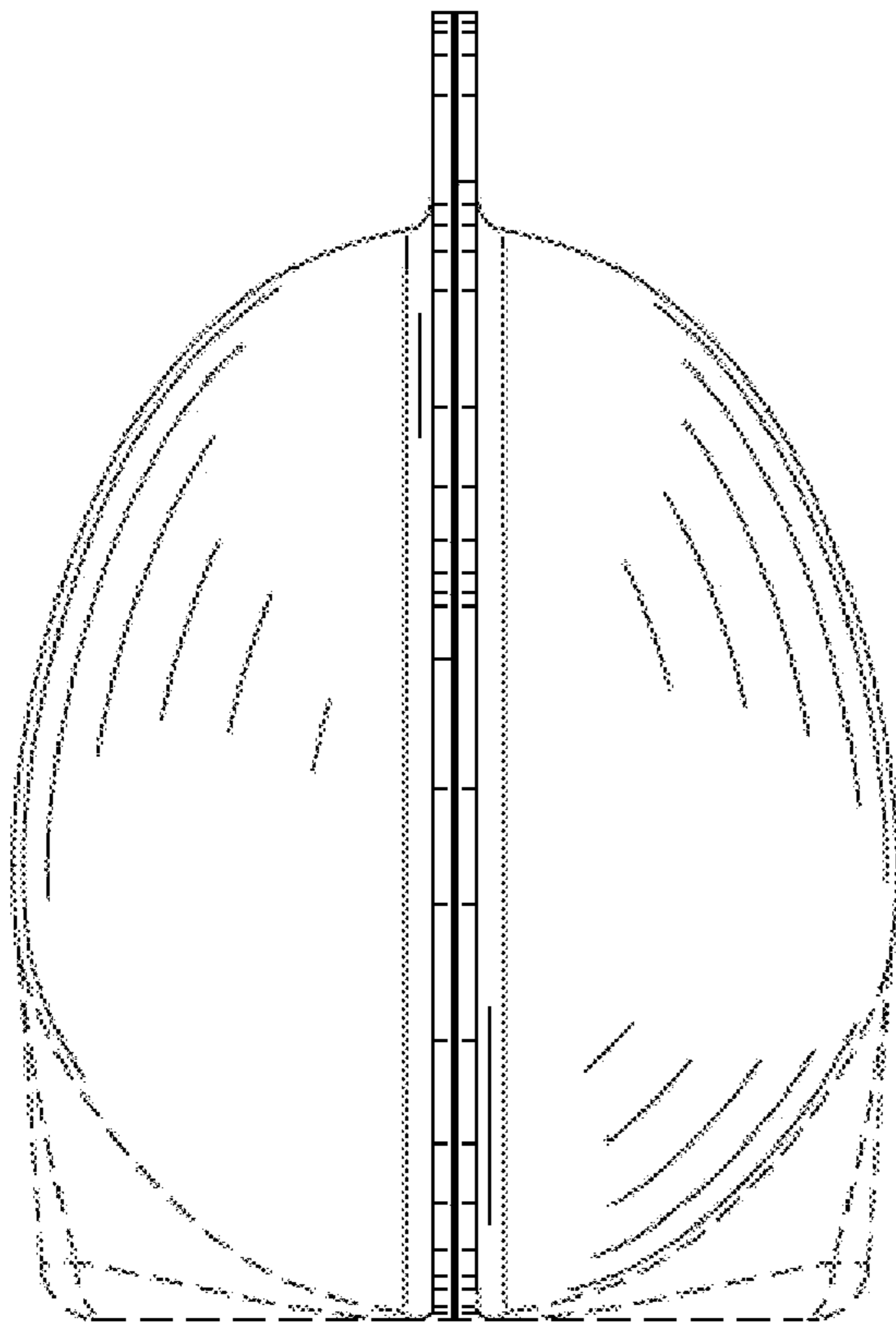

FIG. 29

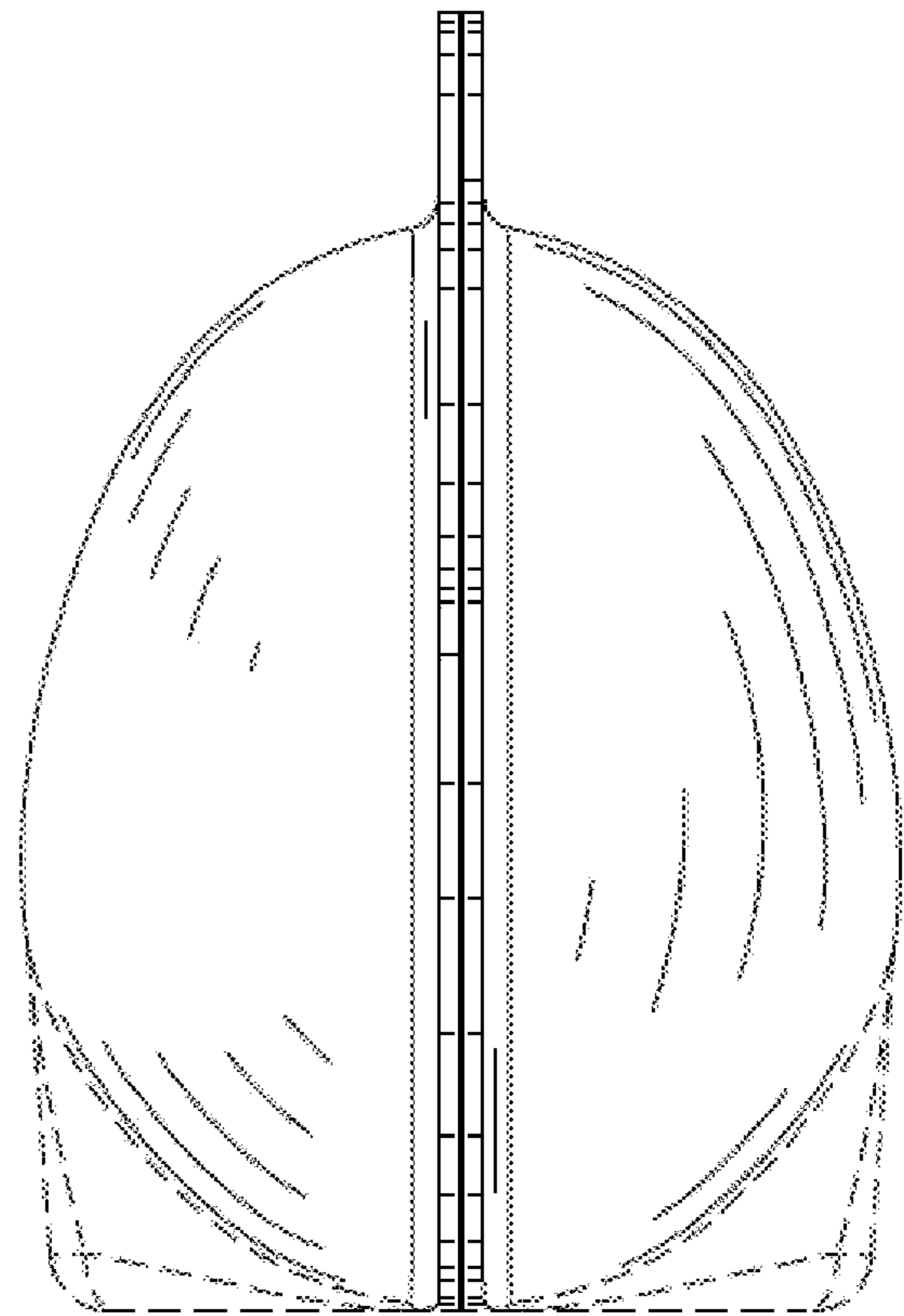

FIG. 30

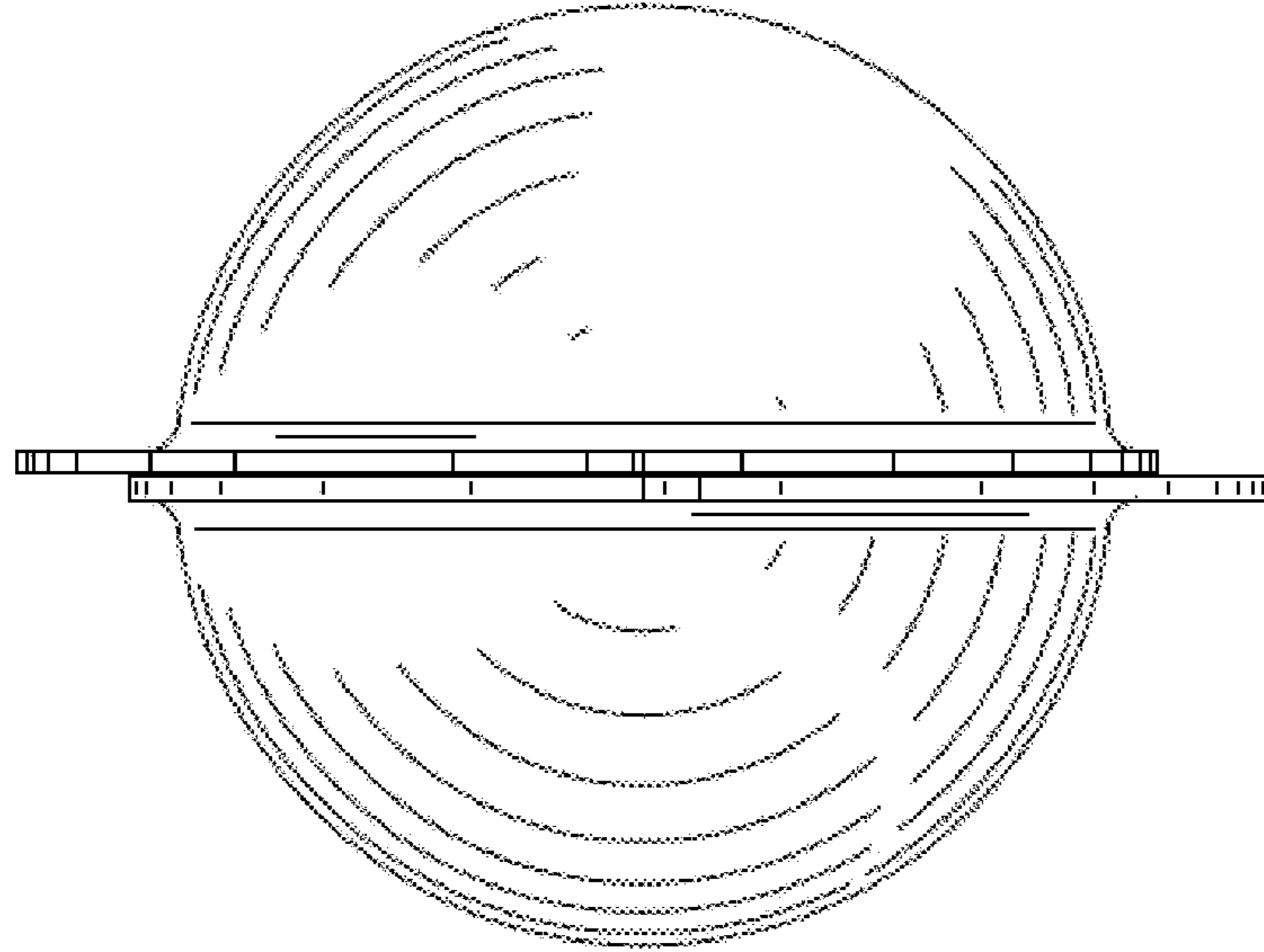

FIG. 31

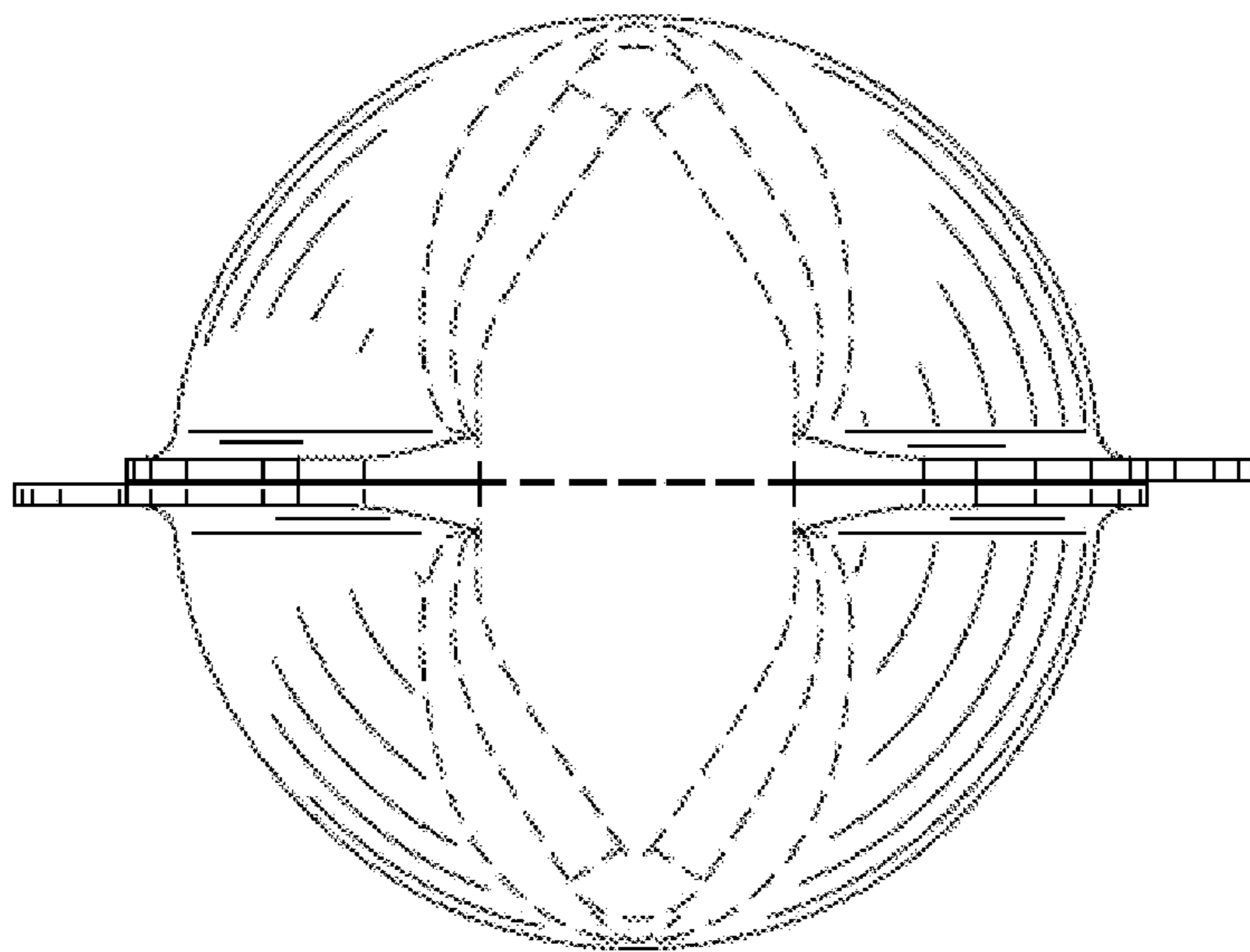

FIG. 32

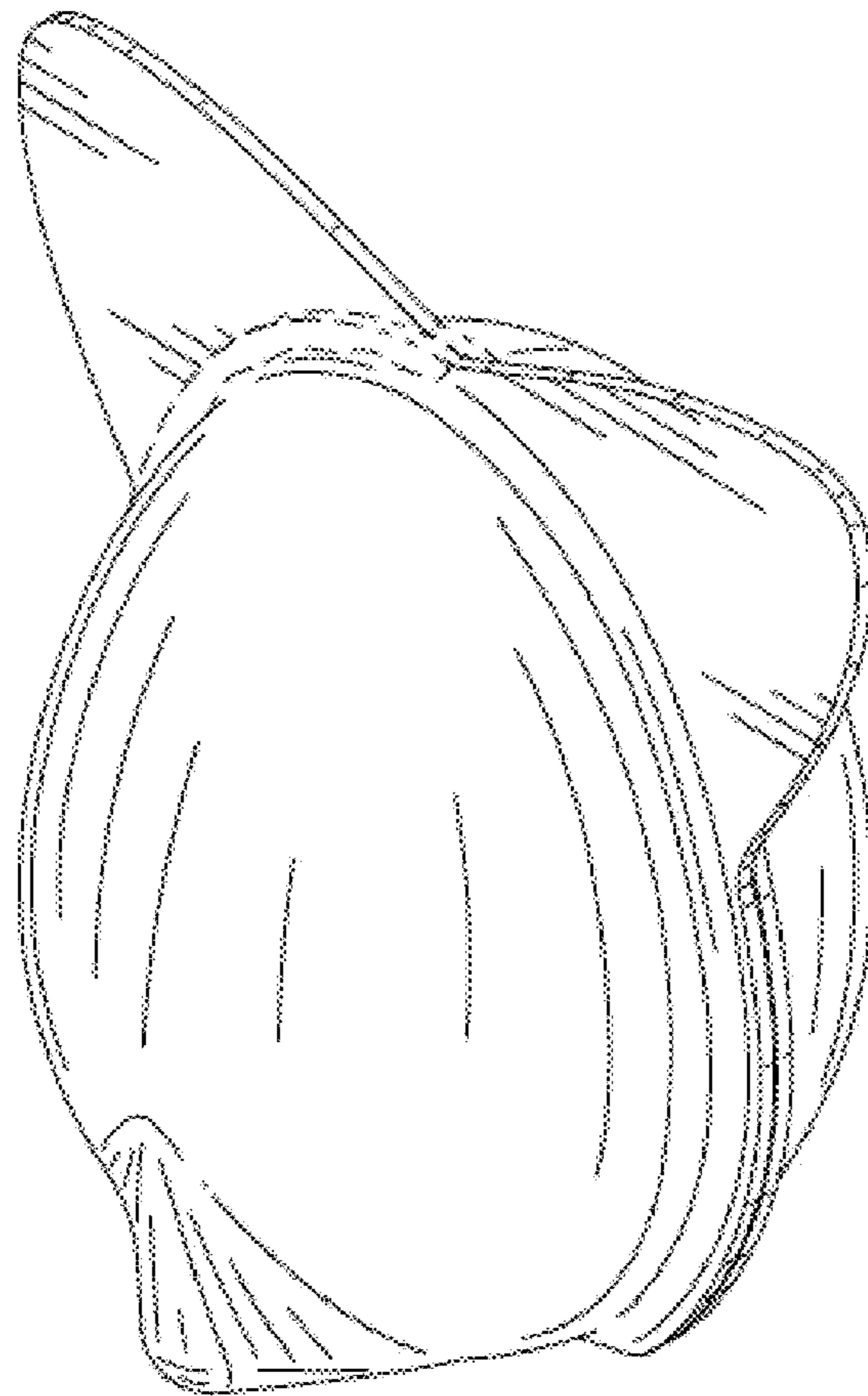

FIG. 33

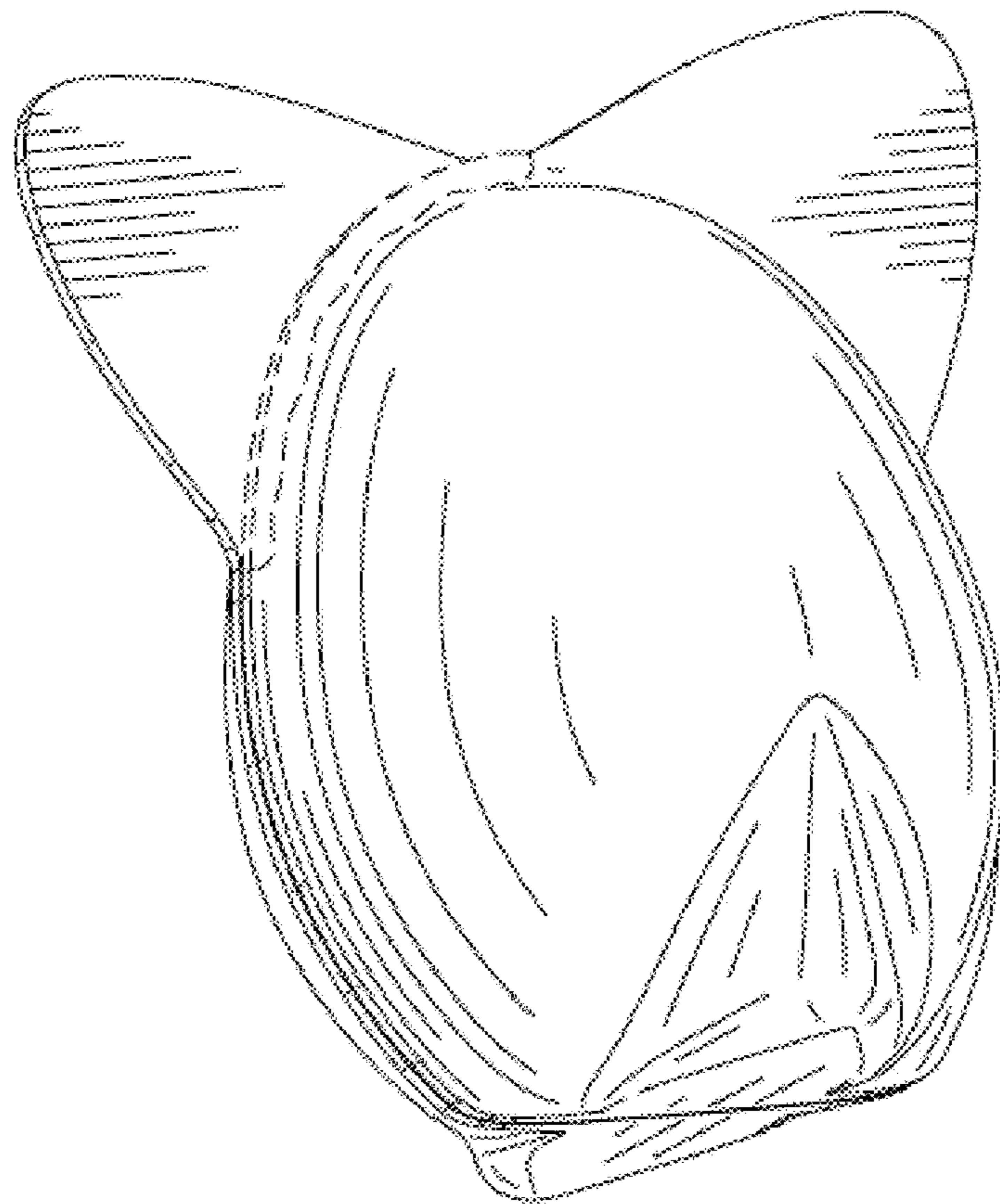

FIG. 34

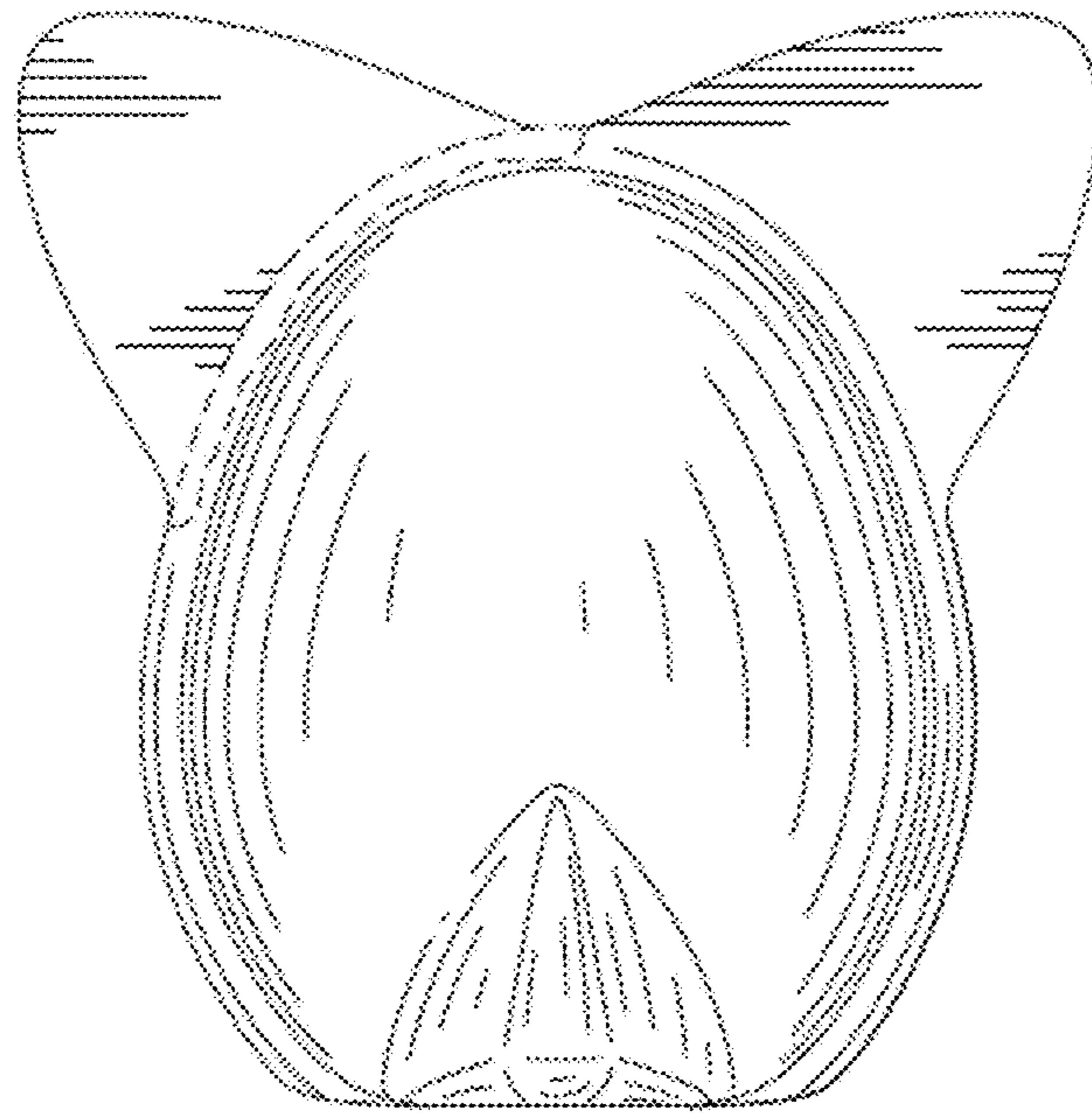

FIG. 35

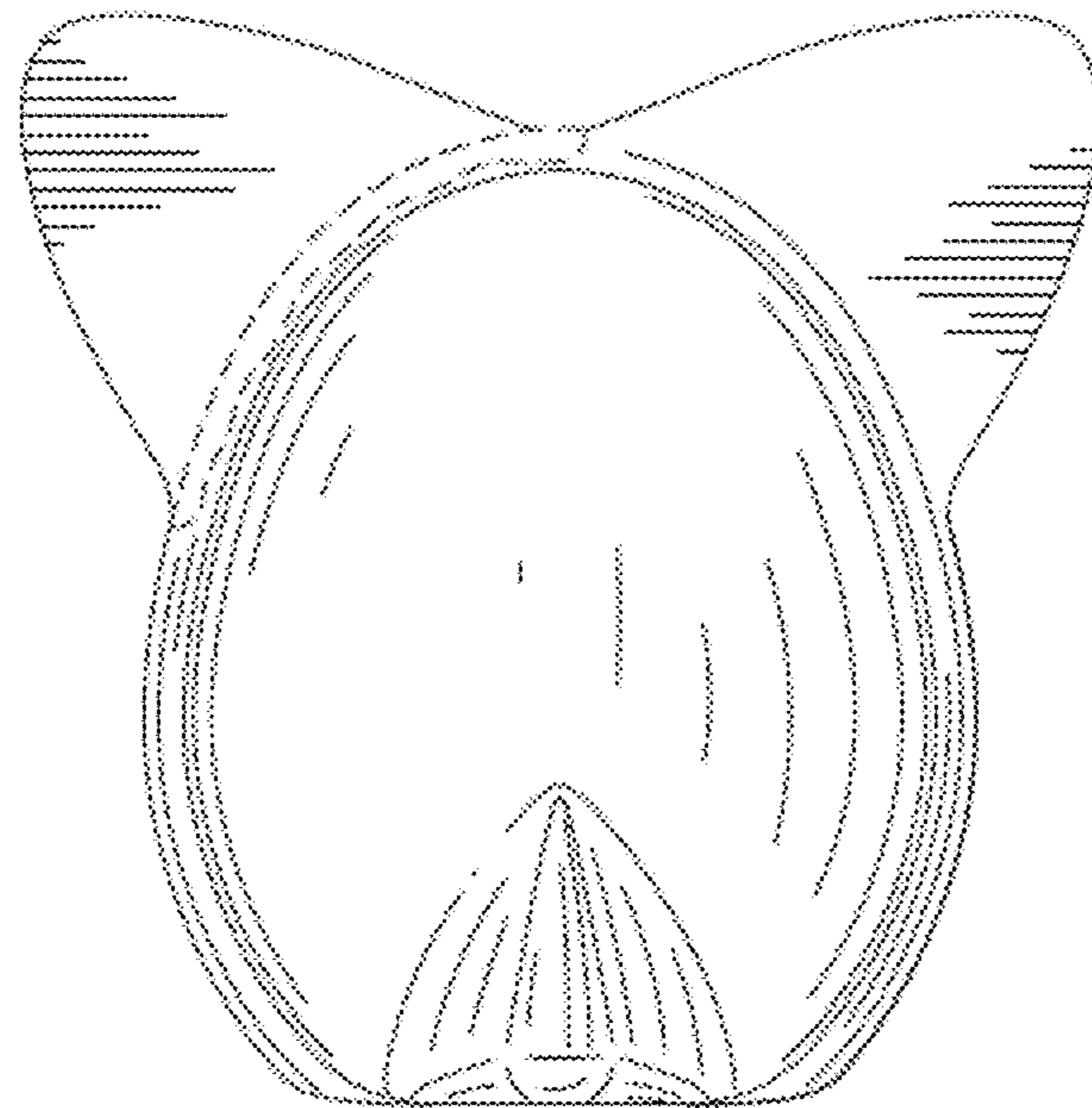

FIG. 36

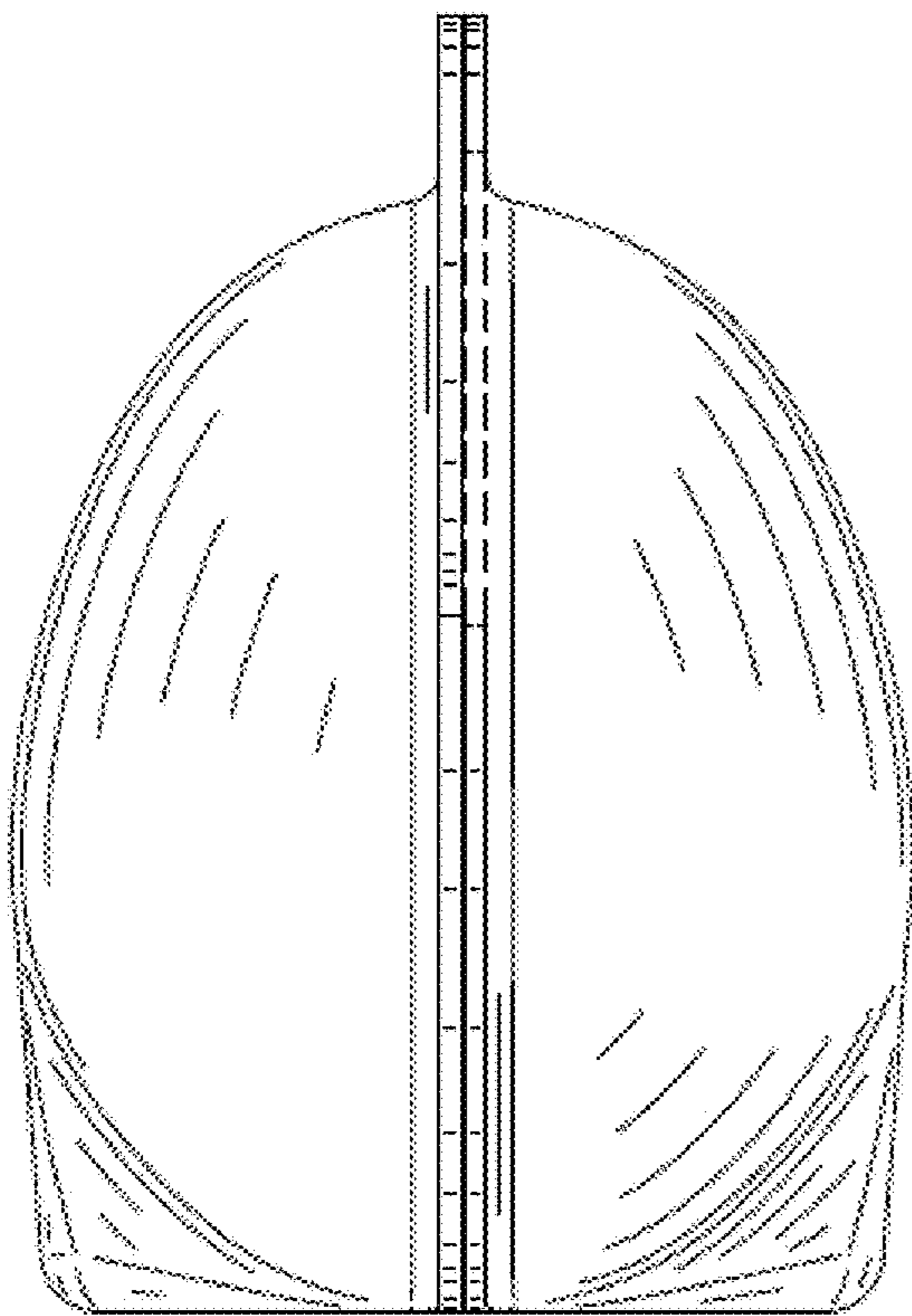

FIG. 37

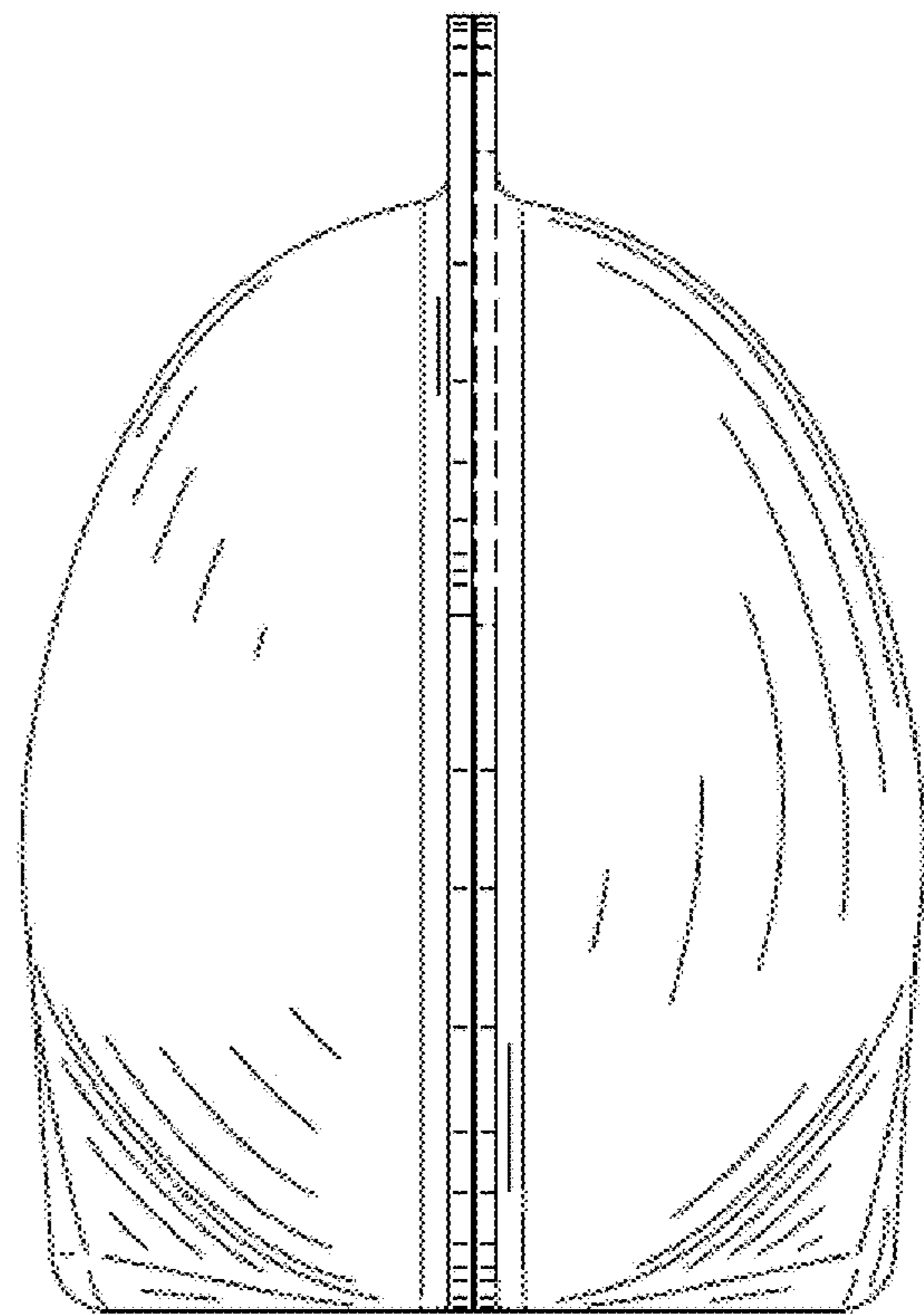

FIG. 38

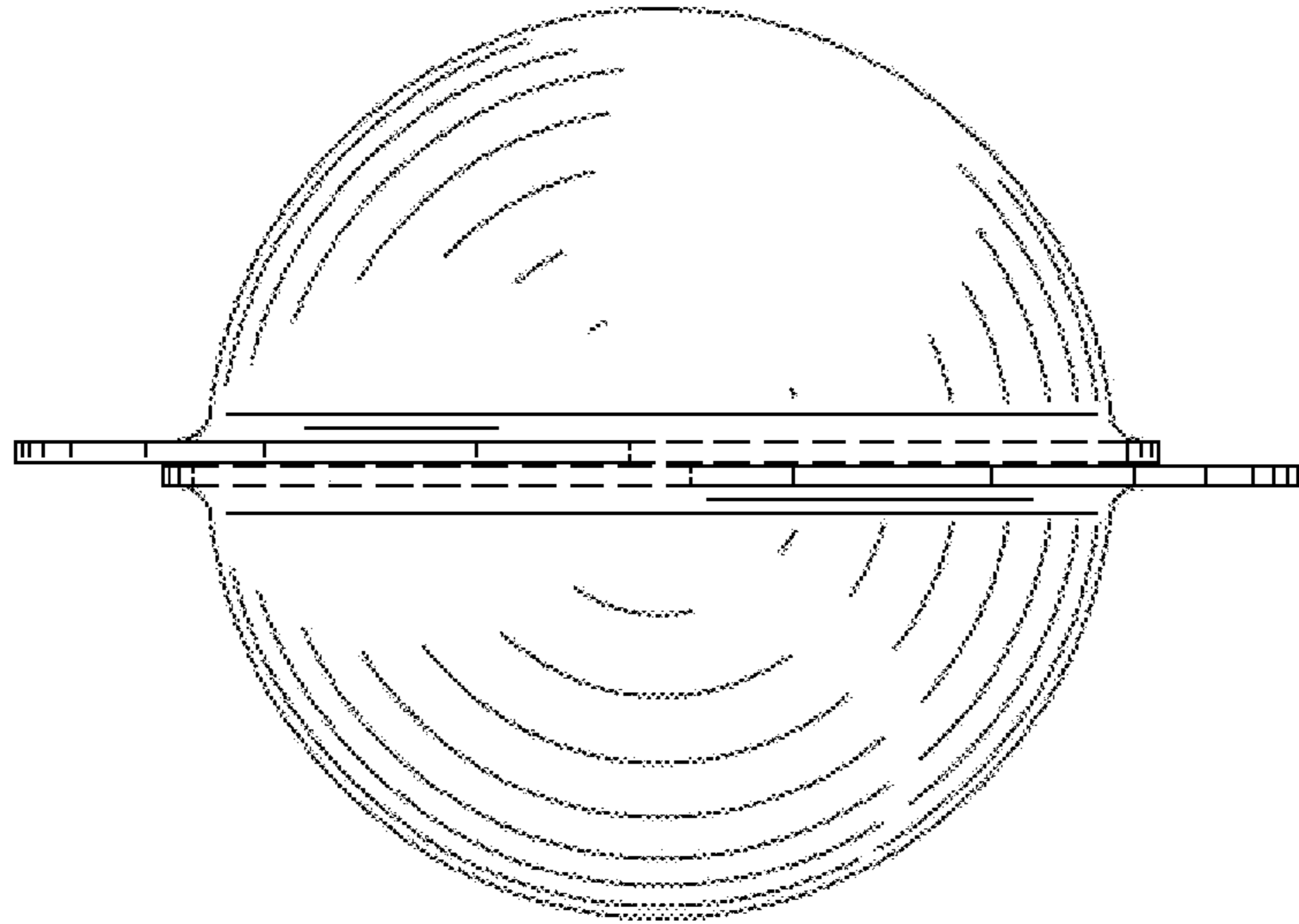

FIG. 39

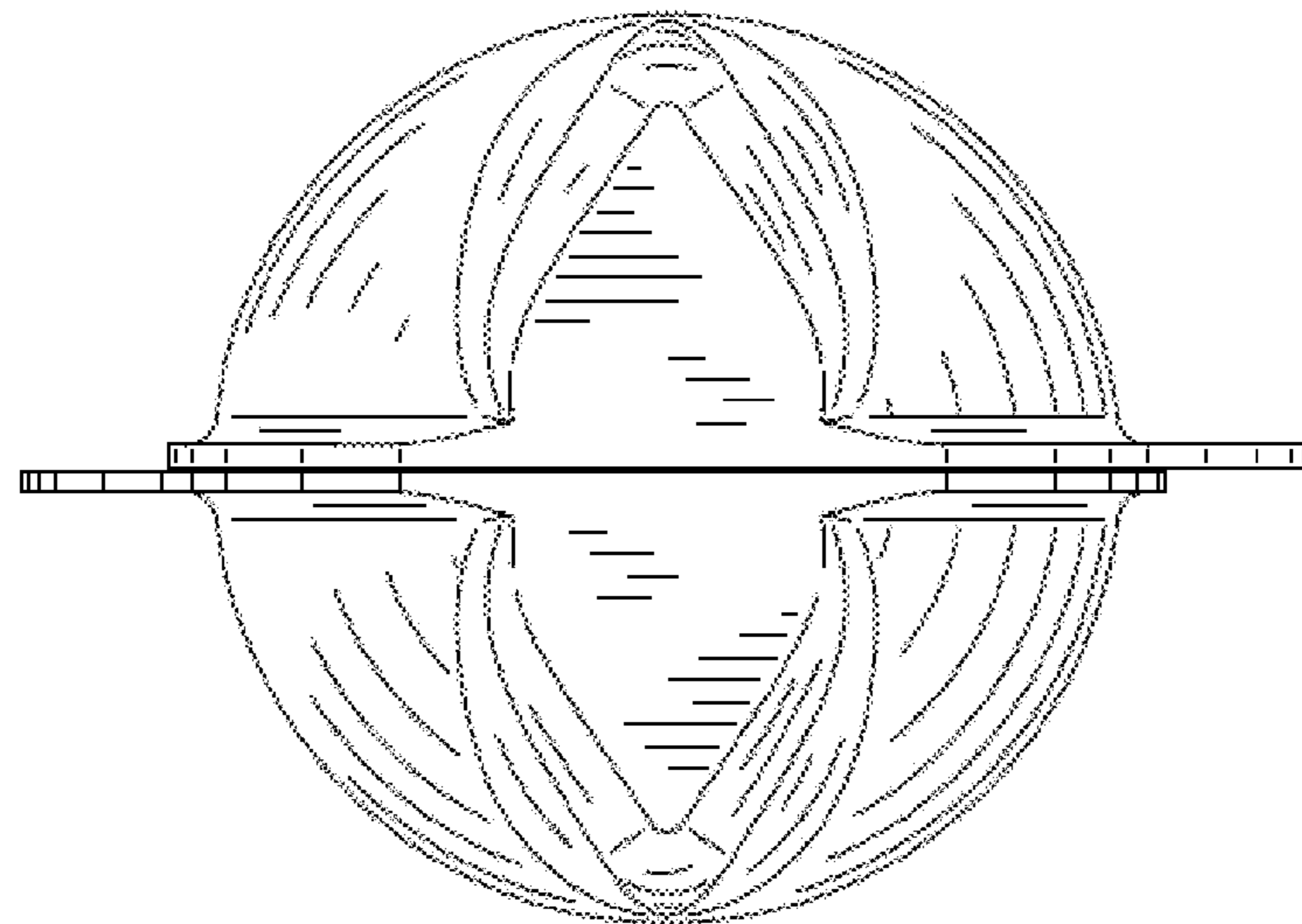

FIG. 40



FIG. 41

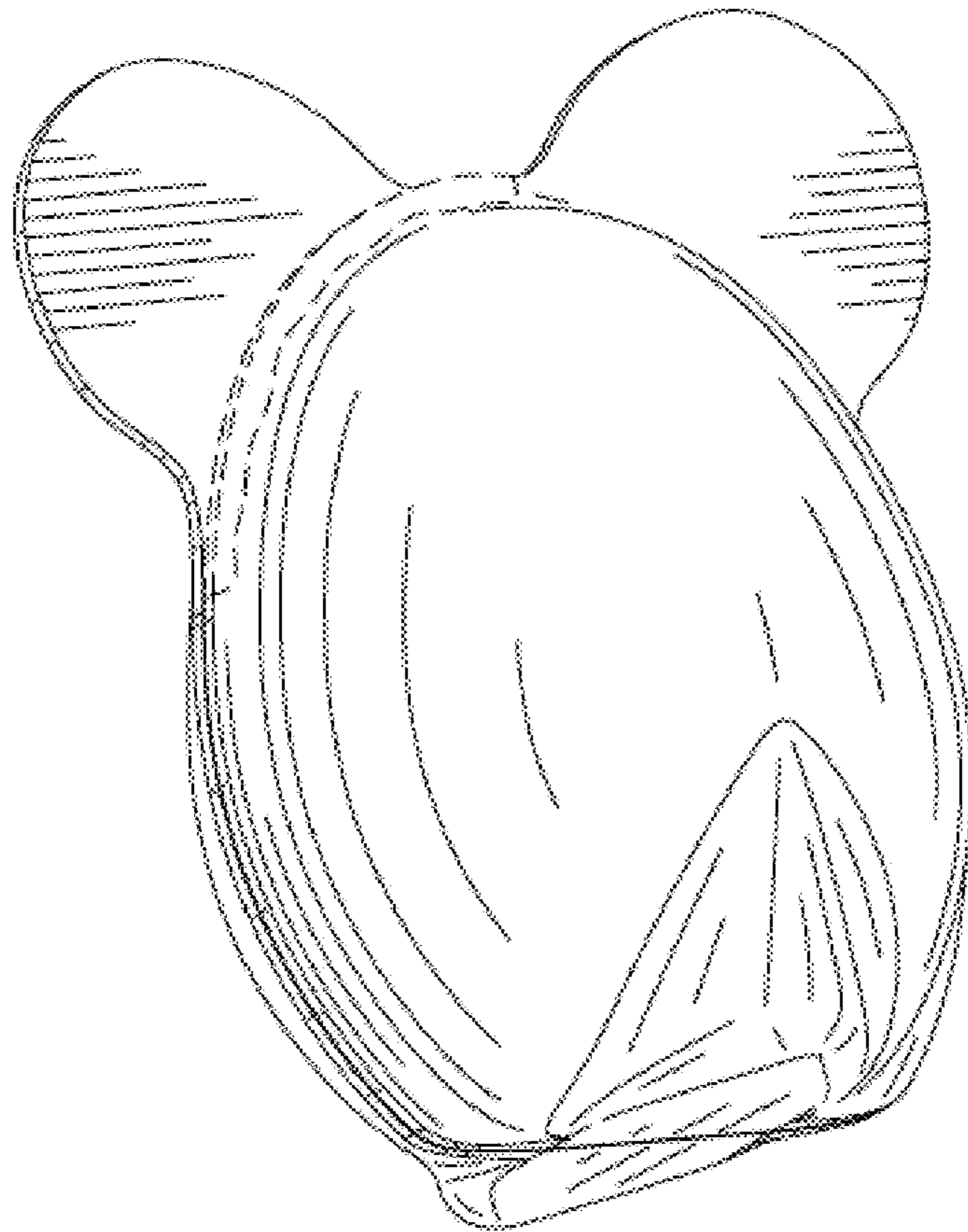

FIG. 42

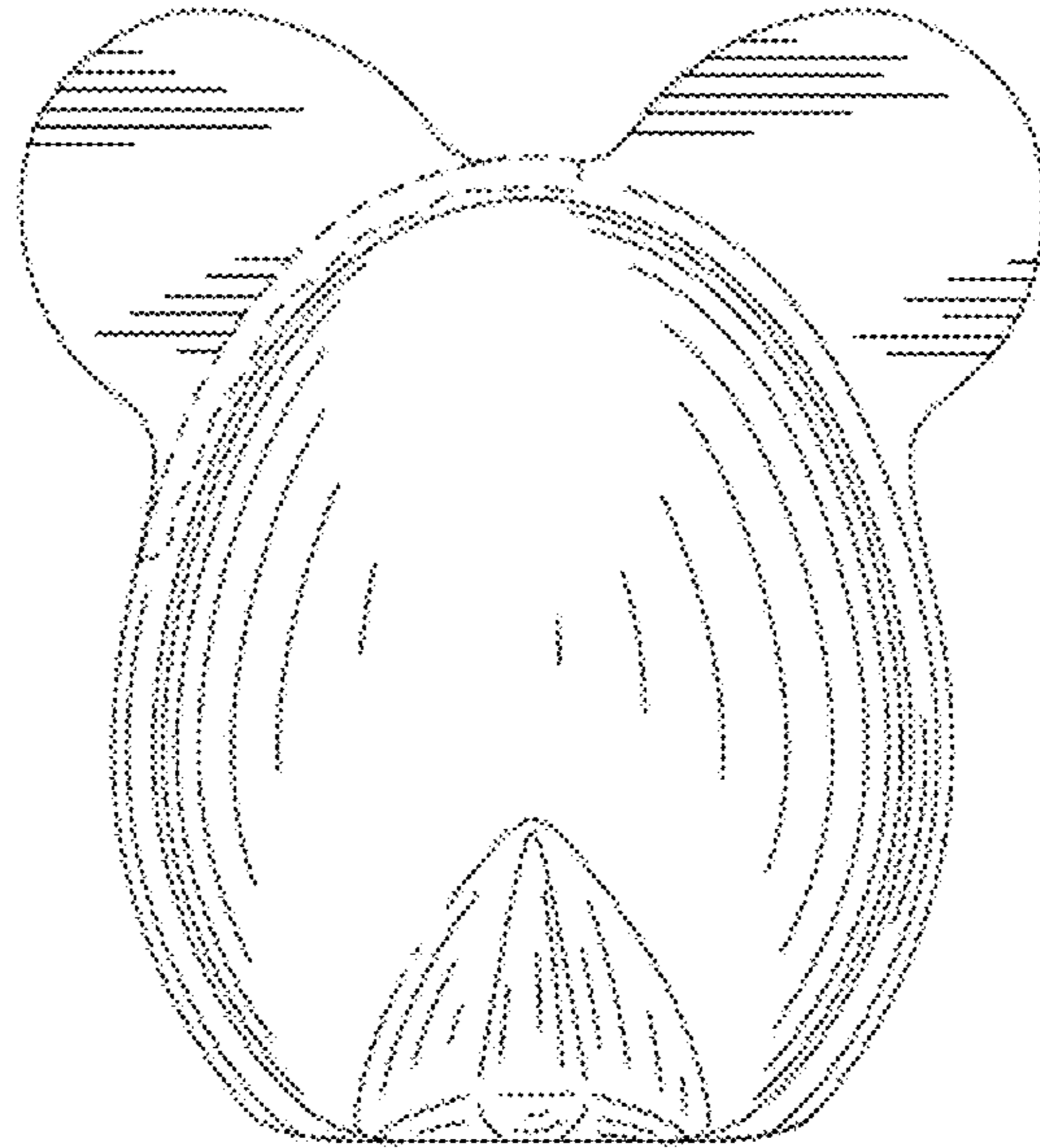

FIG. 43

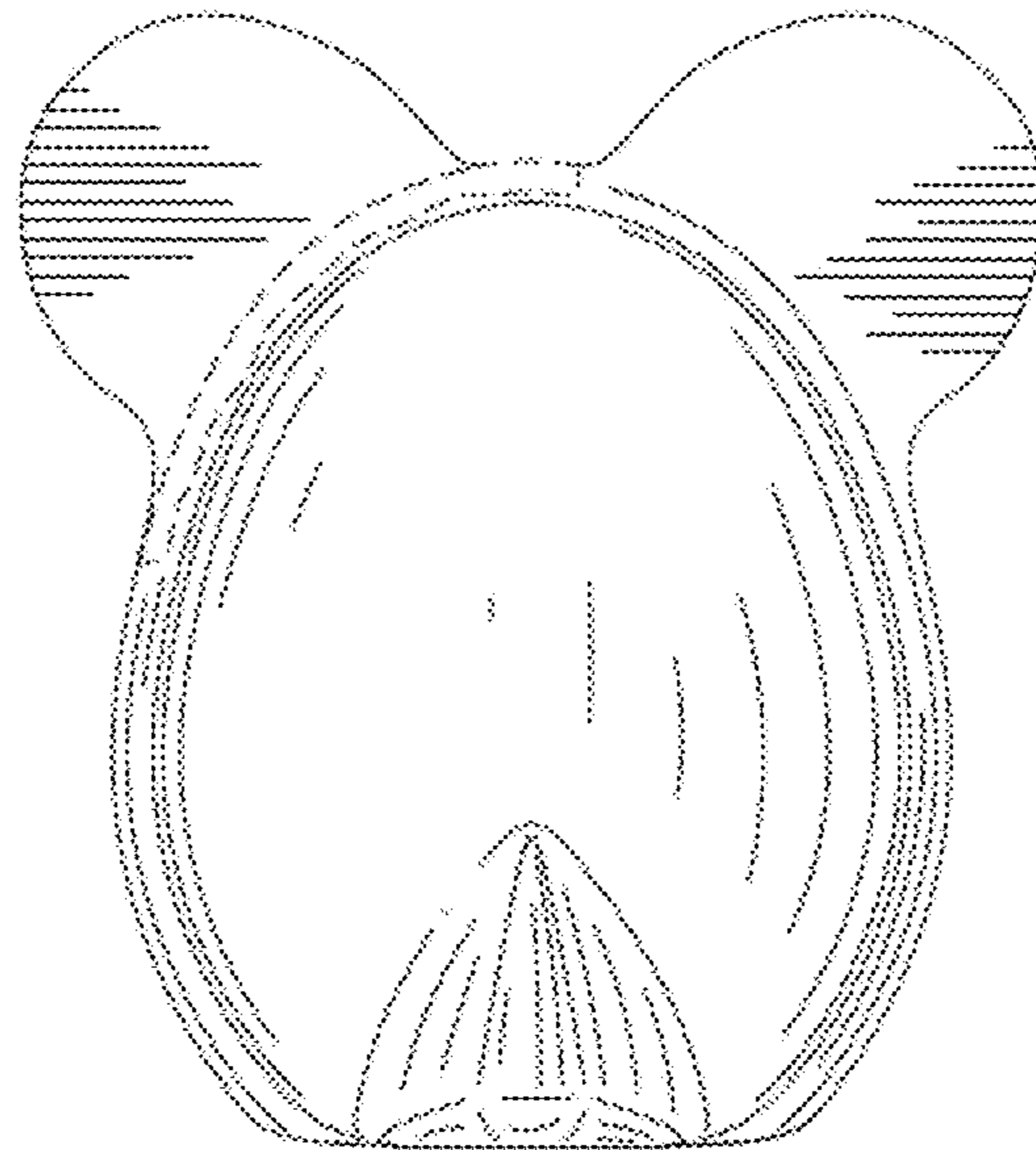

FIG. 44

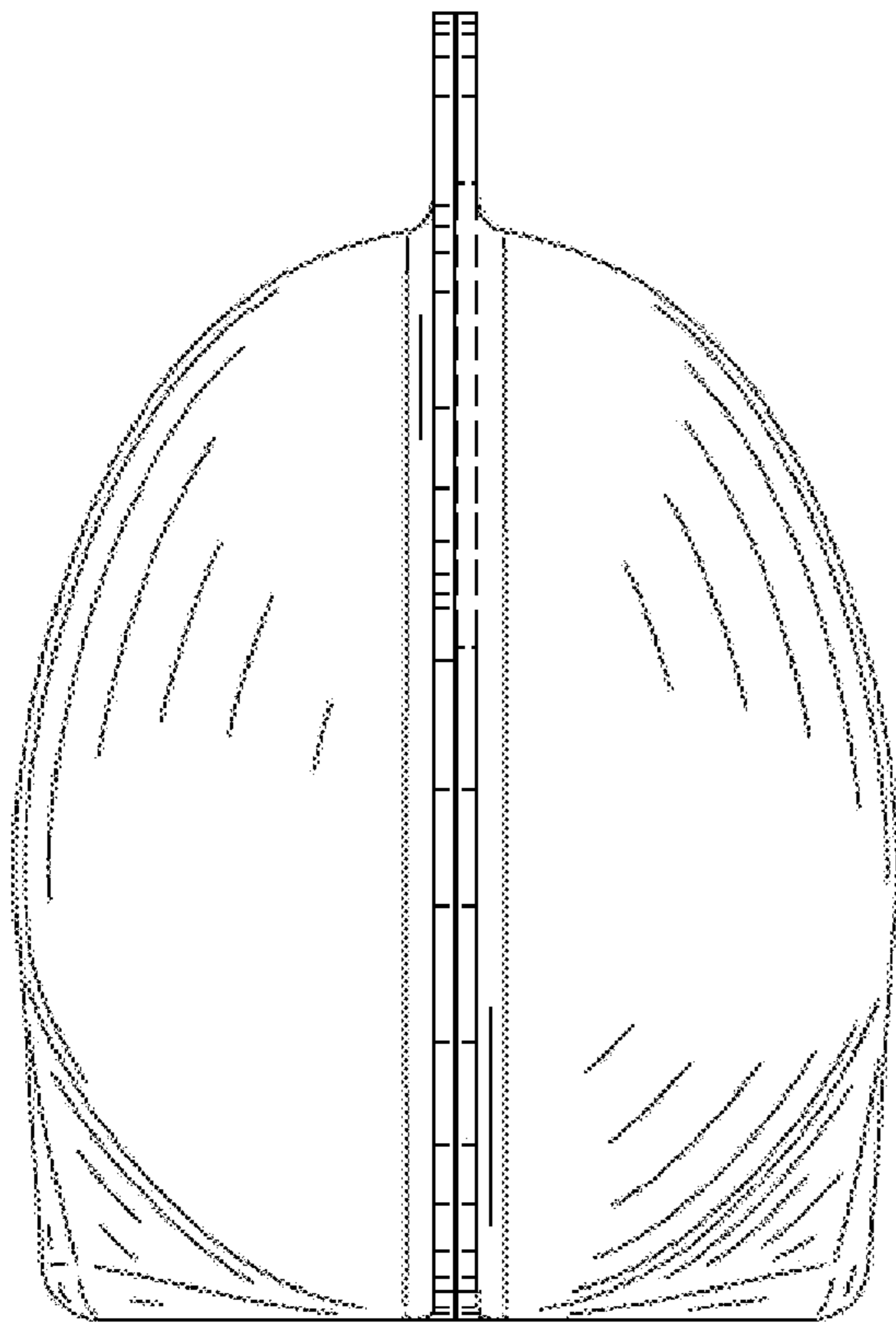

FIG. 45

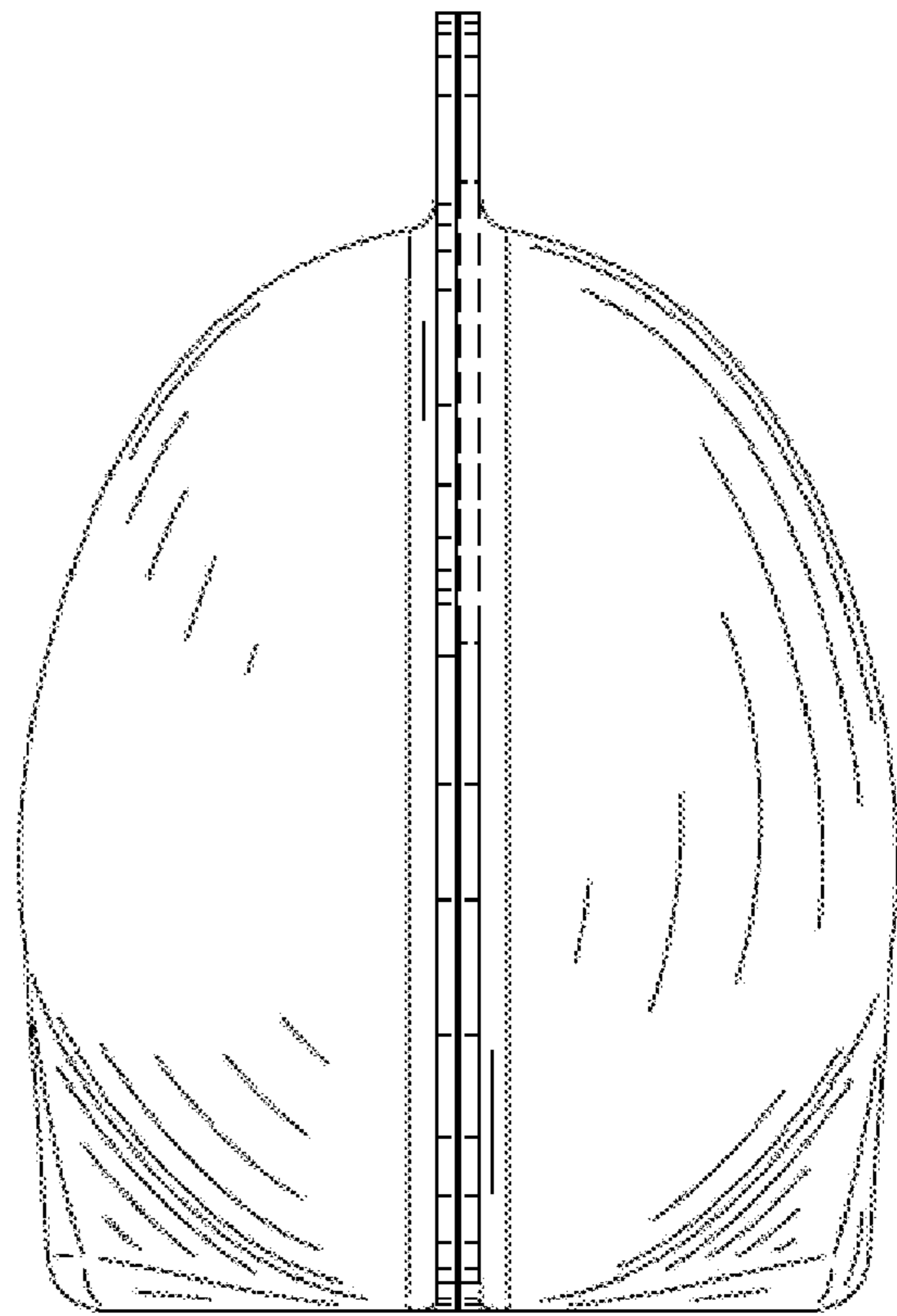

FIG. 46

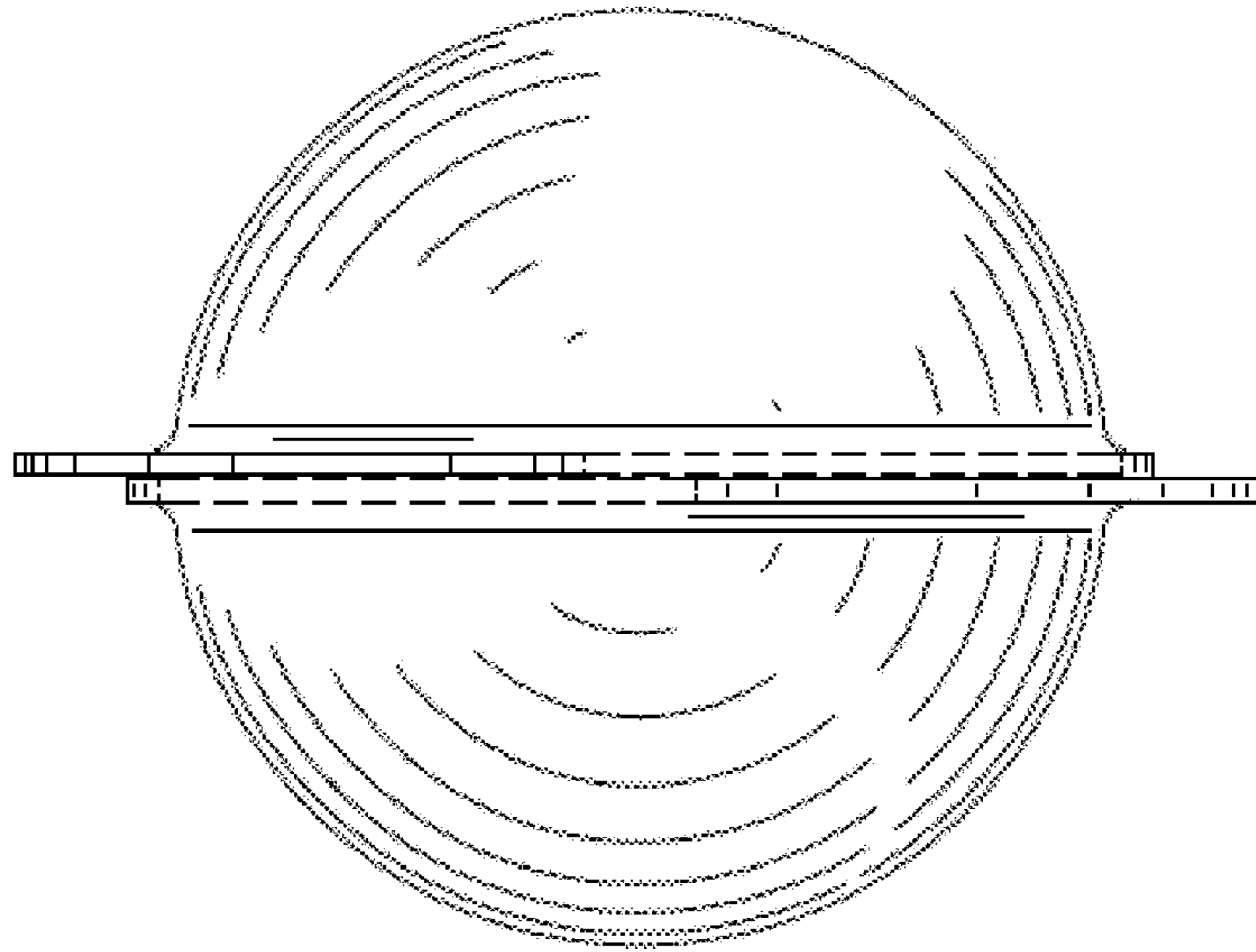

FIG. 47

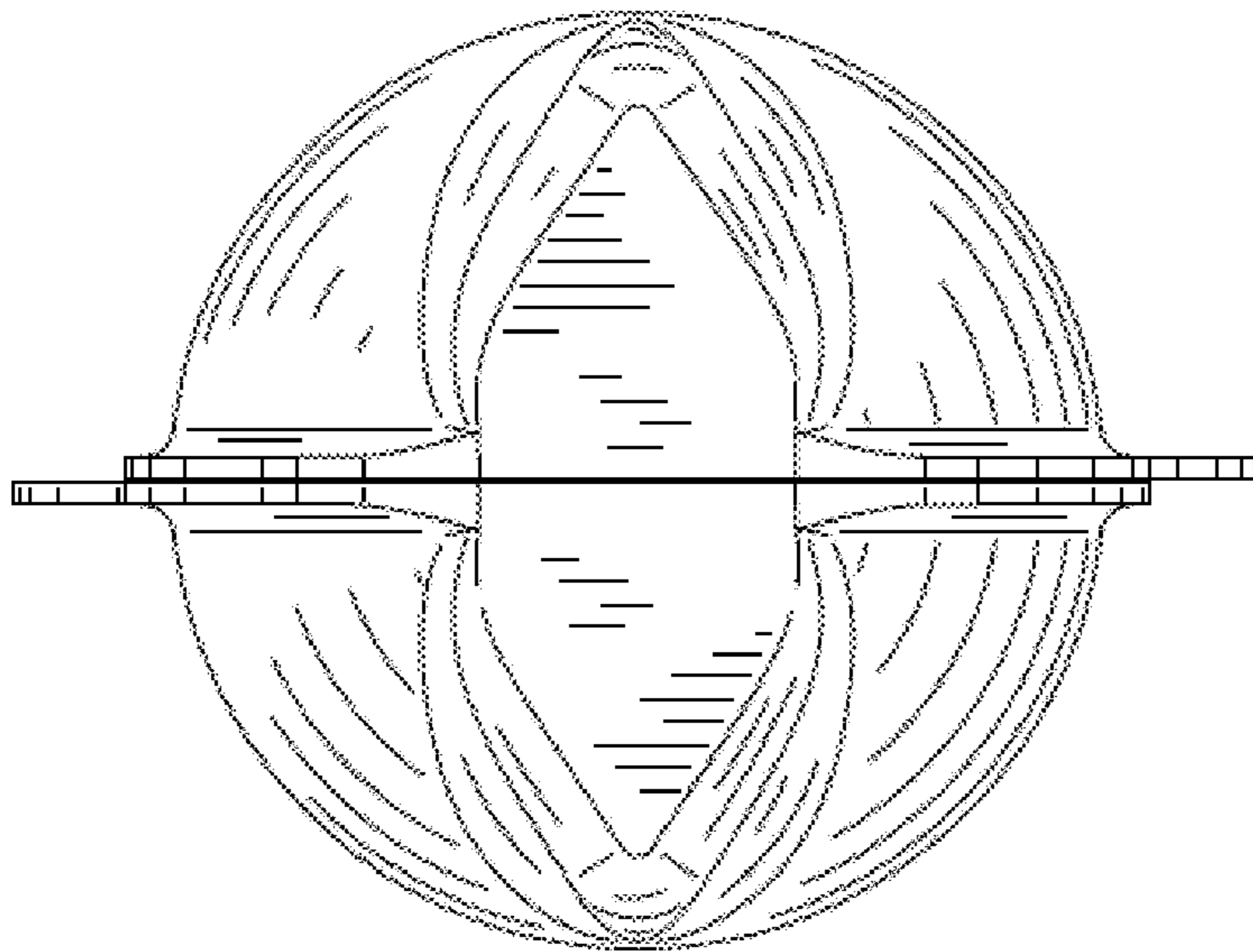

FIG. 48

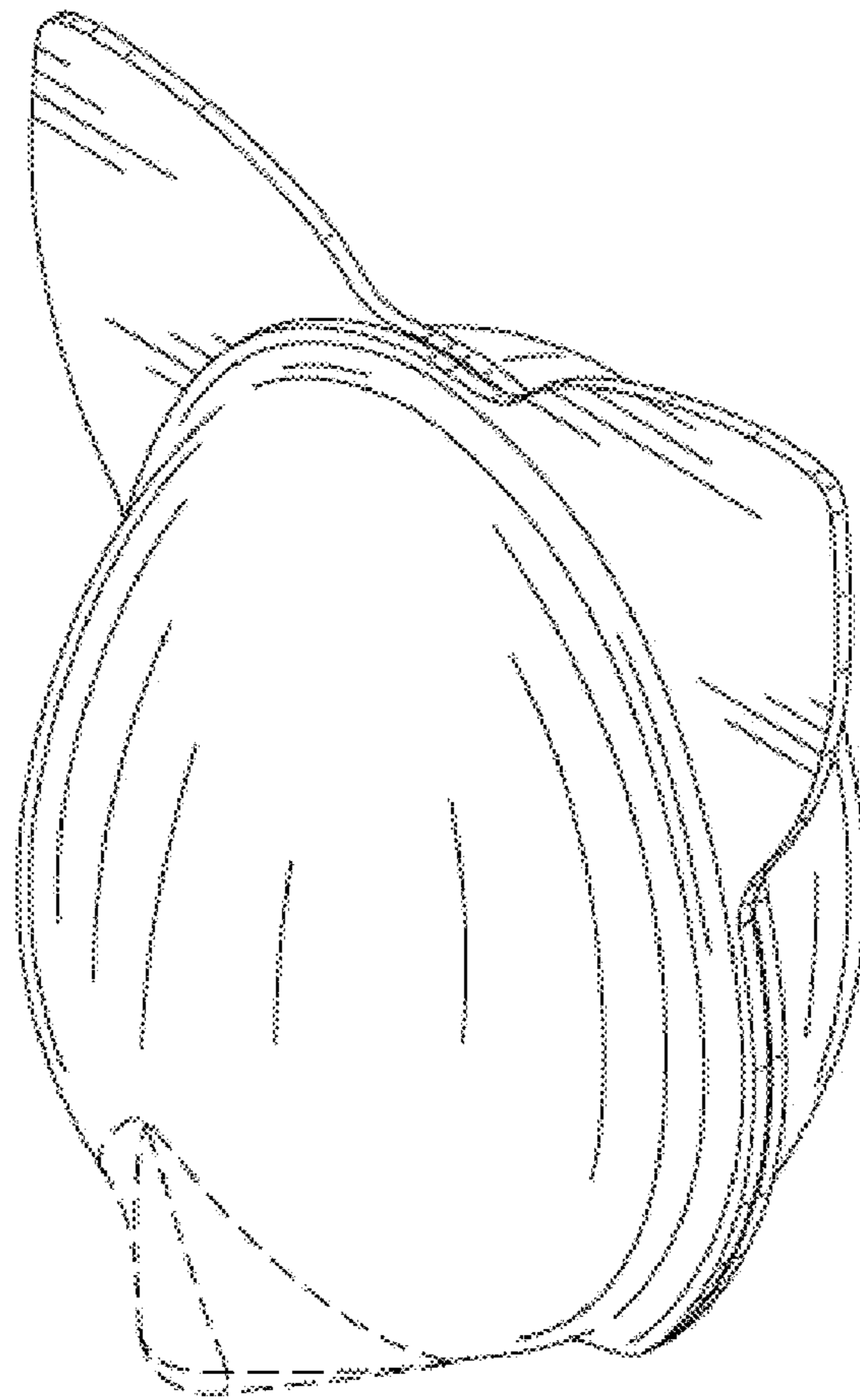

FIG. 49

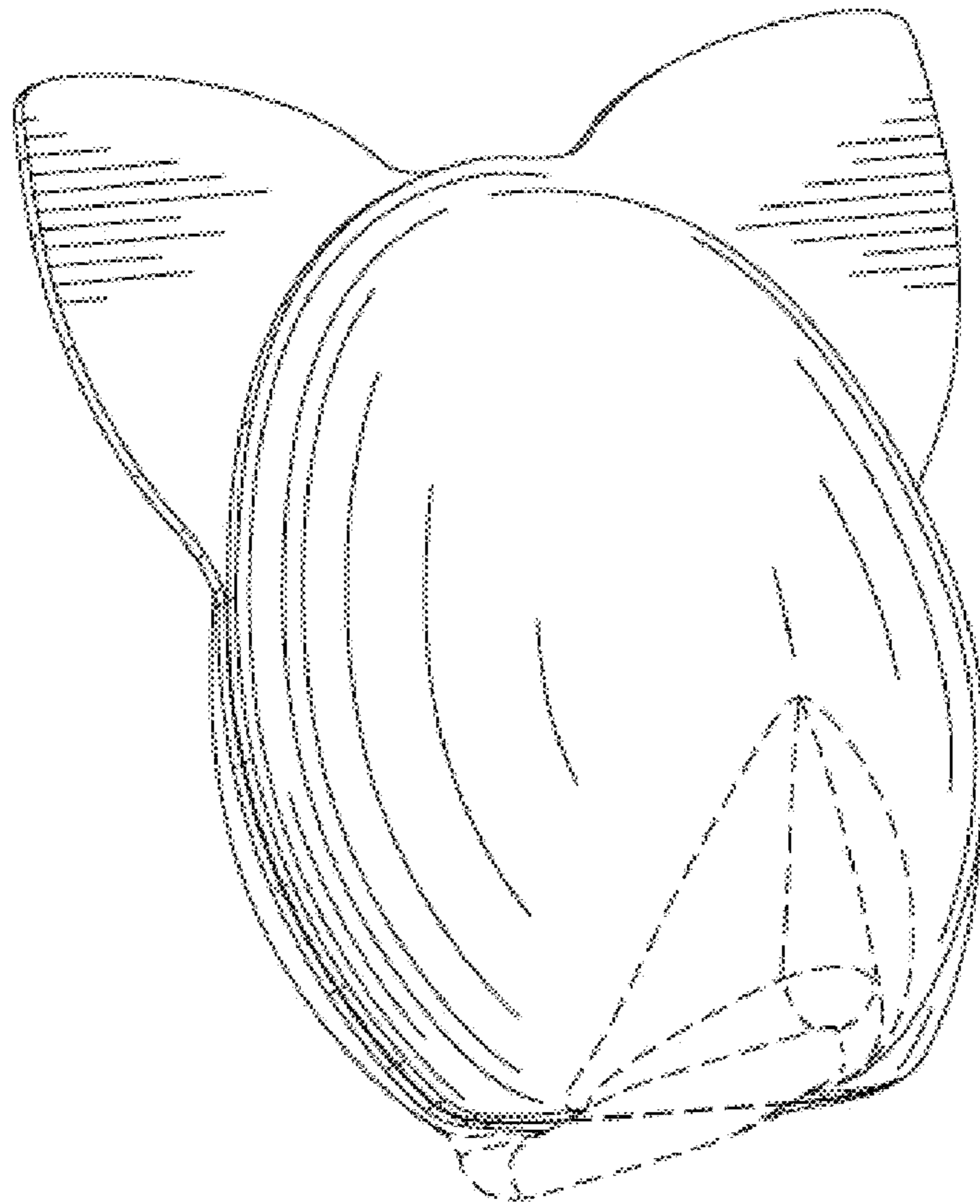

FIG. 50

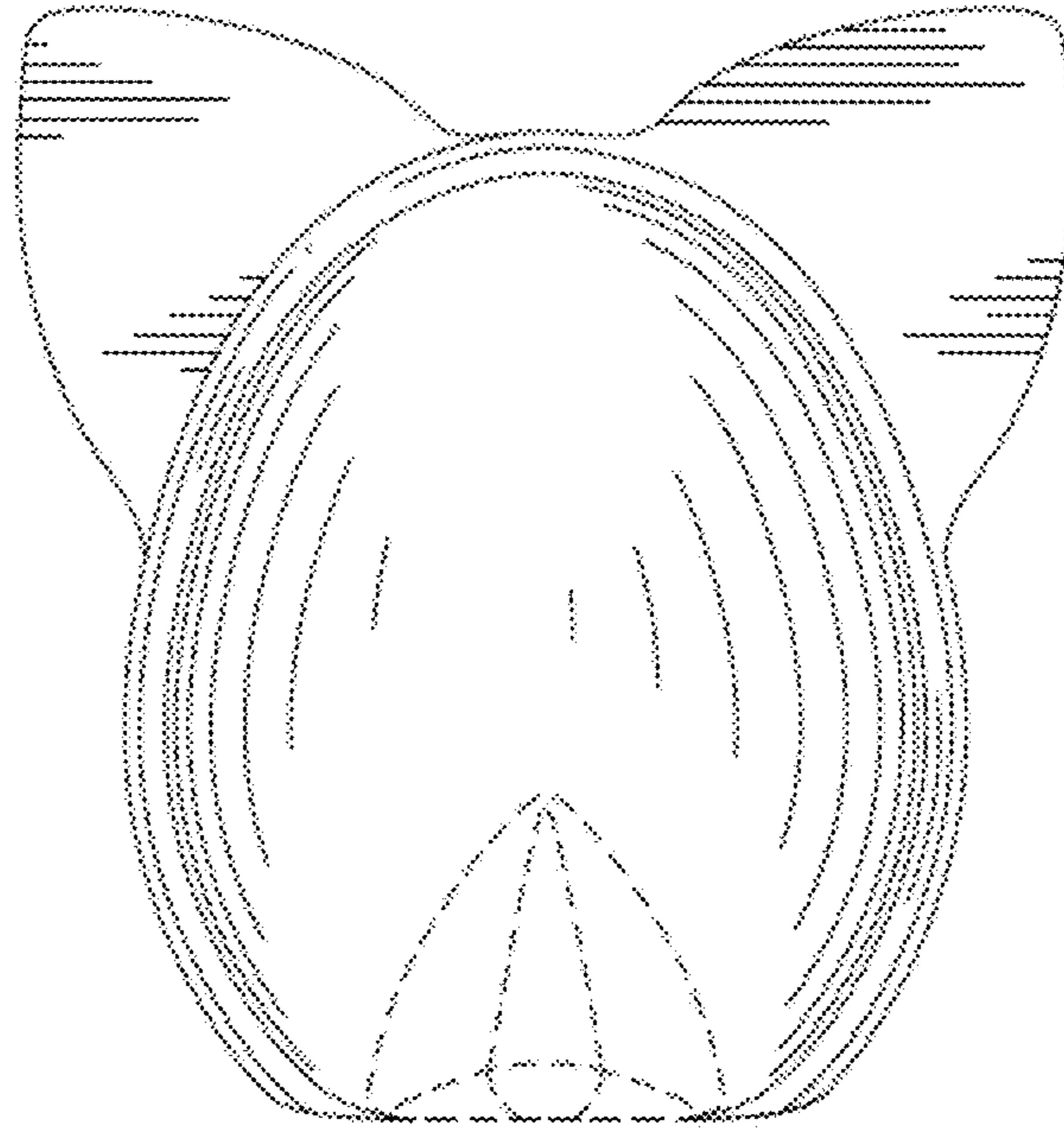

FIG. 51

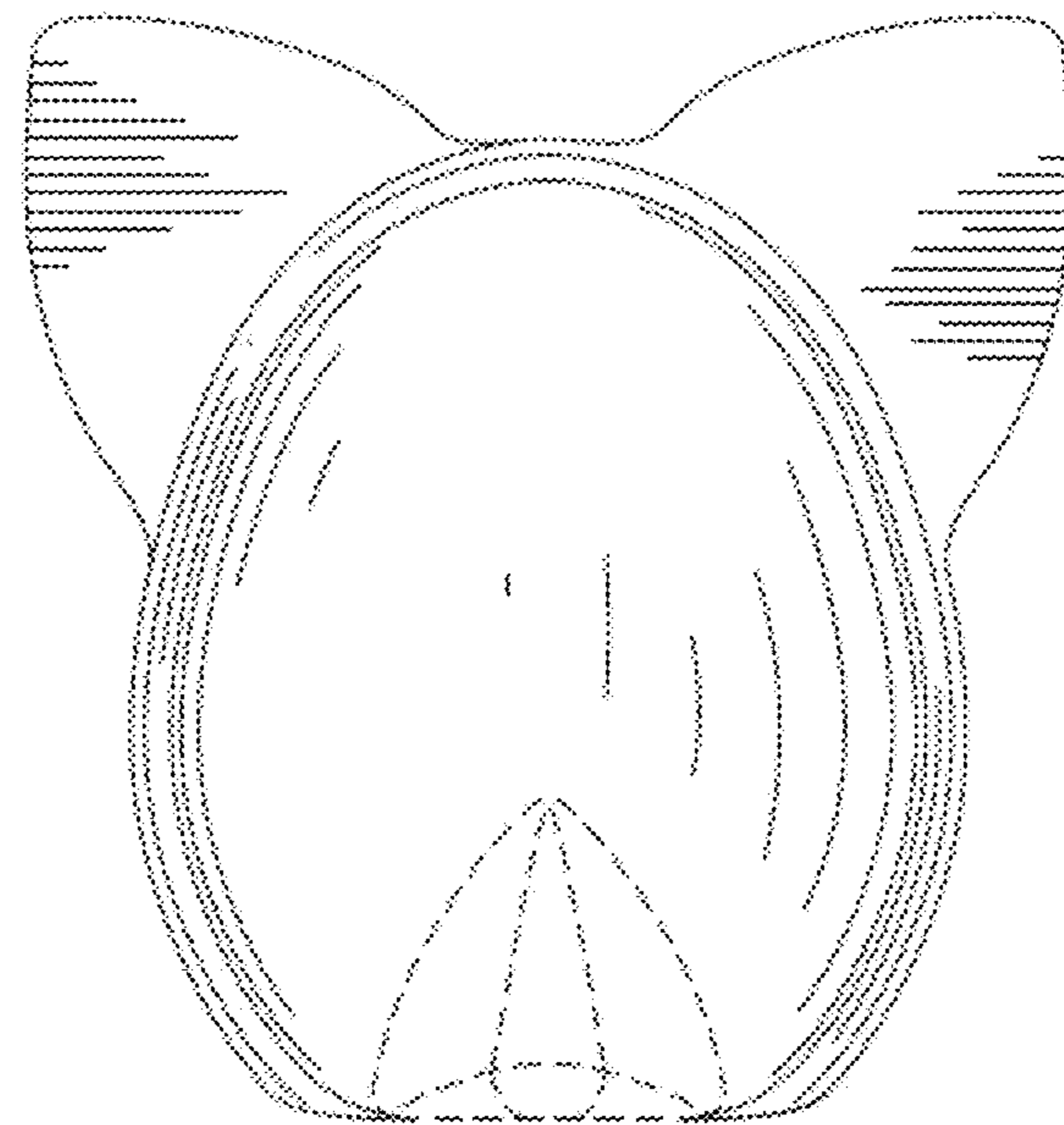

FIG. 52

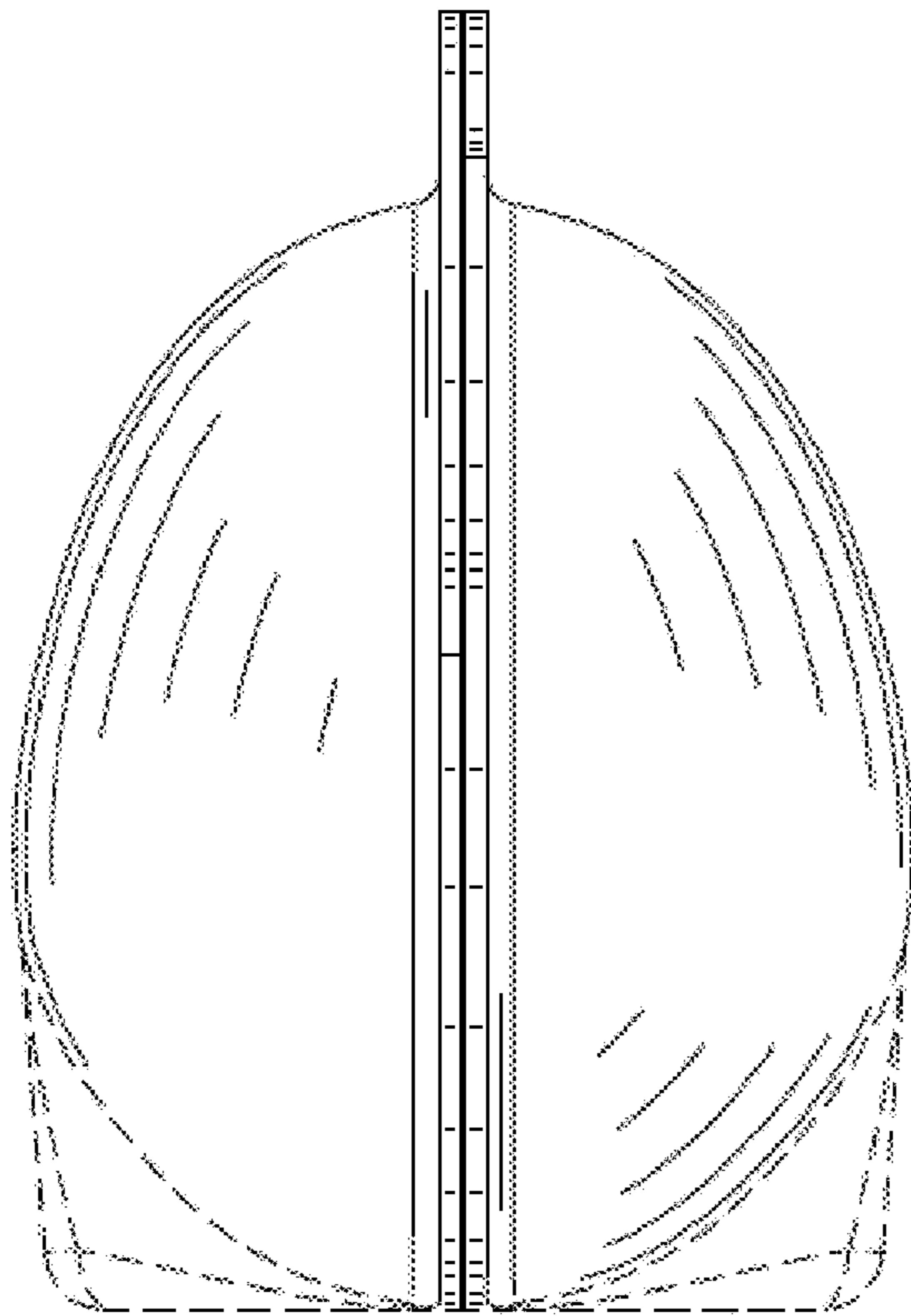

FIG. 53

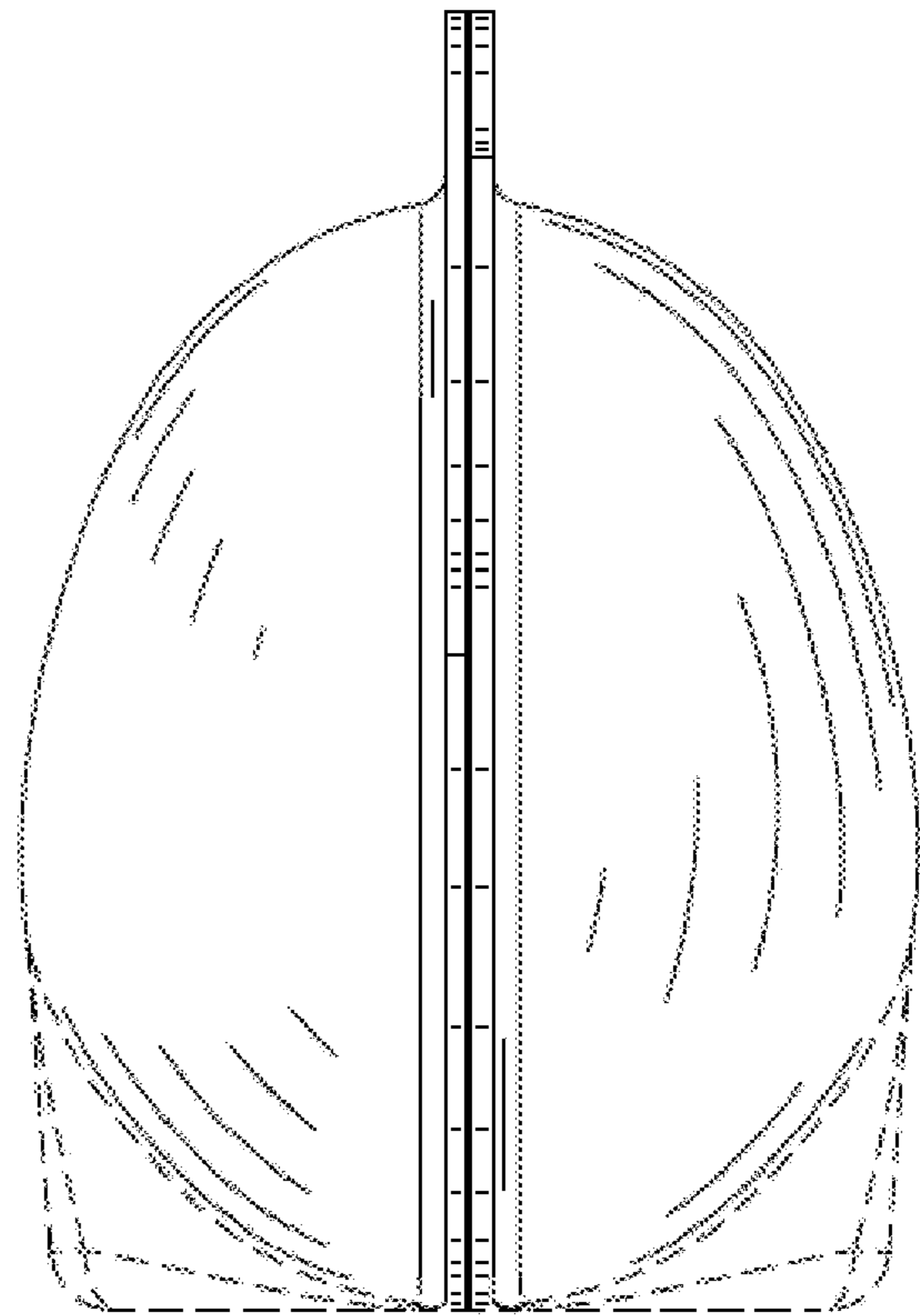

FIG. 54

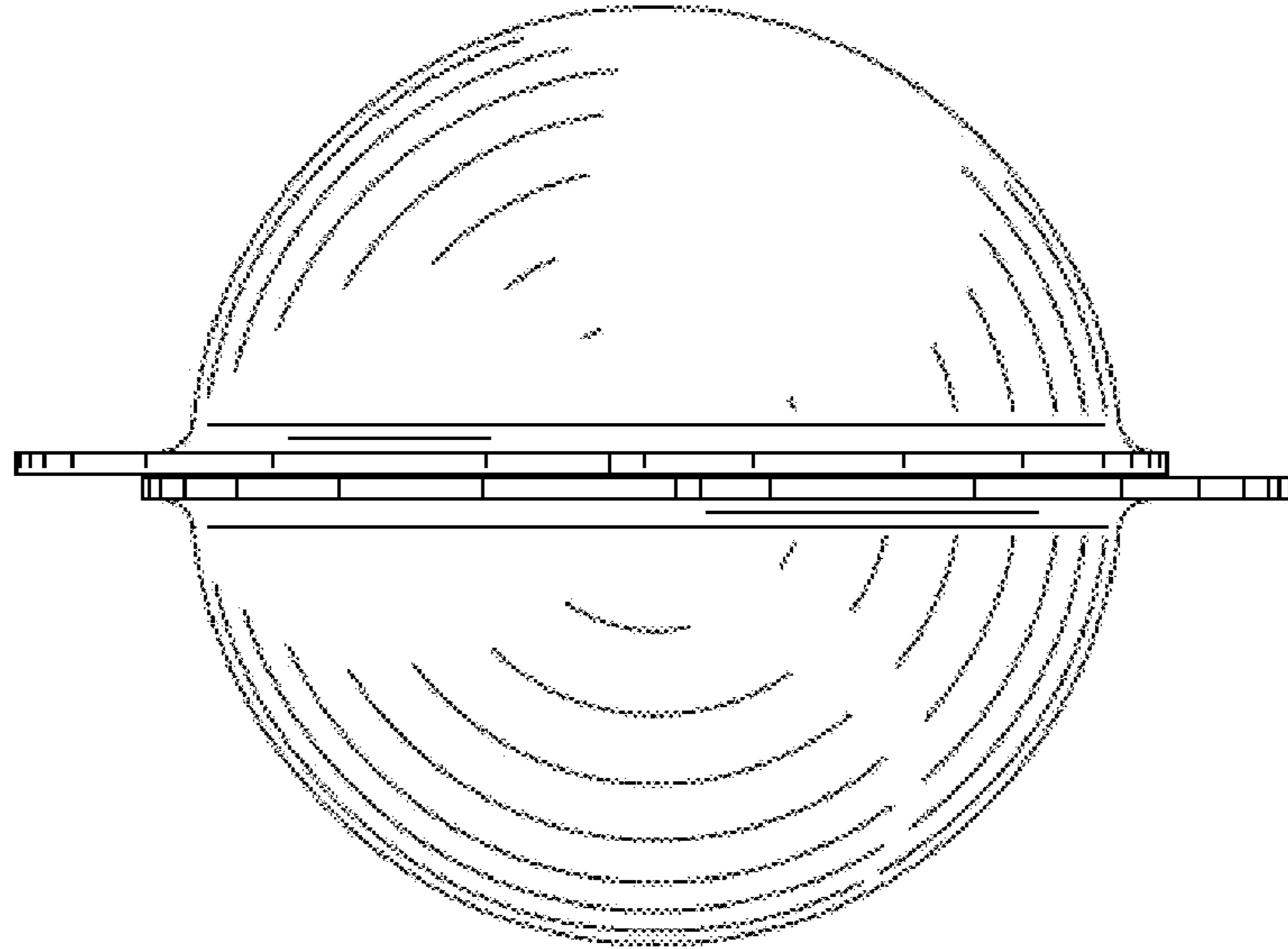

FIG. 55

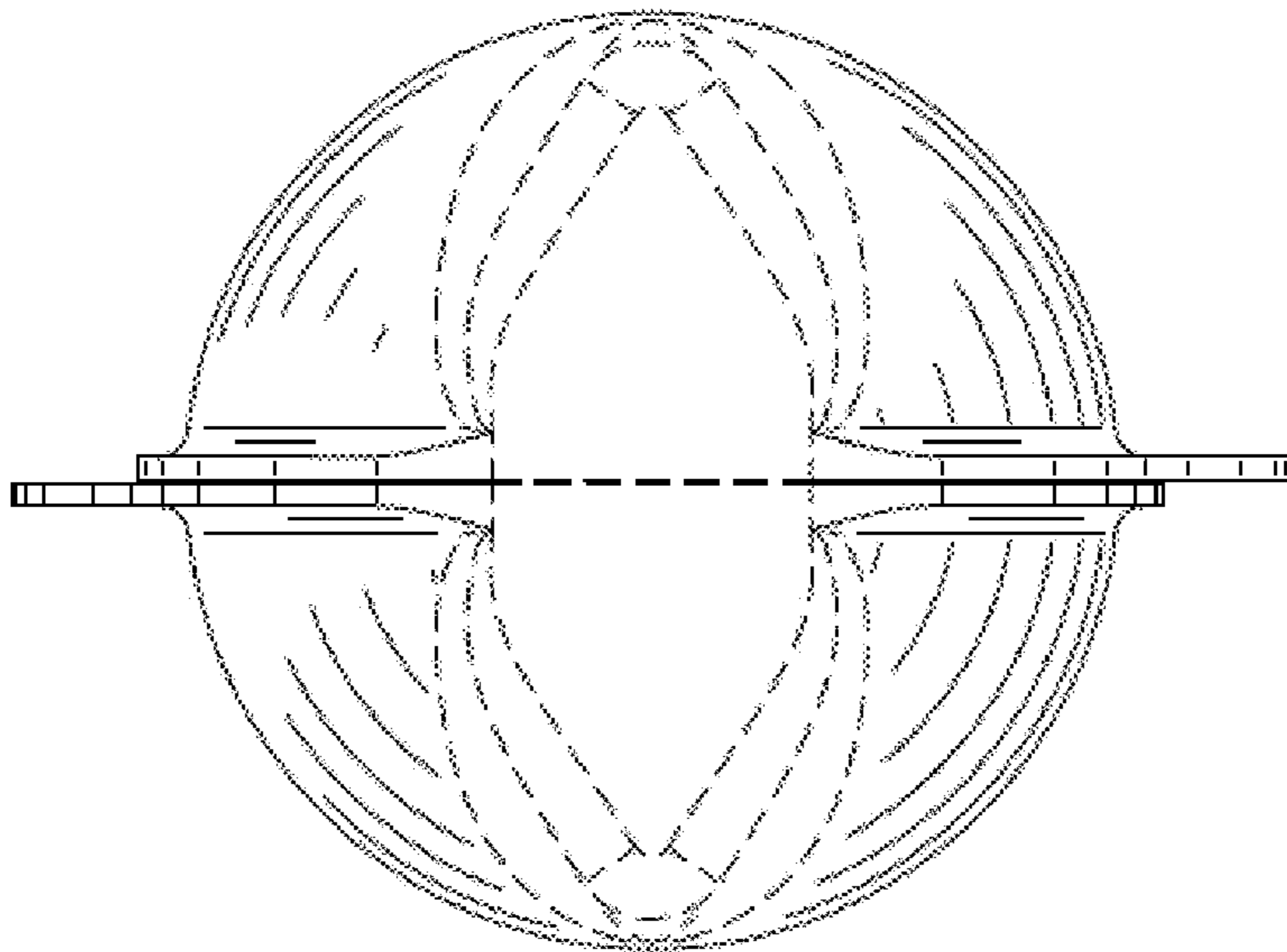

FIG. 56