



US00D913039S

(12) **United States Design Patent** (10) **Patent No.:** **US D913,039 S**
Smith et al. (45) **Date of Patent:** **** Mar. 16, 2021**

(54) **SPLASH GUARD FOR A BEVERAGE DISPENSER HOLSTER**

(71) Applicant: **Soda Gun Jetter LLC**, Mt. Laurel, NJ (US)

(72) Inventors: **Gary Smith**, Mullica Hill, NJ (US);
Joseph Nicholson, Moorestown, NJ (US)

(**) Term: **15 Years**

(21) Appl. No.: **29/648,152**

(22) Filed: **May 18, 2018**

(51) **LOC (13) Cl.** **07-99**

(52) **U.S. Cl.**
USPC **D7/397**

(58) **Field of Classification Search**
USPC D7/396.1, 397, 400, 409, 213; D9/434,
D9/435, 456, 499; D8/14, 16, 19;
D19/37, 40, 108, 111
CPC B01D 29/0095; B05C 17/06; B05C 17/10
See application file for complete search history.

(56) **References Cited**

U.S. PATENT DOCUMENTS

D402,514 S *	12/1998	Killins	D8/16
D547,147 S *	7/2007	Tran	D8/19
D569,699 S *	5/2008	Snick	D8/19
D577,555 S *	9/2008	MacDonald	D8/19
D685,236 S *	7/2013	Barnhart	D8/19
D702,517 S *	4/2014	Wilson	D8/19
D743,761 S *	11/2015	Dioguardi	D8/19
D799,241 S *	10/2017	Sublett	D6/592
D875,906 S *	2/2020	Hyde	D23/308
D877,302 S *	3/2020	Hyde	D23/308
2002/0174749 A1 *	11/2002	Clemons	B25F 1/00 81/490

OTHER PUBLICATIONS

Christmas Bell Cut Out | posted at etsy.com, no posting date © 2020
Etsy.com, [online], [site visited Nov. 16, 2020]. Available from
Internet, <URL: <https://www.etsy.com/listing/872639710/christmas-bell-cut-out?gpla=>> (Year: 2020).*

(Continued)

Primary Examiner — Susan E Krakower

Assistant Examiner — Andrew Kerr

(74) *Attorney, Agent, or Firm* — Volpe Koenig

(57) **CLAIM**

The ornamental design for a splash guard for a beverage dispenser holster, as shown and described.

DESCRIPTION

FIG. 1 is a perspective view of a splash guard according to our invention;

FIG. 2 is a top view of the splash guard of FIG. 1;

FIG. 3 is a bottom view of the splash guard of FIG. 1;

FIG. 4 is a front plan view of the splash guard of FIG. 1;

FIG. 5 is a rear plan view of the splash guard of FIG. 1;

FIG. 6 is a right side view of the splash guard of FIG. 1;

FIG. 7 is a left side view of the splash guard of FIG. 1;

FIG. 8 is a perspective view of the splash guard prior to insertion in a beverage dispenser holster, with the beverage dispenser holster illustrated in broken lines to show environmental features; and,

FIG. 9 is a perspective view of the splash guard inserted in the beverage dispenser holster, with the beverage dispenser holster illustrated in broken lines to show environmental features.

The broken lines illustrate environmental structure and form no part of the claimed design.

1 Claim, 6 Drawing Sheets

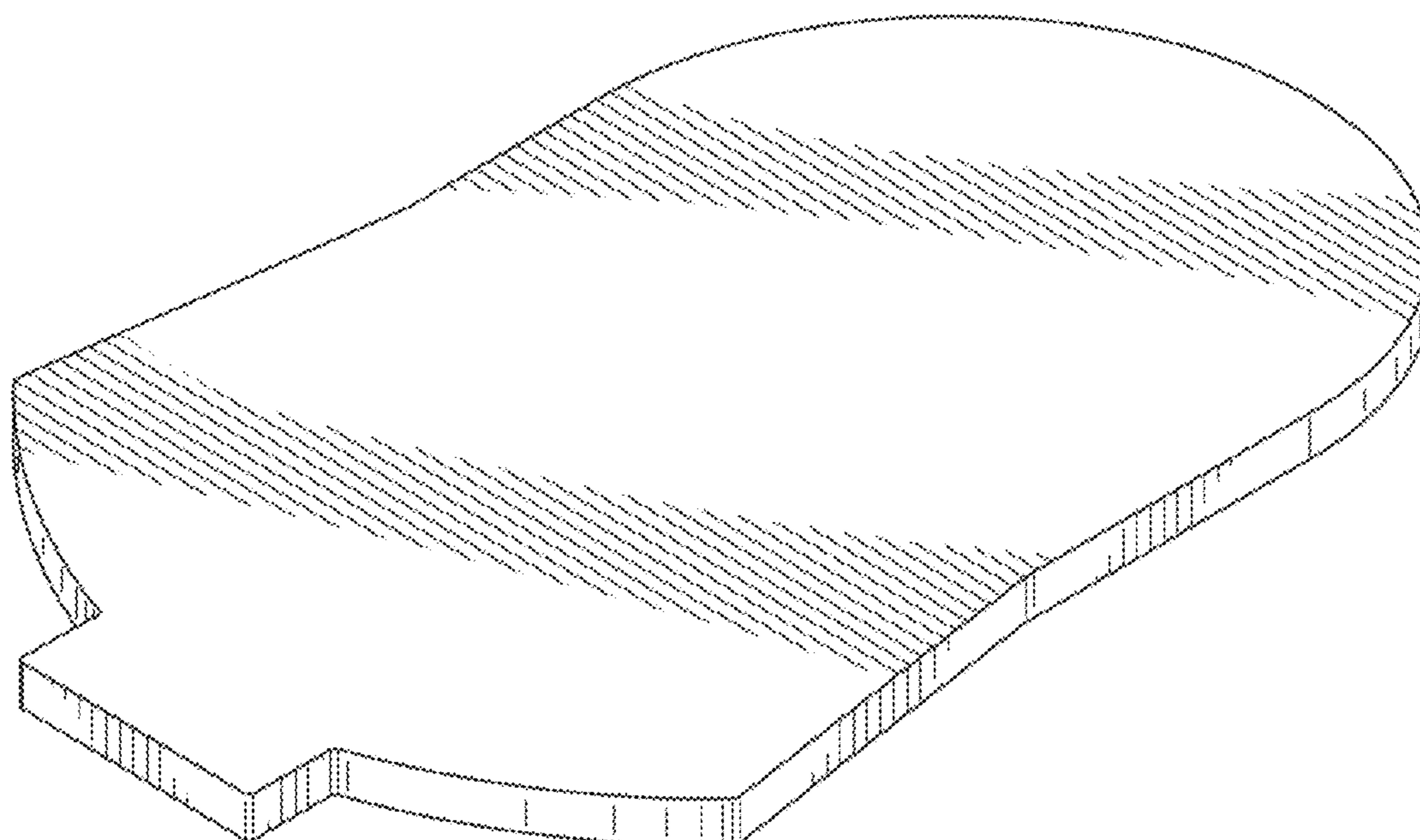

(56)

References Cited

OTHER PUBLICATIONS

BESTOYARD 10PCS Ornament | posted at amazon.com, no posting date © 1996-2020 Amazon.com, [online], [site visited Nov. 16, 2020]. Available from Internet, <URL: <https://www.amazon.com/BESTOYARD-Christmas-Ornaments-Holidays-Decorations/dp/B07KCTD1ZK/>> (Year: 2020).*

TUPARKA 60PCS Ornaments | posted at amazon.com, Nov. 8, 2019 © 1996-2020 Amazon.com, [online], [site visited Nov. 16, 2020]. Available from Internet, <URL: <https://www.amazon.com/TUPARKA-Unfinished-Twine%EF%BC%8CColorful-Bells%EF%BC%8CFlashing-Decoration%EF%BC%886/dp/B08160QJ426/>> (Year: 2019).*

* cited by examiner

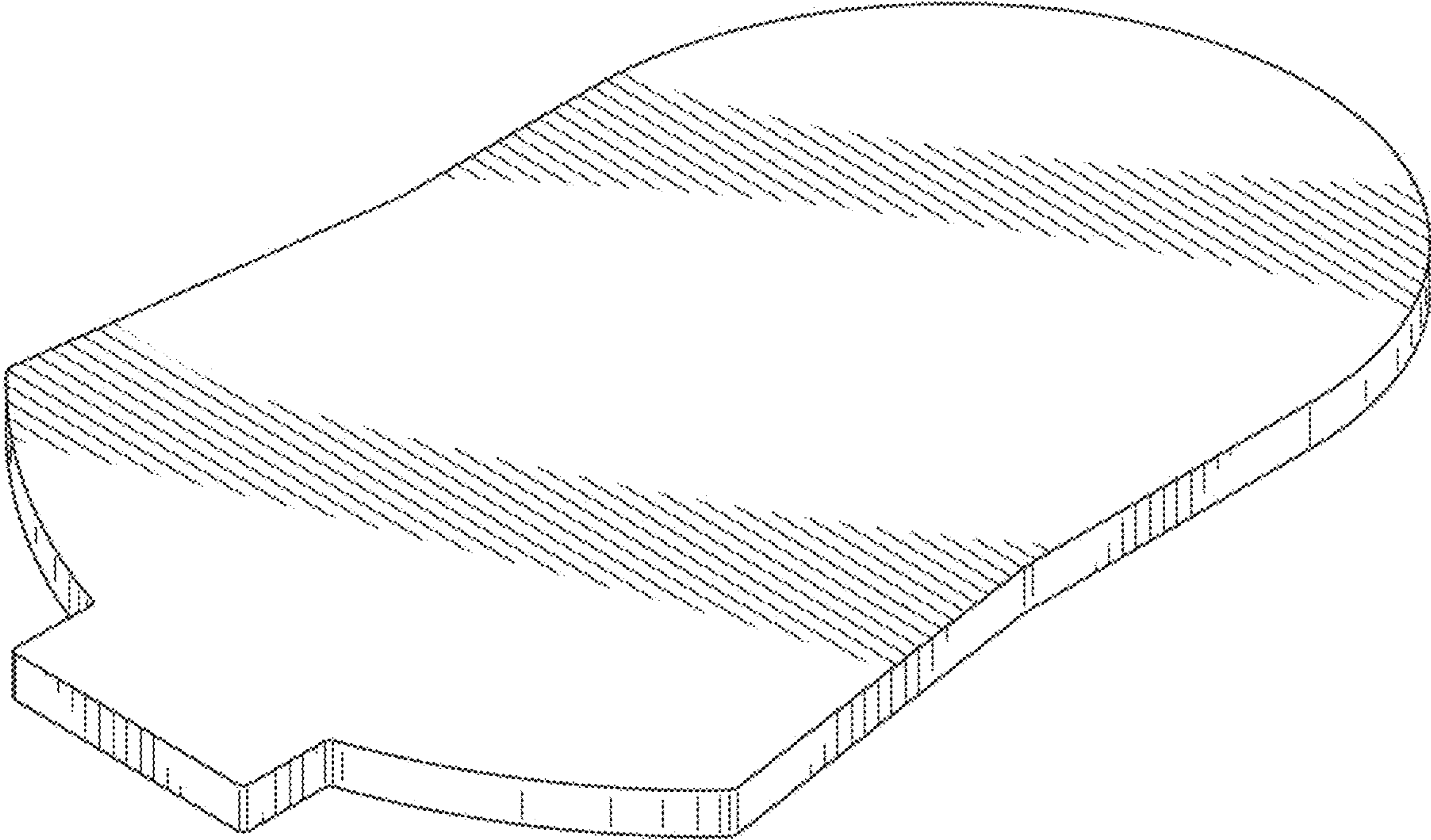

FIG. 1

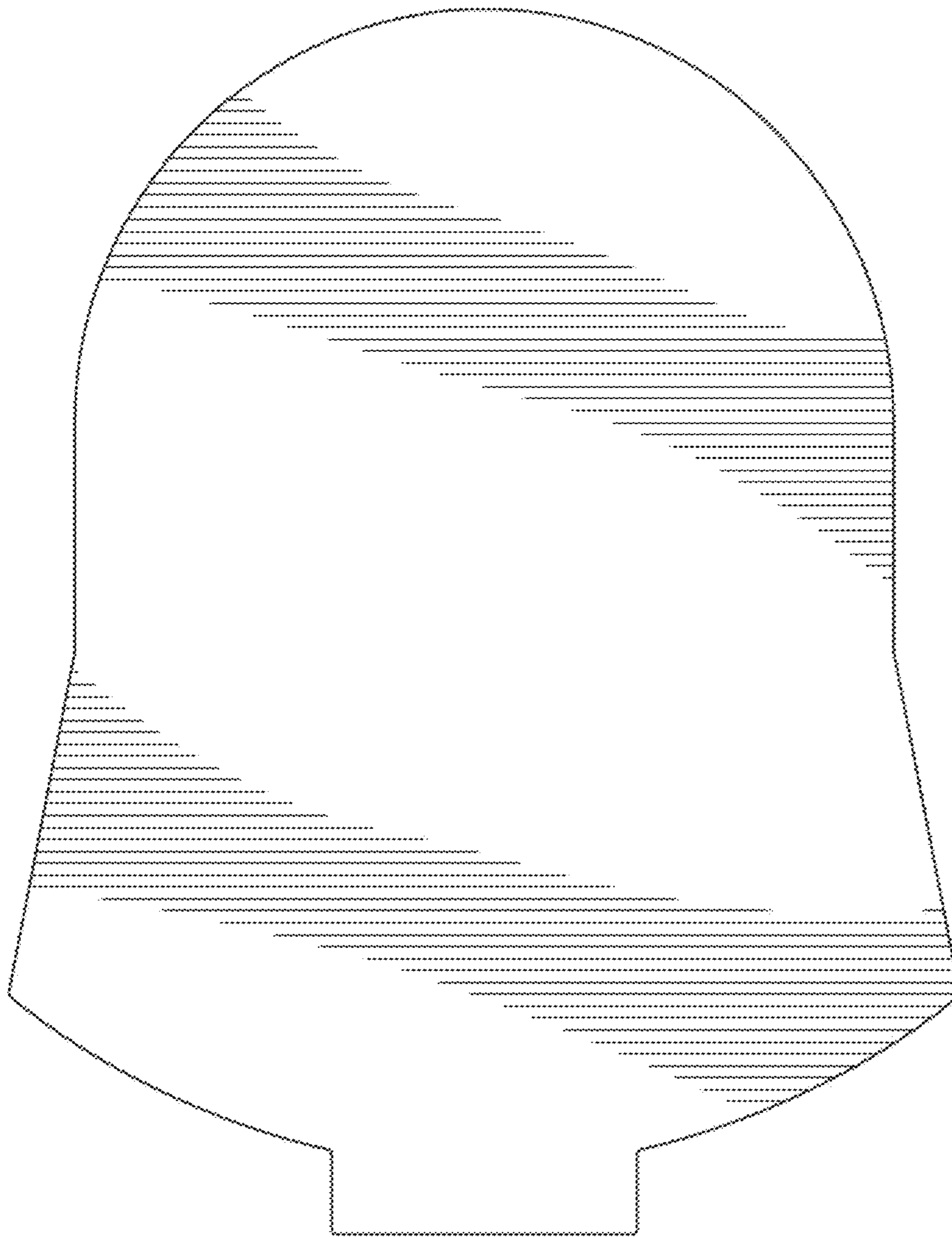

FIG. 2

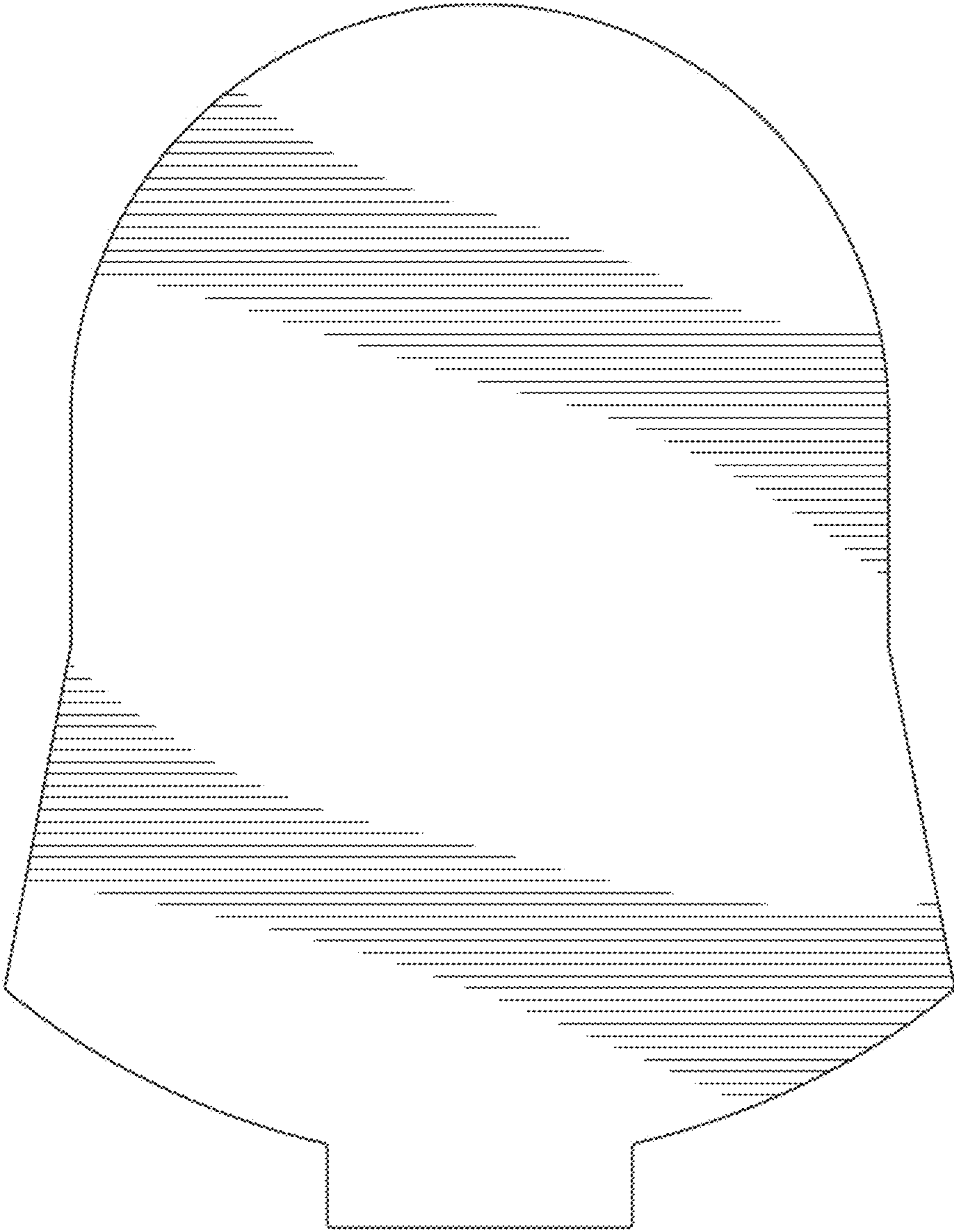

FIG. 3



FIG. 4

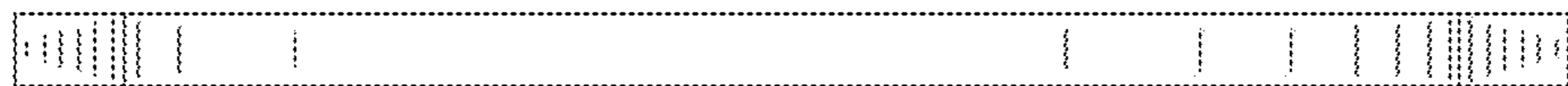

FIG. 5



FIG. 6

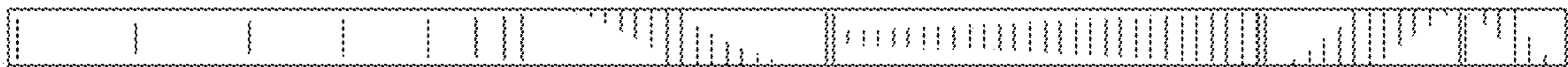

FIG. 7

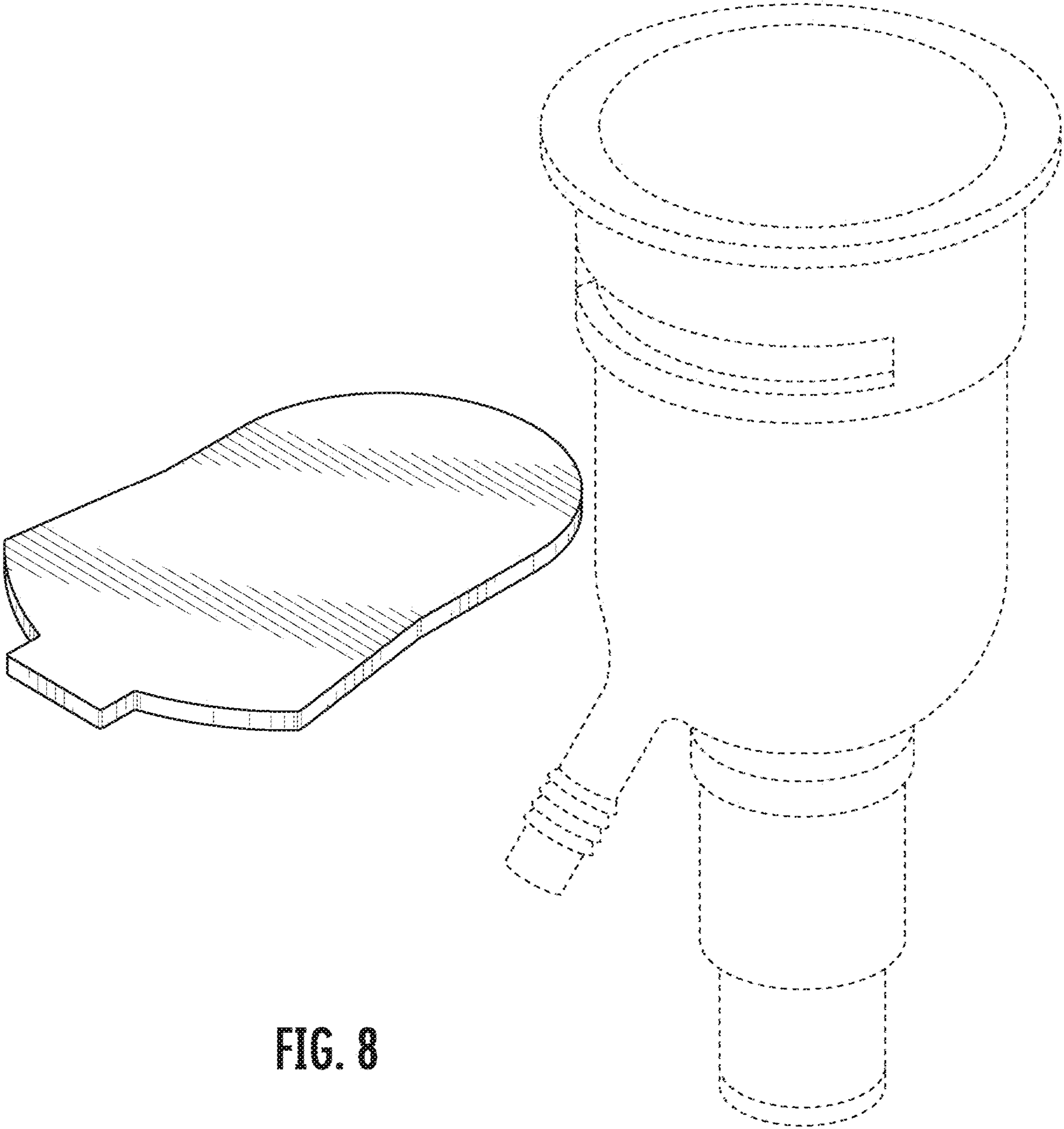

FIG. 8

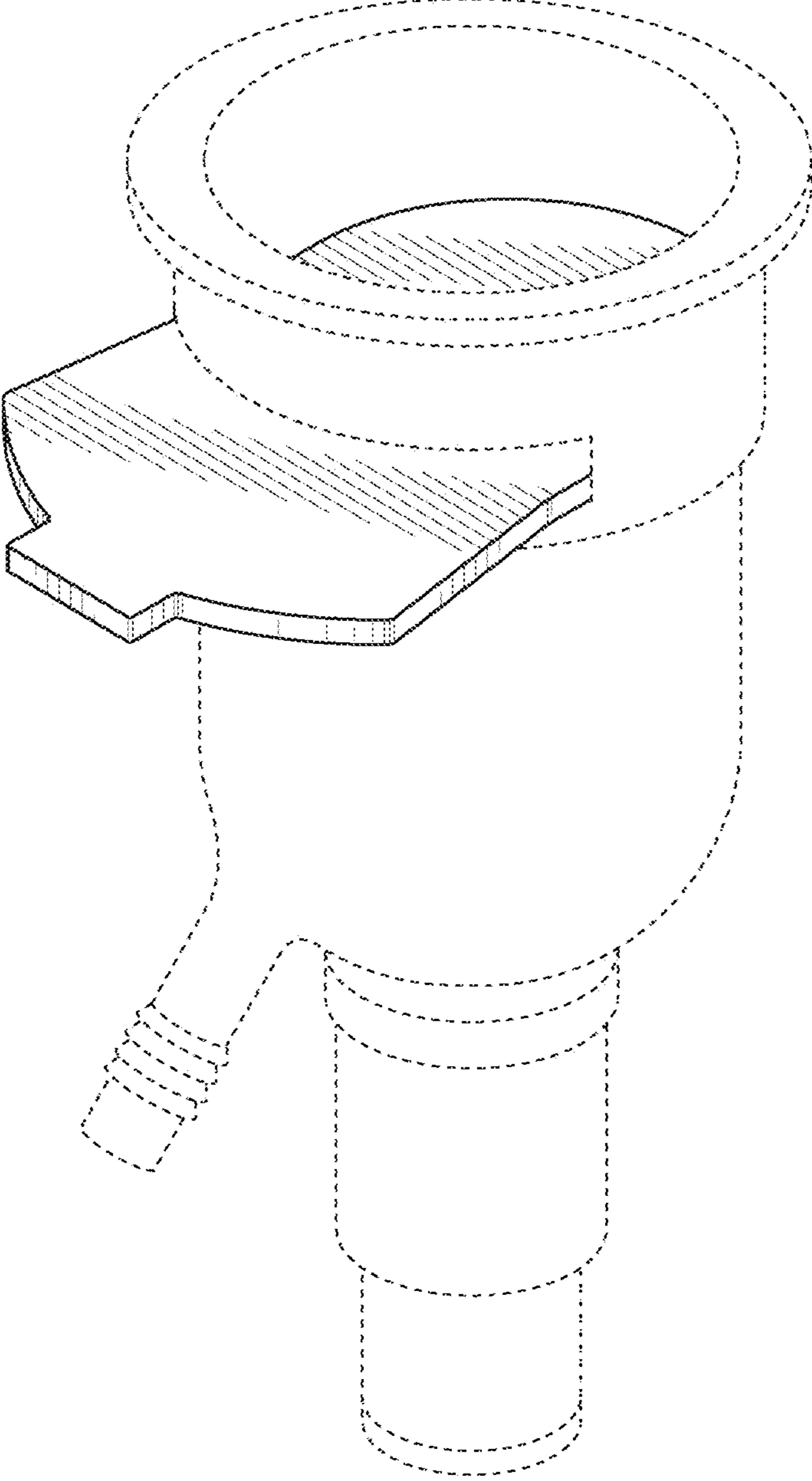

FIG. 9