



US00D913025S

(12) **United States Design Patent** (10) **Patent No.:** **US D913,025 S**
Mu (45) **Date of Patent:** **** Mar. 16, 2021**

- (54) **FRAME FOR BEDSIDE CRIB**
- (71) Applicant: **Redline Commerce Inc.**, City of Industry, CA (US)
- (72) Inventor: **Mengmeng Mu**, Ningbo (CN)
- (73) Assignee: **Redline Commerce Inc.**, City of Industry, CA (US)
- (**) Term: **15 Years**
- (21) Appl. No.: **29/688,691**
- (22) Filed: **Apr. 23, 2019**
- (51) **LOC (13) Cl.** **06-06**
- (52) **U.S. Cl.**
USPC **D6/718.26; D6/718.3**
- (58) **Field of Classification Search**
USPC D6/382-384, 390-392, 718, 718.26, D6/718.3
CPC . A47D 7/04; A47D 7/005; A47D 9/00; A47C 21/08
See application file for complete search history.

- D433,246 S * 11/2000 Pettifer D6/382
- 2014/0259401 A1 * 9/2014 Marsden A47C 21/08 5/426
- 2017/0196373 A1 * 7/2017 Sclare A47D 5/00
- 2018/0192786 A1 * 7/2018 Horst A47D 7/005
- 2020/0046141 A1 * 2/2020 Mu A47D 9/00

* cited by examiner

Primary Examiner — Cathron C Brooks

(74) *Attorney, Agent, or Firm* — Raymond Y. Chan; David and Raymond Patent Firm

(57) **CLAIM**

The ornamental design for a frame for bedside crib, as shown and described.

DESCRIPTION

FIG. 1 is a front perspective view of the frame for bedside crib showing my new design;
 FIG. 2 is a front view of the frame for bedside crib;
 FIG. 3 is a rear view of the frame for bedside crib;
 FIG. 4 is a left view of the frame for bedside crib;
 FIG. 5 is a right view of the frame for bedside crib;
 FIG. 6 is a top view of the frame for bedside crib;
 FIG. 7 is a bottom view of the frame for bedside crib;
 FIG. 8 is a rear perspective view of the frame for bedside crib; and,
 FIG. 9 is a perspective view illustrating the frame being installed on a supporting frame of the bedside crib.
 The broken lines in FIG. 9 represent unclaimed portions of the design article. All of the broken lines form no part of the claimed design.

1 Claim, 7 Drawing Sheets

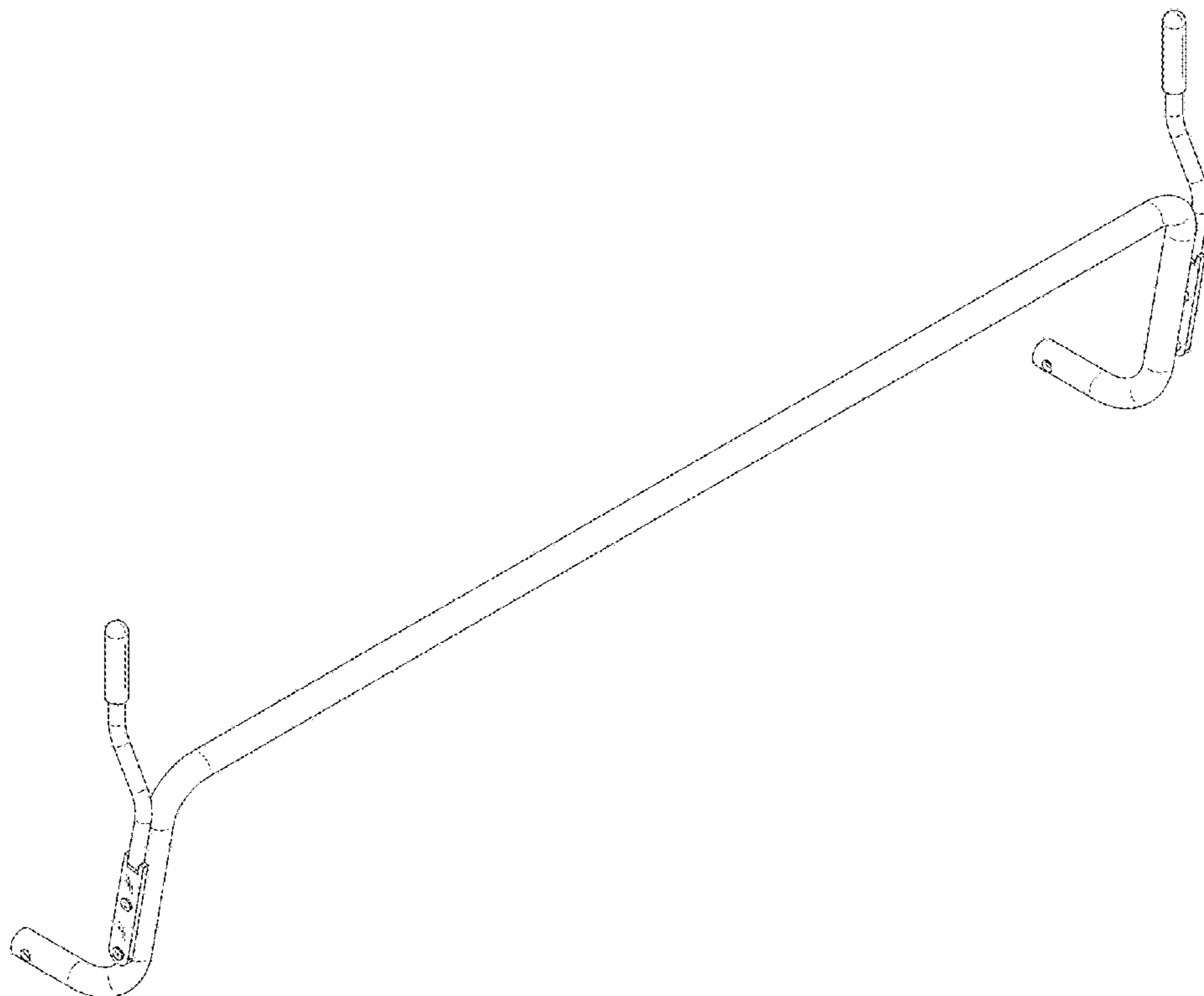

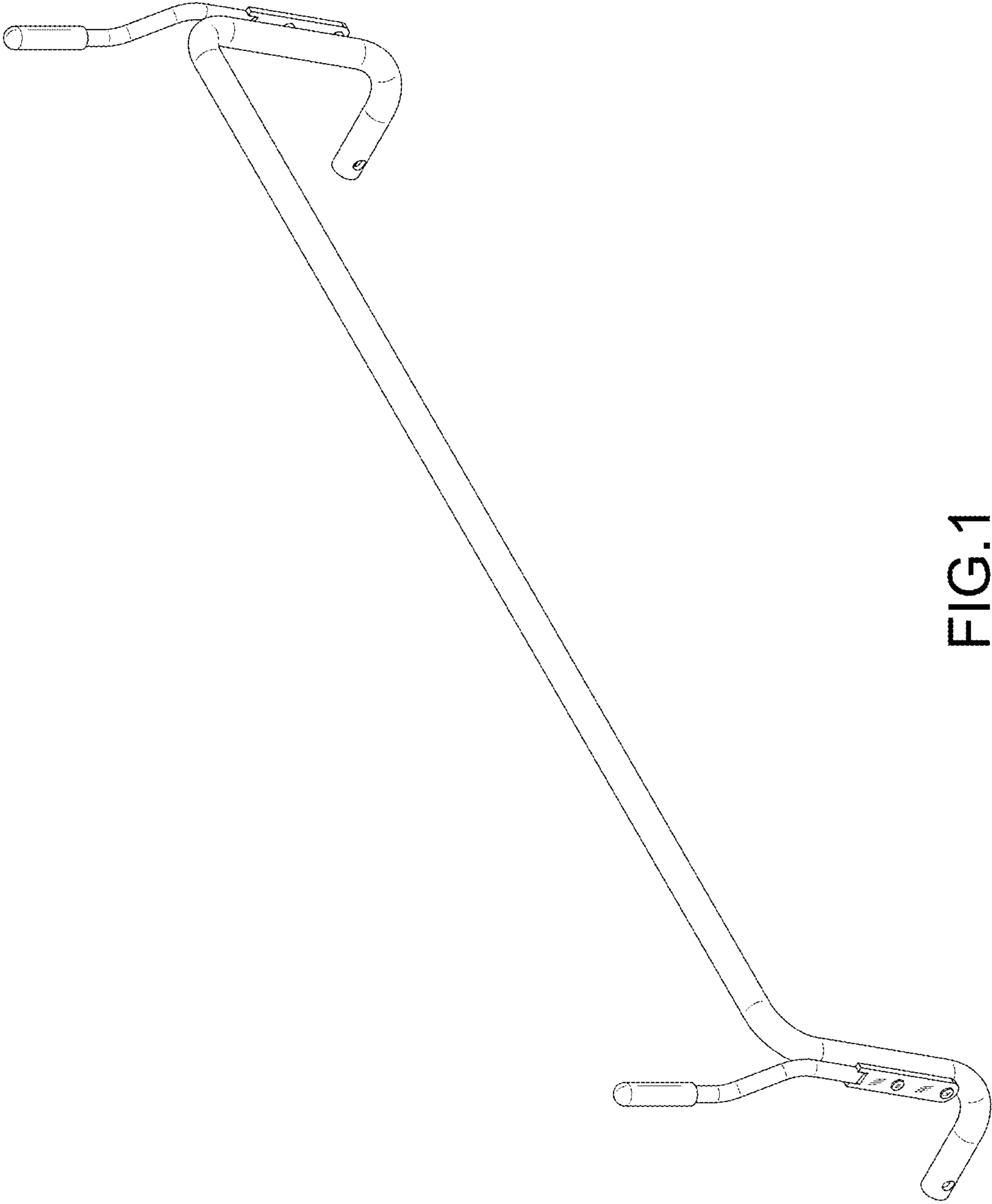

FIG. 1

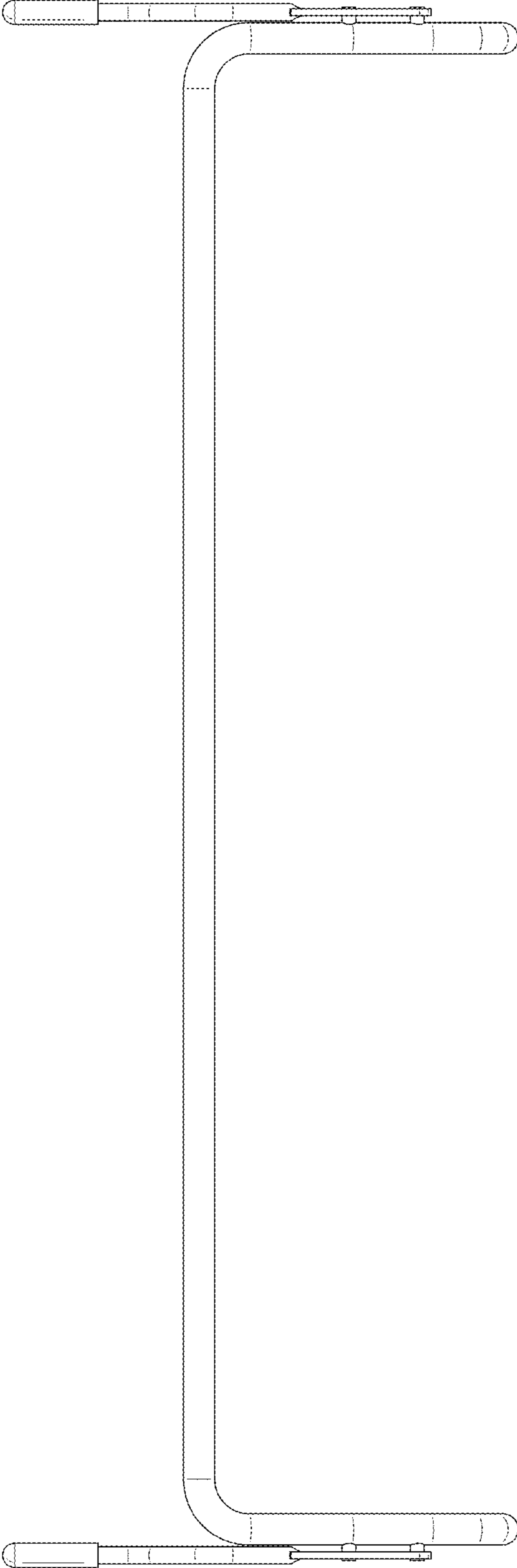

FIG.2

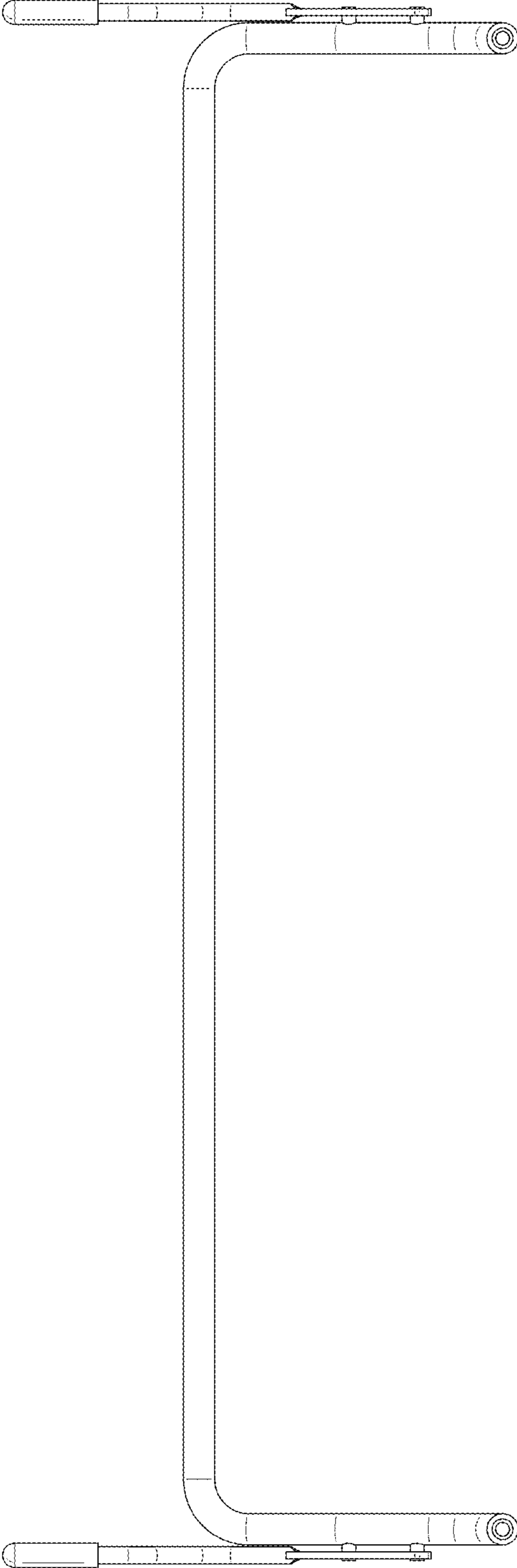

FIG.3

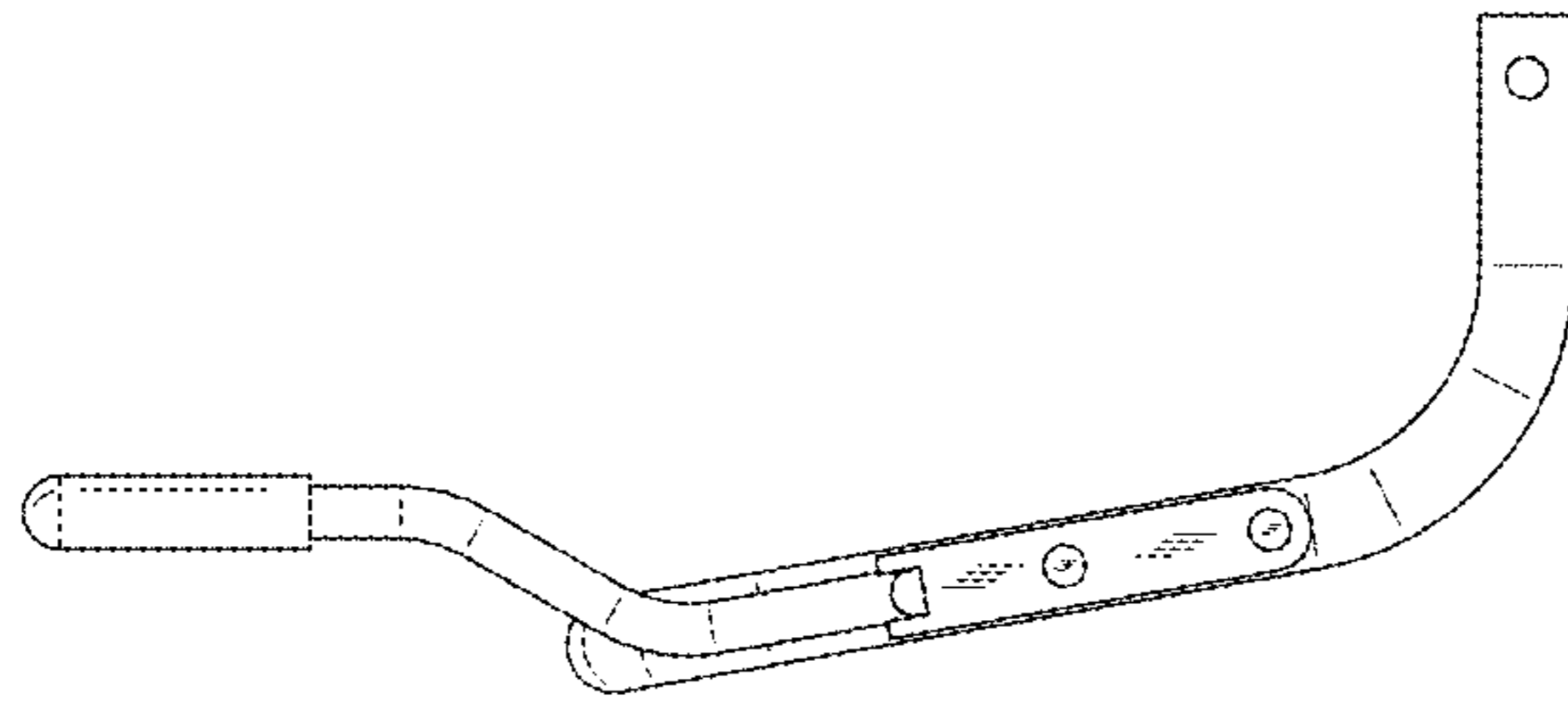

FIG.5

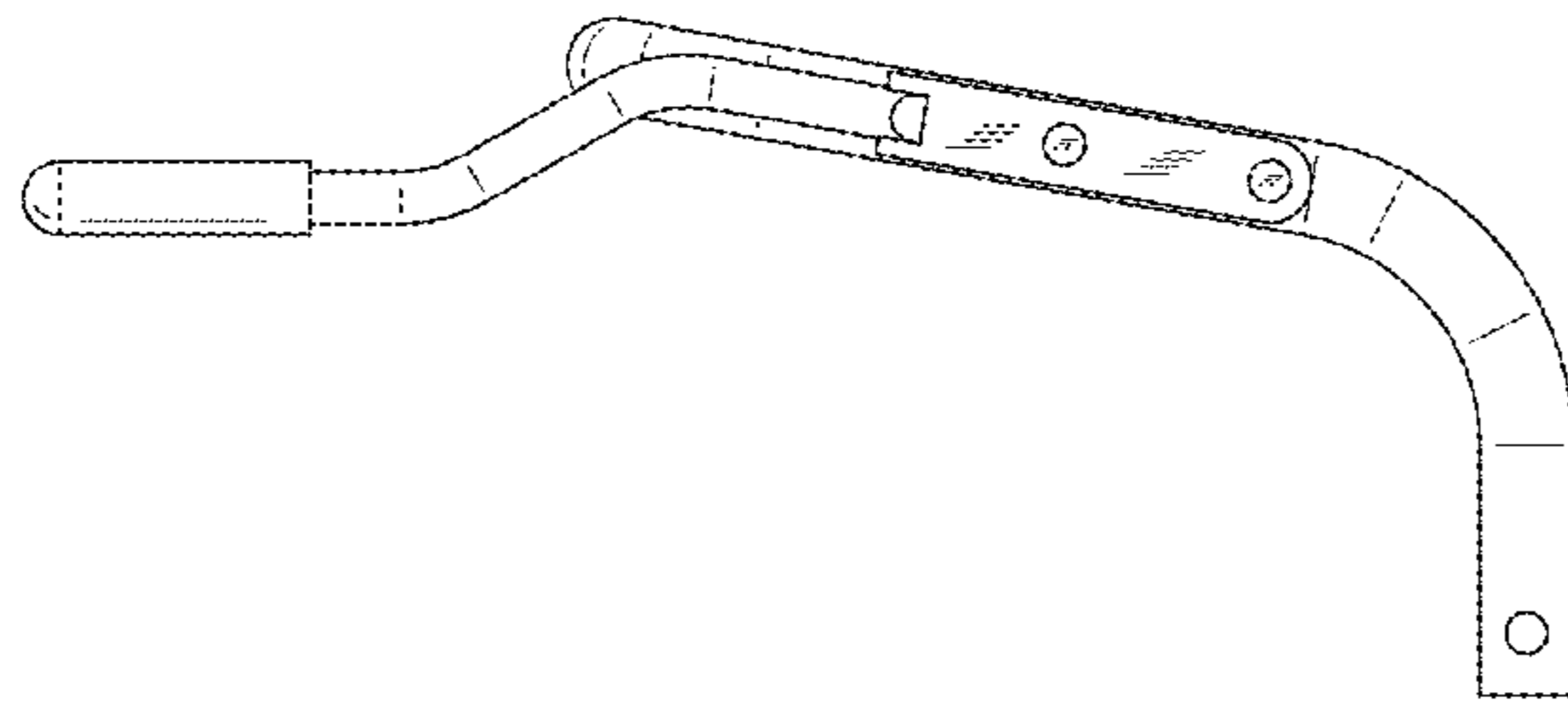

FIG.4

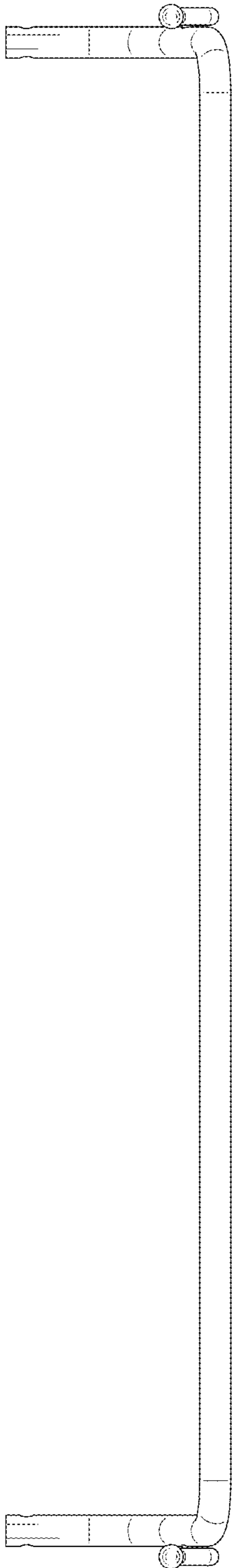

FIG. 6

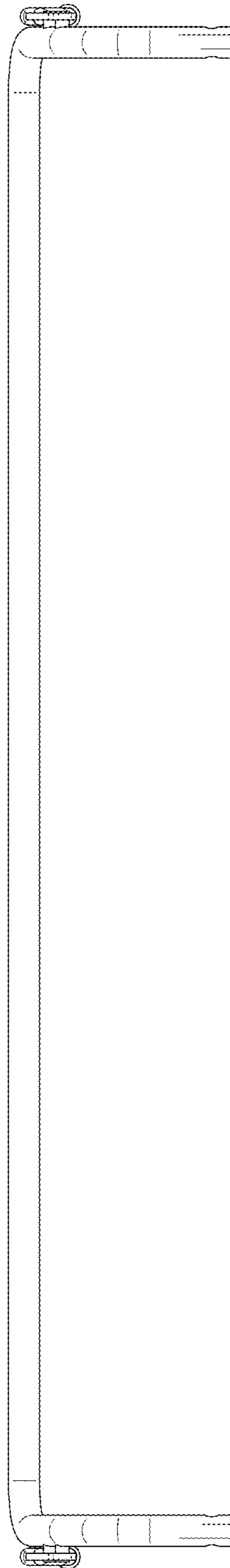

FIG. 7

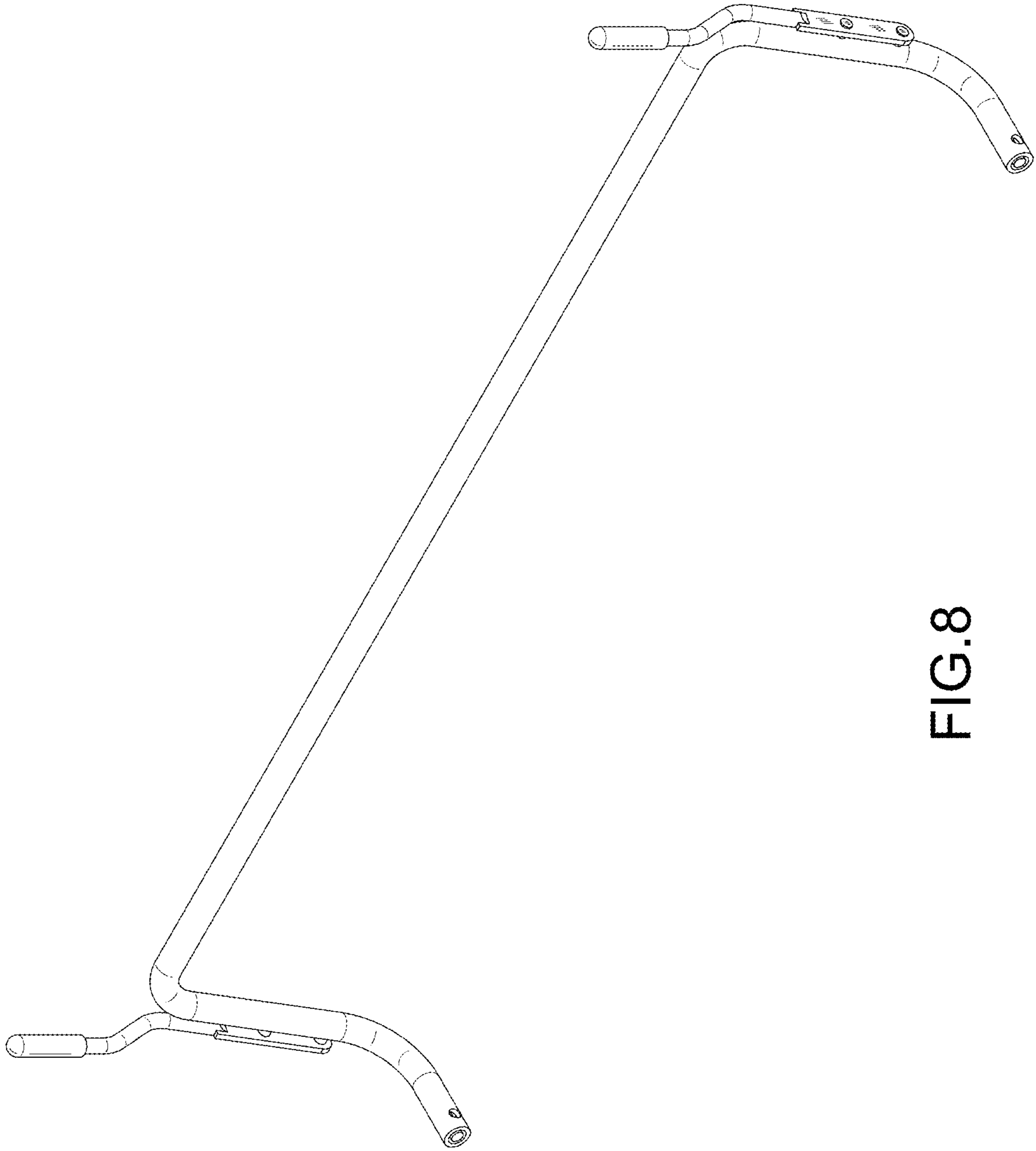

FIG. 8

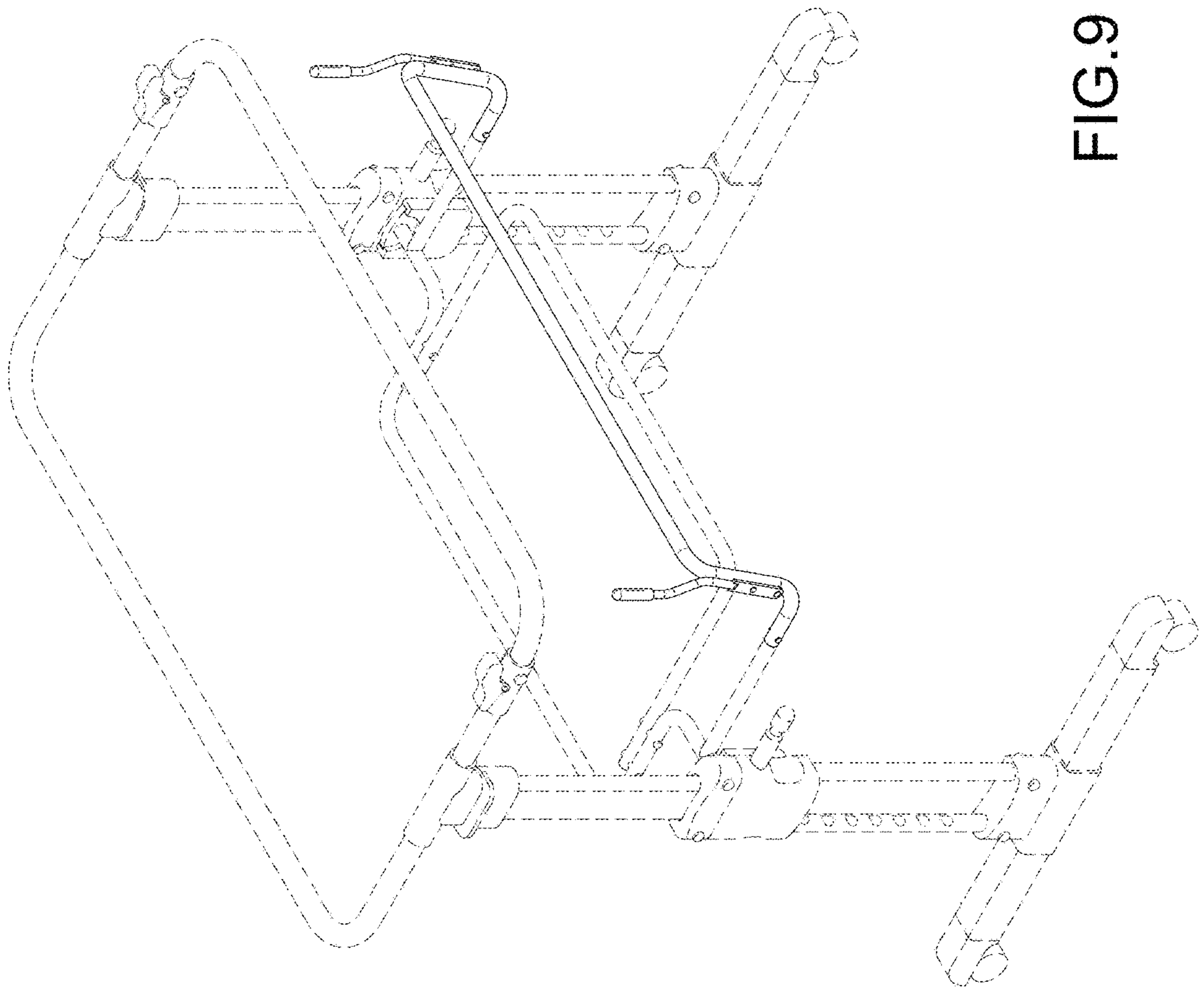

FIG. 9