



US00D913006S

(12) **United States Design Patent** (10) **Patent No.:** **US D913,006 S**
Li (45) **Date of Patent:** **** Mar. 16, 2021**

(54) **CHAIR**
(71) Applicant: **39F USA INC**, Rancho Cucamonga, CA (US)
(72) Inventor: **Yuehai Li**, Rancho Cucamonga, CA (US)
(**) Term: **15 Years**
(21) Appl. No.: **29/711,787**
(22) Filed: **Nov. 2, 2019**
(51) **LOC (13) Cl.** **06-01**
(52) **U.S. Cl.**
USPC **D6/375**
(58) **Field of Classification Search**
USPC D6/344, 367, 368, 373, 375, 380, 362, D6/370, 379, 716, 716.1, 716.4, 334, 360, D6/366, 369, 372, 374, 376
CPC A47C 4/48; A47C 3/12; A47C 1/00; A47C 1/0246; A47C 1/024; A47C 3/00; A47C 3/029; A47C 3/027; A47C 3/02; A47C 3/04; A47C 3/20; A47C 4/00; A47C 4/02; A47C 4/03; A47C 4/04; A47C 4/021; A47C 5/12; A47C 7/021; A47C 7/004; A47C 7/006; A47C 7/18; A47C 7/40; A47C 7/44; A47C 7/46; A47C 7/54; A47C 7/402; A47C 7/441; A47C 7/443; A47C 7/445; A47C 7/467; A47C 7/543; A47C 9/002; A47C 31/126; A47C 7/02; Y10S 297/01; B60N 2/02; A63G 9/10; A63B 26/00; A63B 26/003; A63B 2225/62; A63B 2210/50; A63B 21/1609; A47D 13/10
See application file for complete search history.

3,408,106 A * 10/1968 Bolling A47C 5/12 297/452.14
3,521,929 A * 7/1970 Pearson A47C 7/02 297/452.14
3,841,704 A * 10/1974 Platner A47C 3/12 297/452.55
D550,465 S * 9/2007 Bouroullec D6/334
D582,173 S * 12/2008 Dordoni D6/369
D596,864 S * 7/2009 Bergmann D6/369
D607,225 S * 1/2010 Bauchet D6/375
D656,755 S * 4/2012 Wanders D6/375
D664,381 S * 7/2012 Kubryk D6/716
D789,101 S * 6/2017 Morrison D6/334
D799,873 S * 10/2017 Swy D6/716
D799,874 S * 10/2017 Swy D6/716
D802,310 S * 11/2017 Rockwell D6/334
D807,066 S * 1/2018 Vance D6/334
D808,182 S * 1/2018 Baron D6/334
D815,449 S * 4/2018 Hannoosh D6/374
D858,121 S * 9/2019 Natuzzi D6/334

(Continued)

Primary Examiner — Kevin K Rudzinski
Assistant Examiner — Paul D Bohannon
(74) Attorney, Agent, or Firm — Feng Qian

(57) **CLAIM**

The ornamental design for a chair, as shown and described.

DESCRIPTION

FIG. 1 is a front perspective view of a chair showing my new design;
FIG. 2 is a front elevation view thereof;
FIG. 3 is a rear elevation view thereof;
FIG. 4 is a left-side elevation view thereof;
FIG. 5 is a right-side elevation view thereof;
FIG. 6 is a top plan view thereof; and,
FIG. 7 is a bottom plan view thereof.
The broken lines shown in the drawings are for the purpose of illustrating portions of the article, and form no part of the claimed design.

(56) **References Cited**

U.S. PATENT DOCUMENTS

D181,945 S * 1/1958 Saarinen D6/365
D187,525 S * 3/1960 Ihreborn D6/334

1 Claim, 7 Drawing Sheets

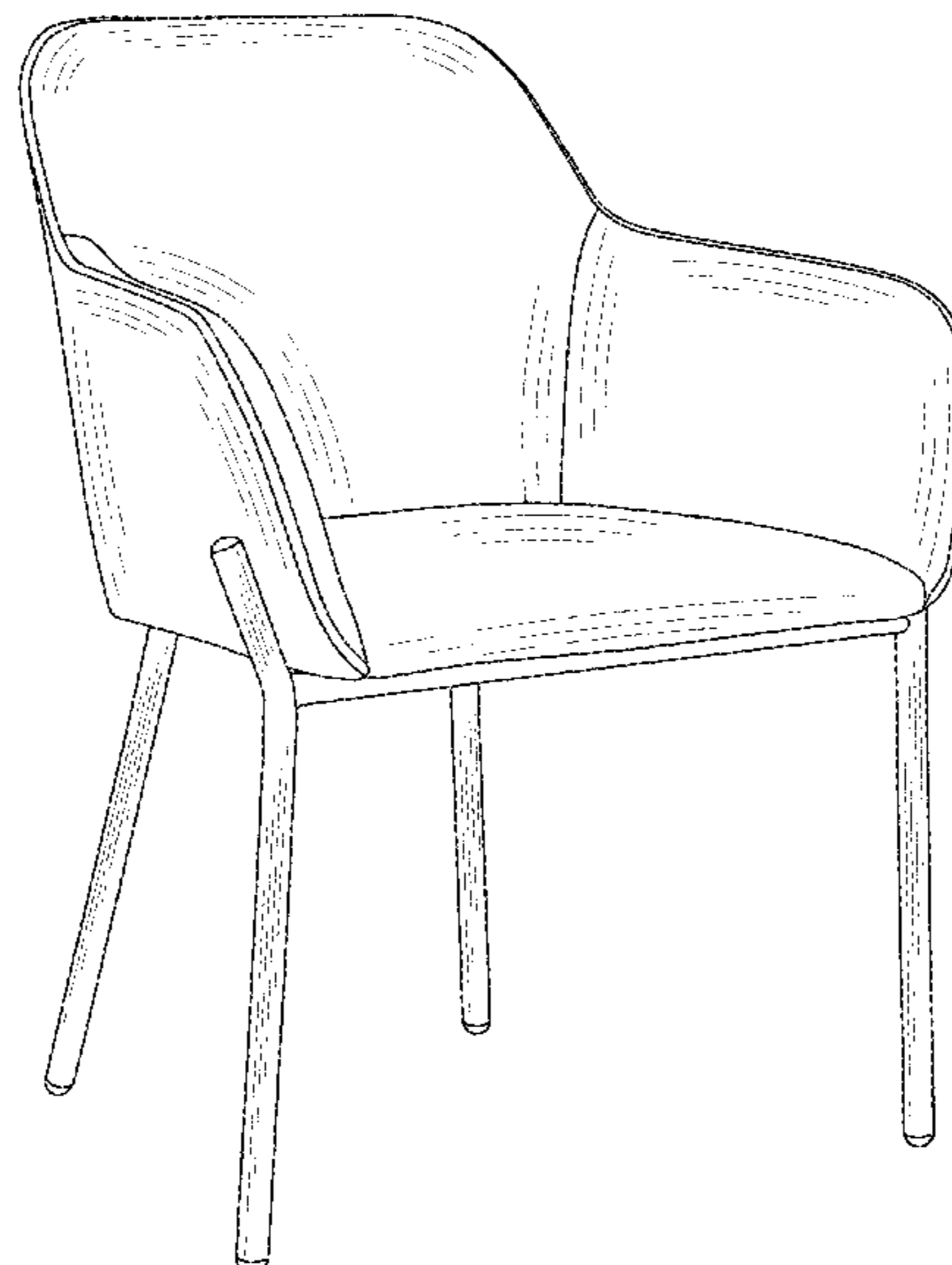

(56)

References Cited

U.S. PATENT DOCUMENTS

D858,122 S *	9/2019	Natuzzi	D6/334
D867,780 S *	11/2019	Krusin	D6/374
D871,788 S *	1/2020	Gori	D6/360
D876,116 S *	2/2020	Ji	D6/374
D899,799 S *	2/2020	Ji	D6/366
D882,971 S *	5/2020	Izawa	D6/334
D886,483 S *	6/2020	Li	D6/374
D886,484 S *	6/2020	Li	D6/374
D887,730 S *	6/2020	Furuland	D6/348

* cited by examiner

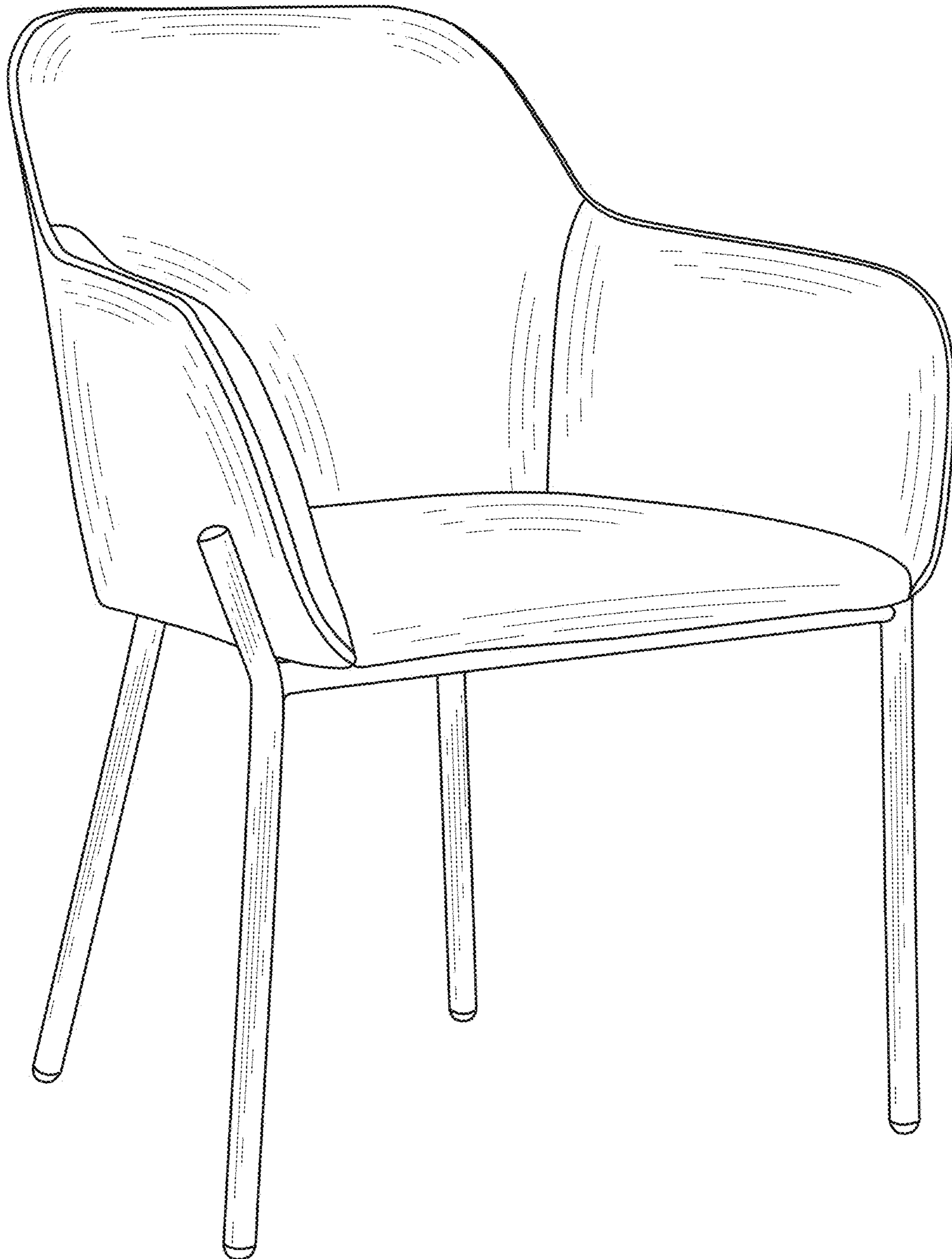

FIG. 1

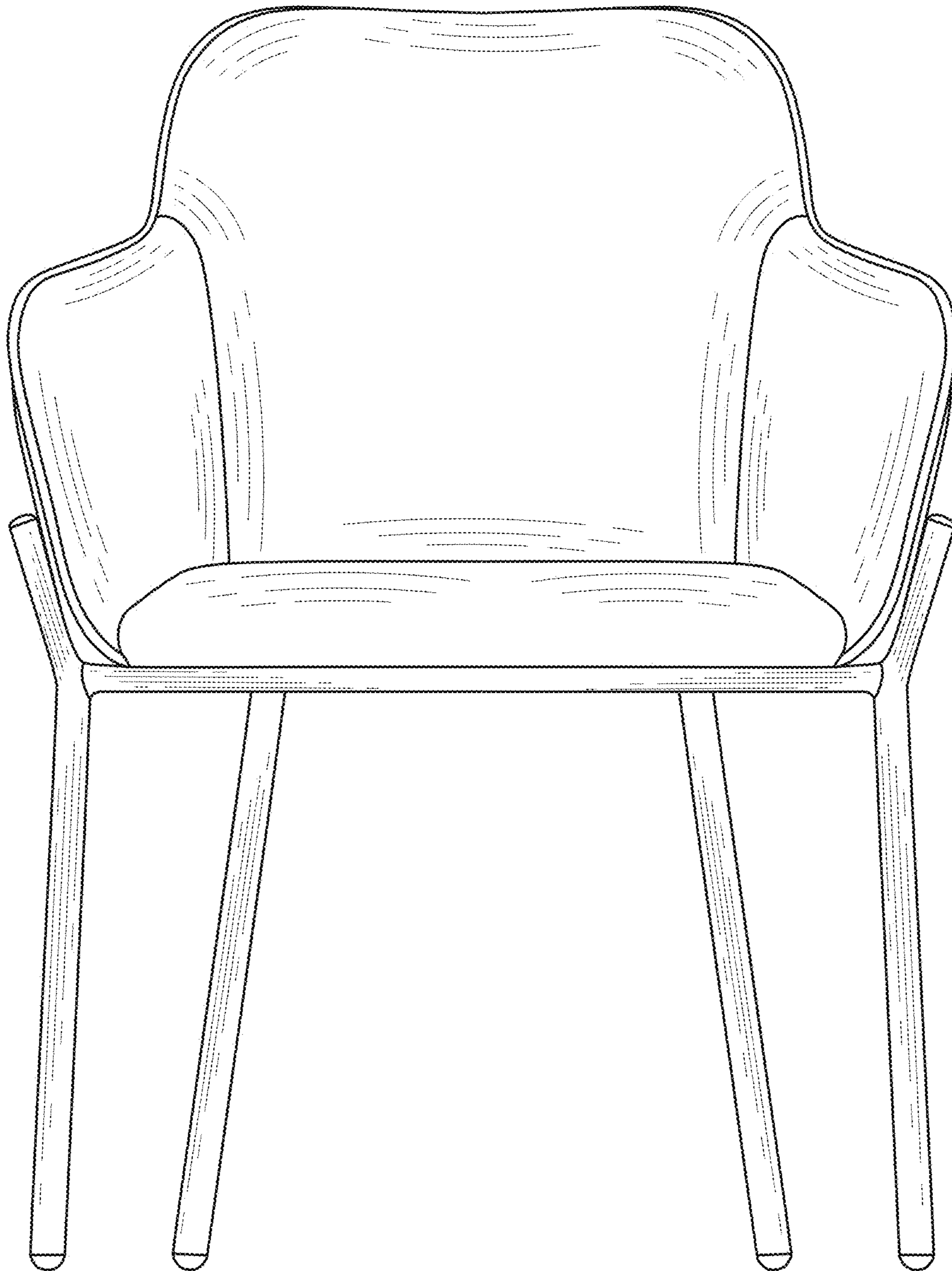

FIG. 2

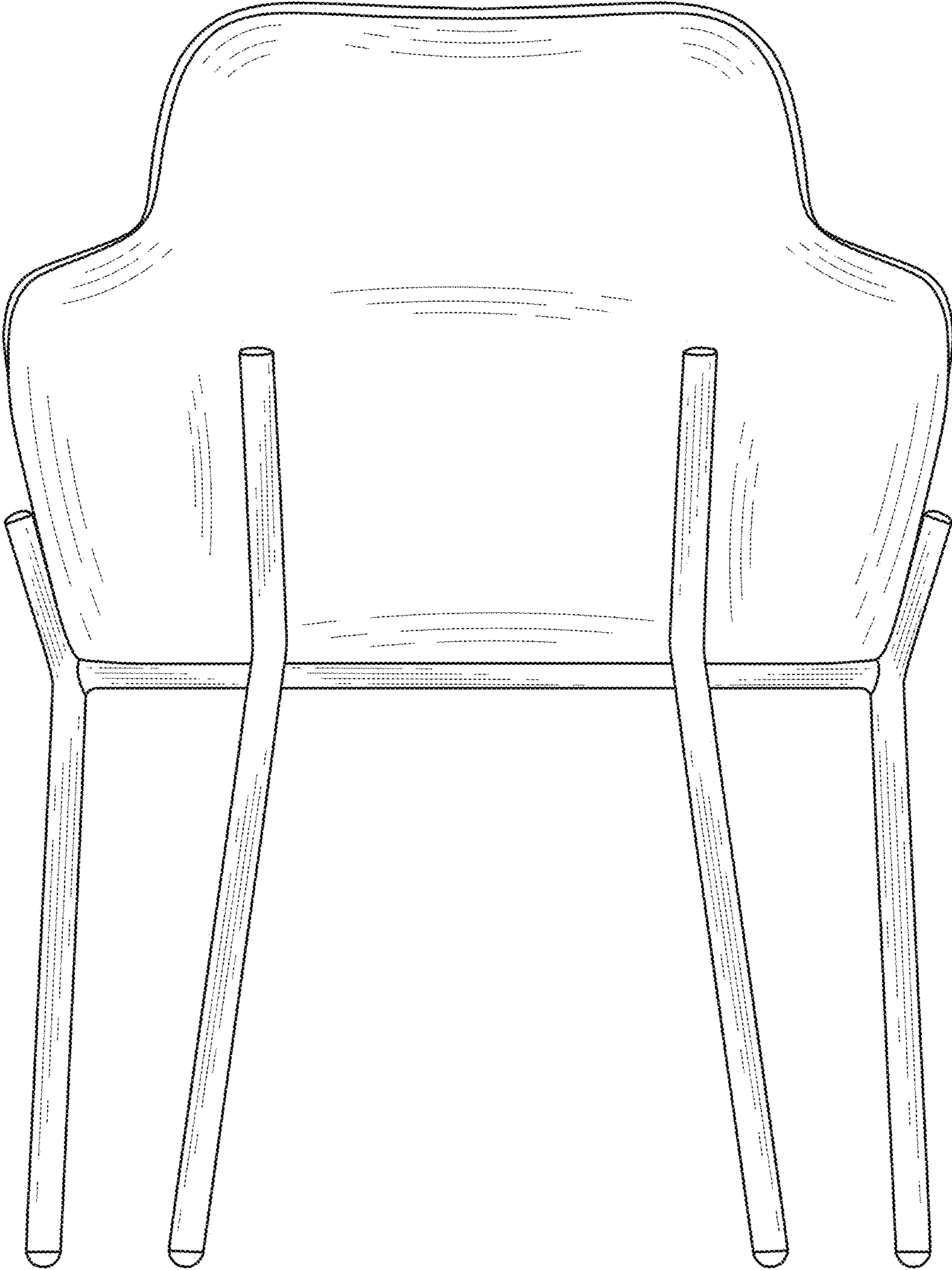

FIG. 3

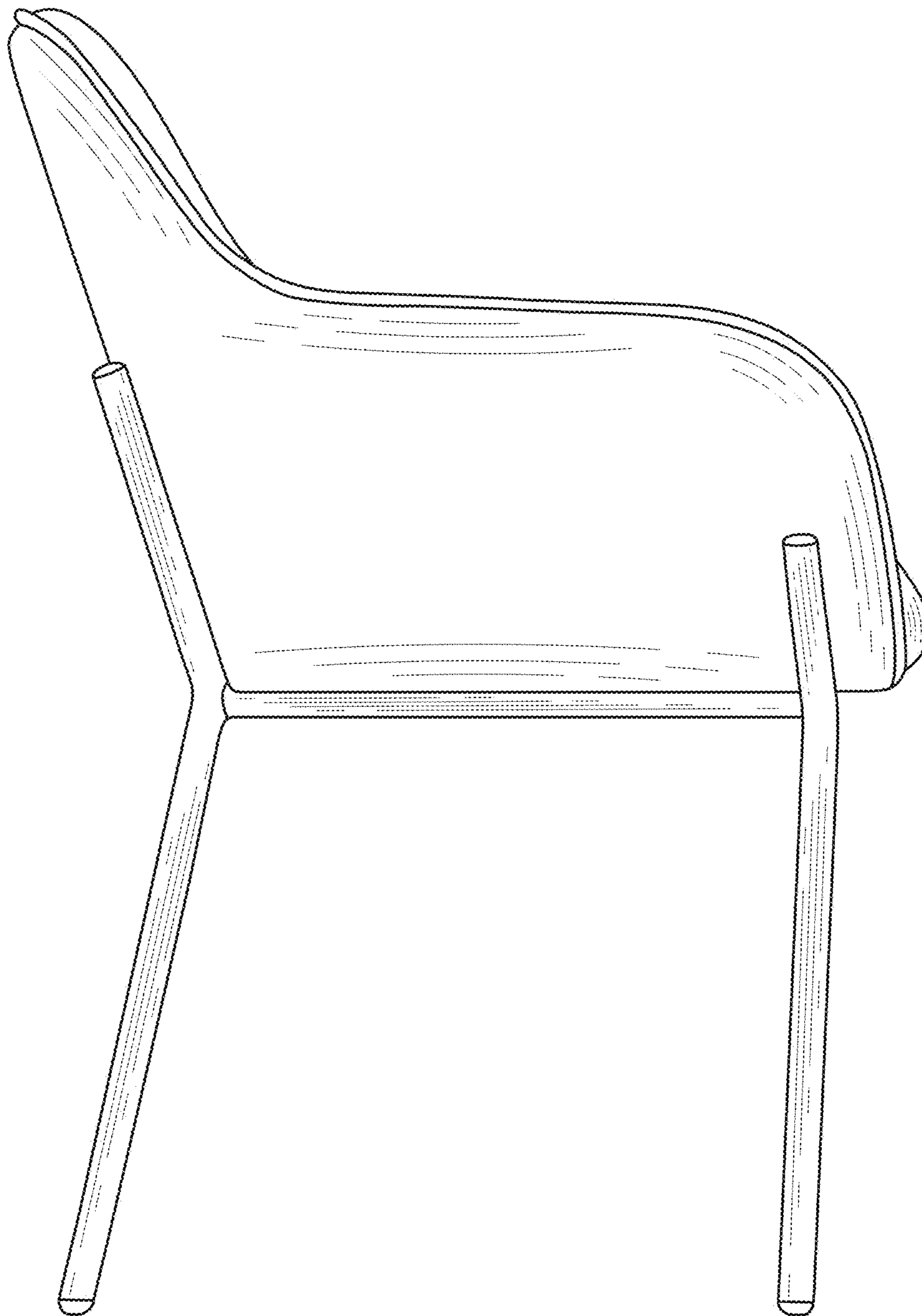

FIG. 4

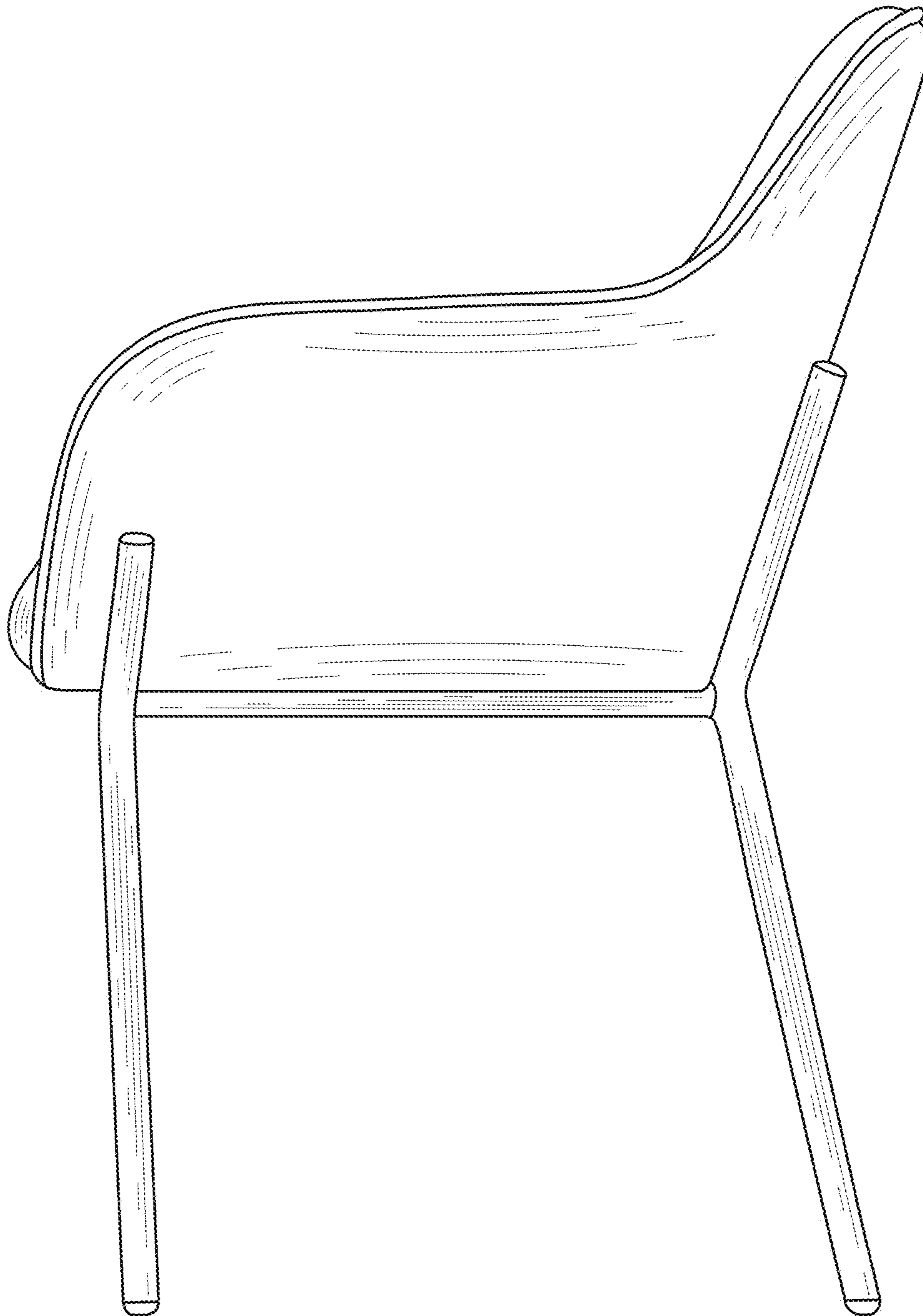

FIG. 5

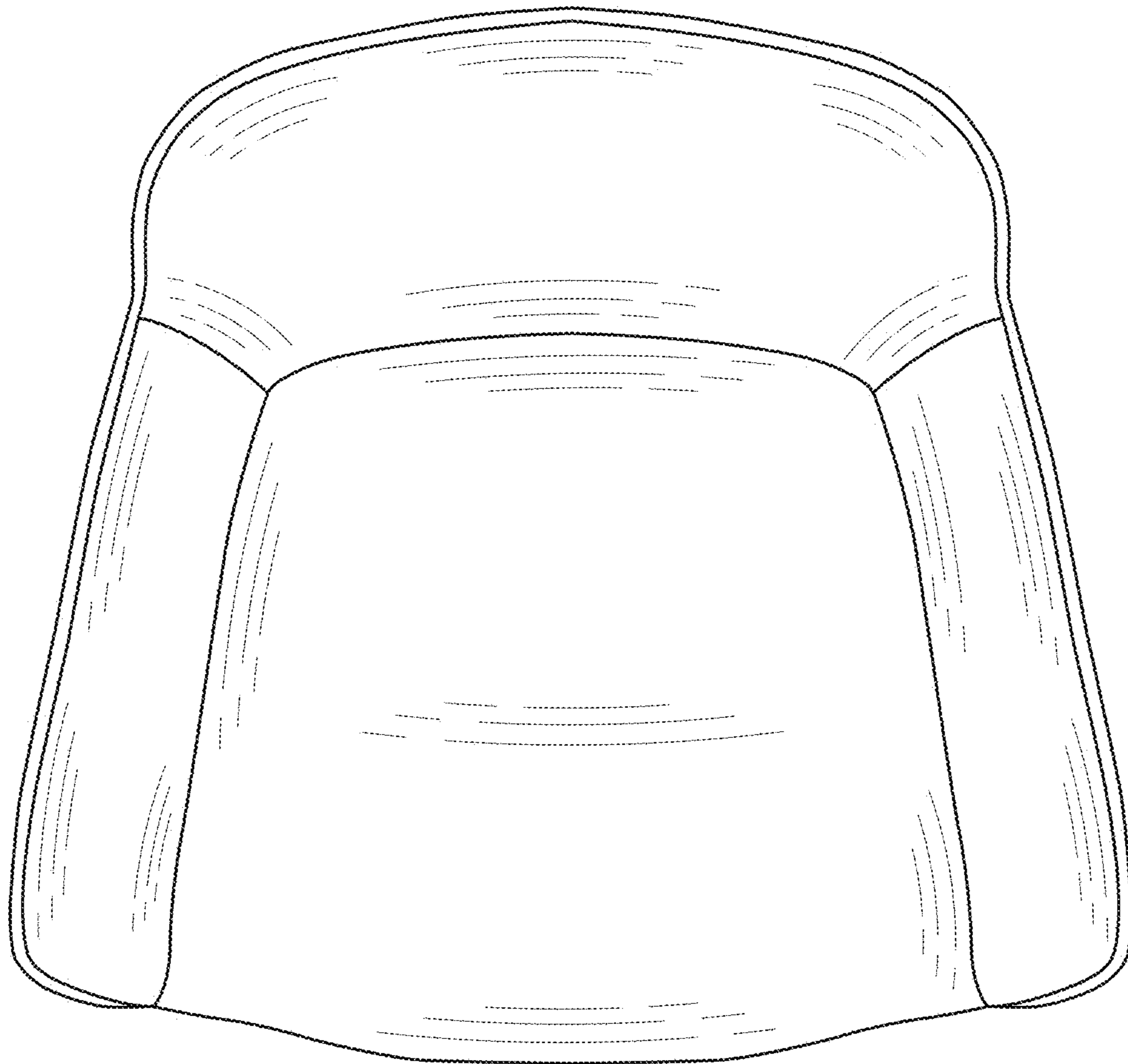

FIG. 6

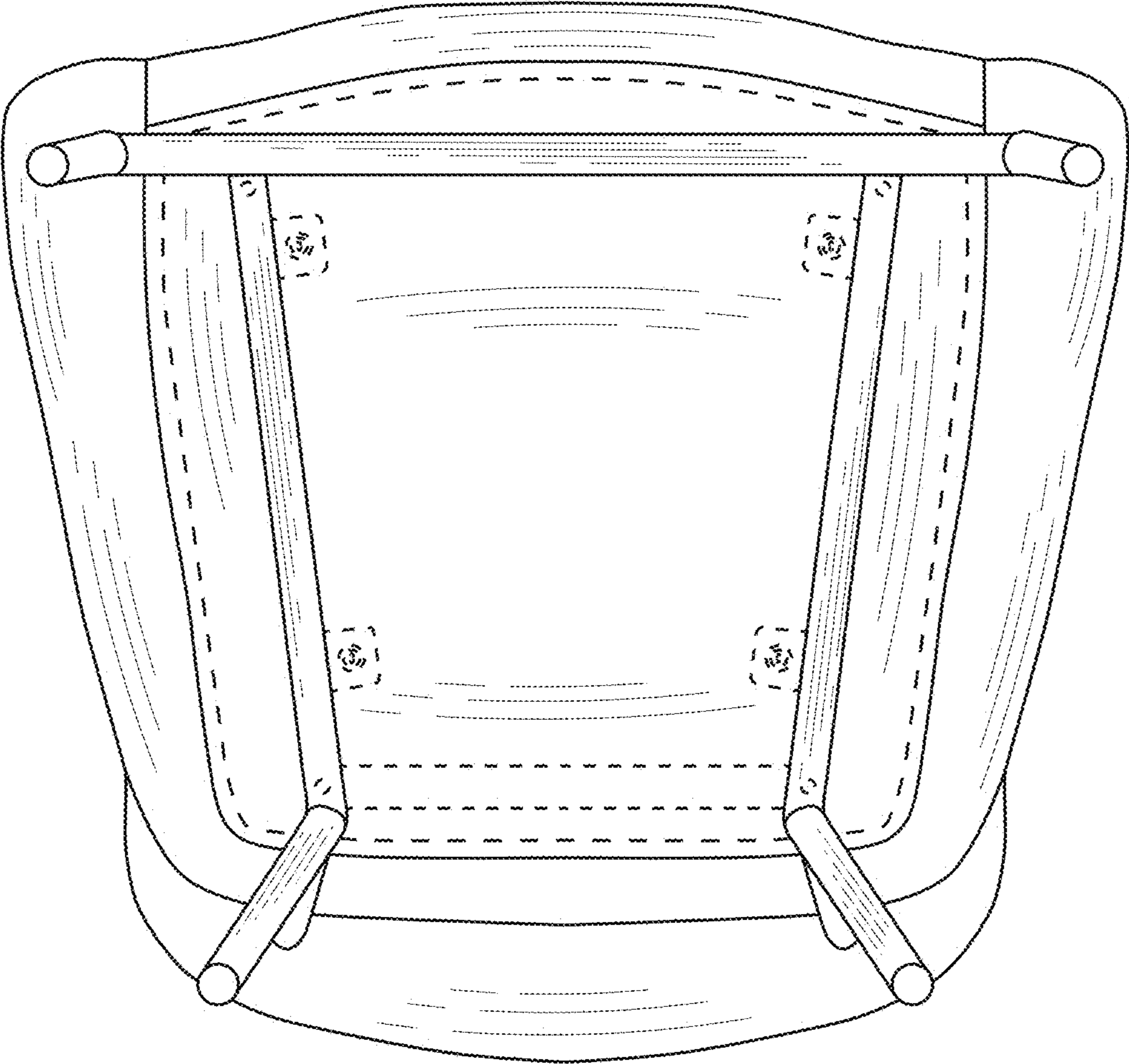

FIG. 7