



US00D912944S

(12) **United States Design Patent** (10) **Patent No.:** **US D912,944 S**
Bradley et al. (45) **Date of Patent:** **** Mar. 16, 2021**

(54) **SOCK STRAP**

(71) Applicants: **Kevin Bradley**, Briarcliff Manor, NY (US); **Lucie Bradley Fiserova**, Briarcliff Manor, NY (US)

(72) Inventors: **Kevin Bradley**, Briarcliff Manor, NY (US); **Lucie Bradley Fiserova**, Briarcliff Manor, NY (US)

(**) Term: **15 Years**

(21) Appl. No.: **29/646,085**

(22) Filed: **May 1, 2018**

(51) **LOC (13) Cl.** **02-01**

(52) **U.S. Cl.**
USPC **D2/859**

(58) **Field of Classification Search**
USPC D2/624, 627, 636, 702, 859; D24/190;
D3/224-227

(Continued)

(56) **References Cited**

U.S. PATENT DOCUMENTS

3,119,117 A * 1/1964 Grubman A41F 9/002
2/102
3,411,160 A * 11/1968 Le Roux A41F 17/04
2/232

(Continued)

Primary Examiner — Kevin K Rudzinski

Assistant Examiner — Clare Ann Gannon

(74) *Attorney, Agent, or Firm* — Leason Ellis LLP

(57) **CLAIM**

The ornamental design for a sock strap, as shown and described.

DESCRIPTION

FIG. 1 is a front perspective view of a sock strap showing our design in accordance with the first embodiment;

FIG. 2 is a front elevation view thereof;
FIG. 3 is a rear elevation view thereof;
FIG. 4 is a top plan view thereof;
FIG. 5 is a bottom plan view thereof;
FIG. 6 is a right side elevation view thereof;
FIG. 7 is a left side elevation view thereof;
FIG. 8 is a front perspective view of the sock strap in accordance with a second embodiment shown in a position of use with an environmental sock;
FIG. 9 is a front elevation view thereof;
FIG. 10 is a rear elevation view thereof;
FIG. 11 is a top plan view thereof;
FIG. 12 is a bottom plan view thereof;
FIG. 13 is a right side elevation view thereof;
FIG. 14 is a left side elevation view thereof;
FIG. 15 is a front perspective view thereof, shown in a position of use with a longer environmental sock;
FIG. 16 is a front elevation view thereof;
FIG. 17 is a rear elevation view thereof;
FIG. 18 is a top plan view thereof;
FIG. 19 is a bottom plan view thereof;
FIG. 20 is a right side elevation view thereof;
FIG. 21 is a left side elevation view thereof;
FIG. 22 is a front perspective view of the sock strap in accordance with a third embodiment;
FIG. 23 is a front elevation view thereof;
FIG. 24 is a rear elevation view thereof;
FIG. 25 is a top plan view thereof;
FIG. 26 is a bottom plan view thereof;
FIG. 27 is a right side elevation view thereof;
FIG. 28 is a left side elevation view thereof;
FIG. 29 is a front perspective view of the sock strap in accordance with a fourth embodiment shown in a position of use with an environmental sock;
FIG. 30 is a front elevation view thereof;
FIG. 31 is a rear elevation view thereof;
FIG. 32 is a top plan view thereof;
FIG. 33 is a bottom plan view thereof;
FIG. 34 is a right side elevation view thereof;
FIG. 35 is a left side elevation view thereof;
FIG. 36 is a front perspective view thereof, shown in a position of use with a longer environmental sock;
FIG. 37 is a front elevation view thereof;
FIG. 38 is a rear elevation view thereof;

(Continued)

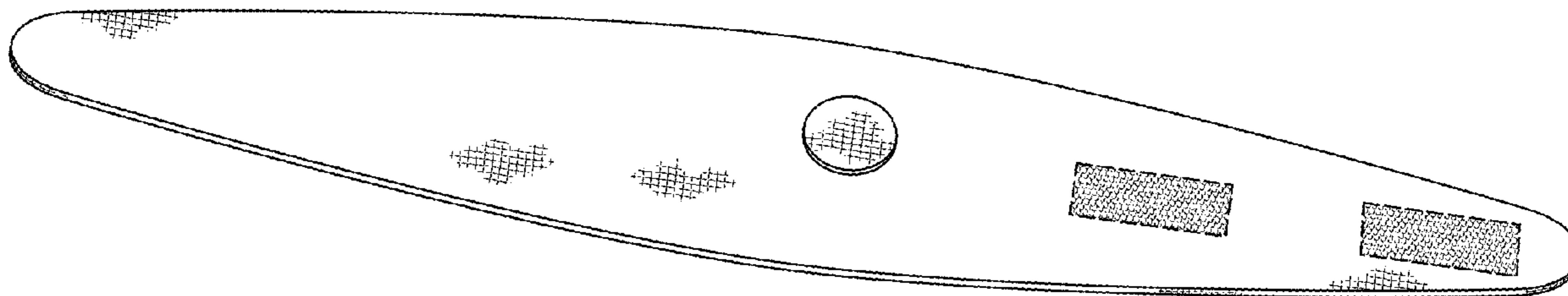

FIG. 39 is a top plan view thereof;
 FIG. 40 is a bottom plan view thereof;
 FIG. 41 is a right side elevation view thereof; and,
 FIG. 42 is a left side elevation view thereof.
 The broken lines used to depict the sock in FIGS. 8-21 and
 29-42 and stitching in FIGS. 1-3, 8-10, 15-17, 22-24, 29-31,
 and 36-38 illustrate environment and form no part of the
 claimed design.

1 Claim, 22 Drawing Sheets

(58) **Field of Classification Search**

CPC A41F 11/16; A41F 13/00; A41F 17/04;
 A41F 9/002; A41F 9/02; A41F 9/025;
 A61F 2007/0022; A61F 2007/0023; A61F
 2007/0025; A61F 2007/0026; A61F
 2007/0027; A61F 5/02; A61F 5/028;
 A61F 5/03; A61F 7/02; B60R 2022/008

See application file for complete search history.

(56)

References Cited

U.S. PATENT DOCUMENTS

D235,788	S	*	7/1975	Eberhardt	D21/662
5,377,360	A	*	1/1995	Fleitman	A41D 20/00 2/171
D405,534	S	*	2/1999	Hall	D24/190
D406,896	S	*	3/1999	Dancyger	D24/190
D533,774	S	*	12/2006	Harper	D9/434
D618,128	S	*	6/2010	Clark	A41F 9/002 D11/3
D710,570	S	*	8/2014	Zieth	A41D 27/08 D2/636
D841,935	S	*	3/2019	Dennard	D2/627
D876,656	S	*	2/2020	Campbell	A41D 20/00 D24/207
D901,022	S	*	11/2020	Jones	D24/190
2010/0200627	A1	*	8/2010	Shen	A45F 3/00 224/222
2016/0317341	A1	*	11/2016	Galvan	A61F 5/028
2018/0049493	A1	*	2/2018	Graves	A41D 27/08
2018/0360166	A1	*	12/2018	Lockwood	A41D 17/005

* cited by examiner

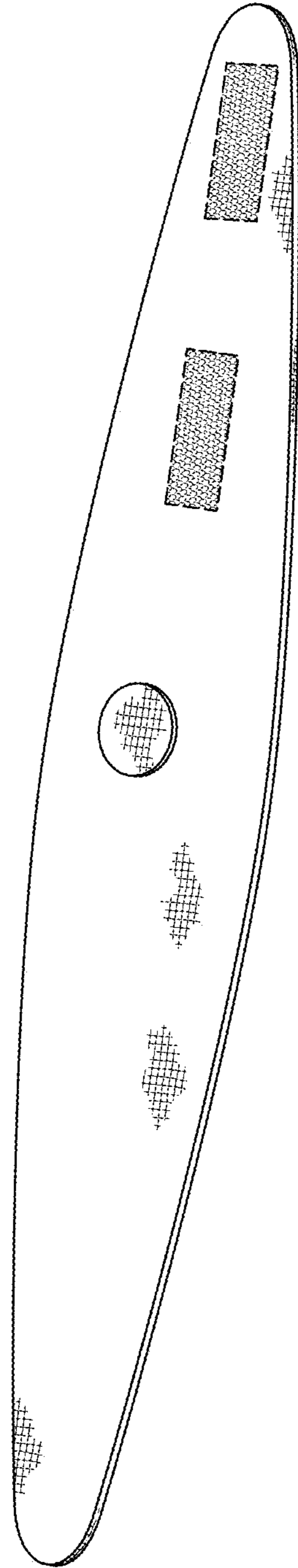

Fig. 1

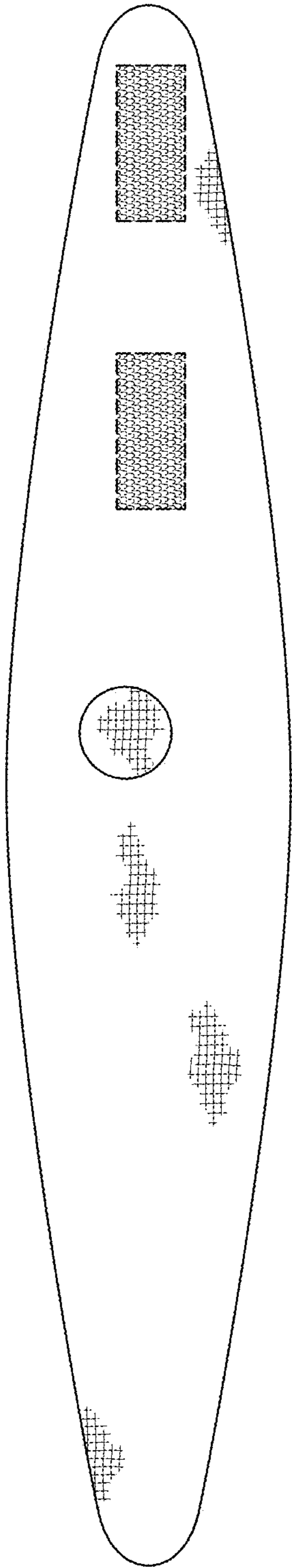

Fig. 2

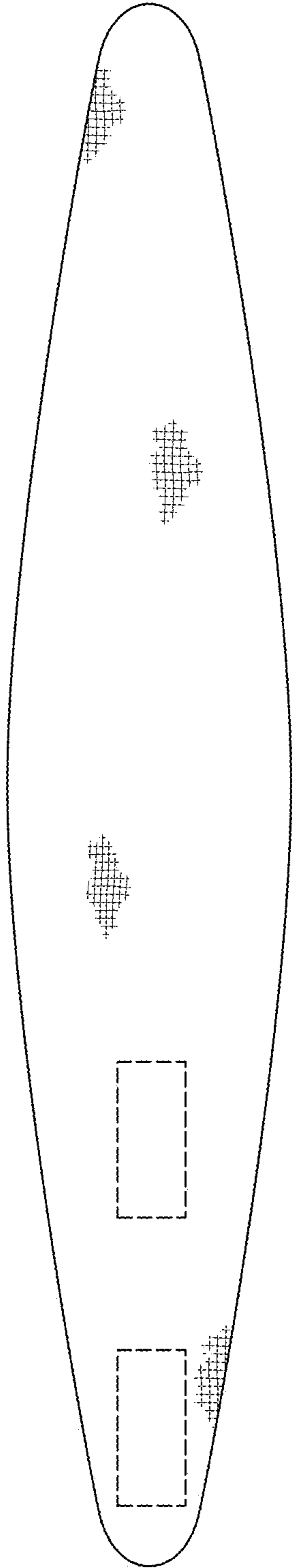

Fig. 3



Fig. 4



Fig. 5



Fig. 6



Fig. 7

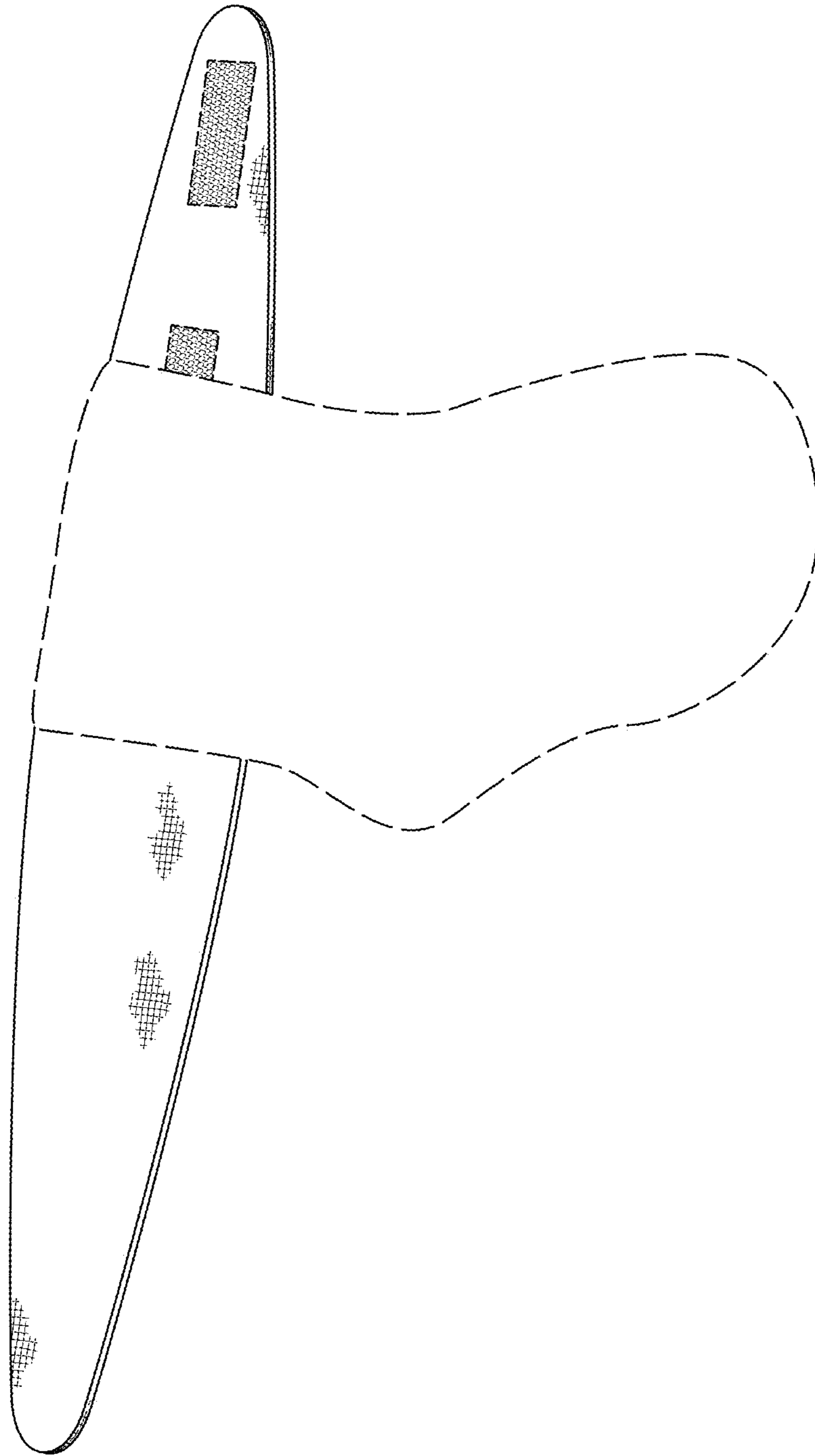

Fig. 8

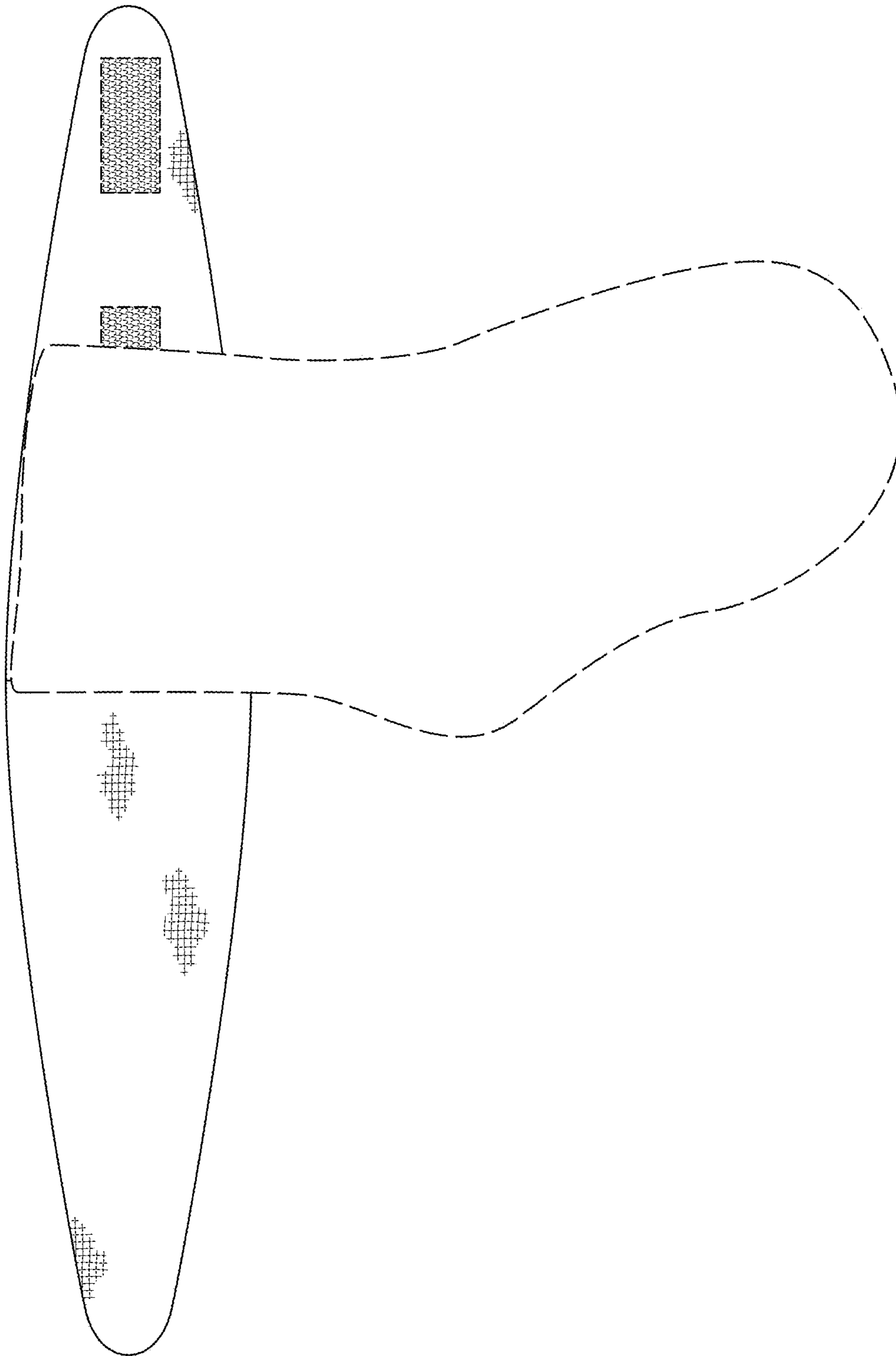

Fig. 9

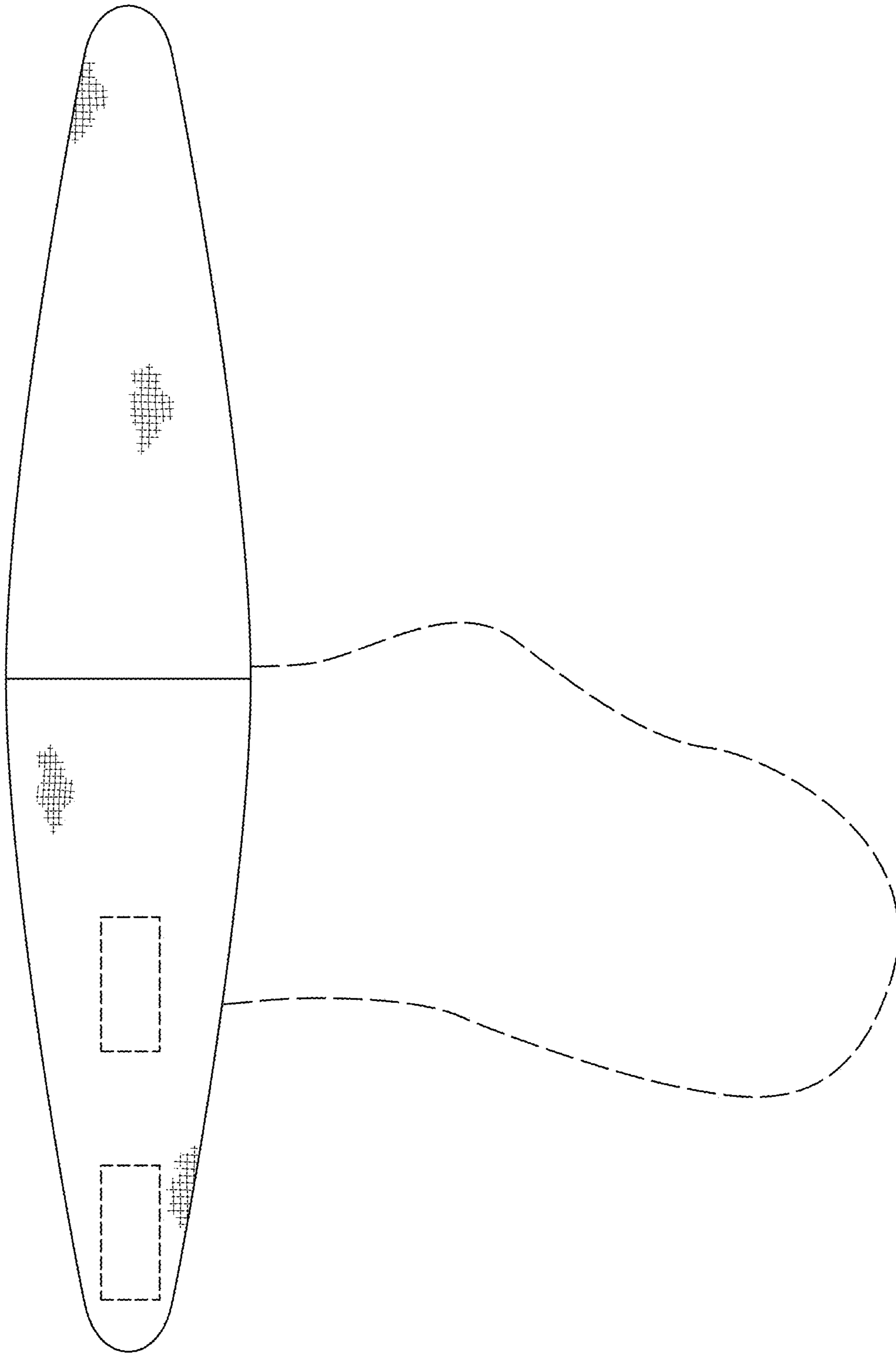

Fig. 10



Fig. 11



Fig. 12

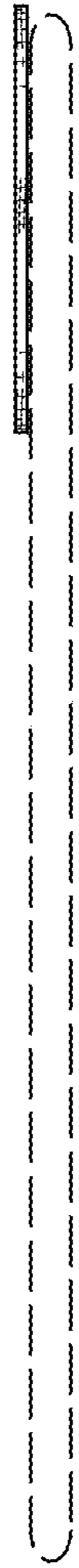

Fig. 13

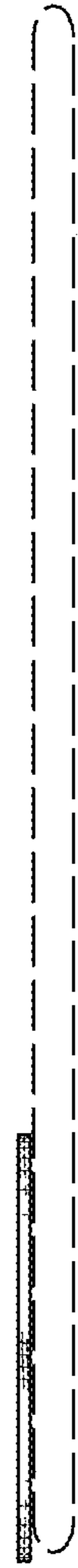

Fig. 14

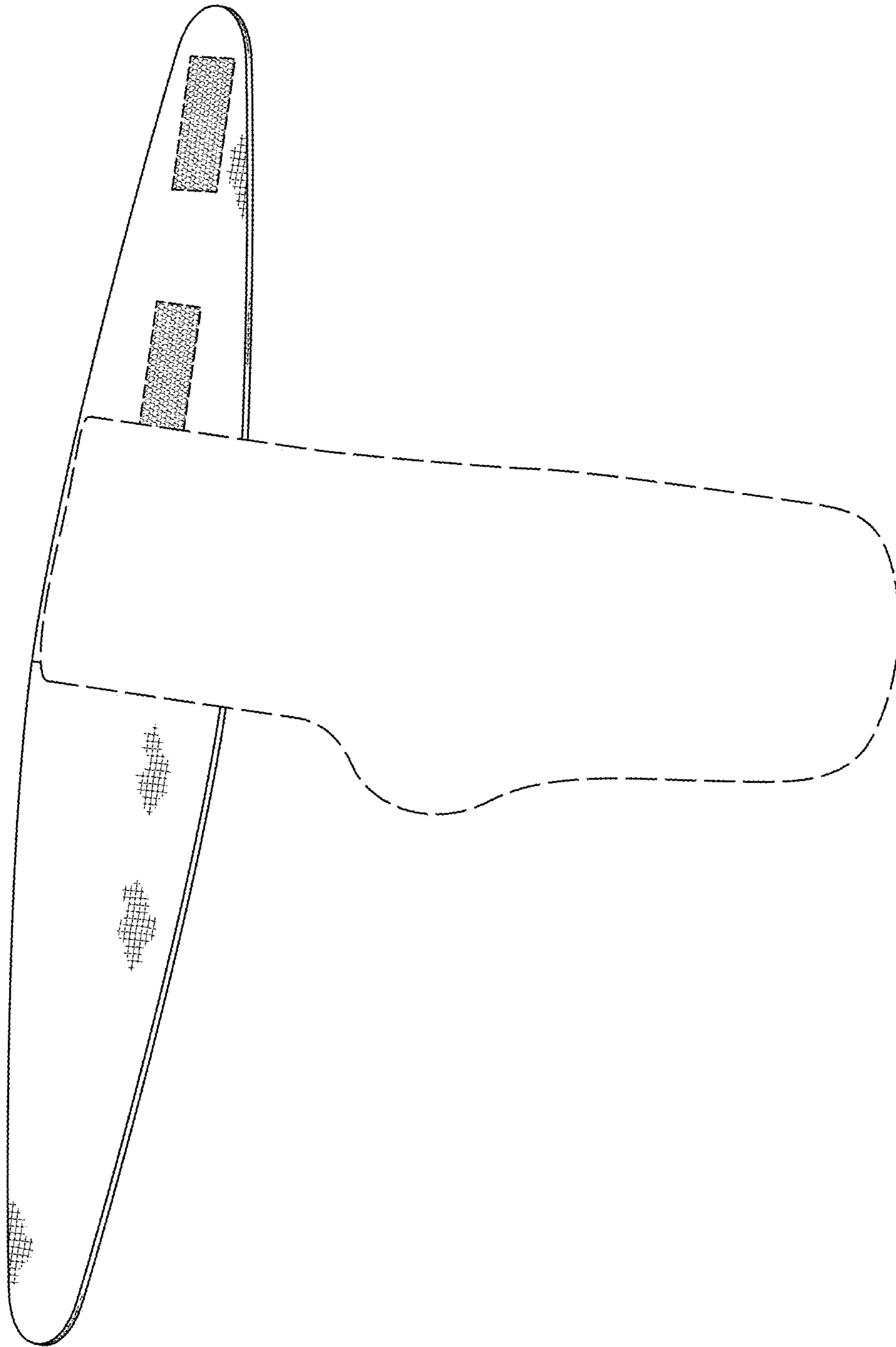

Fig. 15

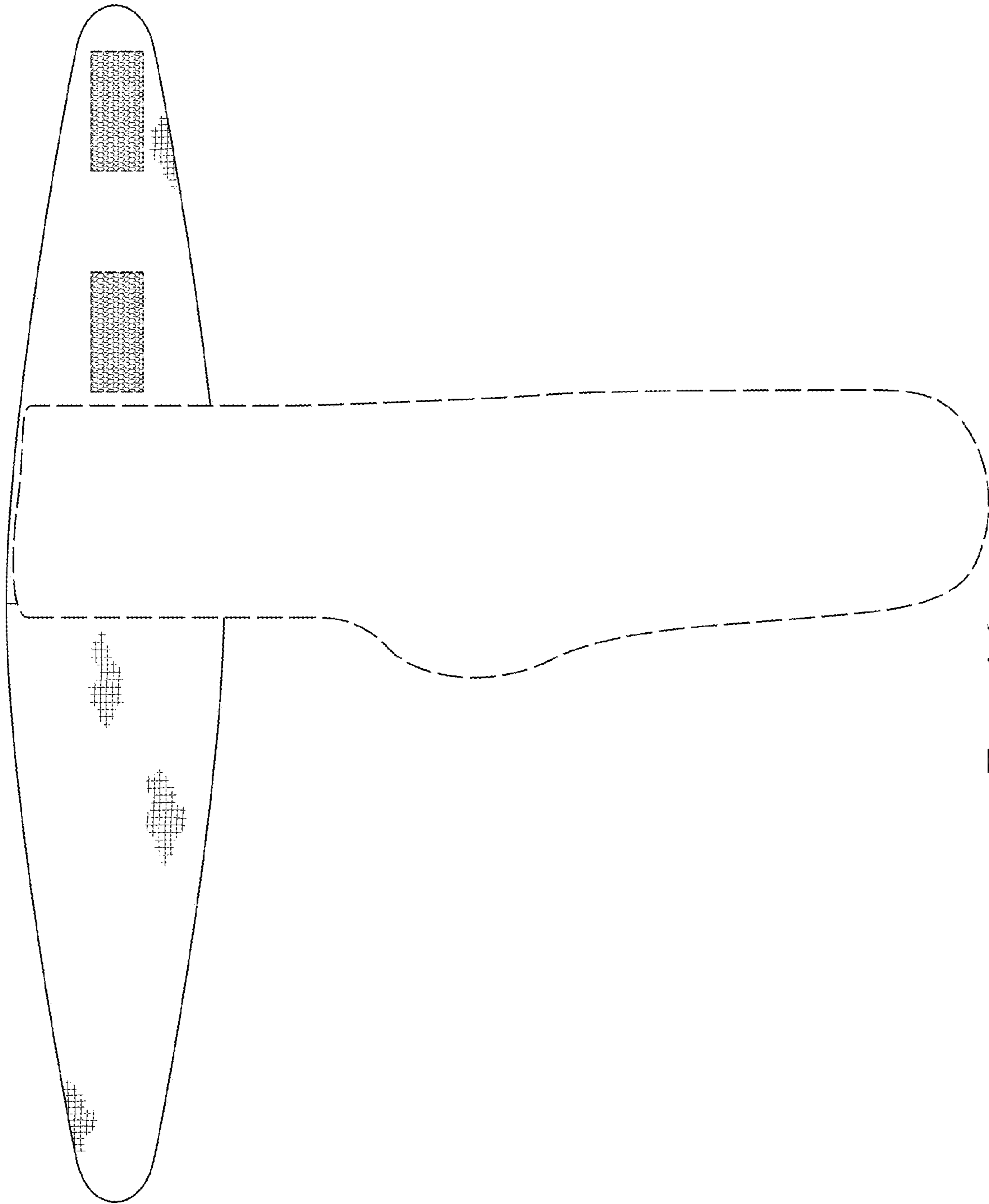

Fig. 16

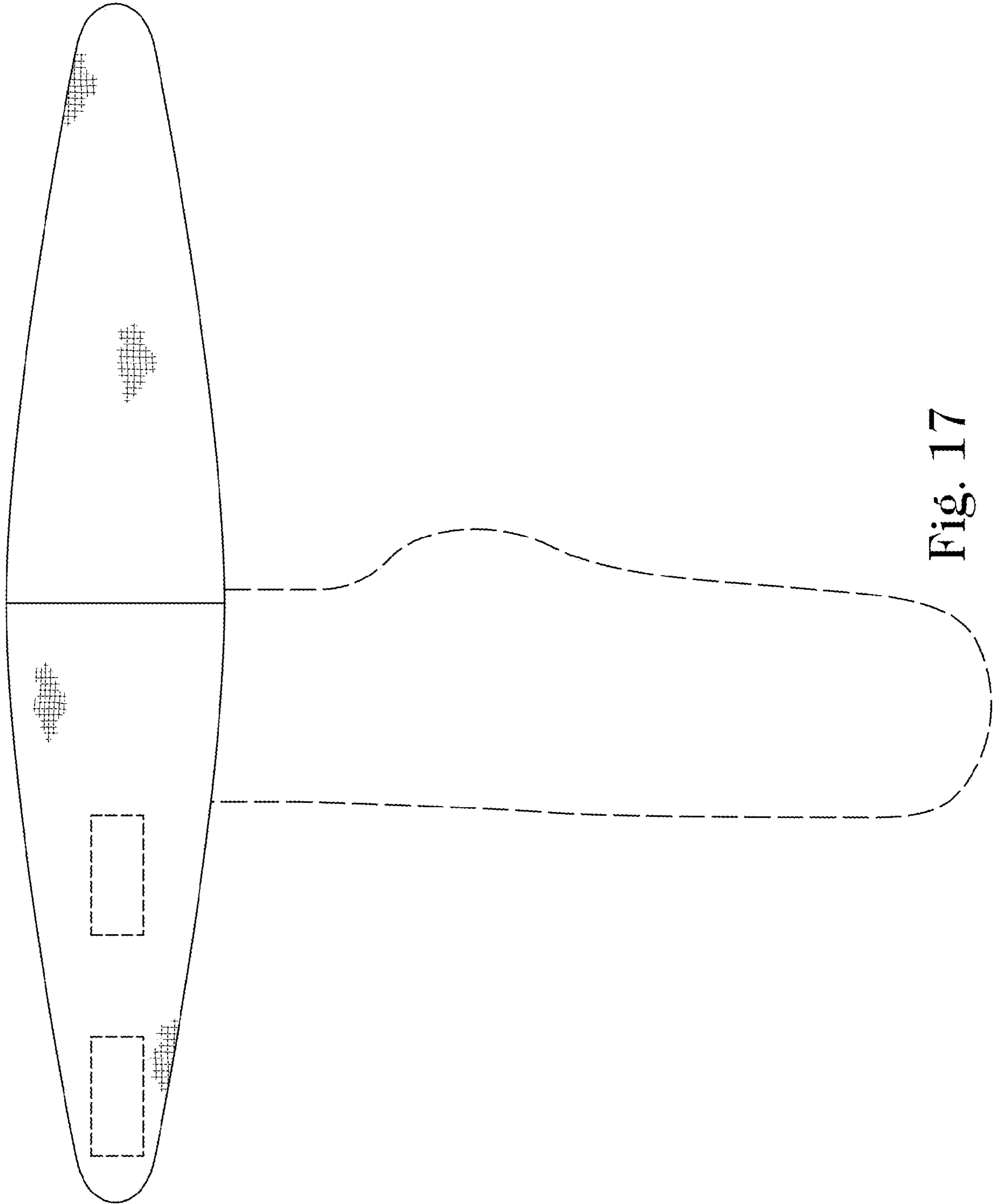

Fig. 17



Fig. 18

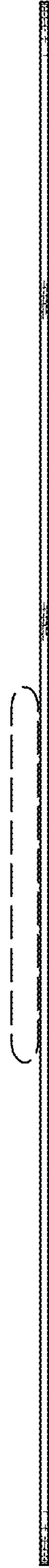

Fig. 19



Fig. 20

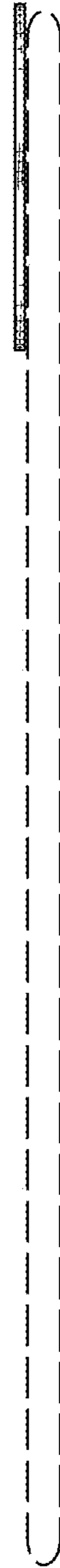

Fig. 21

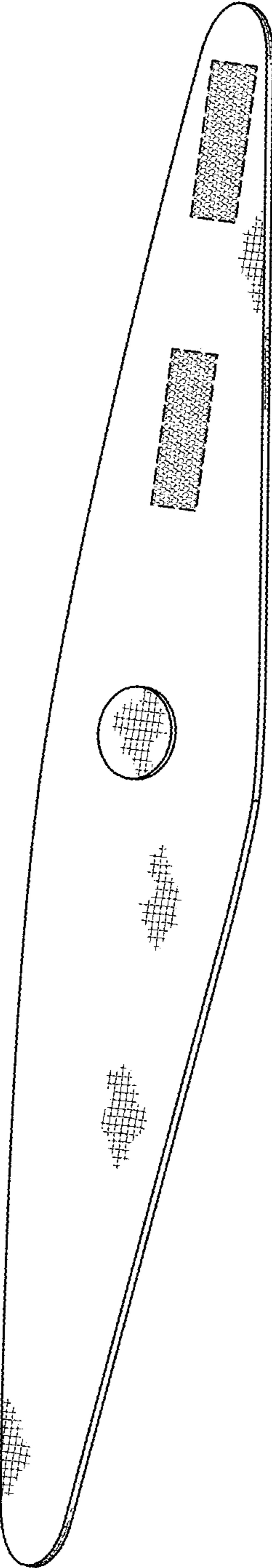

Fig. 22

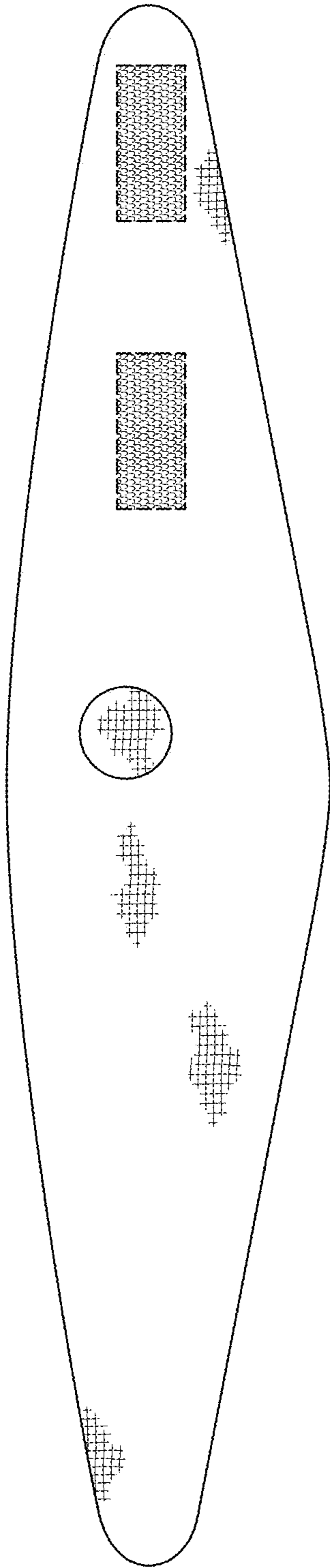

Fig. 23

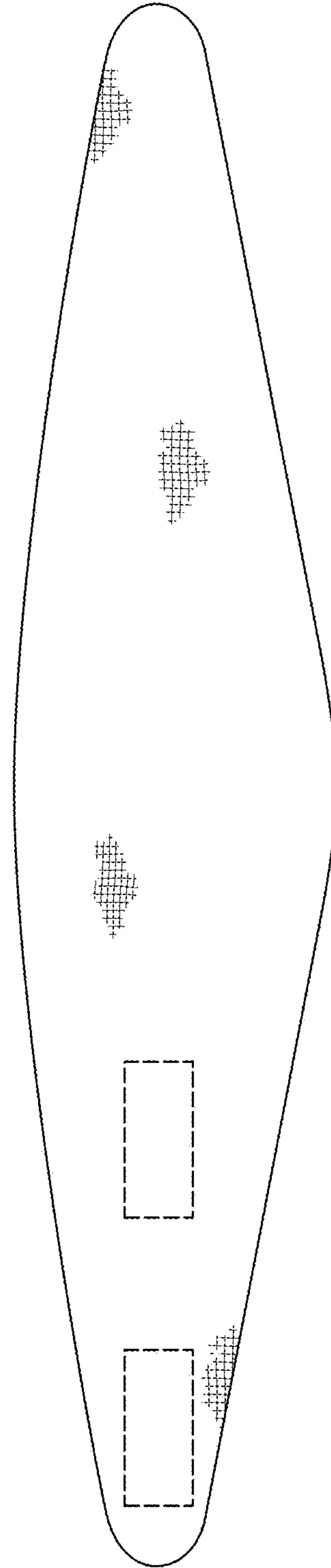

Fig. 24



Fig. 25

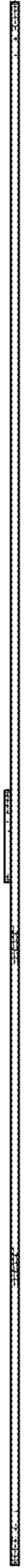

Fig. 26



Fig. 27



Fig. 28

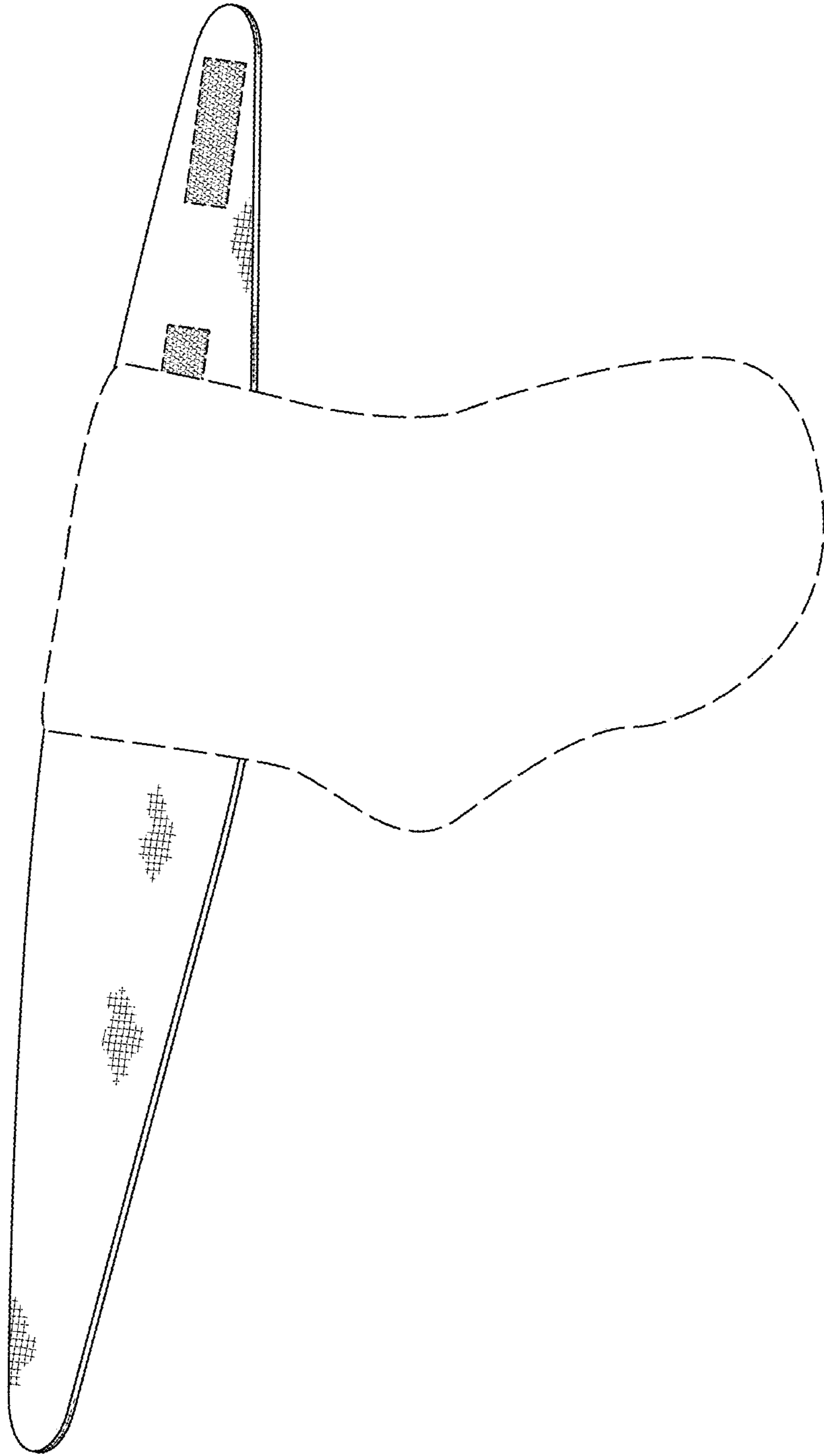

Fig. 29

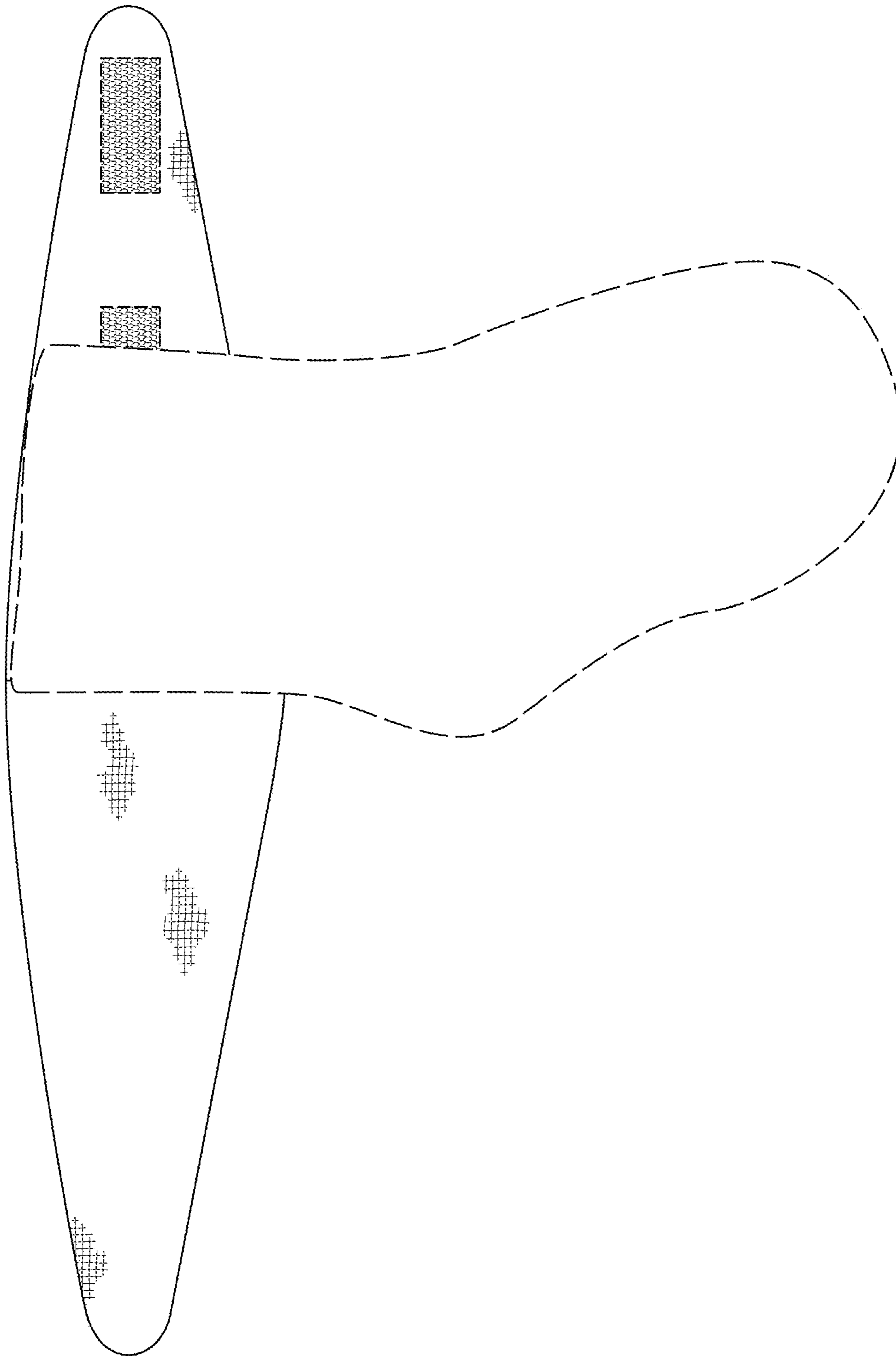

Fig. 30

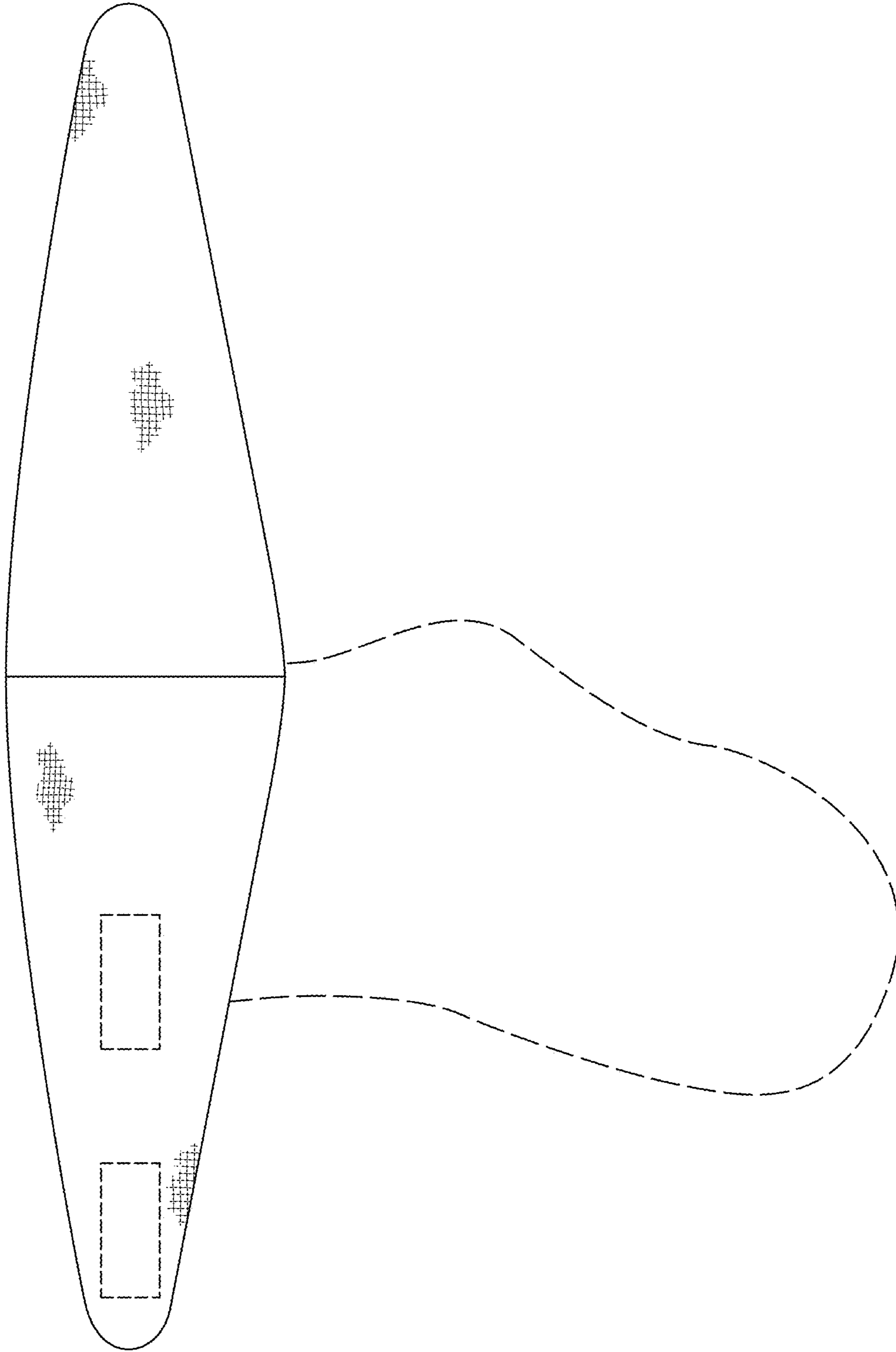

Fig. 31



Fig. 32

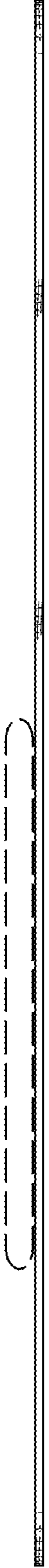

Fig. 33

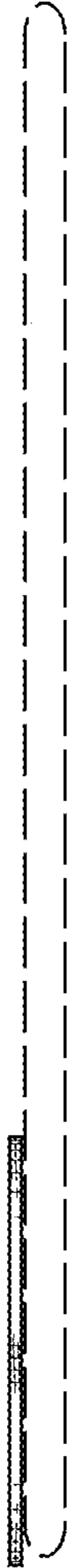

Fig. 34

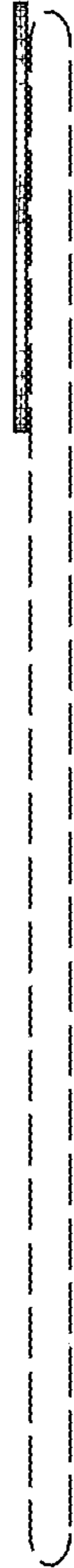

Fig. 35

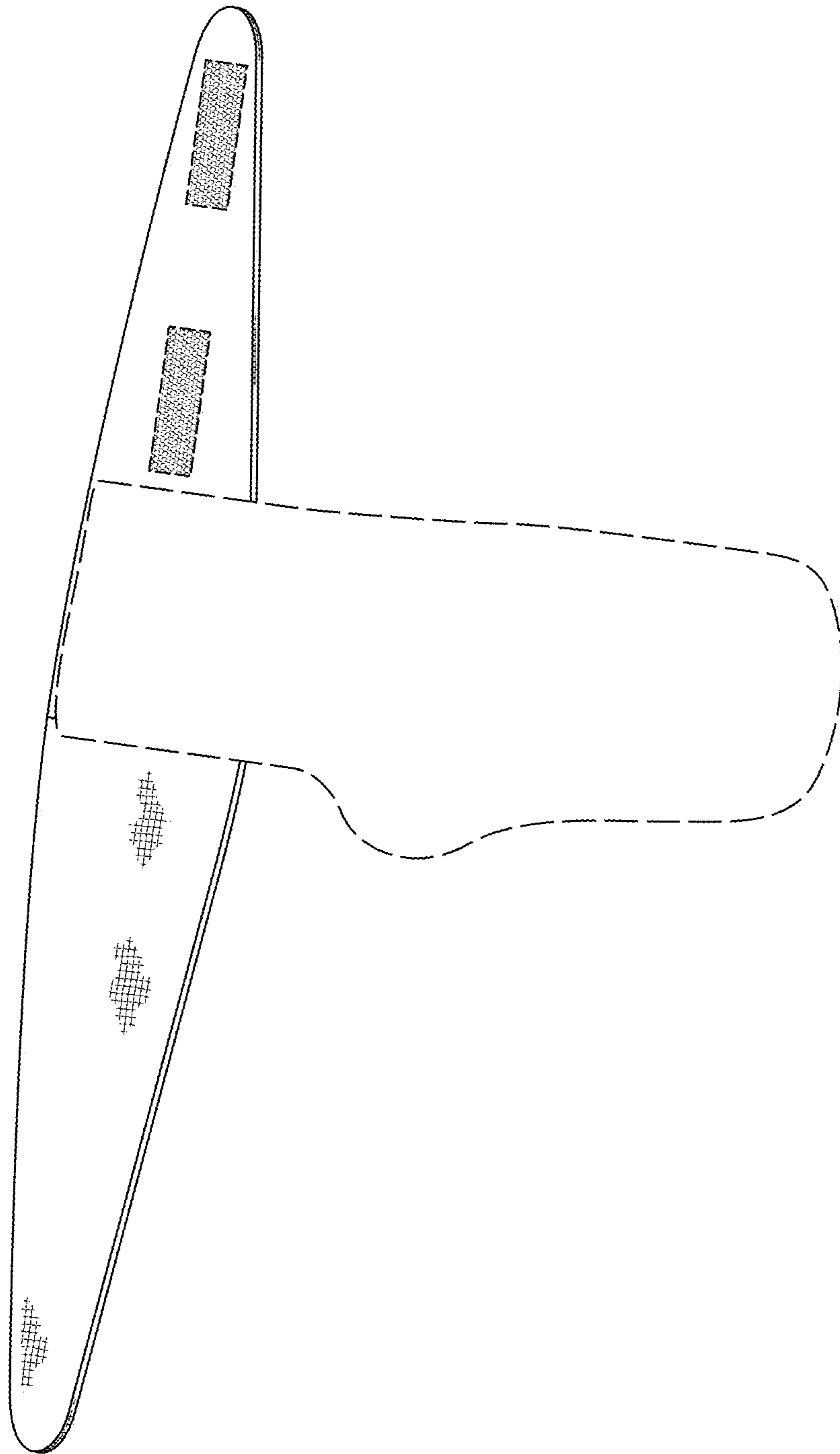

Fig. 36

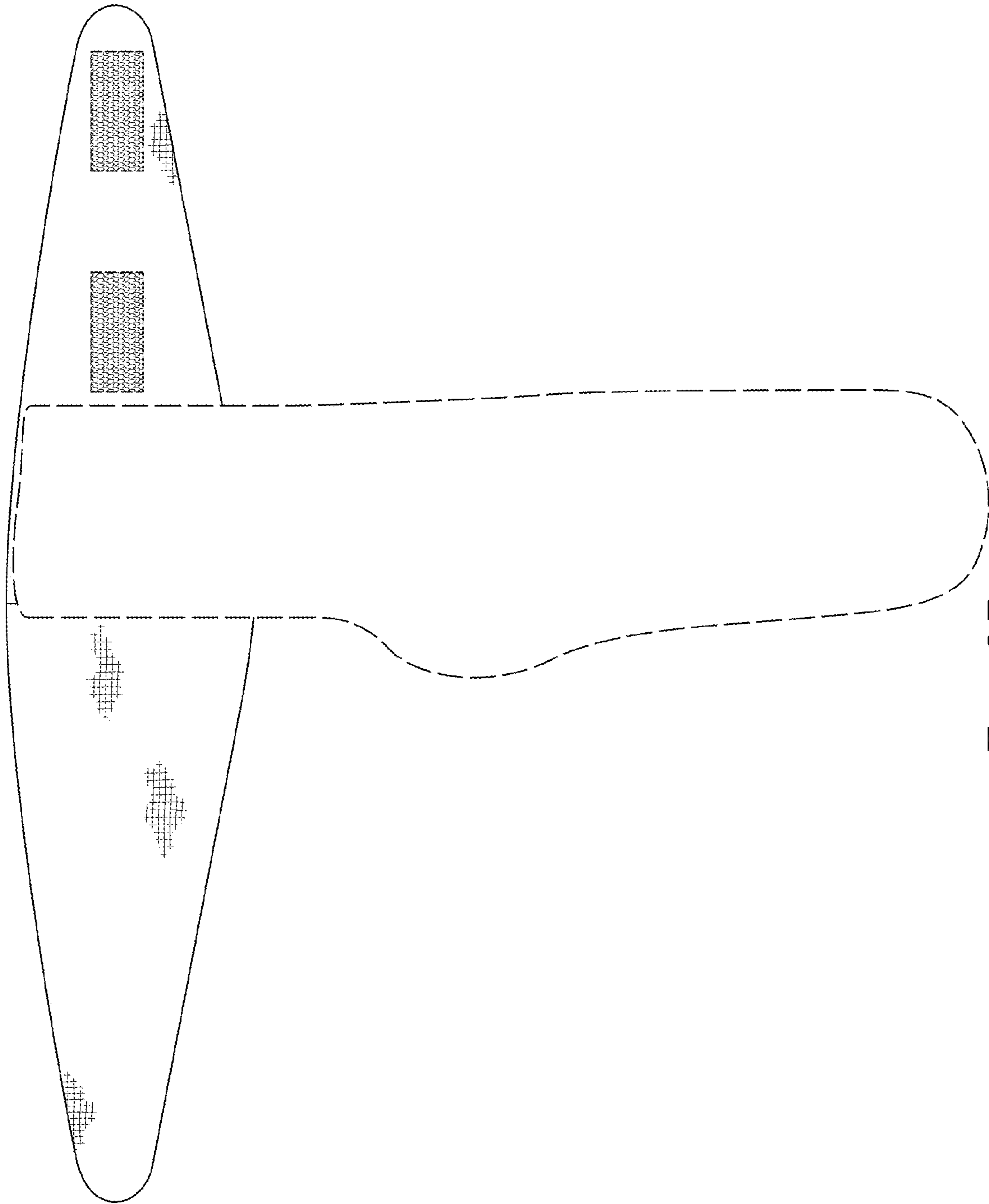

Fig. 37

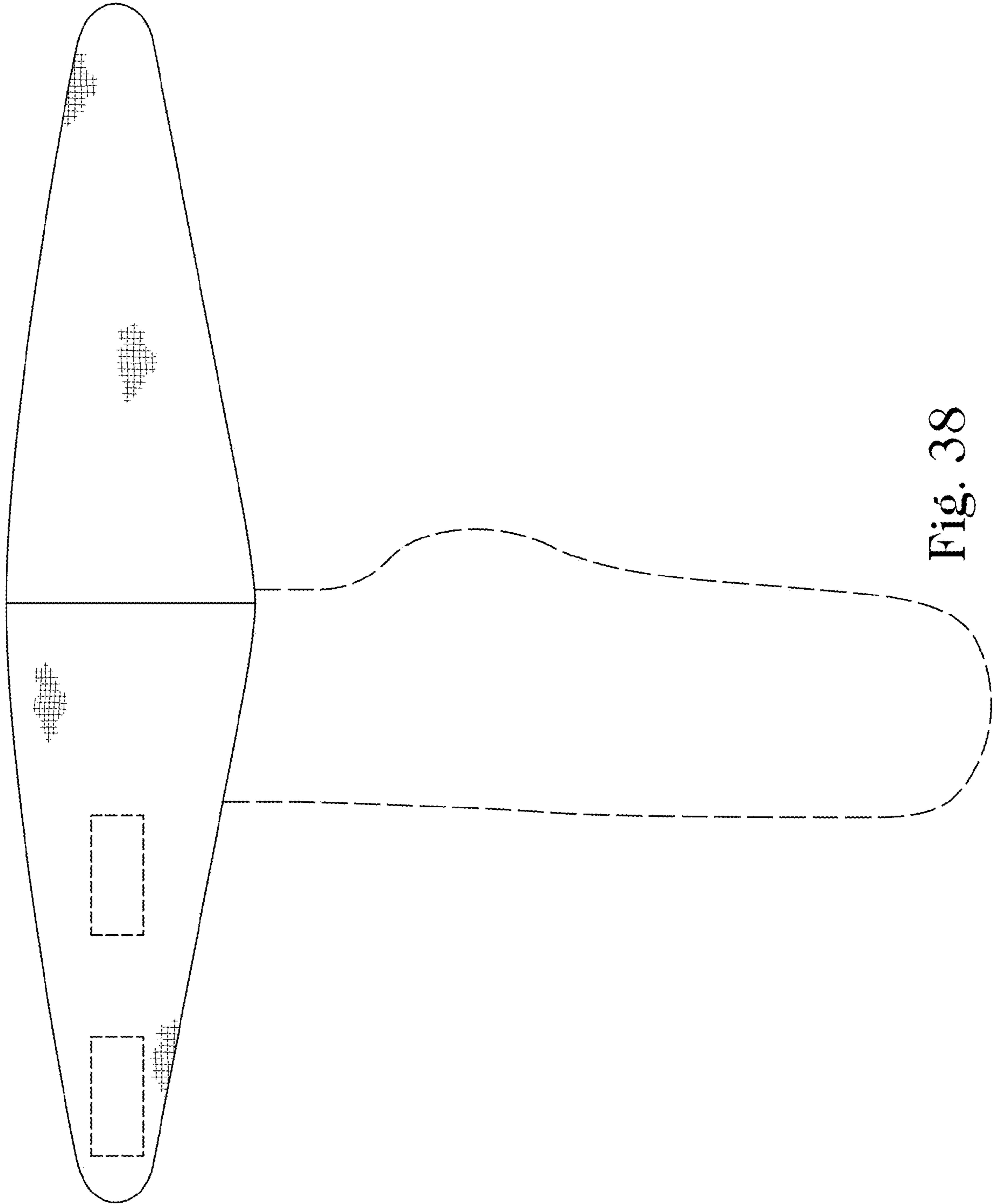

Fig. 38



Fig. 39



Fig. 40

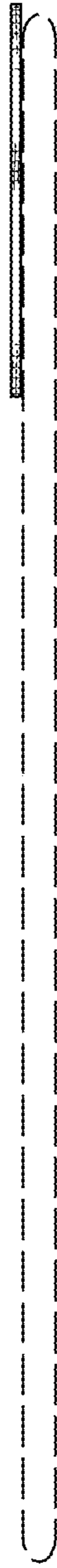

Fig. 41



Fig. 42