



US00D912905S

(12) **United States Design Patent** (10) **Patent No.:** **US D912,905 S**
Nnakwe (45) **Date of Patent:** **** Mar. 9, 2021**

- (54) **WIG STAND**
- (71) Applicant: **Chinelo Nnakwe**, Bronx, NY (US)
- (72) Inventor: **Chinelo Nnakwe**, Bronx, NY (US)
- (**) Term: **15 Years**
- (21) Appl. No.: **29/748,981**
- (22) Filed: **Sep. 2, 2020**
- (51) **LOC (13) Cl.** **28-04**
- (52) **U.S. Cl.**
USPC **D28/93**
- (58) **Field of Classification Search**
USPC D28/93; D20/10; D6/462, 682.1
CPC A45D 44/14; A47F 7/06
See application file for complete search history.

- 3,741,448 A 6/1973 Friedman et al.
- D284,120 S * 6/1986 Chao D28/93
- D538,064 S 3/2007 Schechter
- D649,714 S 11/2011 Key
- D719,769 S * 12/2014 Daniels D6/682.1
- D842,549 S 3/2019 Ndu
- D863,688 S 10/2019 Ndu
- 2019/0166969 A1* 6/2019 Brownlee F26B 25/066
- 2020/0029640 A1* 1/2020 Adams A45D 44/02

* cited by examiner

Primary Examiner — Zenia I Bennett

(74) *Attorney, Agent, or Firm* — Tatonetti IP

(57) **CLAIM**

I claim the ornamental design for a wig stand, as shown and described.

DESCRIPTION

FIG. 1 is a perspective view of the wig stand;
 FIG. 2 is a right side view thereof;
 FIG. 3 is a left side view thereof;
 FIG. 4 is a front side view thereof;
 FIG. 5 is a rear side view thereof;
 FIG. 6 is a top side view thereof;
 FIG. 7 is a bottom side view thereof; and,
 FIG. 8 is a perspective and close-up view of the claimed arm of the wig stand without the environmental features.
 Broken lines, such as those depicted in FIGS. 1-7, are for environmental purposes only and form no part of the claimed design.

1 Claim, 8 Drawing Sheets

(56) **References Cited**

U.S. PATENT DOCUMENTS

- 3,276,734 A * 10/1966 Goldblatt A47F 7/065
248/176.1
- 3,479,106 A * 11/1969 Bohannon A47F 7/065
312/351
- 3,503,581 A * 3/1970 Rouleau A45D 44/14
248/121
- 3,515,318 A * 6/1970 Preble A45D 44/14
223/66
- 3,602,372 A * 8/1971 Verrecchio A47F 7/065
211/100
- 3,615,046 A * 10/1971 Bashara A45D 44/14
223/66

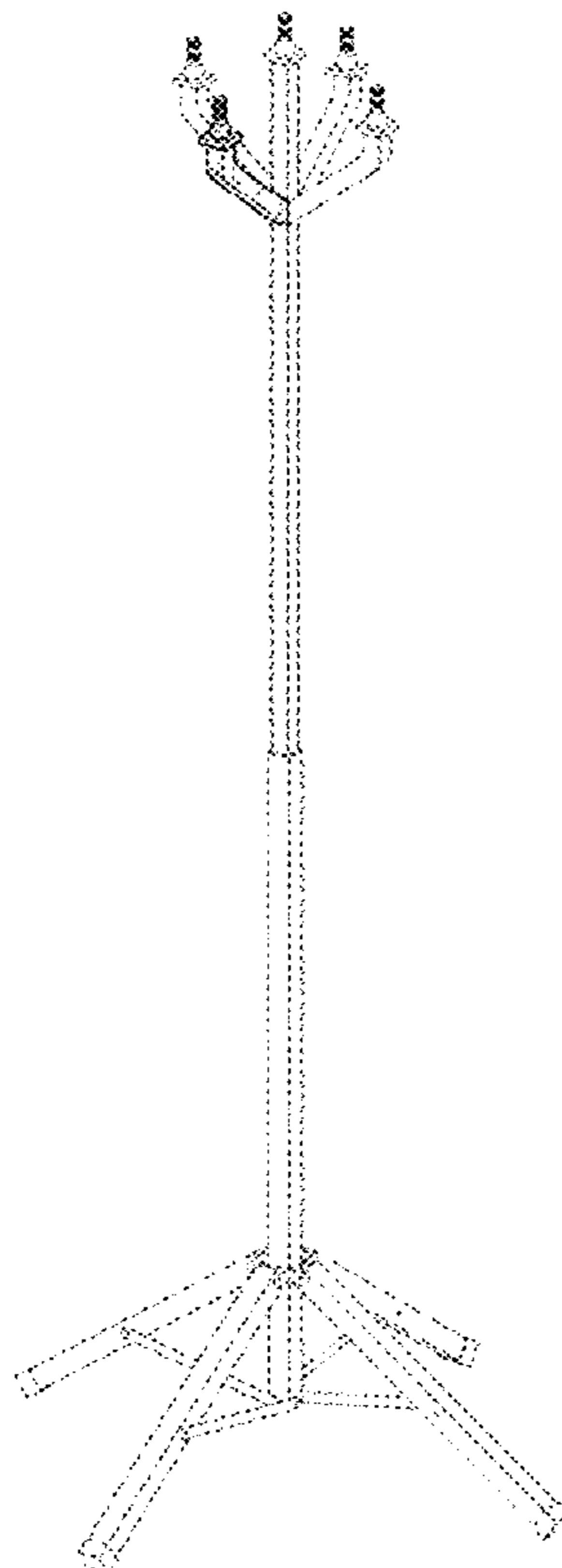

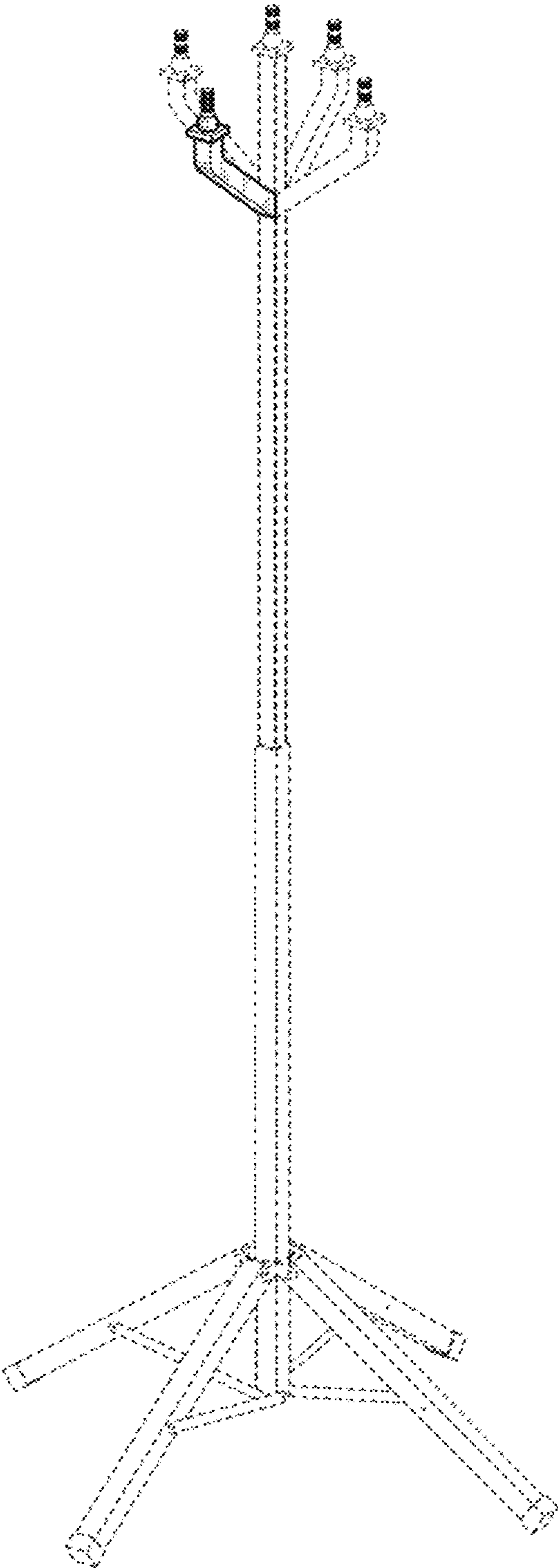

Fig. 1

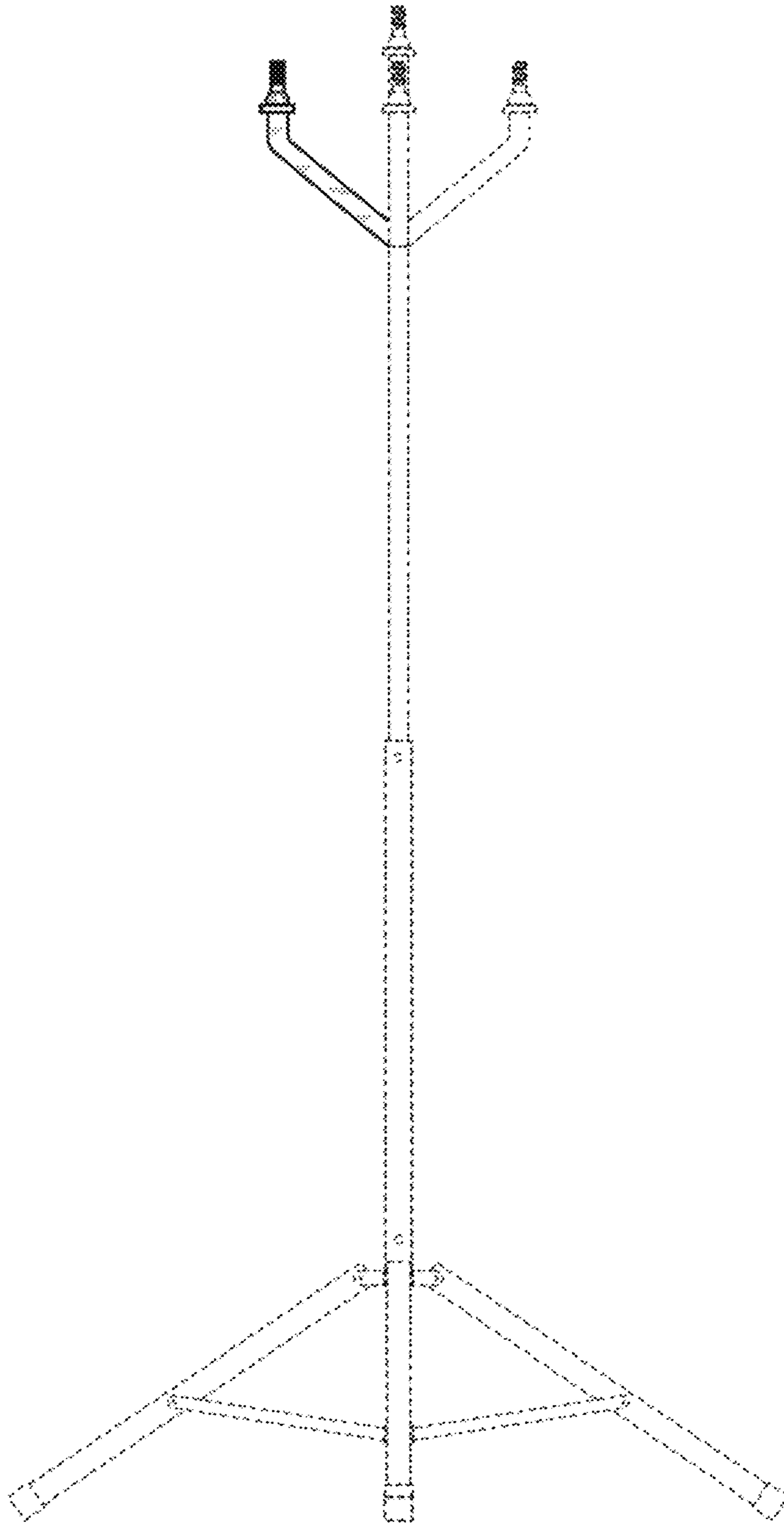

Fig. 2

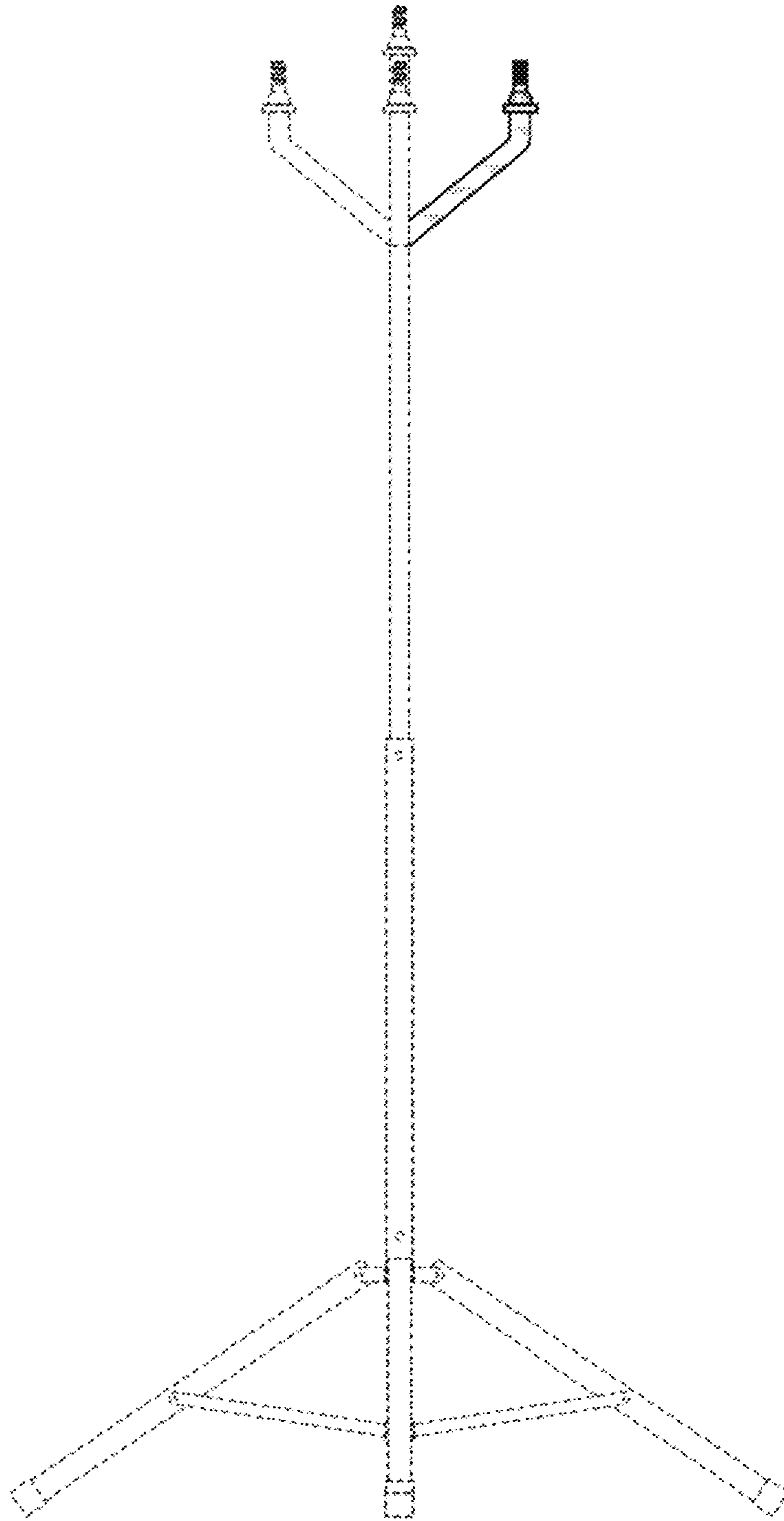

Fig. 3

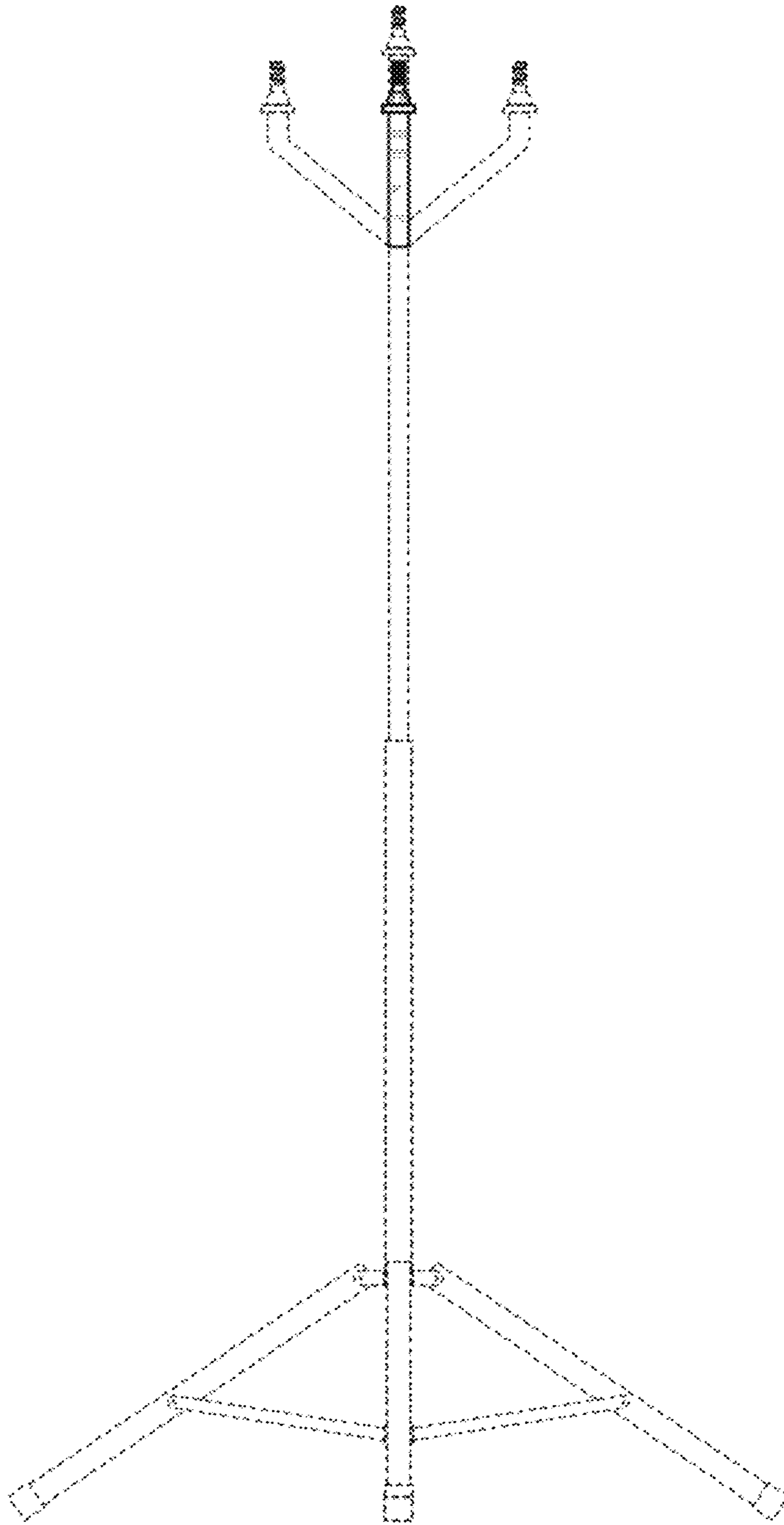

Fig. 4

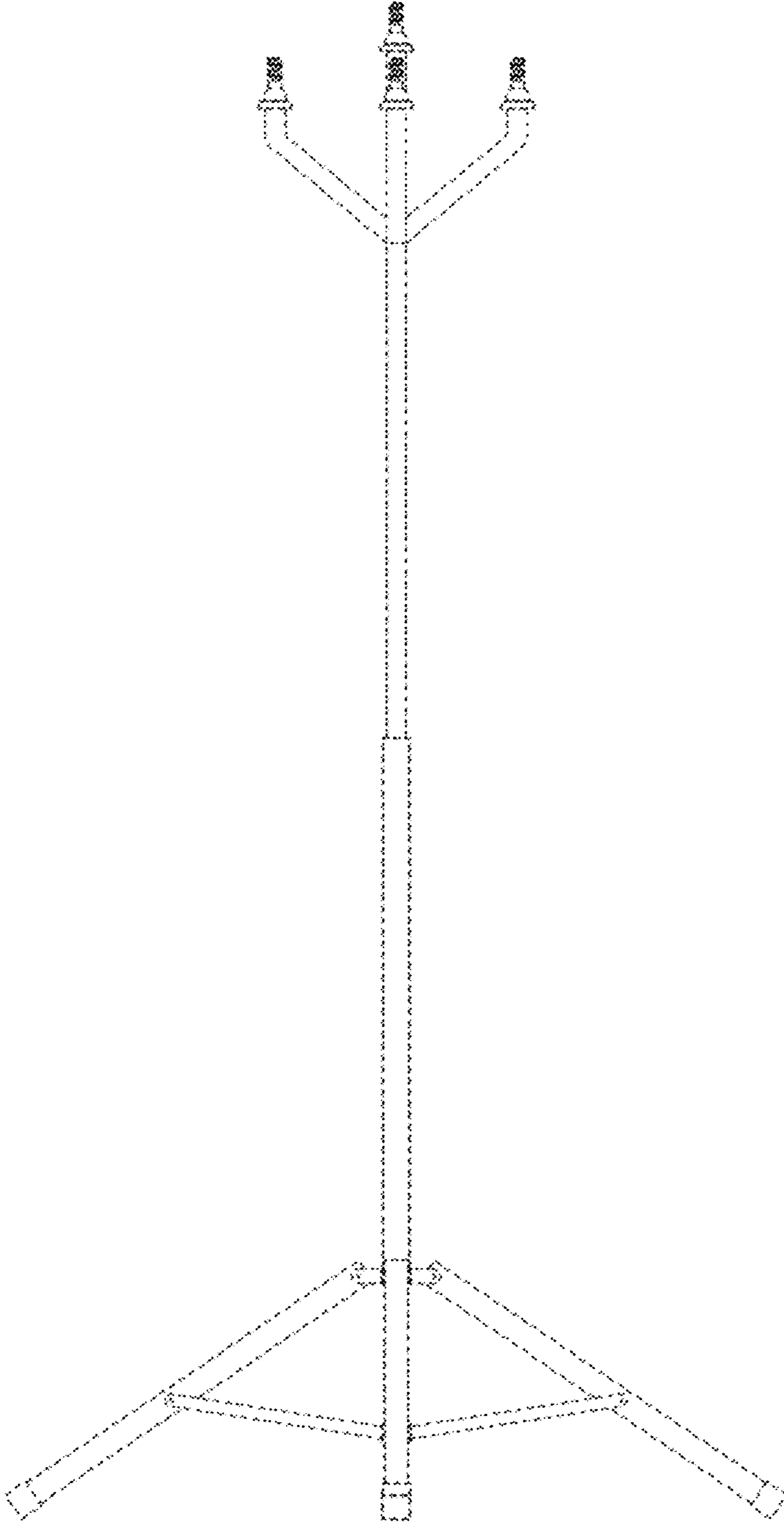

Fig. 5

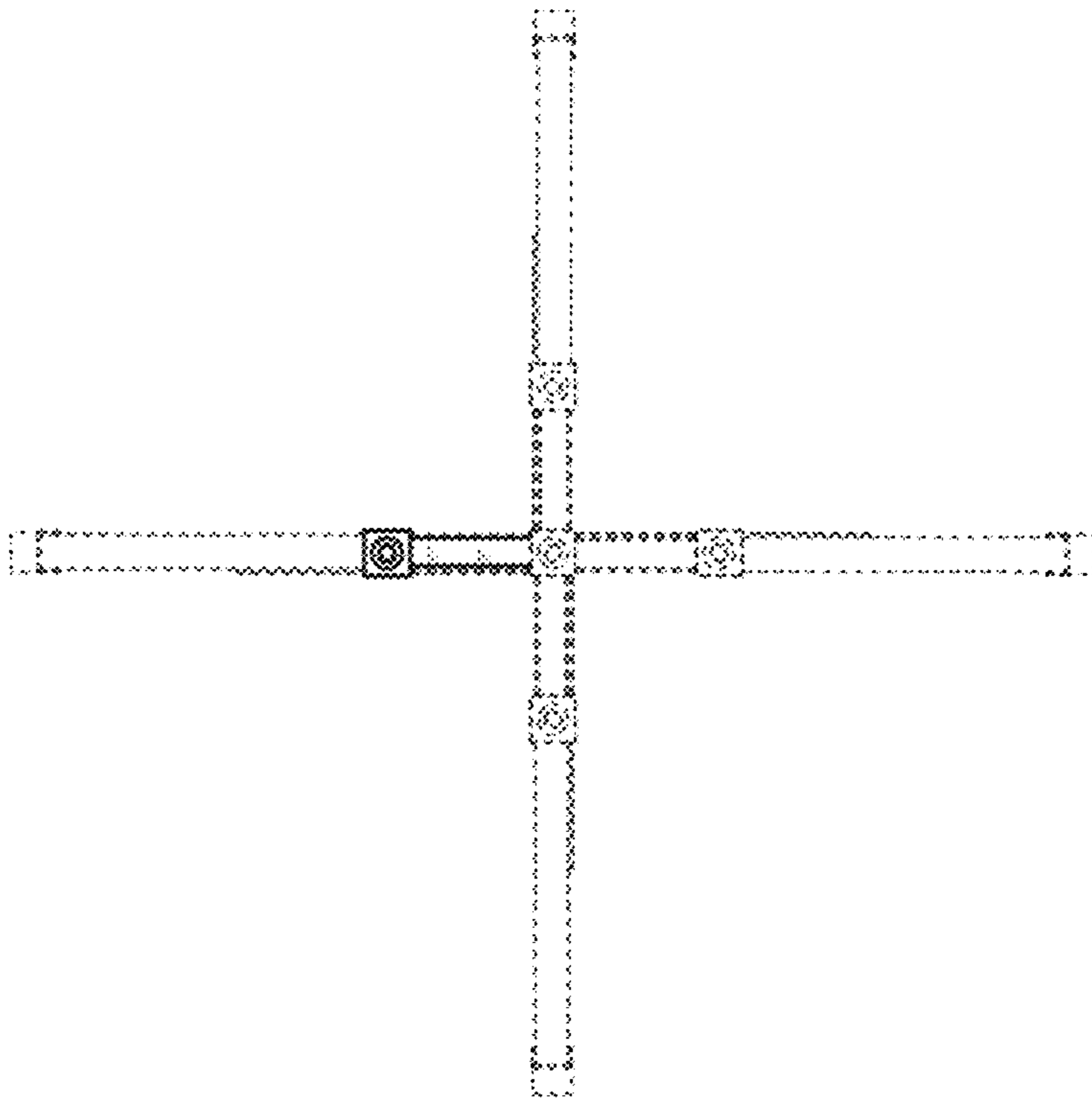

Fig. 6

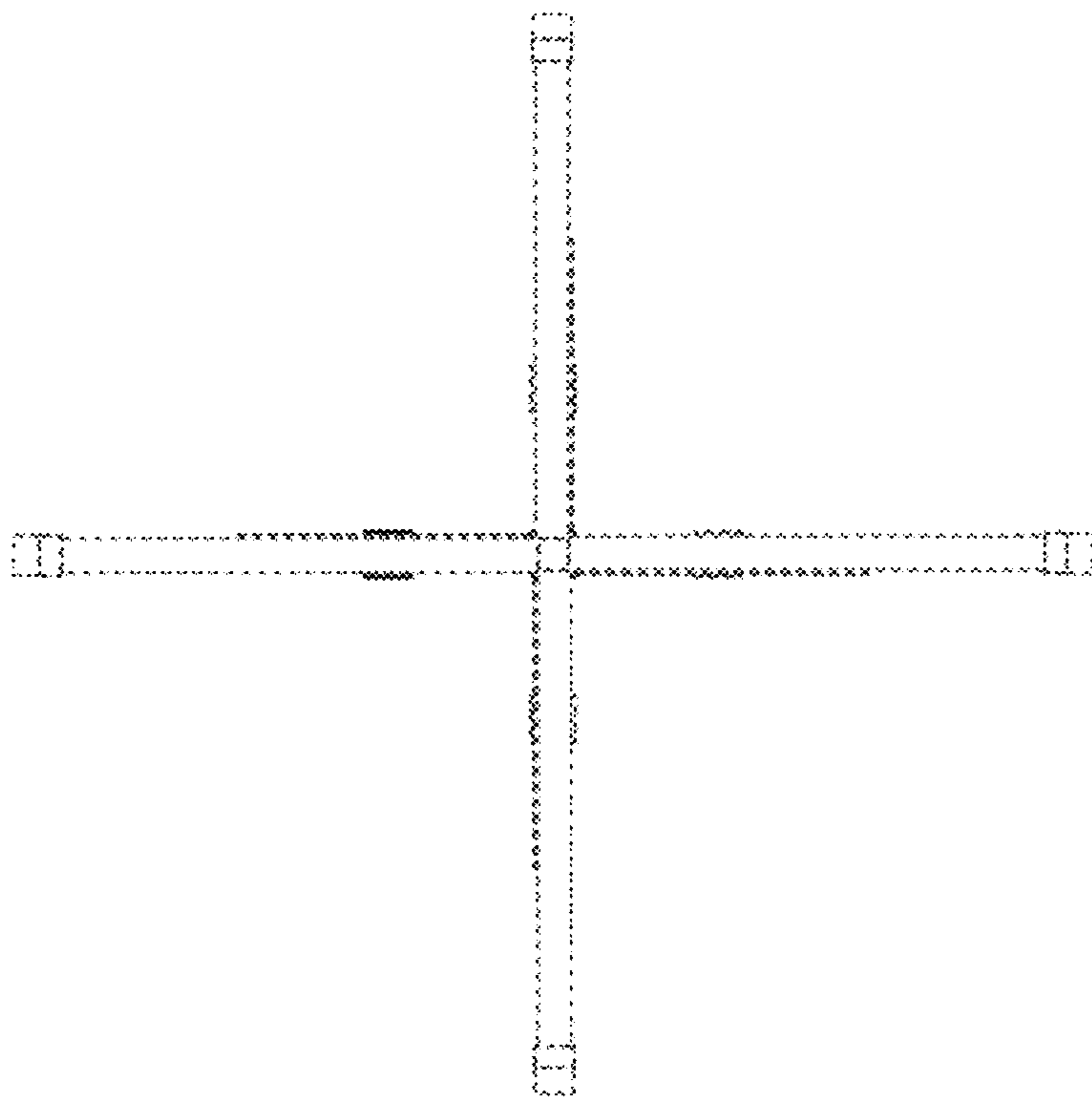

Fig. 7

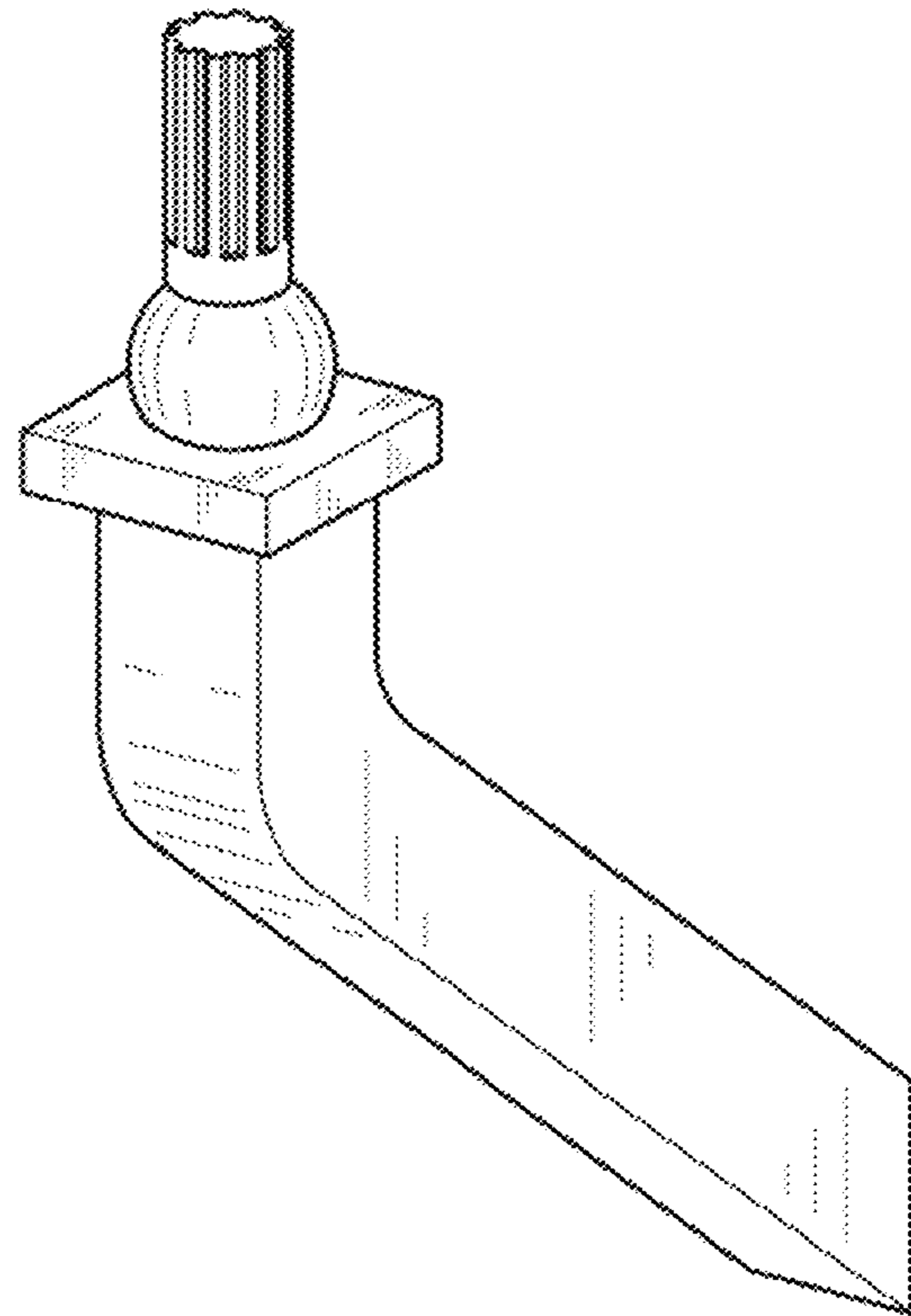

Fig. 8