



US00D912806S

(12) **United States Design Patent** (10) **Patent No.:** **US D912,806 S**
Lei et al. (45) **Date of Patent:** **** Mar. 9, 2021**

- (54) **URINE CUP** 5,119,830 A * 6/1992 Davis B01L 3/502
422/568
- (71) Applicants: **Healgen Scientific Limited**, Houston, TX (US); **Zhejiang Orient Gene Biotech Co., LTD**, Zhejiang (CN) D328,492 S * 8/1992 Mathis D10/46.2
D390,668 S * 2/1998 Lewandowski D24/224
6,572,827 B2 * 6/2003 Wilkinson B01L 3/502
141/1
- (72) Inventors: **Siyu Lei**, Zhejiang (CN); **Jianqiu Fang**, Houston, TX (US) D610,254 S * 2/2010 Huff D24/121
D610,700 S * 2/2010 Khoury D24/121
D647,211 S * 10/2011 Belfance D24/224
D695,416 S * 12/2013 Saliaris D24/224
- (73) Assignees: **Healgen Scientific Limited**, Houston, TX (US); **Zhejiang Orient Gene Biotech Co., Ltd.**, Zhejiang (CN) D717,469 S * 11/2014 Nemeth D24/224
D775,327 S * 12/2016 Fuller D24/122
D775,726 S * 1/2017 Giancursio, II D24/121

* cited by examiner

(**) Term: **15 Years**

(21) Appl. No.: **29/662,093**

(22) Filed: **Aug. 31, 2018**

Related U.S. Application Data

(63) Continuation of application No. 15/475,891, filed on Mar. 31, 2017.

(30) **Foreign Application Priority Data**

Oct. 19, 2016 (CN) 201621134130.5

(51) **LOC (13) Cl.** **24-02**

(52) **U.S. Cl.**
USPC **D24/122**

(58) **Field of Classification Search**
USPC D24/121-123, 224; 4/144.1-144.4, 459, 4/460; 604/329, 317, 318, 334; 600/573, 600/574

CPC A61G 9/00; A61G 9/006
See application file for complete search history.

(56) **References Cited**

U.S. PATENT DOCUMENTS

- 3,881,465 A * 5/1975 Raitto A61B 10/007
600/573
- D258,311 S * 2/1981 Peterson D24/121

Primary Examiner — David G Muller

(74) *Attorney, Agent, or Firm* — Thomas Horstemeyer, LLP

(57) **CLAIM**

The ornamental design for a urine cup, as shown and described.

DESCRIPTION

FIG. 1 is a front view of an embodiment of the urine cup according to the present design;
FIG. 2 is a back view of the urine cup of FIG. 1;
FIG. 3 is a top view of the urine cup of FIG. 1;
FIG. 4 is a bottom view of the urine cup of FIG. 1;
FIG. 5 is a right view of the urine cup of FIG. 1;
FIG. 6 is a left view of the urine cup of FIG. 1;
FIG. 7 is a perspective view of the urine cup of FIG. 1; and, FIG. 8 is another perspective view of the urine cup of FIG. 1.

The broken line showing of parts of the drawings is included for the purpose of illustrating use and environment and forms no part of the claimed design.

1 Claim, 8 Drawing Sheets

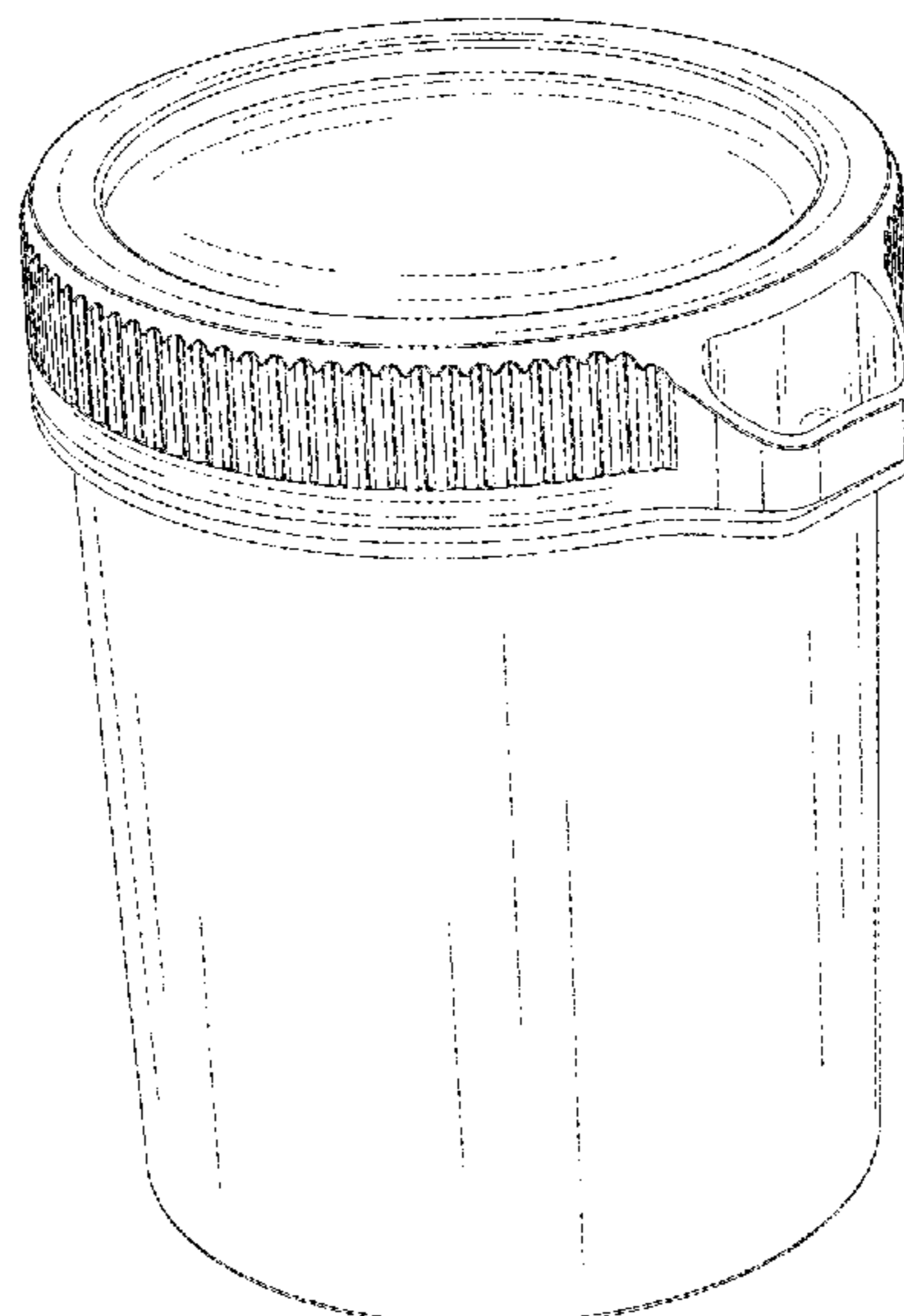

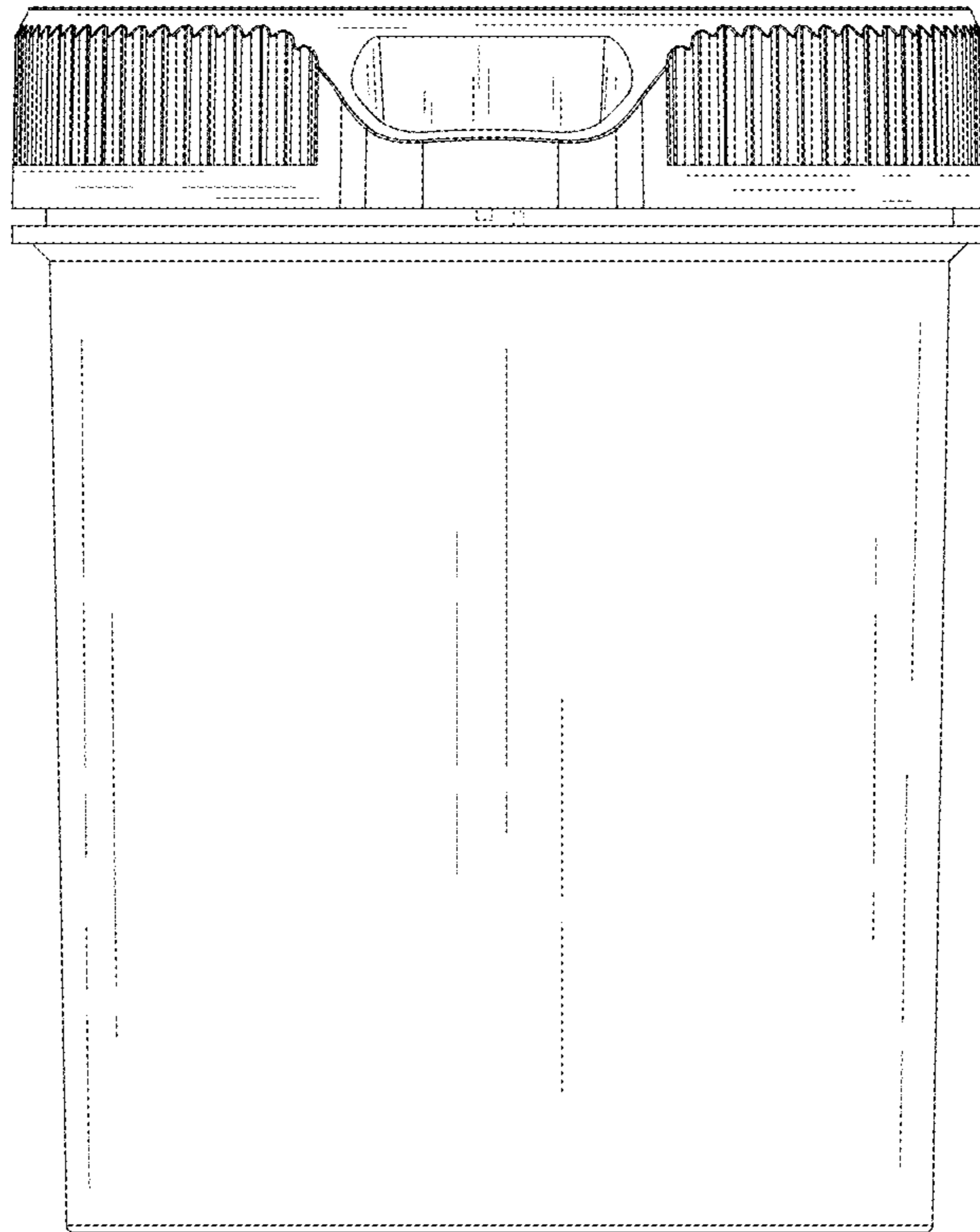

FIG. 1

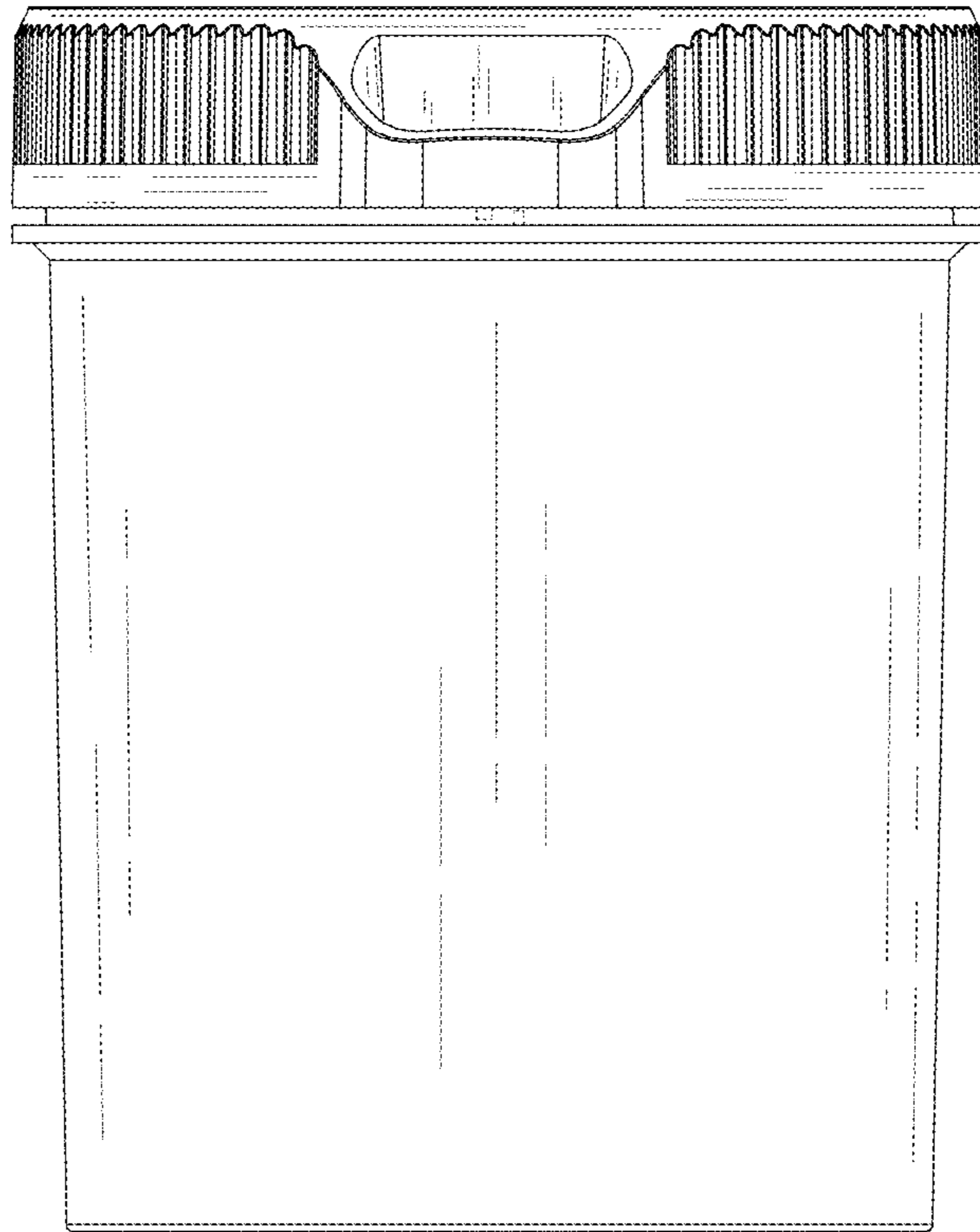

FIG. 2

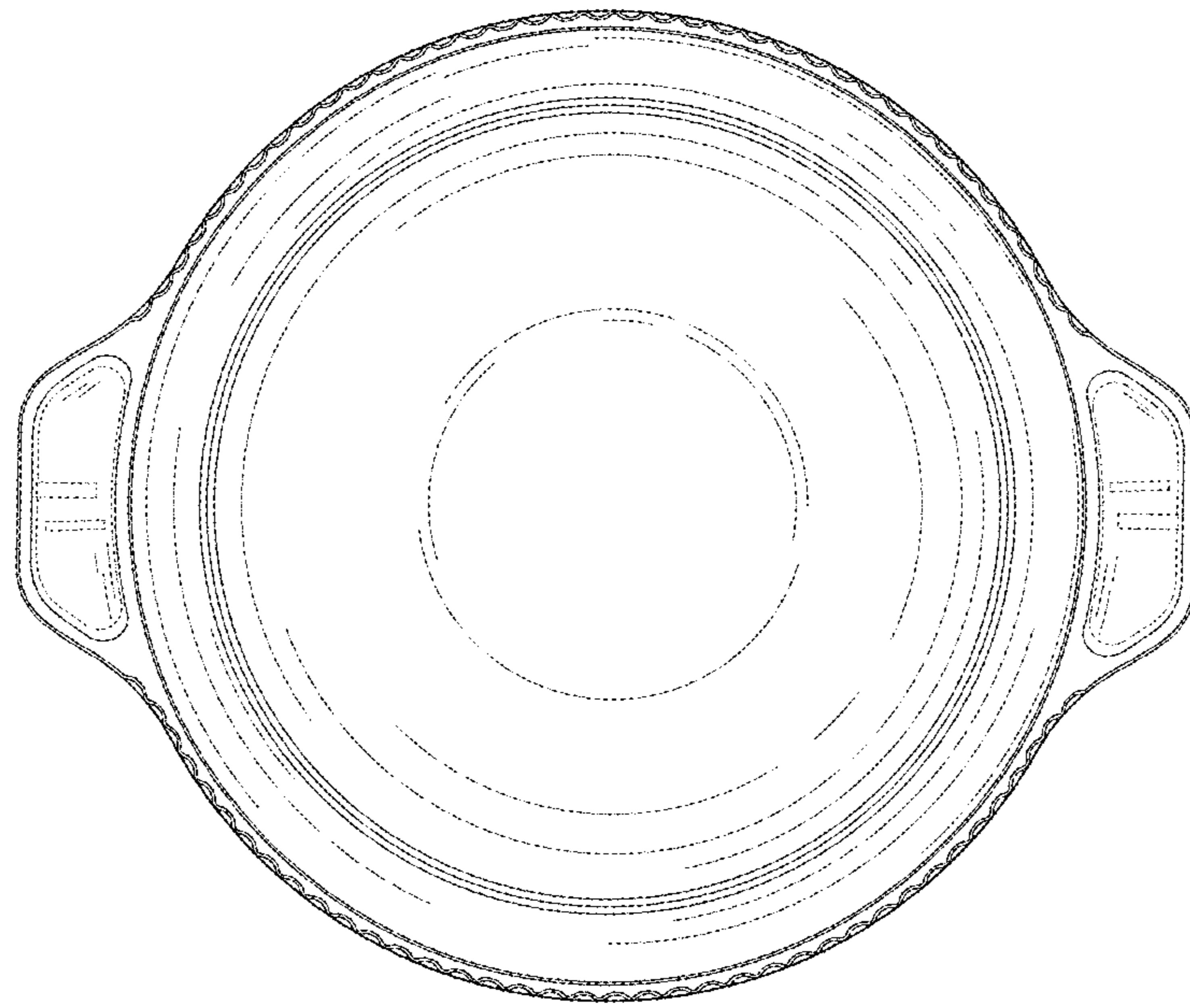

FIG. 3

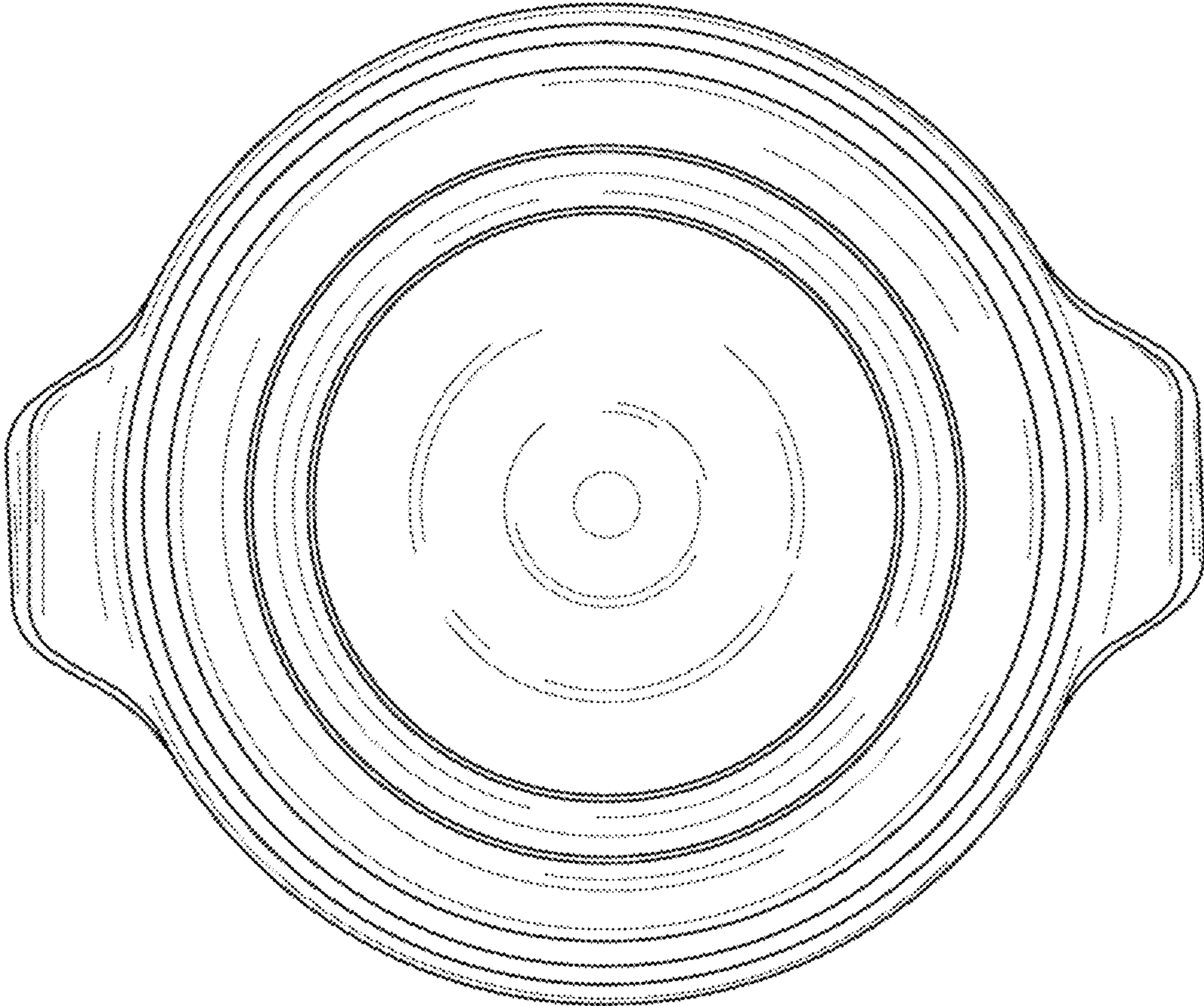

FIG. 4

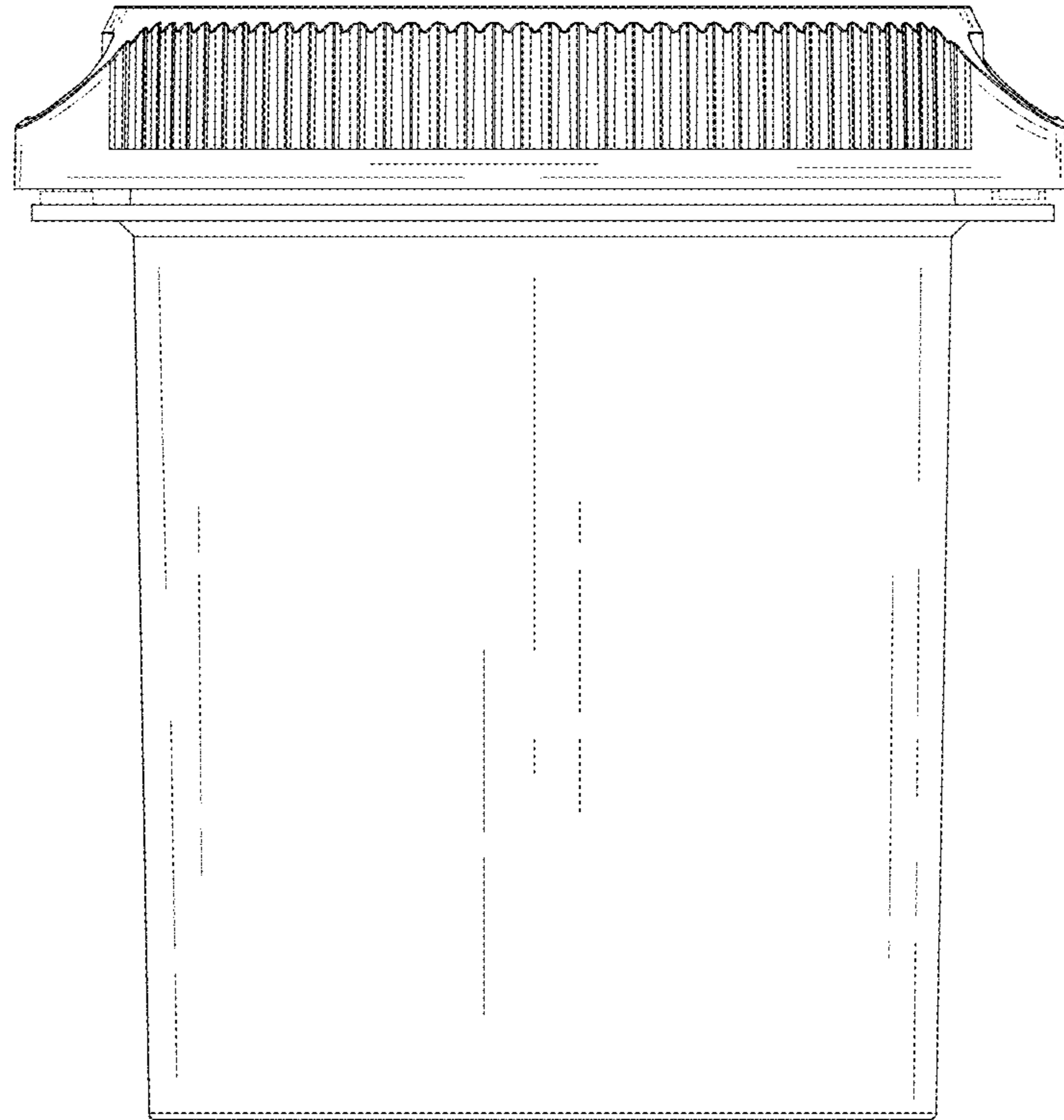

FIG. 5

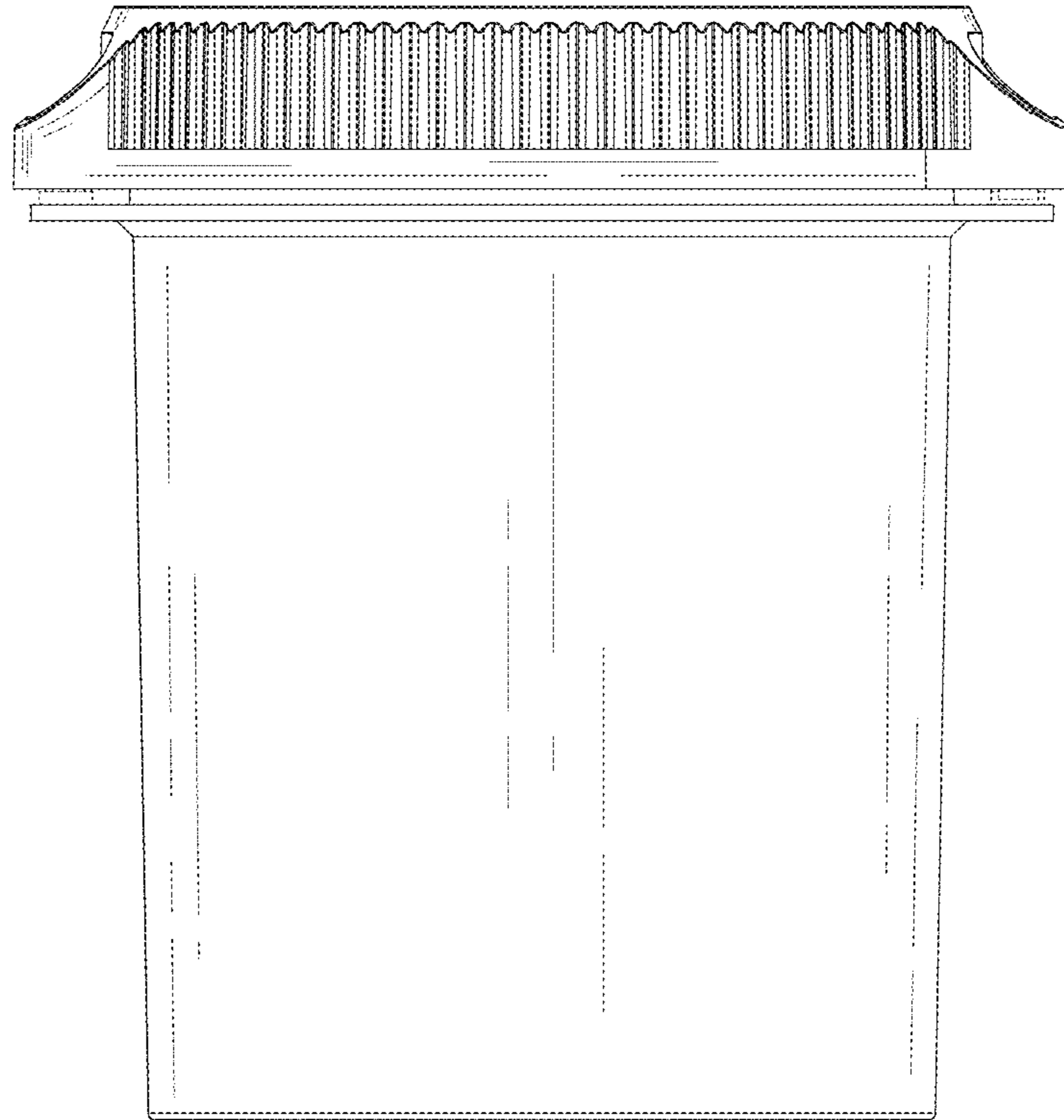

FIG. 6

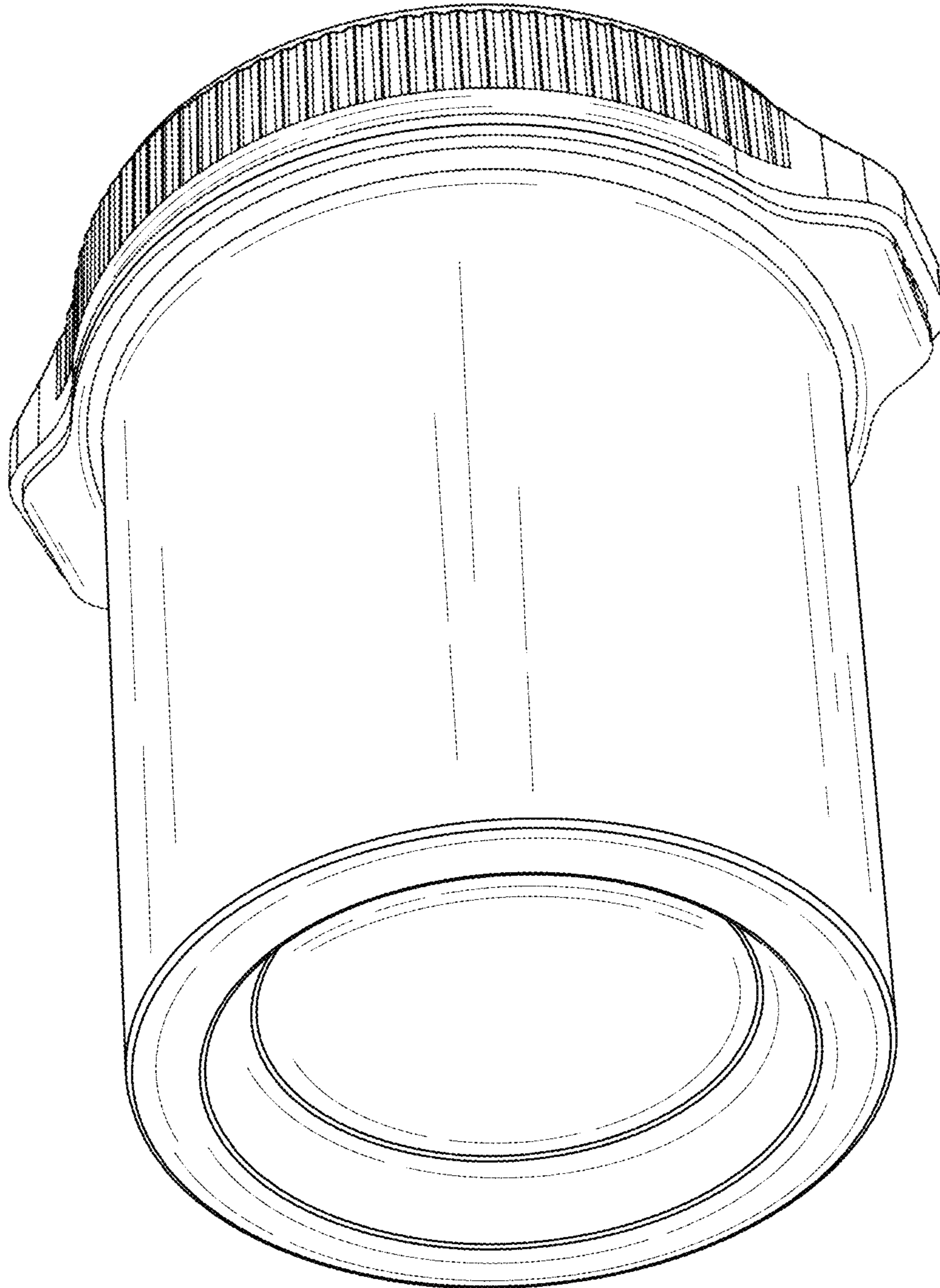

FIG. 7

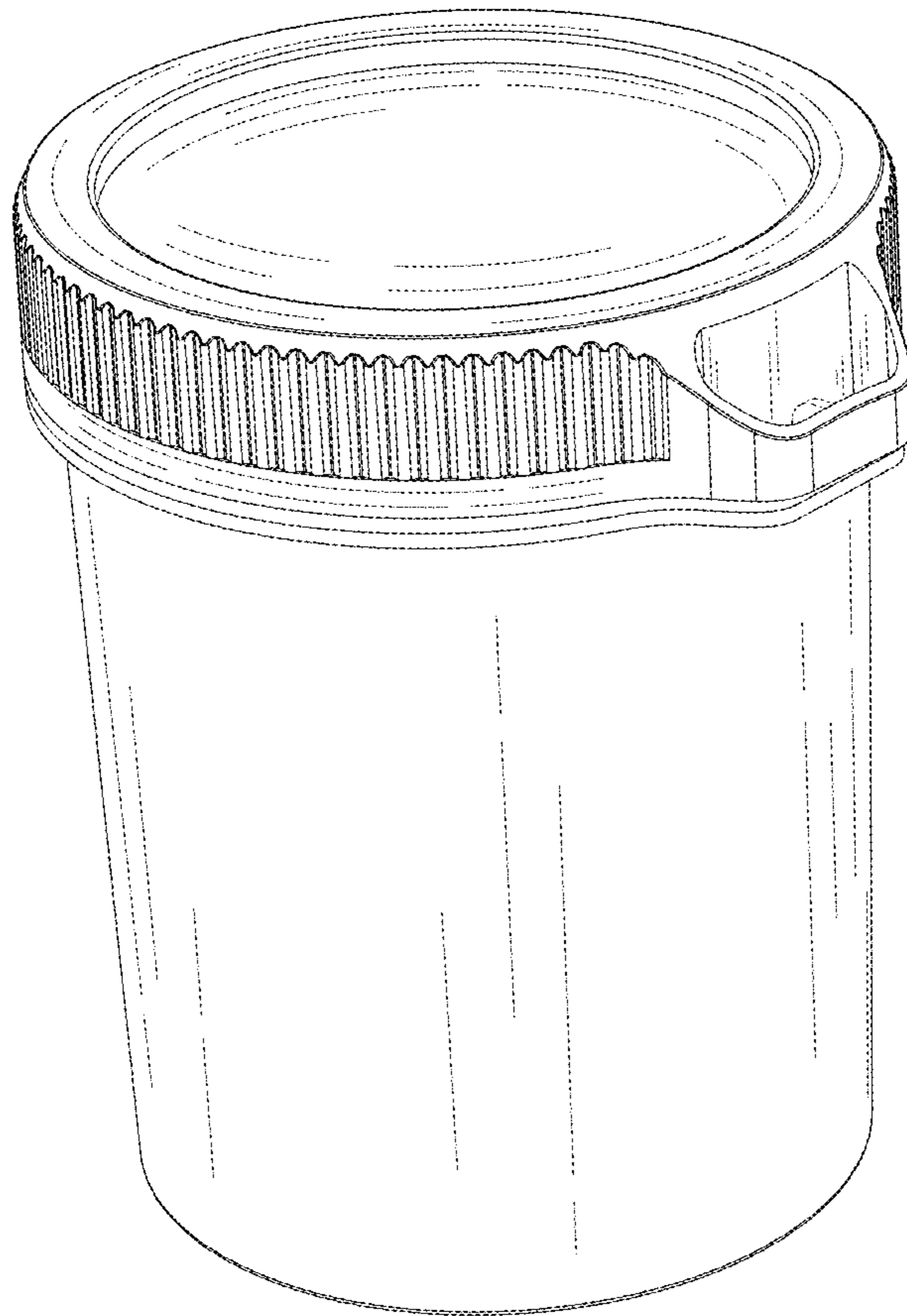

FIG. 8