



US00D912805S

(12) **United States Design Patent**
Lee-Sepsick et al.

(10) **Patent No.:** **US D912,805 S**
(45) **Date of Patent:** **** Mar. 9, 2021**

(54) **DEVICE FOR DELIVERY OF MEDICAL SOLUTIONS**

(71) Applicant: **Femasys, Inc.**, Suwanee, GA (US)

(72) Inventors: **Kathy Lee-Sepsick**, Suwanee, GA (US); **Jeremy A. Sipos**, Alpharetta, GA (US)

(73) Assignee: **FEMASYS INC**, Suwanee, GA (US)

(**) Term: **15 Years**

(21) Appl. No.: **29/703,724**

(22) Filed: **Aug. 29, 2019**

(51) **LOC (13) Cl.** **24-02**

(52) **U.S. Cl.**
USPC **D24/114**

(58) **Field of Classification Search**
USPC D24/112–114, 108, 133, 130, 127, 186;
606/181, 185; 604/264, 272, 187, 181,
604/184, 227

(Continued)

(56) **References Cited**

U.S. PATENT DOCUMENTS

D587,810 S * 3/2009 Weber D24/186
D597,667 S * 8/2009 Racz D24/112
(Continued)

Primary Examiner — David G Muller

(74) *Attorney, Agent, or Firm* — Mary Anthony Merchant

(57) **CLAIM**

The ornamental design for a device for delivery of medical solutions, as shown and described.

DESCRIPTION

FIG. 1 is a perspective view of an embodiment of a device for delivery of medical solutions of the present disclosure;

FIG. 2 is a perspective view of the device of FIG. 1; FIG. 3 is a front end elevational view of the device of FIG. 1; FIG. 4 is a back end elevational view of the device of FIG. 1; FIG. 5 is a right side elevational view of the device of FIG. 1; FIG. 6 is a left elevational view of the device of FIG. 1; FIG. 7 is a top elevational view of the device of FIG. 1; FIG. 8 is a bottom elevational view of the device of FIG. 1; FIG. 9 is a rightward perspective view of the device of FIG. 1; FIG. 10 is a perspective view of the device of FIG. 1 with the balloon catheter extended outwardly. FIG. 11 is a perspective view of the device of FIG. 10; FIG. 12 is a front end elevational view of the device of FIG. 10; FIG. 13 is a back end elevational view of the device of FIG. 10; FIG. 14 is a right side elevational view of the device of FIG. 10; FIG. 15 is a left elevational view of the device of FIG. 10; FIG. 16 is a top elevational view of the device of FIG. 10; FIG. 17 is a bottom elevational view of the device of FIG. 10; FIG. 18 is a perspective view of the device of FIG. 10; FIG. 19 is a perspective view of the device of FIG. 1 with the device plunger moved inward; FIG. 20 a perspective view of the device of FIG. 19; FIG. 21 is a front end elevational view of the device of FIG. 19; FIG. 22 is a back end elevational view of the device of FIG. 19; FIG. 23 is a right side elevational view of the device of FIG. 19; FIG. 24 is a left elevational view of the device of FIG. 19; FIG. 25 is a top elevational view of the device of FIG. 19; FIG. 26 is a bottom elevational view of the device of FIG. 19; and, FIG. 27 is a perspective view of the device of FIG. 19.

1 Claim, 15 Drawing Sheets

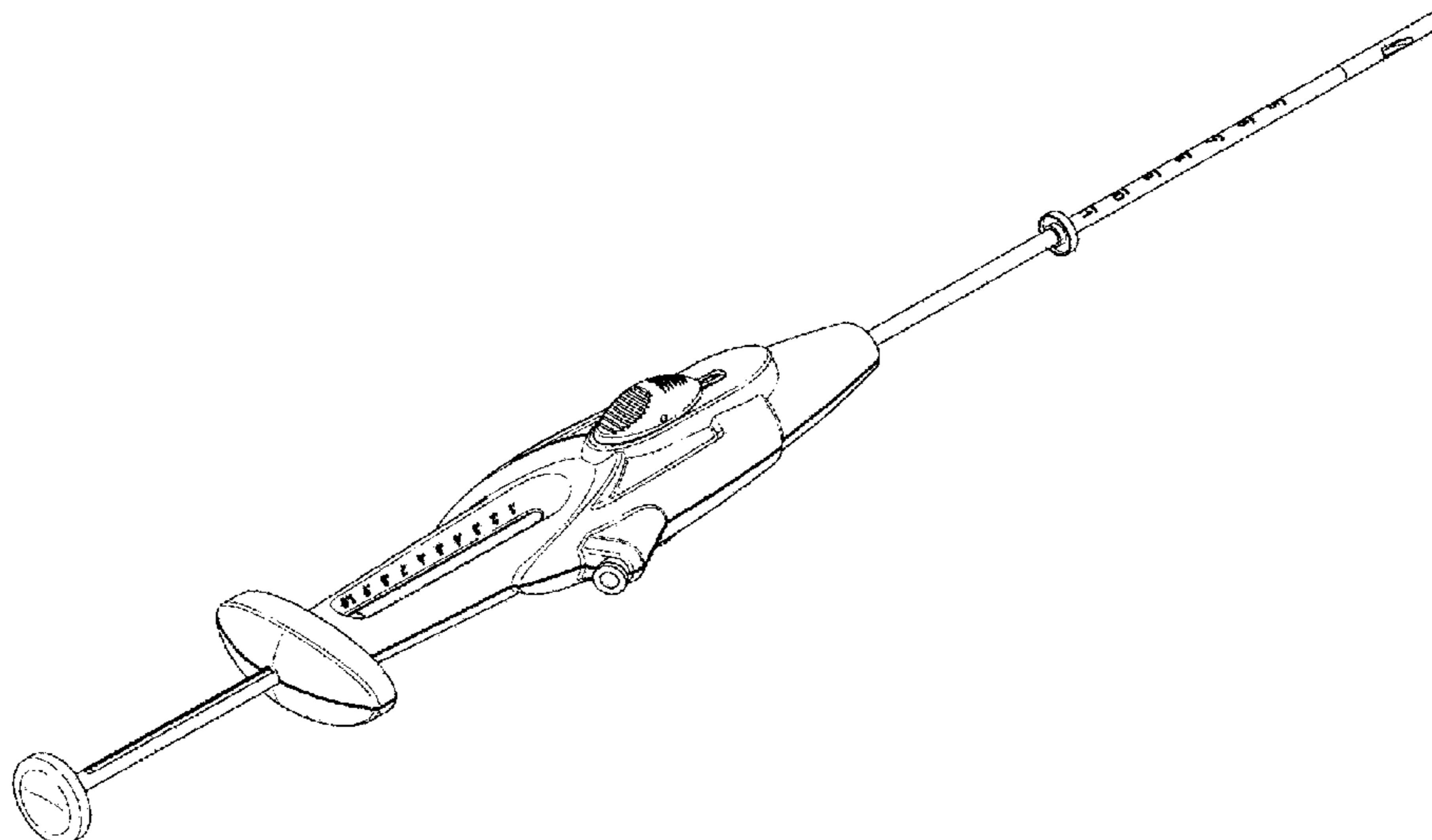

(58) **Field of Classification Search**

CPC A61M 5/178; A61M 3/00; A61M 5/20;
A61M 5/31; A61M 5/3146; A61M
5/3129; A61M 5/3148; A61M 5/315
See application file for complete search history.

(56) **References Cited**

U.S. PATENT DOCUMENTS

D612,044 S * 3/2010 Scheibe D24/130
8,192,369 B2 * 6/2012 Bacon A61B 10/0275
600/567
8,951,276 B2 * 2/2015 Kellerman A61B 17/3468
606/185
D740,410 S * 10/2015 Korkuch D24/112
D771,249 S * 11/2016 Heath D24/133
D834,181 S * 11/2018 Lee-Sepsick D24/112
D856,511 S * 8/2019 Kelly D24/112
D892,309 S * 8/2020 Archat D24/111
D893,018 S * 8/2020 Fuentes-Ortega D24/112
2019/0381252 A1 * 12/2019 Joseph A61M 5/31586
2020/0147349 A1 * 5/2020 Holt A61M 5/3134

* cited by examiner

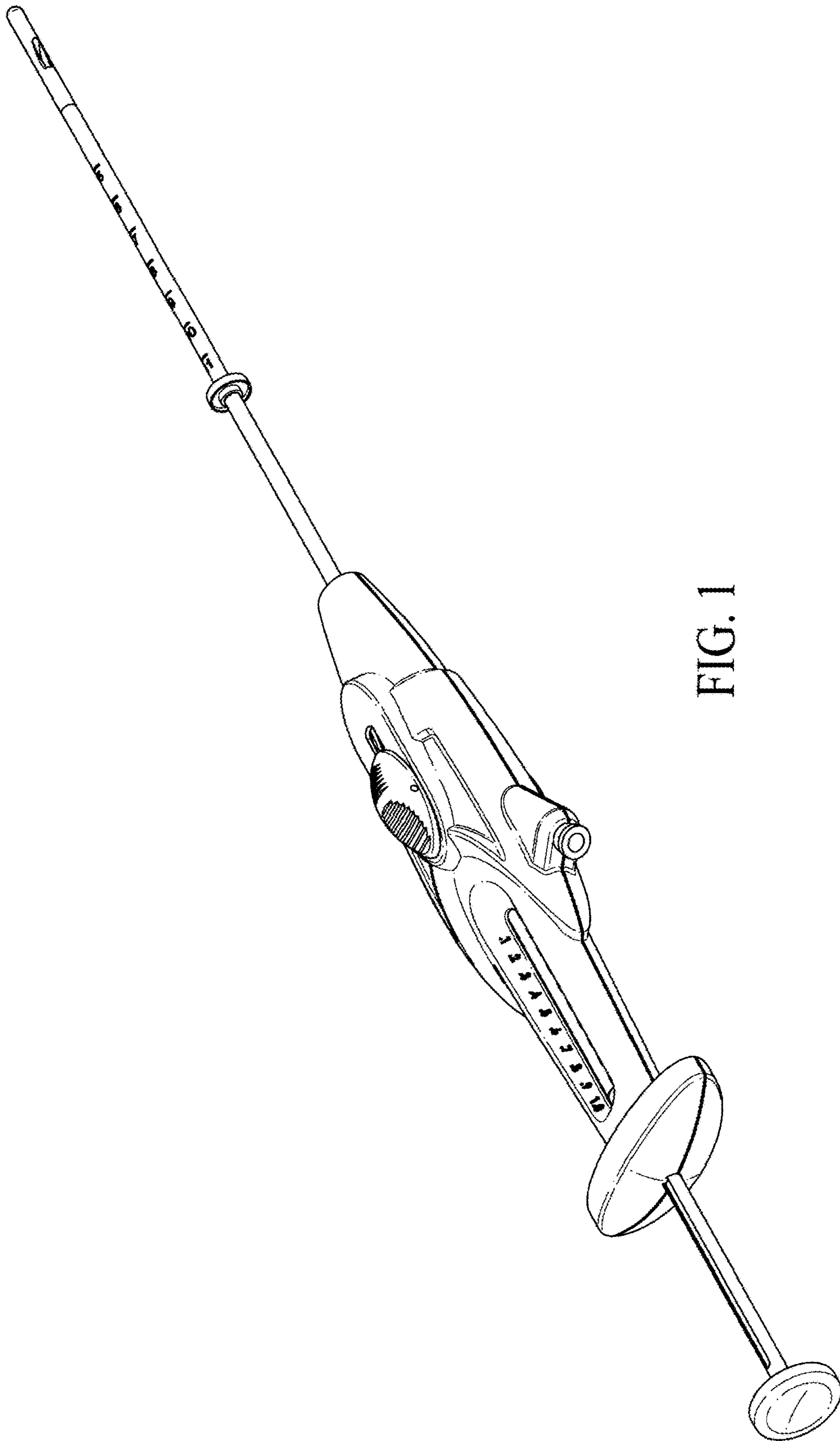

FIG. 1

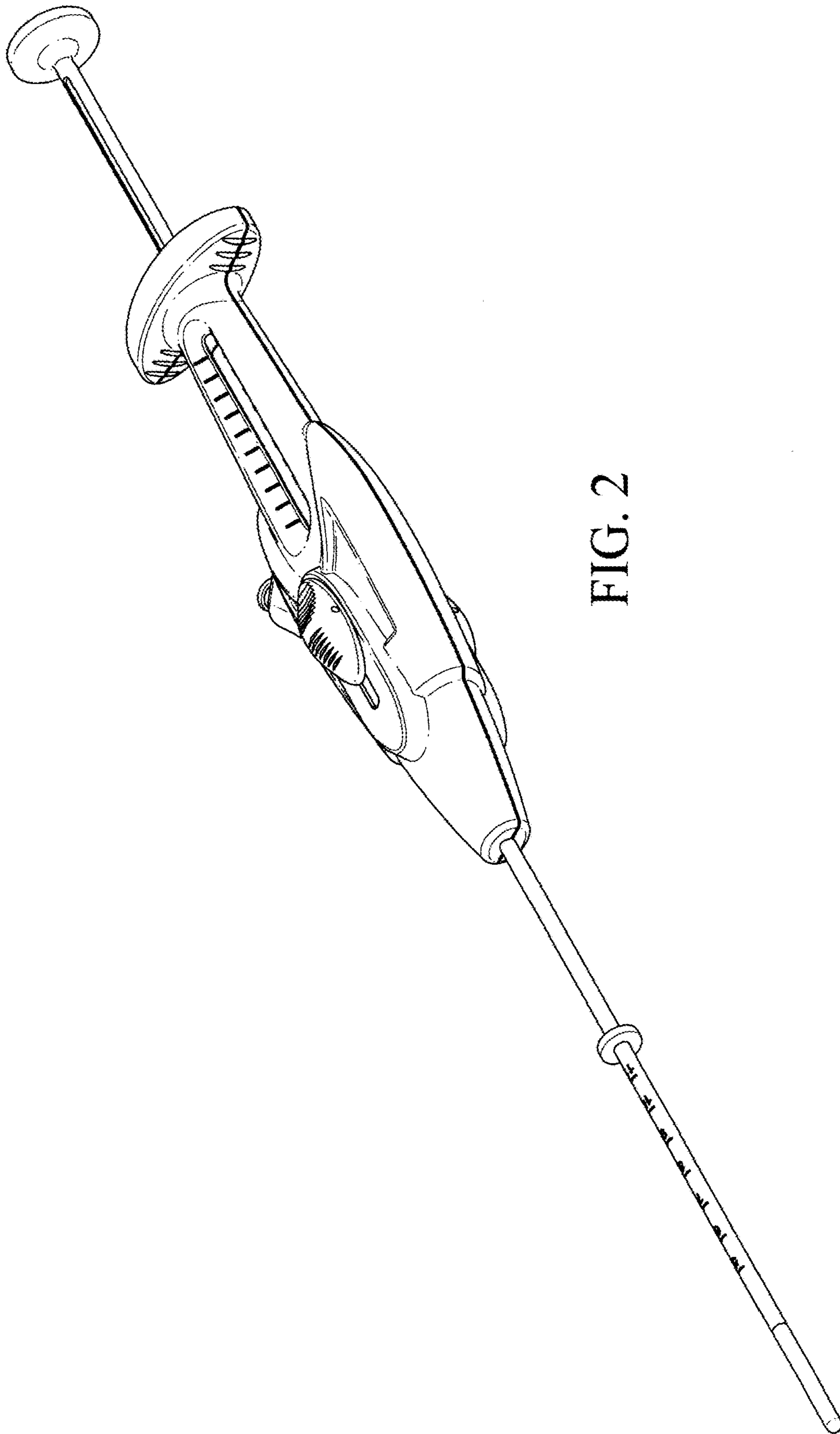

FIG. 2

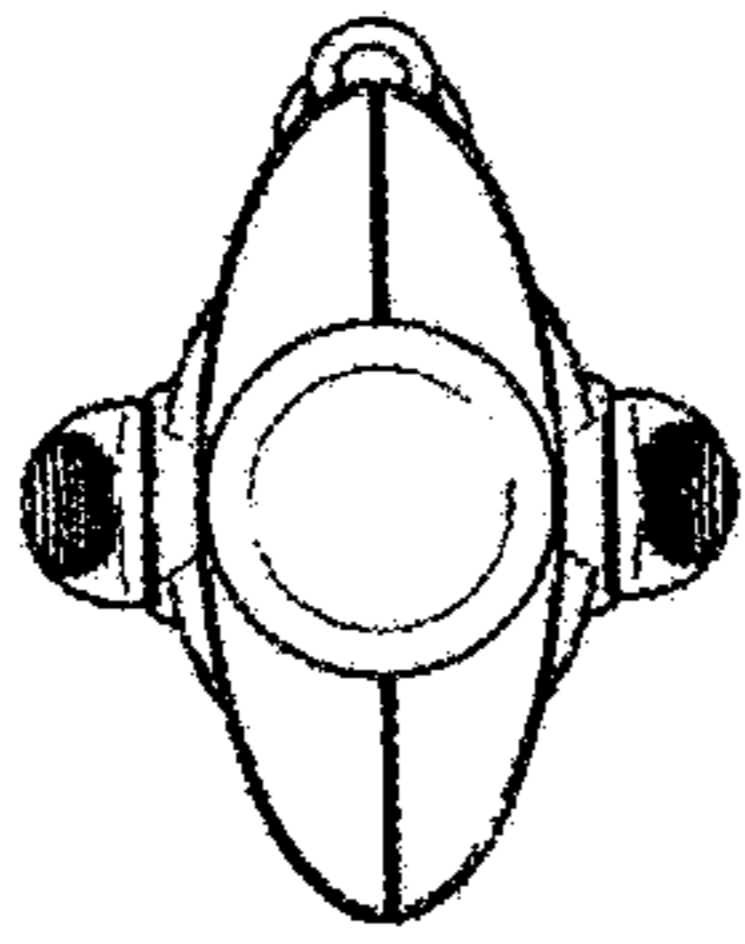

FIG. 3

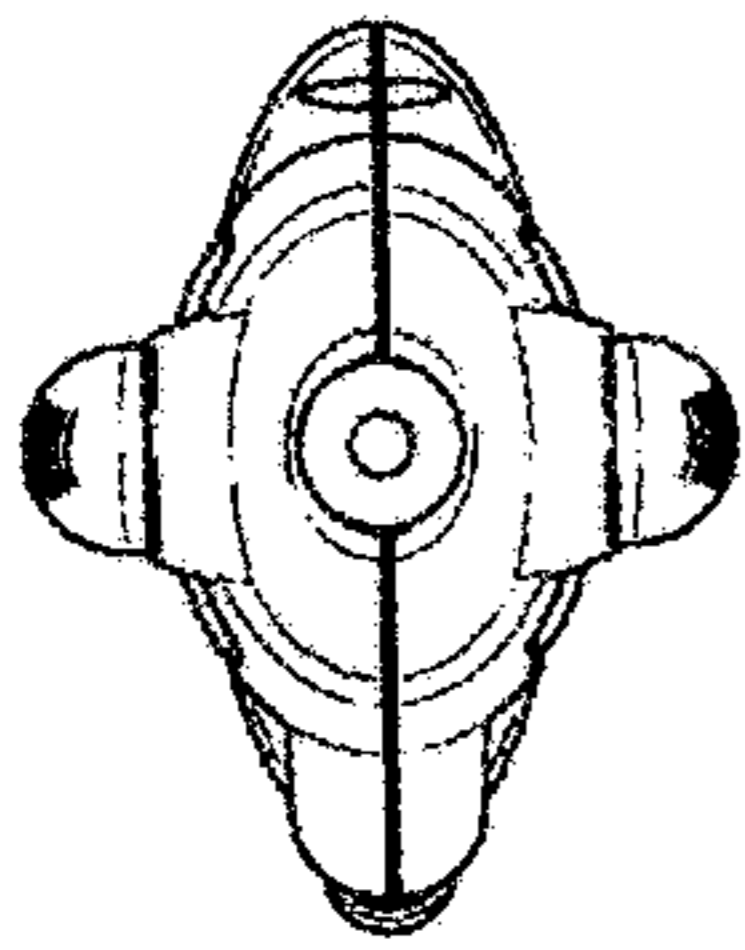

FIG. 4

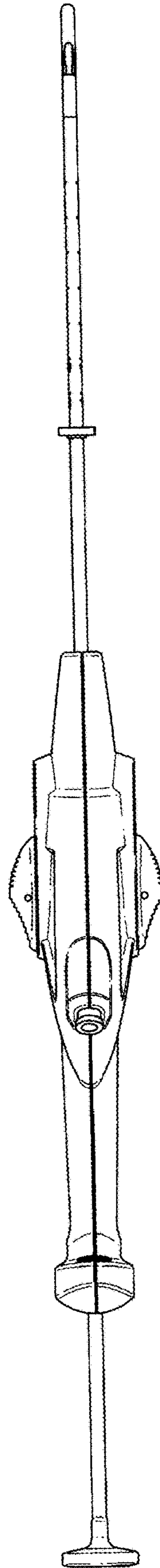

FIG. 5

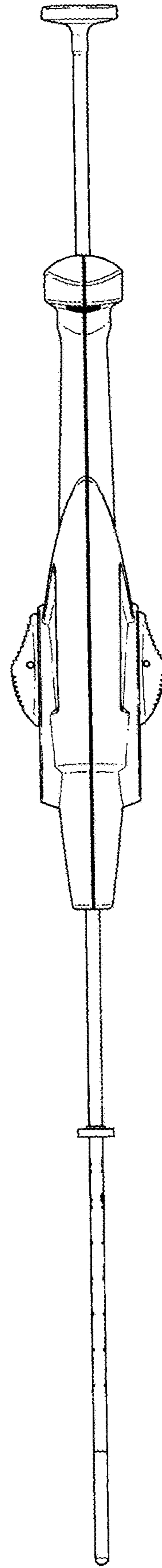

FIG. 6

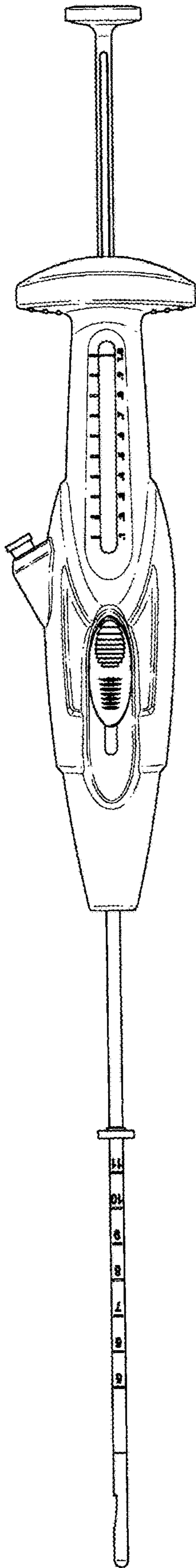

FIG. 7

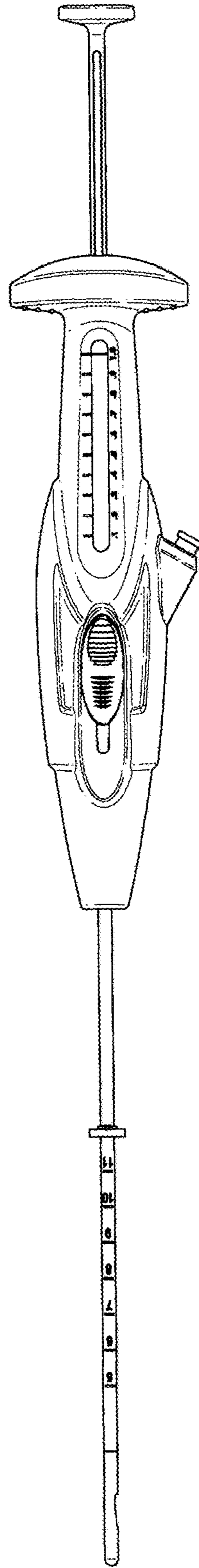

FIG. 8

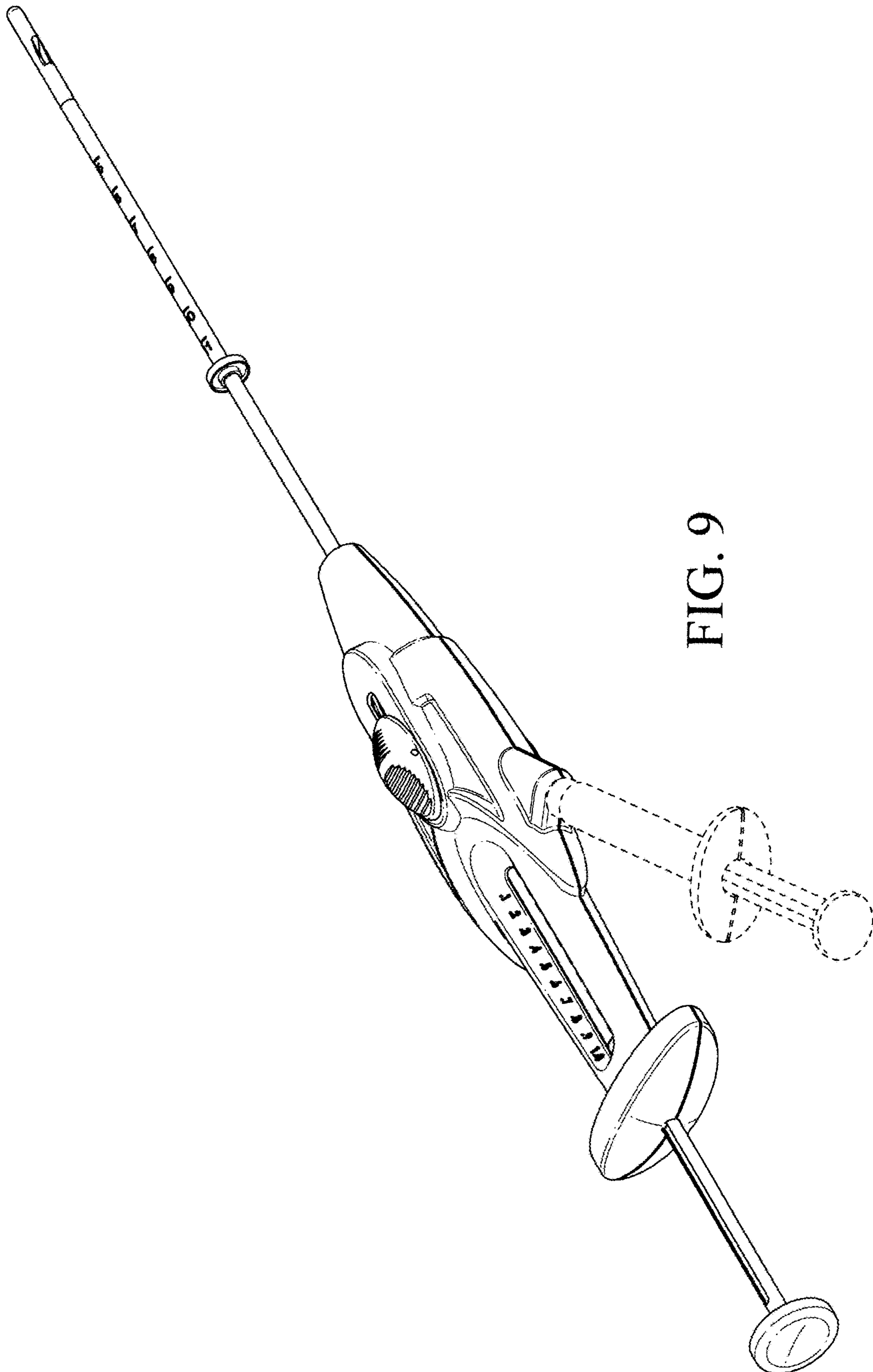

FIG. 9

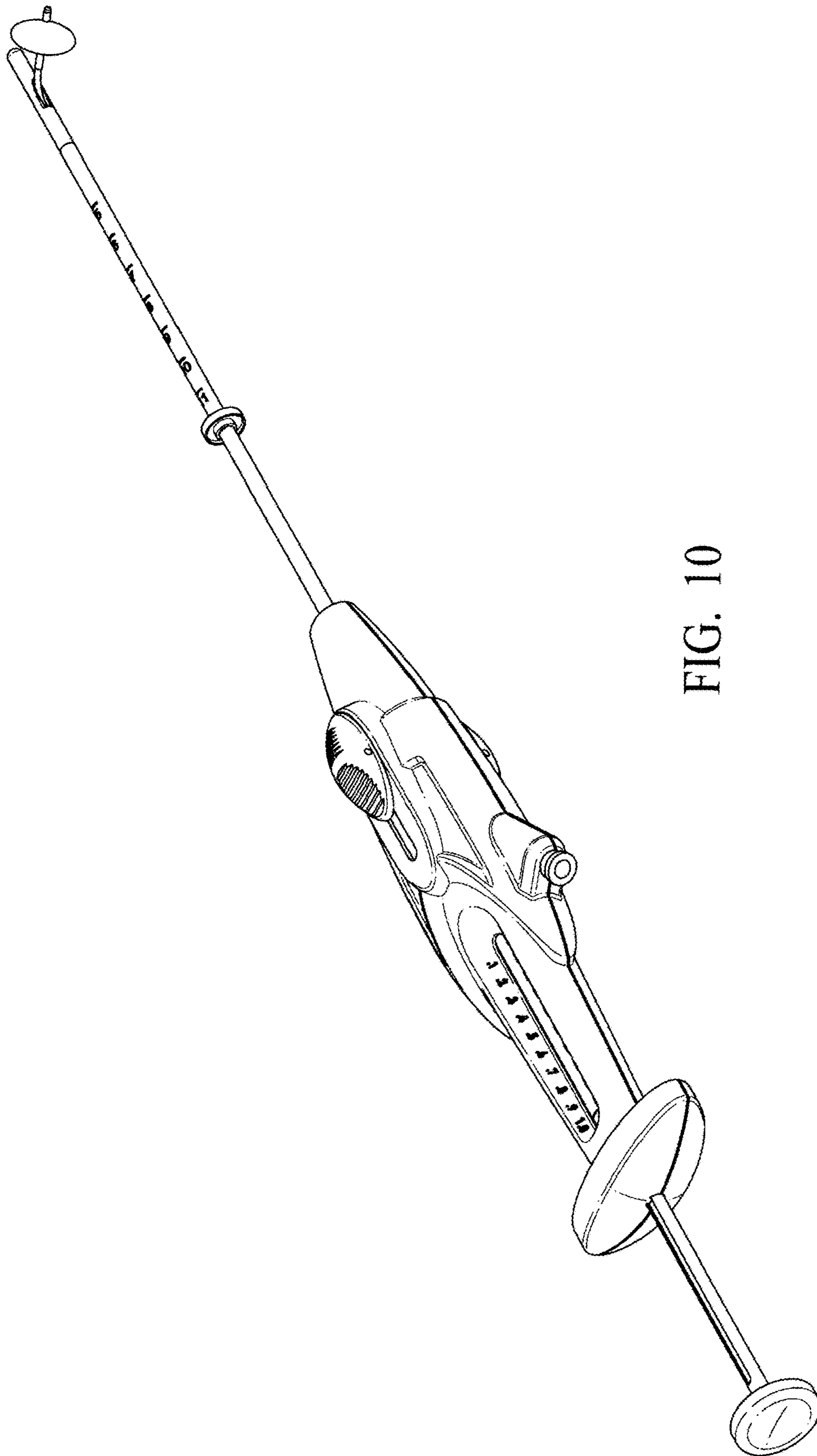

FIG. 10

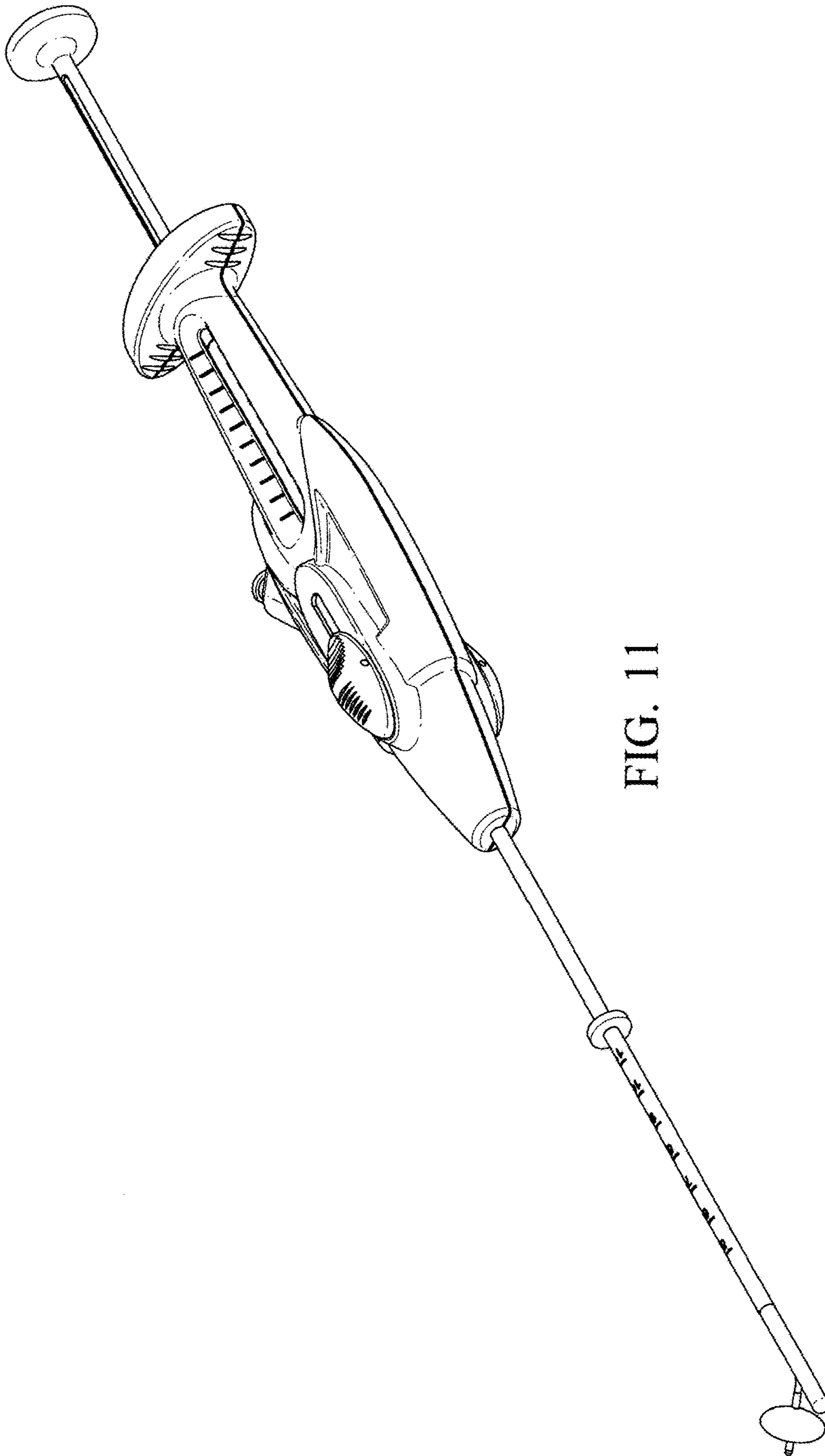

FIG. 11

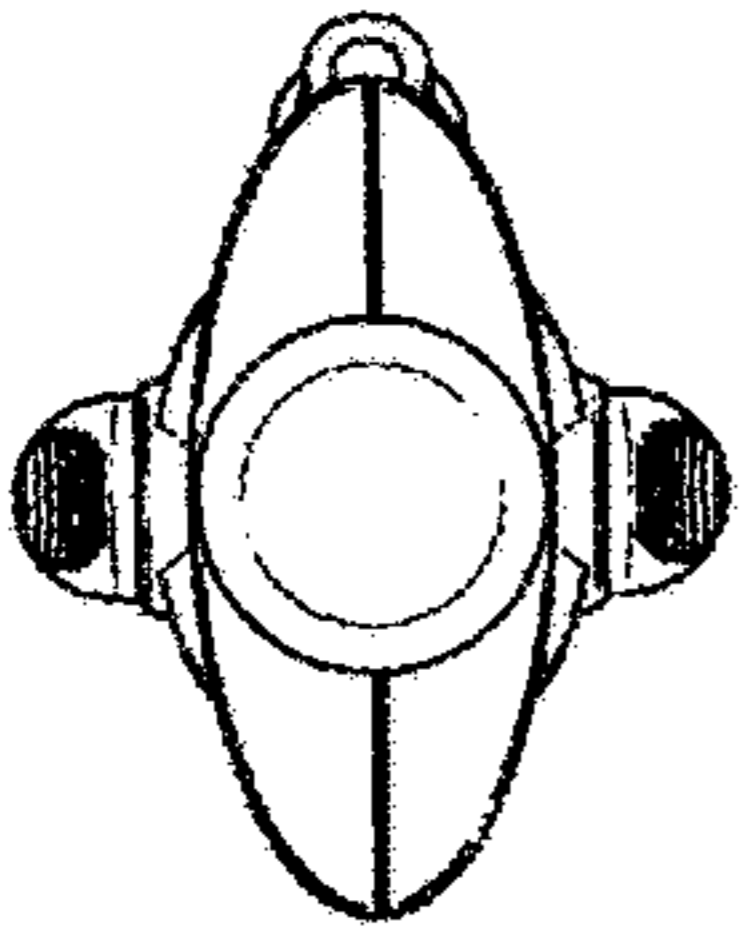

FIG. 12

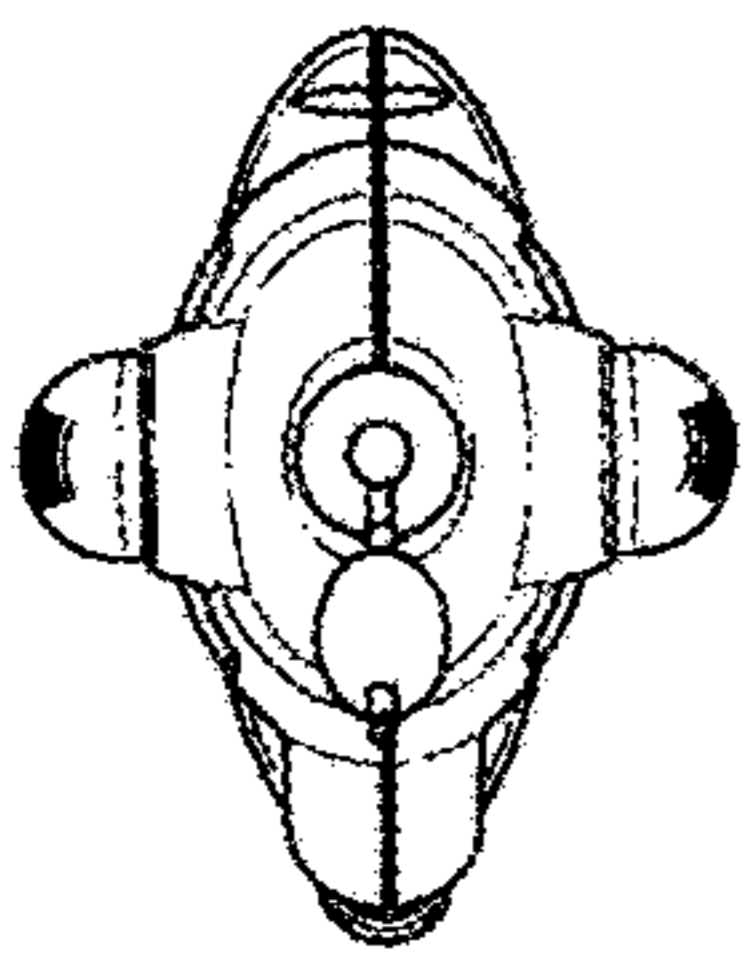

FIG. 13

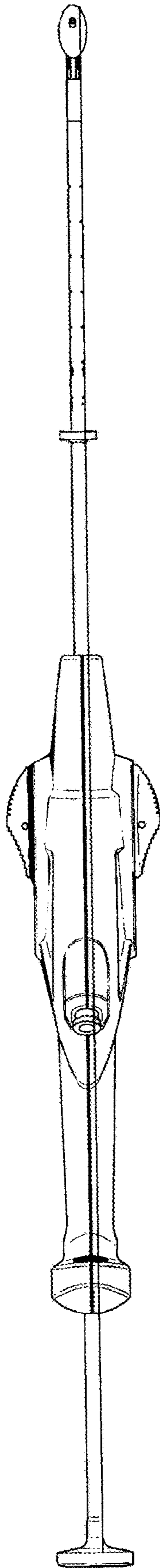

FIG. 14

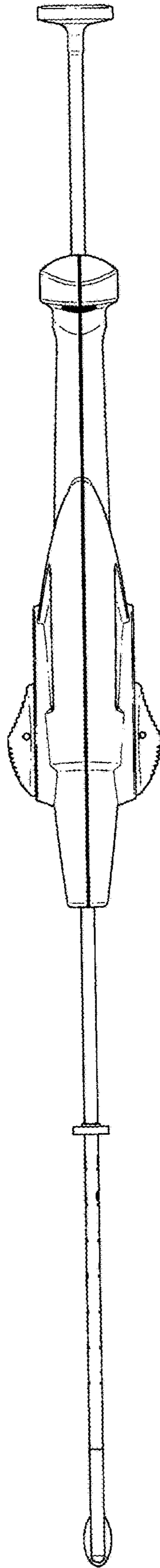

FIG. 15

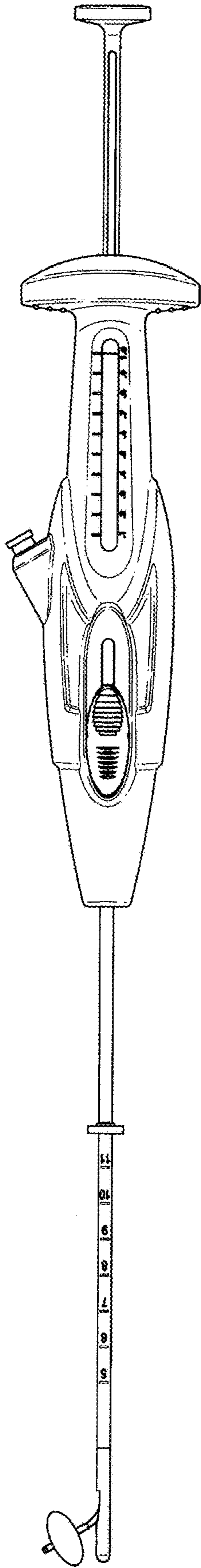

FIG. 16

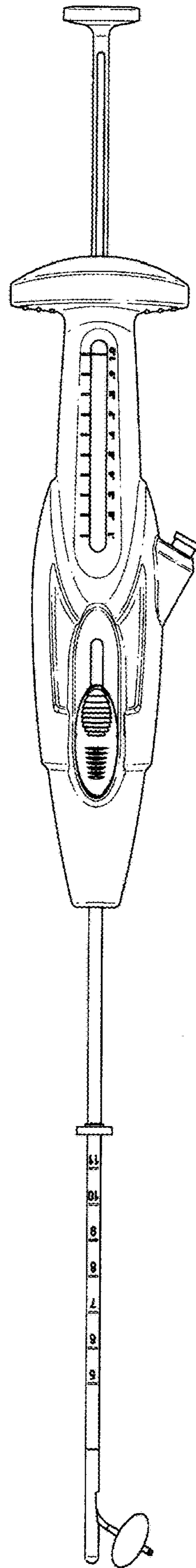

FIG. 17

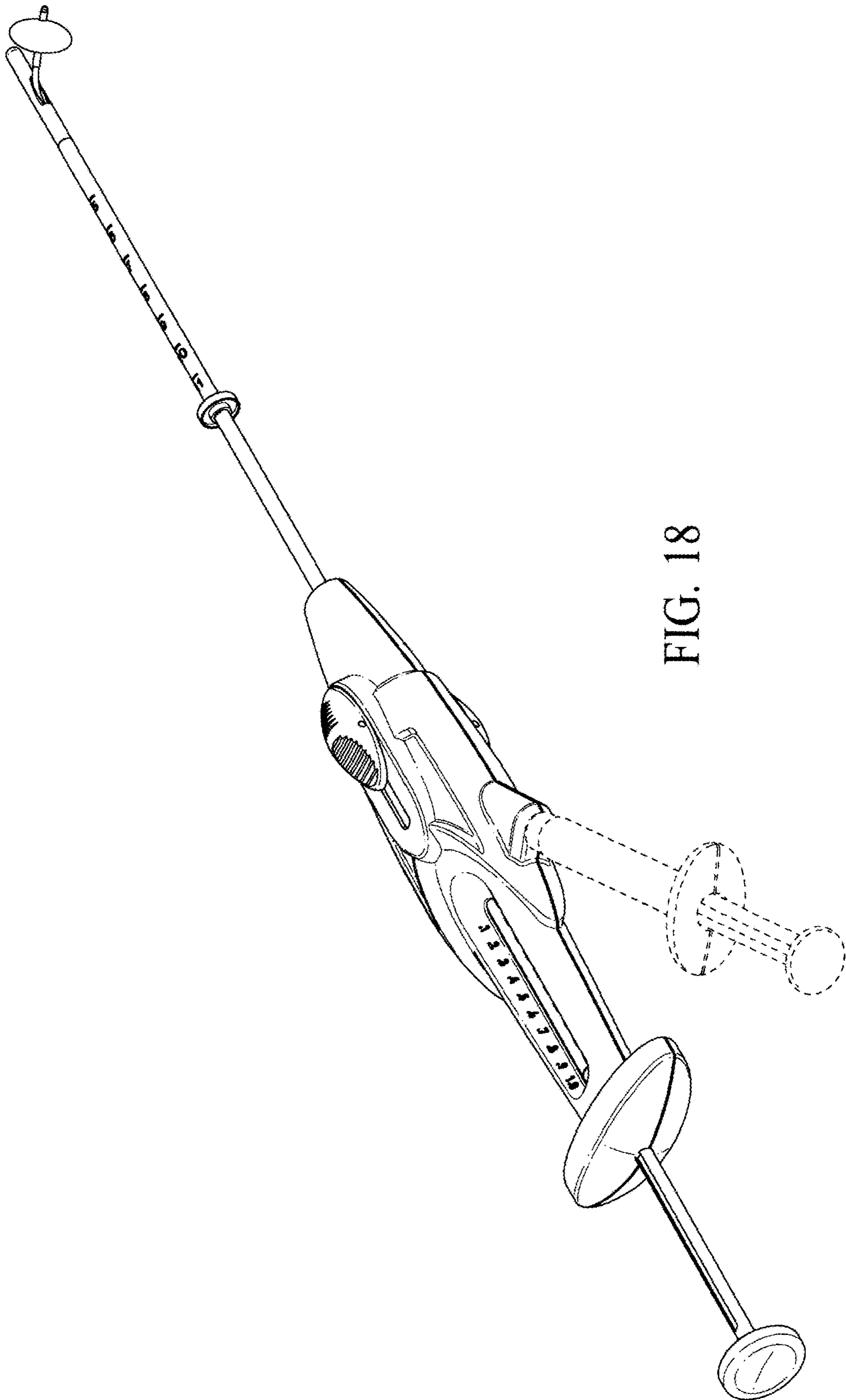

FIG. 18

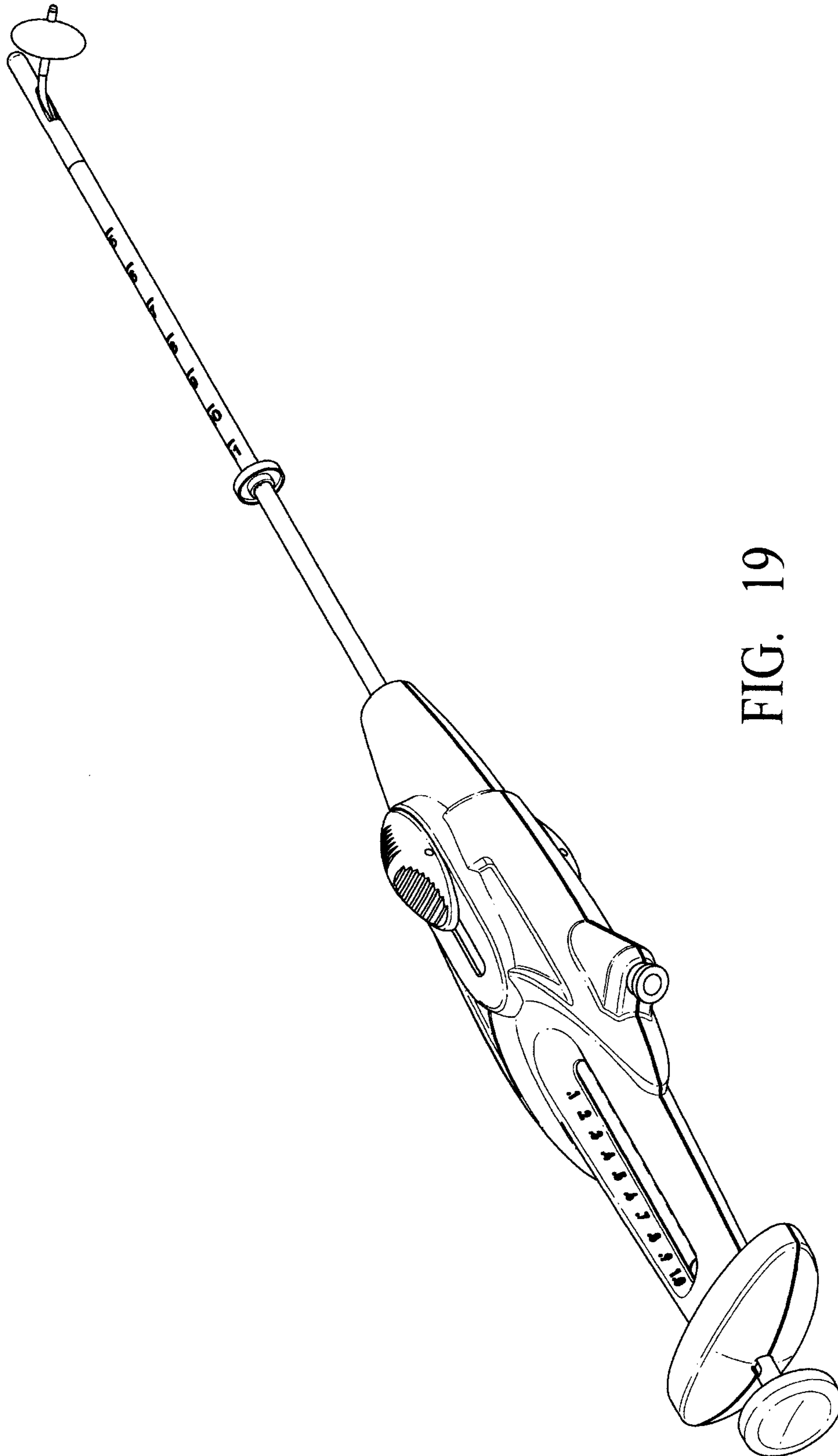

FIG. 19

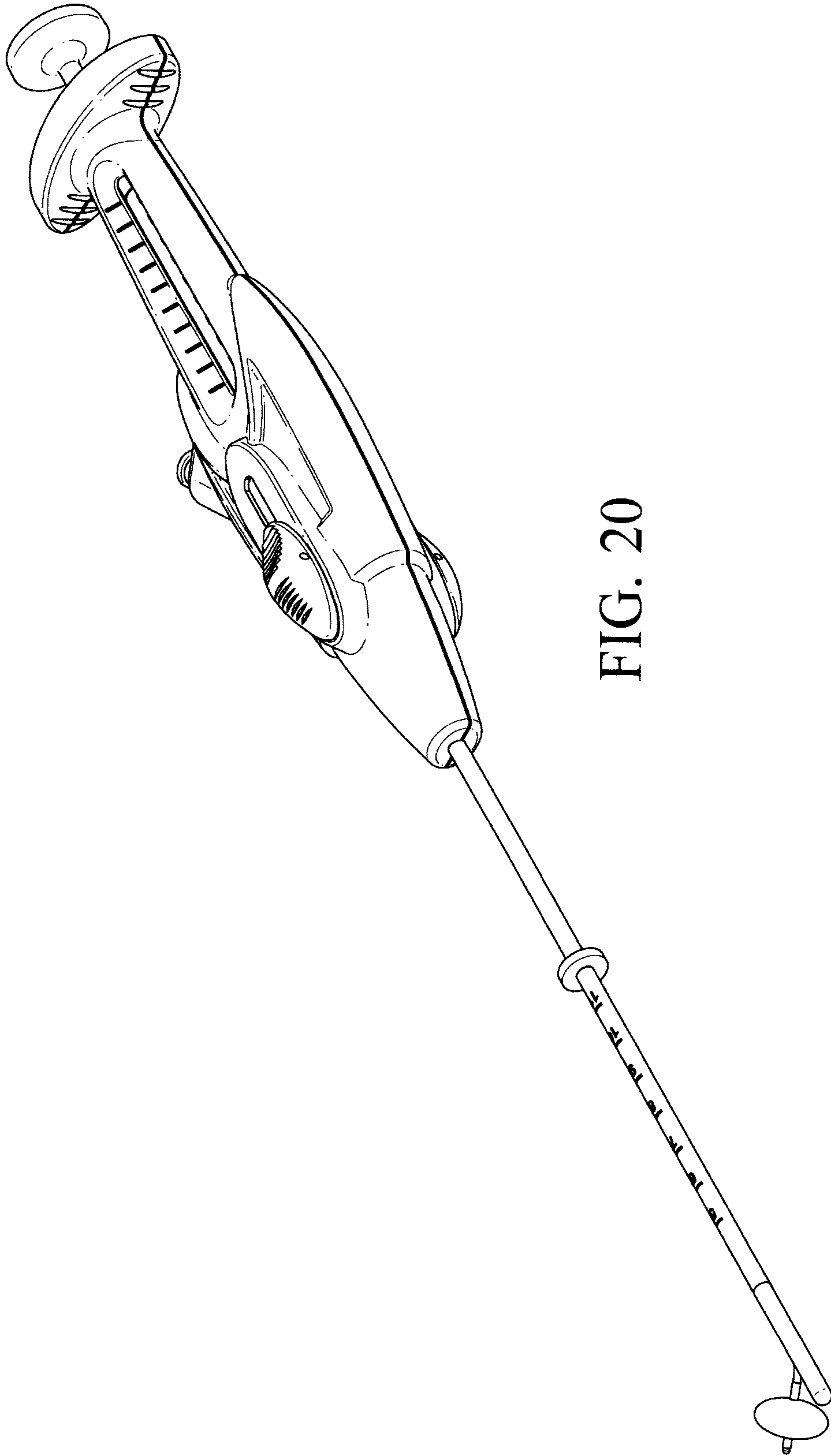

FIG. 20

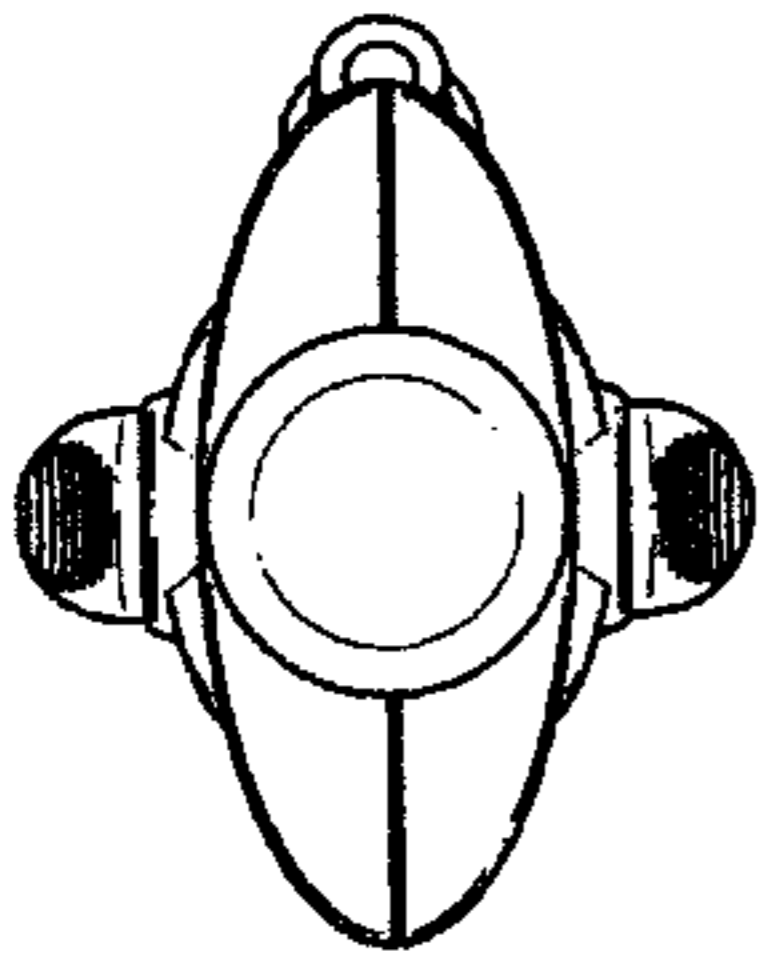

FIG. 21

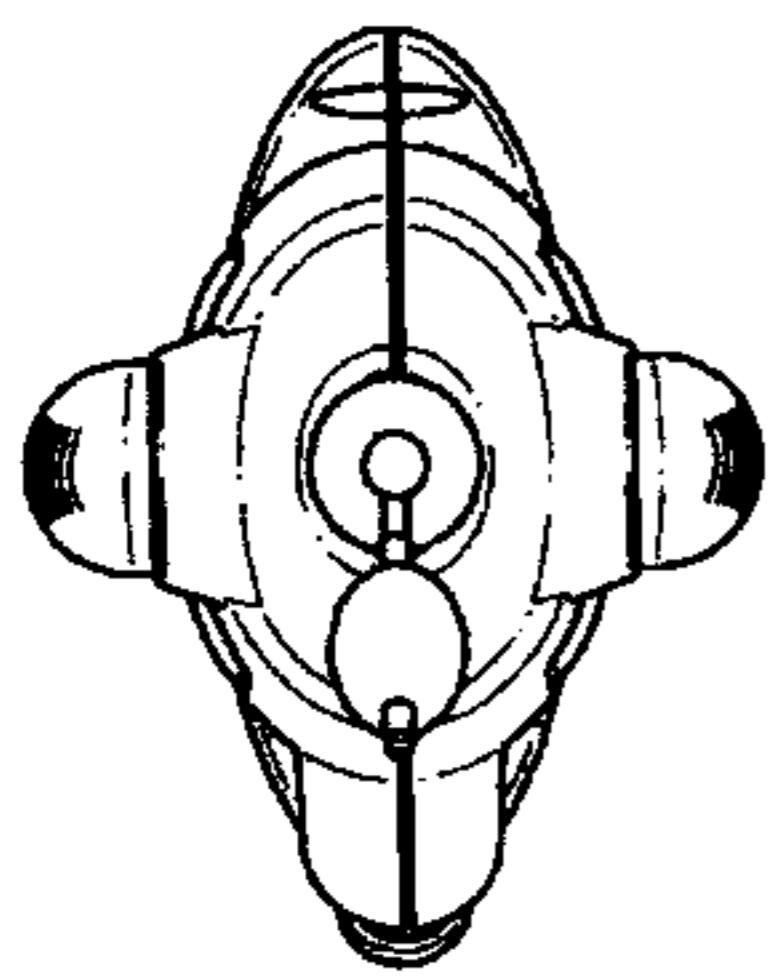

FIG. 22

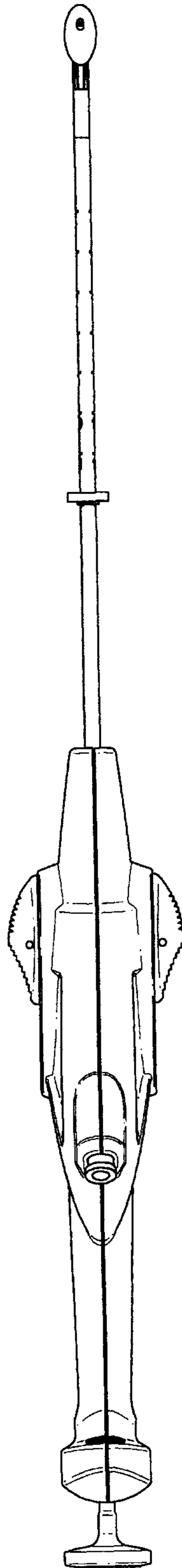

FIG. 23

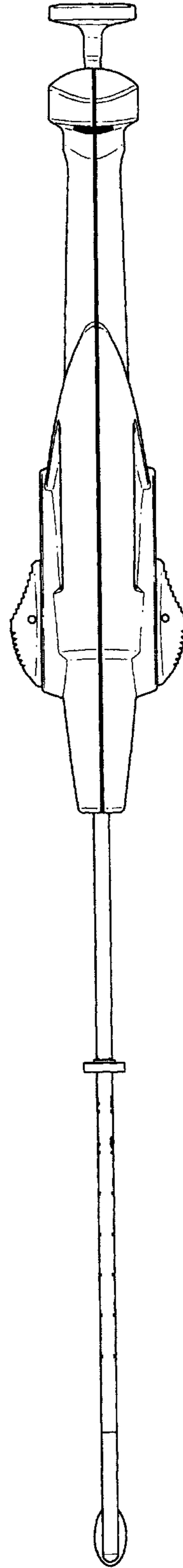

FIG. 24

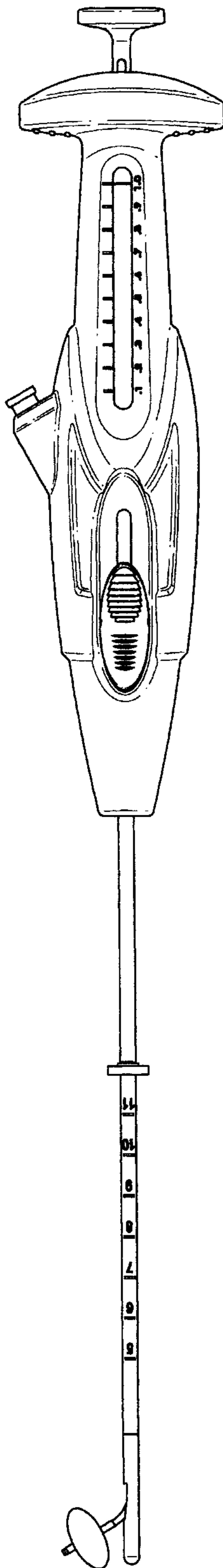

FIG. 25

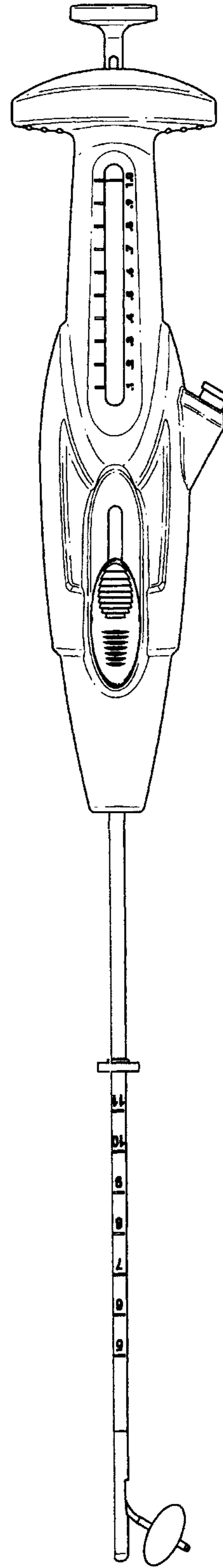

FIG. 26

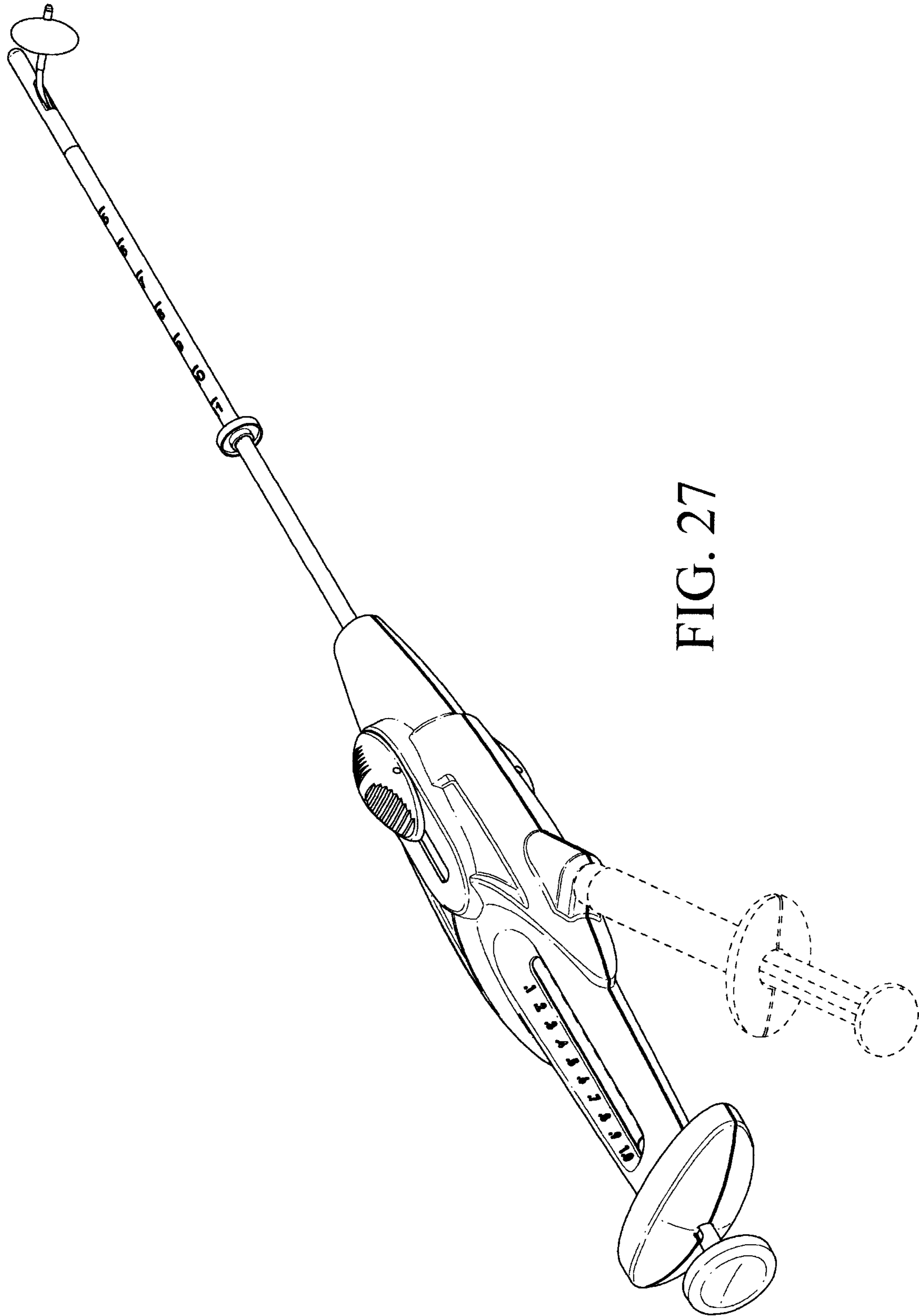

FIG. 27