



US00D912754S

(12) **United States Design Patent** (10) **Patent No.:** **US D912,754 S**
Katemann et al. (45) **Date of Patent:** **** Mar. 9, 2021**

(54) **WATERSPORT EQUIPMENT**

(71) Applicant: **Wibit Sports GmbH**, Bocholt (DE)
 (72) Inventors: **Mareen Katemann**, Borken (DE);
Robert Cirjak, Bocholt (DE); **Romann Rademacher**, Bocholt (DE)

(**) Term: **15 Years**

(21) Appl. No.: **35/507,755**

(22) Filed: **May 8, 2019**

(80) **Hague Agreement Data**

Int. Filing Date: **May 8, 2019**
 Int. Reg. No.: **DM/203836**
 Int. Reg. Date: **May 8, 2019**
 Int. Reg. Pub. Date: **Nov. 15, 2019**

(30) **Foreign Application Priority Data**

Nov. 8, 2018 (EM) 005820107-0032

(51) **LOC (13) Cl.** **21-02**

(52) **U.S. Cl.**
USPC **D21/803**

(58) **Field of Classification Search**

USPC D21/801, 803, 804, 805, 808, 809, 814,
 D21/815, 818, 819, 835
 CPC B63B 35/58; B63B 35/607; B63B 35/613;
 B63B 34/00; B63B 34/10; B63B 34/15;
 B63C 9/30

See application file for complete search history.

(56) **References Cited**

U.S. PATENT DOCUMENTS

D428,464 S *	7/2000	Peterson	D21/801
D801,466 S *	10/2017	Rademacher	D21/803
D824,467 S *	7/2018	Rademacher	D21/803
D824,468 S *	7/2018	Rademacher	D21/803
D850,556 S *	6/2019	Dumonceaux	D21/803
D851,192 S *	6/2019	Gardner	D21/803
D891,554 S *	7/2020	Rademacher	D21/803

* cited by examiner

Primary Examiner — George D. Kirschbaum

Assistant Examiner — Joseph J. Kukella

(57) **CLAIM**

The ornamental design for watersport equipment, as shown and described.

DESCRIPTION

1. Watersport equipment

1.1 : Perspective

1.2 : Front

1.3 : Bottom

1.4 : Back

1.5 : Left

1.6 : Right

1.7 : Top

The design shows a new, original and ornamental design for a watersport equipment as shown in the drawings.

1 Claim, 7 Drawing Sheets

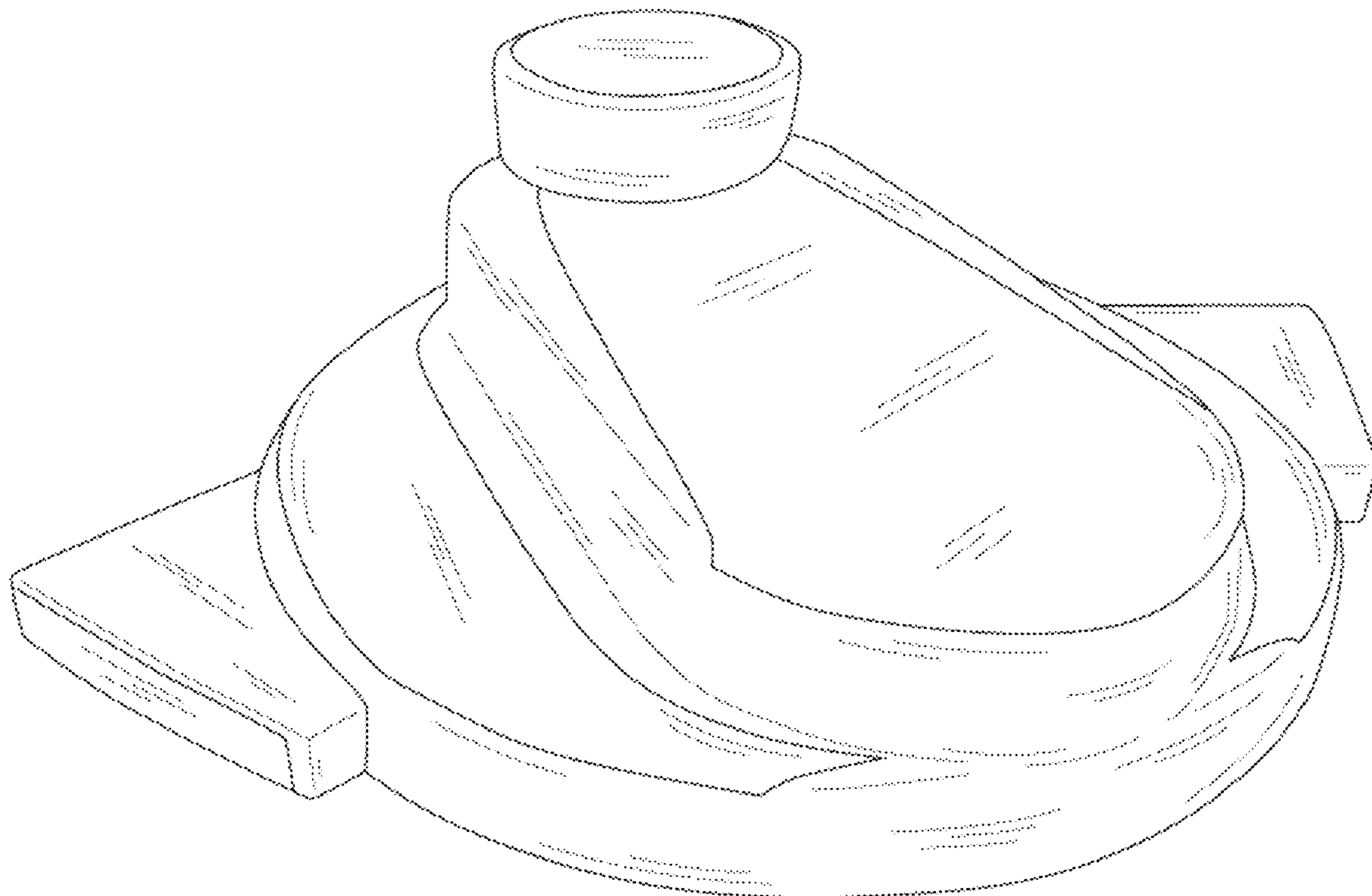

1.1

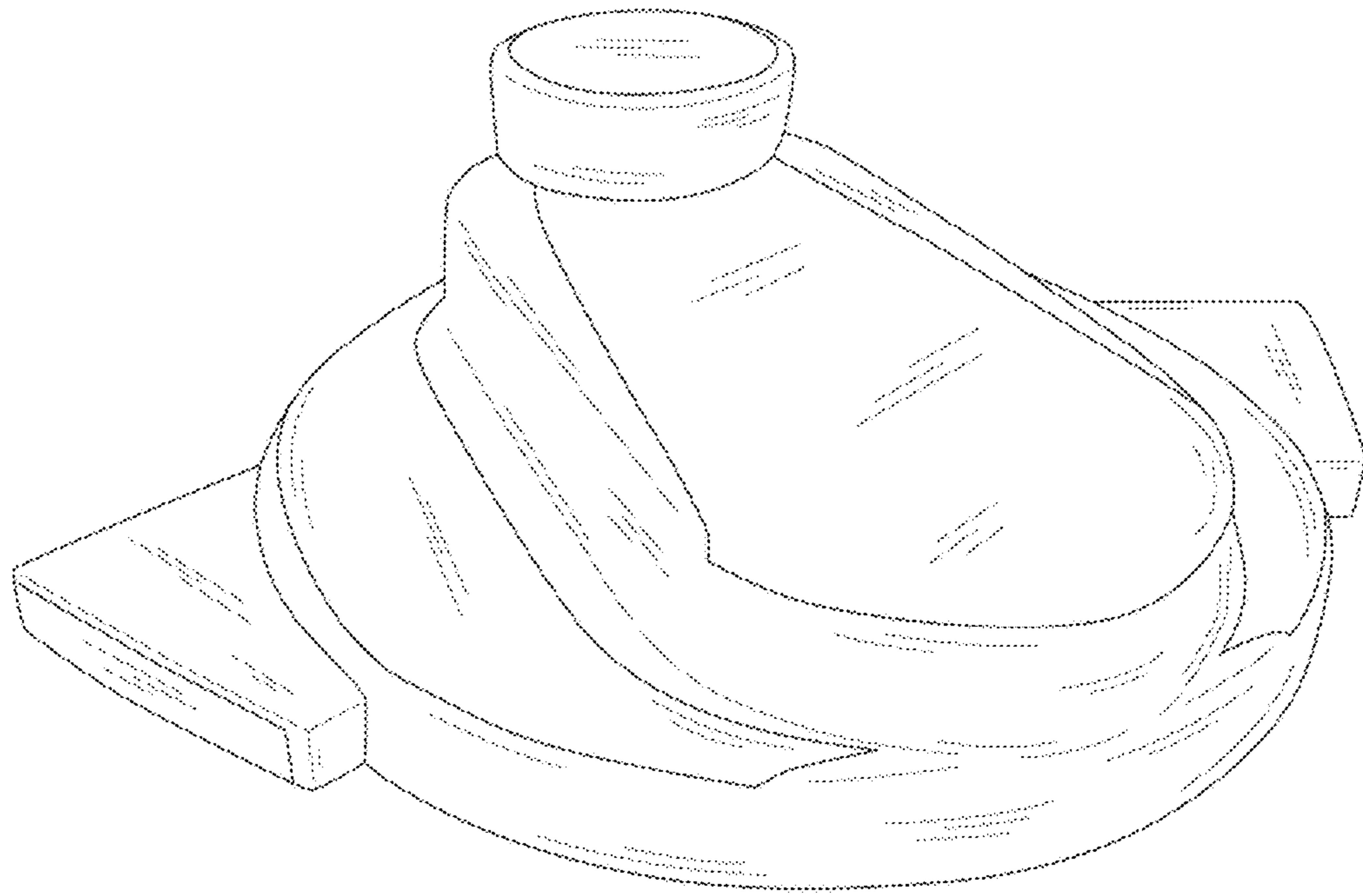

1.2

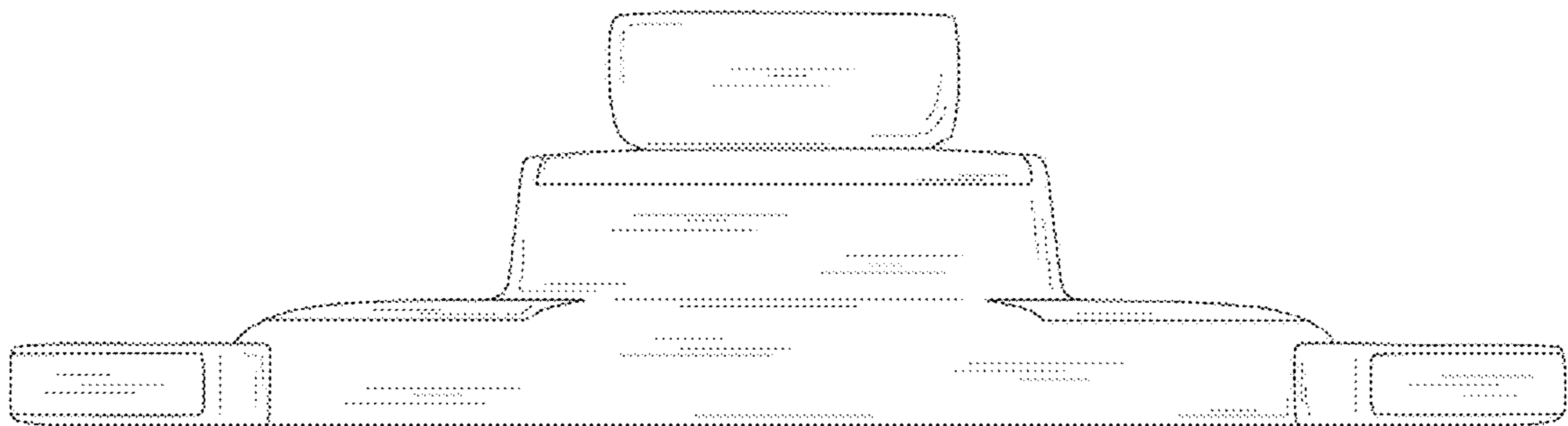

1.3

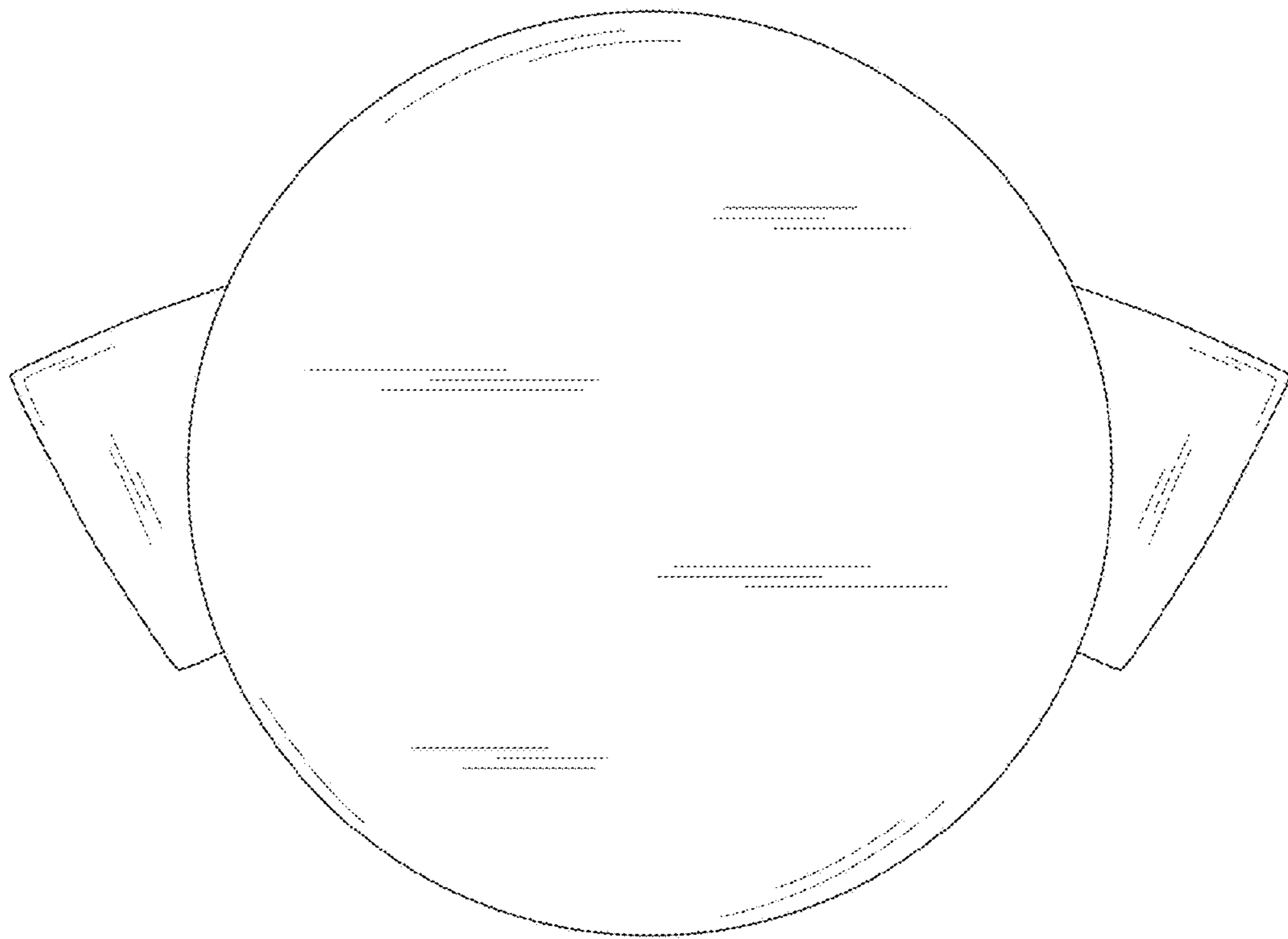

1.4

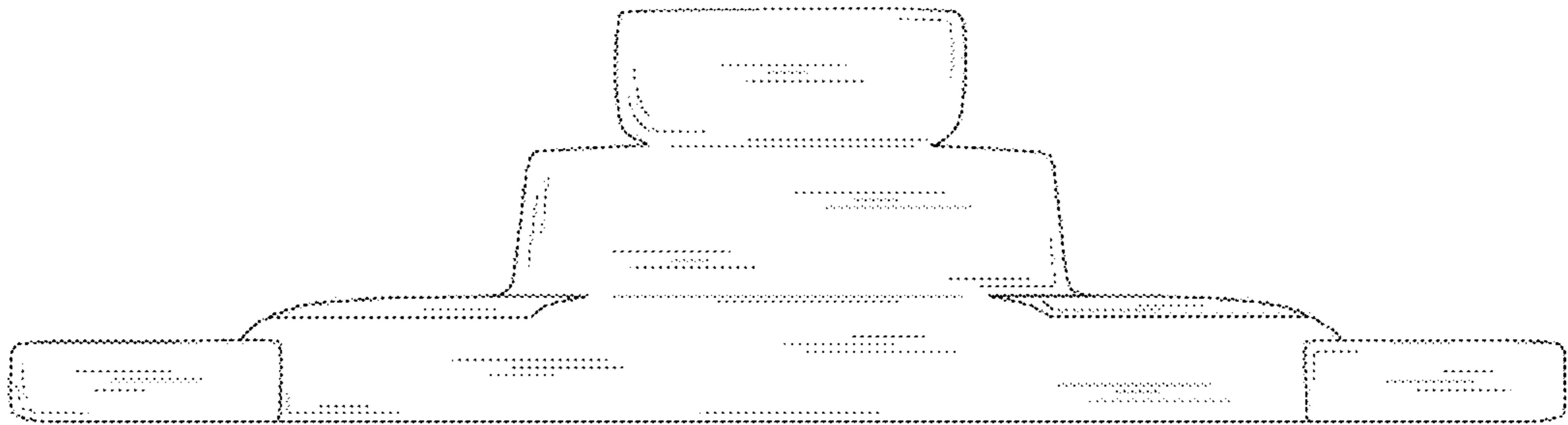

1.5

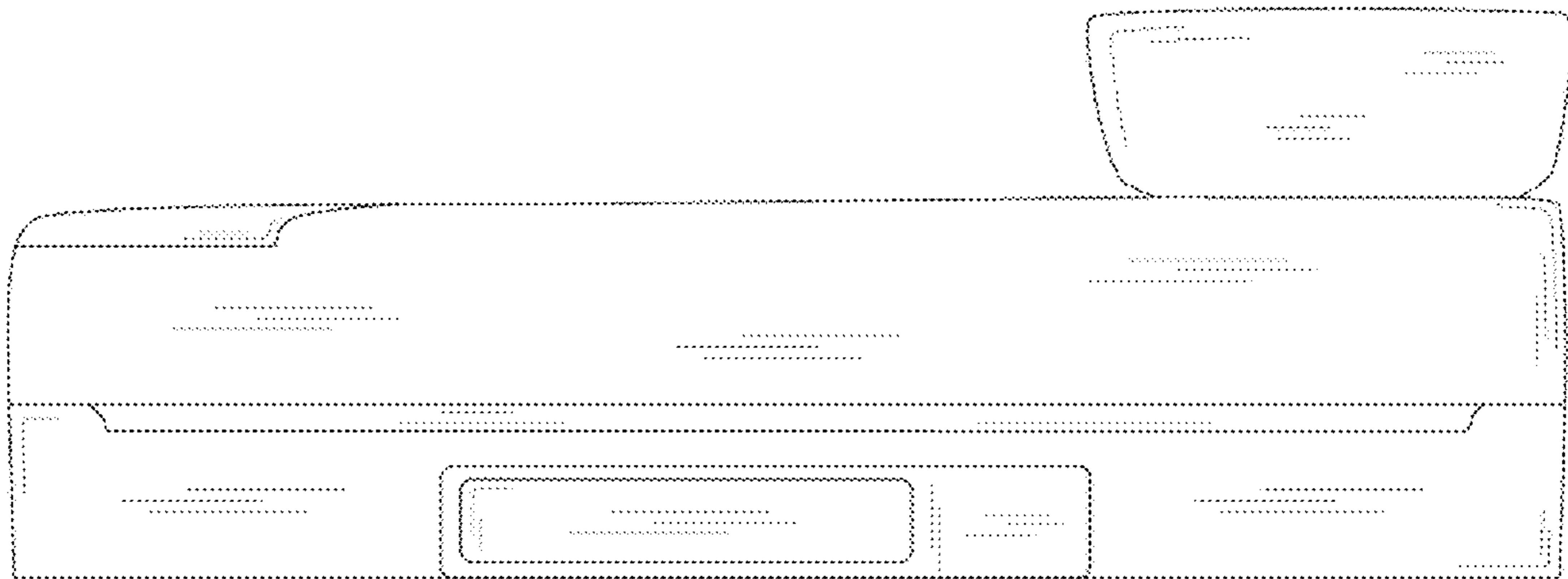

1.6

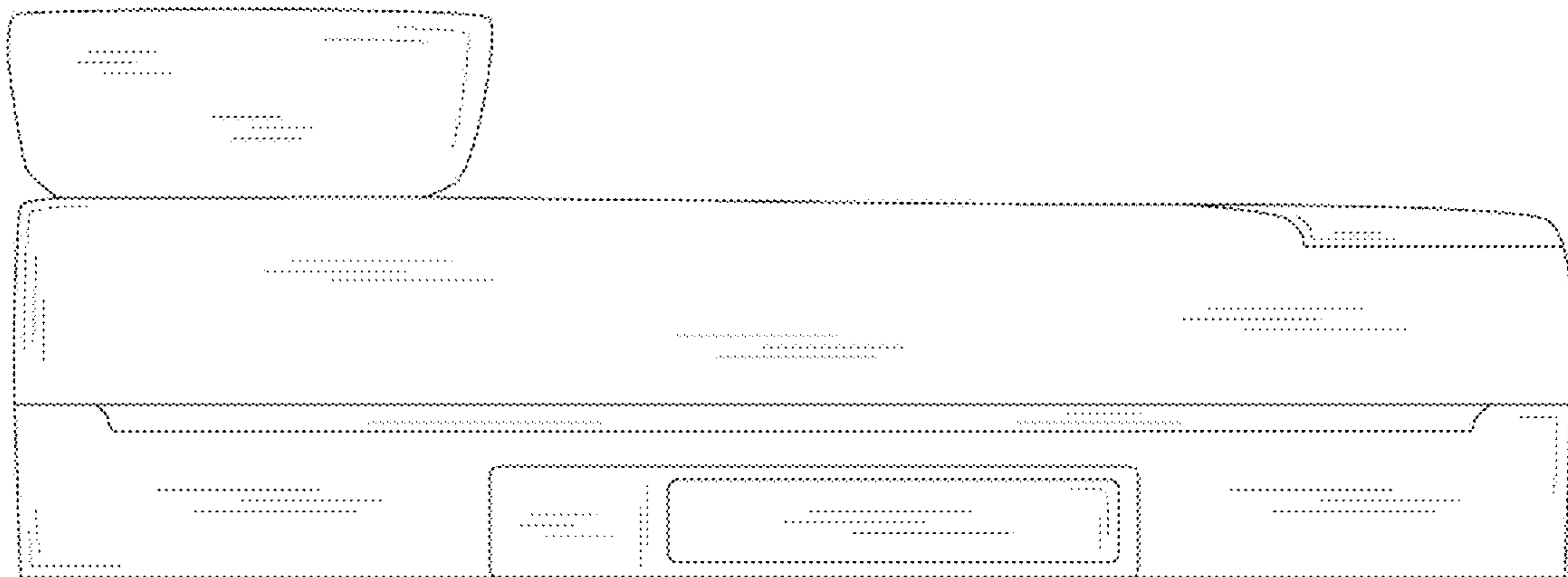

1.7

