

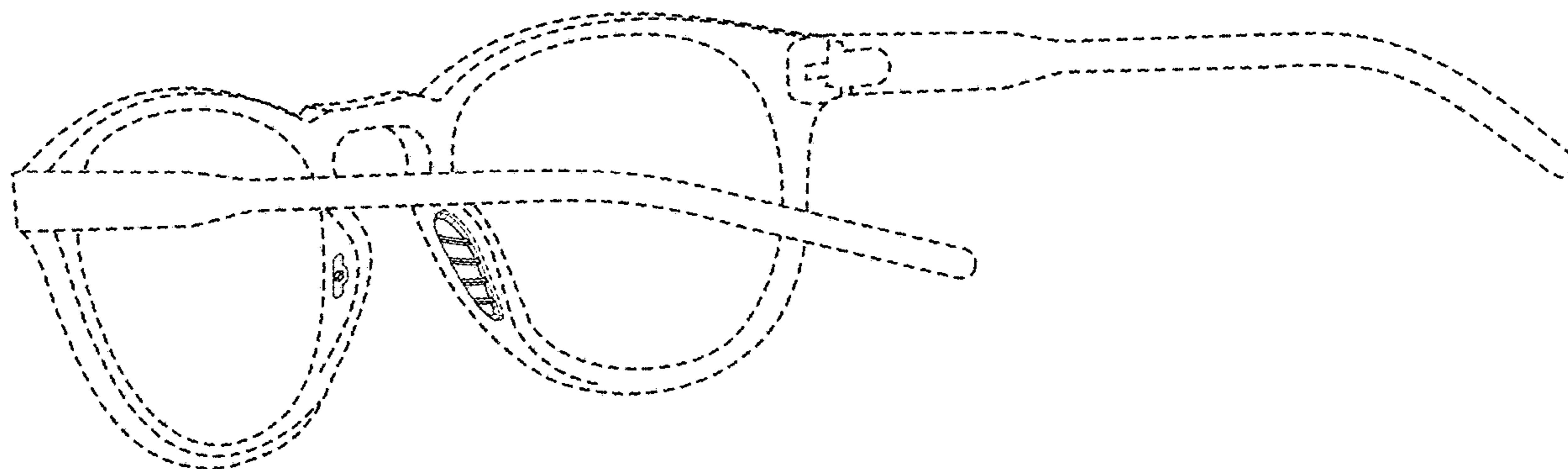

US00D912722S

(12) **United States Design Patent** (10) **Patent No.:** **US D912,722 S**  
**Canales et al.** (45) **Date of Patent:** **\*\* Mar. 9, 2021**

(54) <b>SNAP-IN NOSE PADS FOR EYEWEAR</b>	2,991,694 A *	7/1961 Whipple .....	G02C 5/12 351/91
(71) Applicant: <b>Roka Sports, Inc.</b> , Austin, TX (US)	3,186,001 A *	5/1965 Roeder .....	G02C 5/126 351/138
(72) Inventors: <b>Robert Canales</b> , Austin, TX (US); <b>Kurt Spenser</b> , Burbank, CA (US); <b>Tobin Rohrbach</b> , Trabuco Canyon, CA (US); <b>James Oman</b> , Austin, TX (US); <b>David Ginther</b> , Ladera Ranch, CA (US); <b>John Currie</b> , Orange, CA (US); <b>Steven Oldham</b> , Corona, CA (US); <b>Eric Suburu</b> , Tustin, CA (US); <b>Mark Niiro</b> , Dallas, TX (US); <b>Tet Kawakami</b> , Austin, TX (US)	4,070,104 A * 4,251,302 A * 4,732,464 A * 4,802,754 A 4,924,245 A 4,964,716 A *	1/1978 Rice .....	G02C 5/126 351/132
(73) Assignee: <b>Roka Sports, Inc.</b> , Austin, TX (US)		2/1981 Leonard .....	G02C 5/00 156/329
(**) Term: <b>15 Years</b>		3/1988 Bononi .....	G02C 5/126 351/132
(21) Appl. No.: <b>29/643,342</b>		2/1989 Neef	
(22) Filed: <b>Apr. 6, 2018</b>		5/1990 Dianitsch	
(51) <b>LOC (13) Cl.</b> .....		10/1990 Combs .....	G02C 5/126 351/139
(52) <b>U.S. Cl.</b>		D330,035 S	10/1992 Jannard
USPC .....		D330,903 S	11/1992 Jannard
(58) <b>Field of Classification Search</b>		D342,959 S	1/1994 Jannard
USPC .....		D344,742 S	3/1994 Jannard
351/43, 44-47, 49, 59, 63, 69, 104, 123, 351/126, 131, 132, 135, 145; D16/101, D16/300-342; D29/108-110; D14/372		D350,759 S	9/1994 Lanna et al.
CPC .....		5,387,949 A *	2/1995 Tackles
G02C 5/22; G02C 5/2218; G02C 5/2236; G02C 5/2245; G02C 5/2254; G02C 5/2272; G02C 5/14; G02C 5/143; G02C 5/146; G02C 5/18; G02C 5/20; G02C 5/12; G02C 5/124; G02C 5/126; G02C 11/02; G02C 11/06; G02C 7/10; G02C 9/04; A61F 9/00		5,457,506 A	10/1995 Winkler
See application file for complete search history.		D366,056 S *	1/1996 Wolfe .....
		5,646,707 A	7/1997 Arnette
(56) <b>References Cited</b>		D385,897 S	11/1997 Lin
<b>U.S. PATENT DOCUMENTS</b>		D386,777 S	11/1997 Hall et al.
2,216,503 A *		D399,519 S	10/1998 Yee
10/1940 Ring .....		D416,276 S	11/1999 Chiu
G02C 5/126 351/78		6,056,399 A	5/2000 Jannard et al.
2,463,041 A *		6,059,408 A	5/2000 Bonacci
3/1949 Malcom .....		6,283,594 B1 *	9/2001 Hamano .....
G02C 5/12 351/136		D462,081 S	8/2002 Wolfe
		6,513,925 B1	2/2003 Bonacci
		6,554,422 B2	4/2003 Bell et al.
		D475,733 S *	6/2003 Lee .....
		6,644,806 B2	11/2003 Wu
		D485,856 S *	1/2004 Wolfe .....
		D502,494 S	3/2005 Yang
		6,929,364 B1	8/2005 Jannard
		D516,111 S *	2/2006 Teng .....
		D518,083 S *	3/2006 Teng .....
		D518,084 S	3/2006 Teng
		7,040,753 B2 *	5/2006 Aylor .....
		D535,318 S *	1/2007 Teng .....
		D534,572 S *	2/2007 Teng
		D540,368 S *	4/2007 Yang .....
		D549,763 S *	8/2007 Daems .....
		D550,755 S	9/2007 Fuchs
		D550,758 S *	9/2007 Cheng .....
		D552,663 S *	10/2007 Cheng .....
		D555,707 S	11/2007 Hou
		D555,708 S	11/2007 Cheng



D559,888	S	1/2008	Yang	
7,347,545	B1	3/2008	Jannard et al.	
D565,639	S	4/2008	Estrem	
D569,412	S	5/2008	Jannard et al.	
7,380,933	B1 *	6/2008	Wang	
7,380,934	B1 *	6/2008	Wang Lee	
D575,325	S	8/2008	Wu	
7,452,068	B2	11/2008	Collier et al.	
D583,852	S	12/2008	Chen	
7,484,843	B1 *	2/2009	Lin	G02C 5/126 351/136
D591,329	S	4/2009	Wang	
D595,757	S *	7/2009	Yang	D16/314
D609,736	S *	2/2010	Wang	D16/326
D611,980	S	3/2010	Chen	
D614,226	S	4/2010	Fulton et al.	
D614,359	S	4/2010	Gleason et al.	
D615,578	S	5/2010	Pulito et al.	
D617,364	S *	6/2010	Chou	D16/315
D625,351	S *	8/2010	Wong	
D623,218	S *	9/2010	Wong	D16/332
D636,808	S *	4/2011	Sheldon	
D637,643	S	5/2011	Lebel	
D640,314	S	6/2011	Yang	
D641,391	S	7/2011	Sheldon	
D651,641	S *	1/2012	Fulton	D16/333
D651,642	S	1/2012	Fuchs	
D652,858	S	1/2012	Lamontagne	
D659,180	S	5/2012	Moritz	
D659,746	S	5/2012	Chen	
8,403,477	B2	3/2013	Ogren	
D679,313	S	4/2013	Bachelor	
D683,784	S	6/2013	Miera	
D690,762	S *	10/2013	Yang	D16/315
D694,312	S	11/2013	Mage	
D695,336	S	12/2013	Wang	
D727,399	S	4/2015	Markovitz et al.	
D730,434	S	5/2015	Chen	
D735,794	S	8/2015	Markovitz et al.	
D740,347	S *	10/2015	Corcoran	D16/326
D757,156	S	5/2016	Wu	
D765,765	S	9/2016	Clegg	
D770,560	S	11/2016	Shin	
D775,685	S	1/2017	Rouayroux et al.	
D777,827	S	1/2017	Chen	
D783,080	S	4/2017	Garfias	
9,651,798	B1 *	5/2017	Fujimura	G02C 5/008
D797,183	S *	9/2017	Flake	
D798,375	S *	9/2017	Flake	D16/332
D809,056	S *	1/2018	Flake	D16/330
10,018,852	B2 *	7/2018	Hamilton	G02C 5/124
D835,178	S *	12/2018	Miera	D16/314
D837,871	S *	1/2019	Canales	D16/314
D842,921	S *	3/2019	Sanchez	
D849,823	S *	5/2019	Canales	D16/313
D849,825	S *	5/2019	Canales	D16/314
D850,523	S *	6/2019	Yang	
D851,165	S *	6/2019	Sanchez	
10,394,049	B2 *	8/2019	Canales	G02C 1/06
D870,802	S *	12/2019	Canales	D16/315
D871,497	S *	12/2019	Canales	D16/335
D888,144	S *	6/2020	Sanchez	D16/330
D889,531	S *	7/2020	Canales	D16/330
D890,247	S *	7/2020	Yang	
2006/0238697	A1 *	10/2006	Teng	
2007/0236649	A1 *	10/2007	Lin	G02C 5/02 351/41
2008/0074610	A1	3/2008	Tackles	
2008/0170200	A1	7/2008	Chen	
2011/0025974	A1 *	2/2011	Schepke	
2014/0340628	A1	11/2014	Huang	
2015/0314167	A1	11/2015	Shiue	
2017/0100287	A1	4/2017	Calilung et al.	
2018/0008467	A1	1/2018	Cater et al.	
2018/0031862	A1	2/2018	Li	

FOREIGN PATENT DOCUMENTS

DE	3707297	A1	9/1988
DE	4019085	A1	5/1991
EP	0239659	B1	1/1992
FR	2631464	A1	11/1989
FR	2770309	A1	4/1999
JP	S61126225	U	8/1986
JP	S63122322	U	8/1988
JP	H0192627	U	6/1989
JP	H0329629	U	3/1991
JP	4944087	B2	5/2012
WO	WO-03062904	A1	7/2003
WO	WO-2012033691	A1	3/2012

OTHER PUBLICATIONS

Roka:Braker, announced unknown, [online], [site visited Nov. 5, 2020]. Available from Internet, <URL: <https://www.roka.com/collections/ultralight-modern-classics-sunglasses/products/braker>> (Year: 2020).\*

Google search: “sports eyeglasses nose pads” [site visited Nov. 5, 2020]: [https://www.google.com/search?q=sports+eyeglasses+nose+pads&hl=en&sxsrf=ALeKk00pza8AcoTKxrL1Hi8d-Sqv0ZY9nQ:1603430256892&source=Inms&tbm=isch&sa=X&ved=2ahUKEwi-gImX-8nsAhUggXIEHYrIAuQQ\\_AUoAnoECCcQBA&biw=1200&bih=1777](https://www.google.com/search?q=sports+eyeglasses+nose+pads&hl=en&sxsrf=ALeKk00pza8AcoTKxrL1Hi8d-Sqv0ZY9nQ:1603430256892&source=Inms&tbm=isch&sa=X&ved=2ahUKEwi-gImX-8nsAhUggXIEHYrIAuQQ_AUoAnoECCcQBA&biw=1200&bih=1777) (Year: 2020).\*

Google search: “nose pads for glasses” [site visited Nov. 5, 2020]: [https://www.google.com/search?q=nose+pads+for+glasses&sxsrf=ALeKk01heHCAeFbhgW5JMRdMdXw-zbU8XQ:1604612762789&source=Inms&tbm=isch&sa=X&ved=2ahUKEwitgumtsOzsAhVxq3IEHbVnBJMQ\\_AUoAnoECC8QBA&biw=1200&bih=1777](https://www.google.com/search?q=nose+pads+for+glasses&sxsrf=ALeKk01heHCAeFbhgW5JMRdMdXw-zbU8XQ:1604612762789&source=Inms&tbm=isch&sa=X&ved=2ahUKEwitgumtsOzsAhVxq3IEHbVnBJMQ_AUoAnoECC8QBA&biw=1200&bih=1777) (Year: 2020).\*

Co-pending U.S. Appl. No. 16/157,972, filed Oct. 11, 2018.  
 Co-pending U.S. Appl. No. 29/658,437, filed Jul. 31, 2018.  
 Co-pending U.S. Appl. No. 29/616,066, filed Sep. 1, 2017.  
 Co-pending U.S. Appl. No. 29/640,311, filed Mar. 13, 2018.  
 Co-pending U.S. Appl. No. 29/640,312, filed Mar. 13, 2018.  
 Co-pending U.S. Appl. No. 29/642,302, filed Mar. 28, 2018.  
 Co-pending U.S. Appl. No. 29/643,339, filed Apr. 6, 2018.  
 U.S. Appl. No. 29/562,636 Office Action dated Jun. 30, 2017.  
 U.S. Appl. No. 29/562,638 Ex Parte Quayle dated Apr. 6, 2017.  
 U.S. Appl. No. 29/562,643 Office Action dated Apr. 20, 2017.  
 U.S. Appl. No. 29/616,066 Ex Parte Quayle dated Jul. 11, 2018.

\* cited by examiner

Primary Examiner — Sanjeev Paul  
 (74) Attorney, Agent, or Firm — Clearpat Services, LLC;  
 Brian B. Burkinshaw

(57) CLAIM

The ornamental design for a snap-in nose pads for eyewear, as shown and described.

DESCRIPTION

FIG. 1 is a perspective view of the snap-in nose pads for eyewear, showing our new design shown in a state of use; FIG. 2 is a top view thereof; FIG. 3 is a front elevation view thereof; FIG. 4 is a rear elevation view thereof; FIG. 5 is a bottom plan view thereof; FIG. 6 is a front elevation view thereof; FIG. 7 is a side elevation thereof; and, FIG. 8 is a rear view thereof.

The broken lines shown in the drawings are included for the purpose of illustrating environmental subject matter and form no part of the claimed design.

**1 Claim, 4 Drawing Sheets**

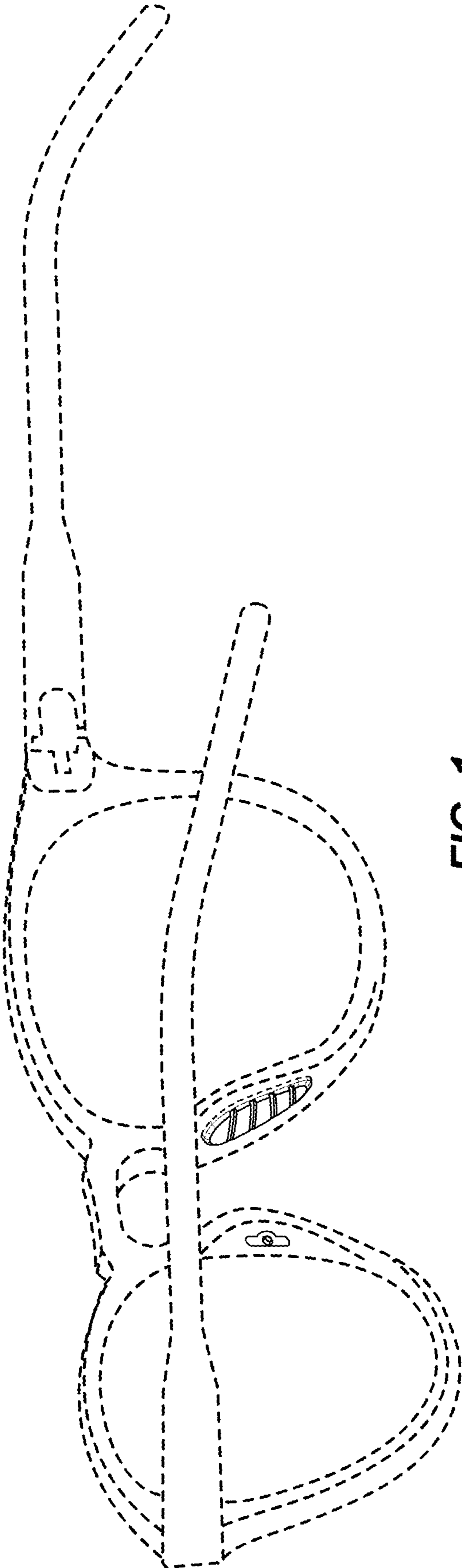
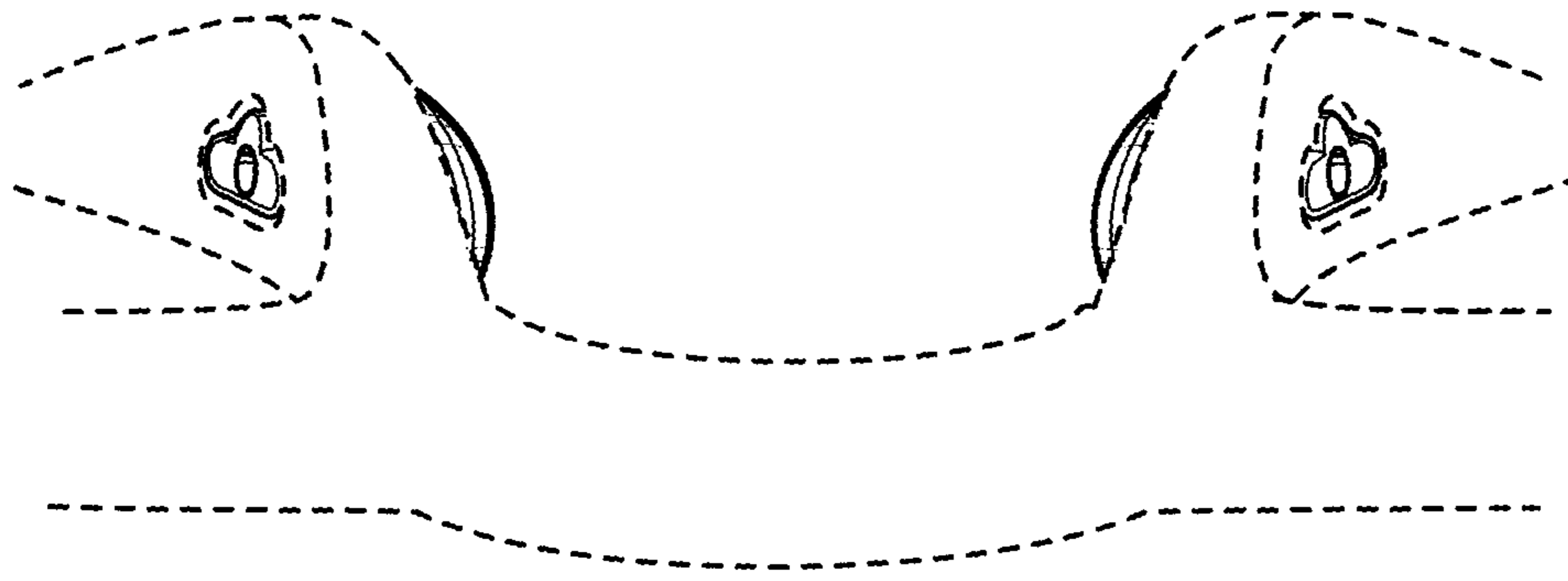
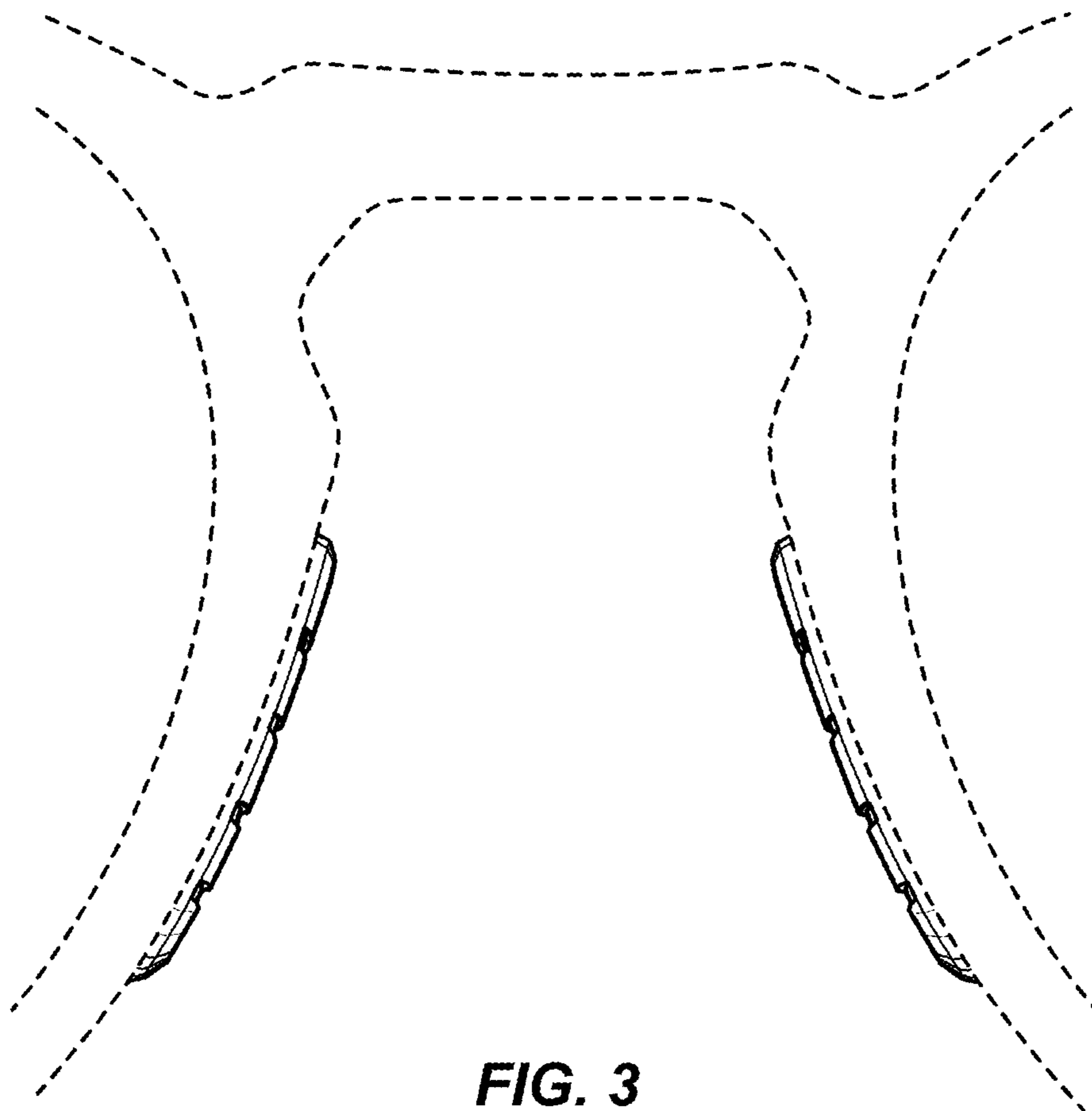

FIG. 1



**FIG. 2**



**FIG. 3**

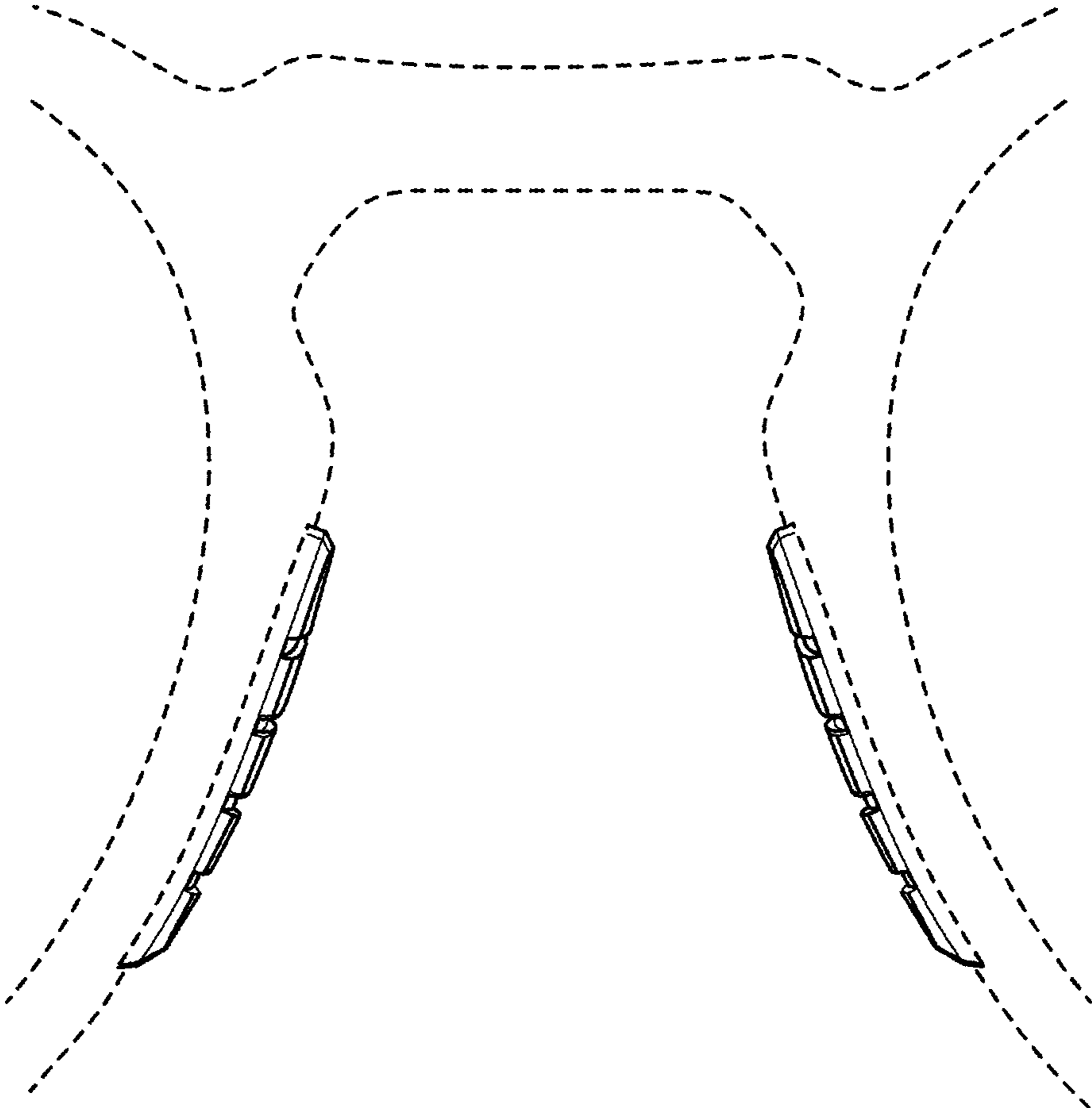

**FIG. 4**

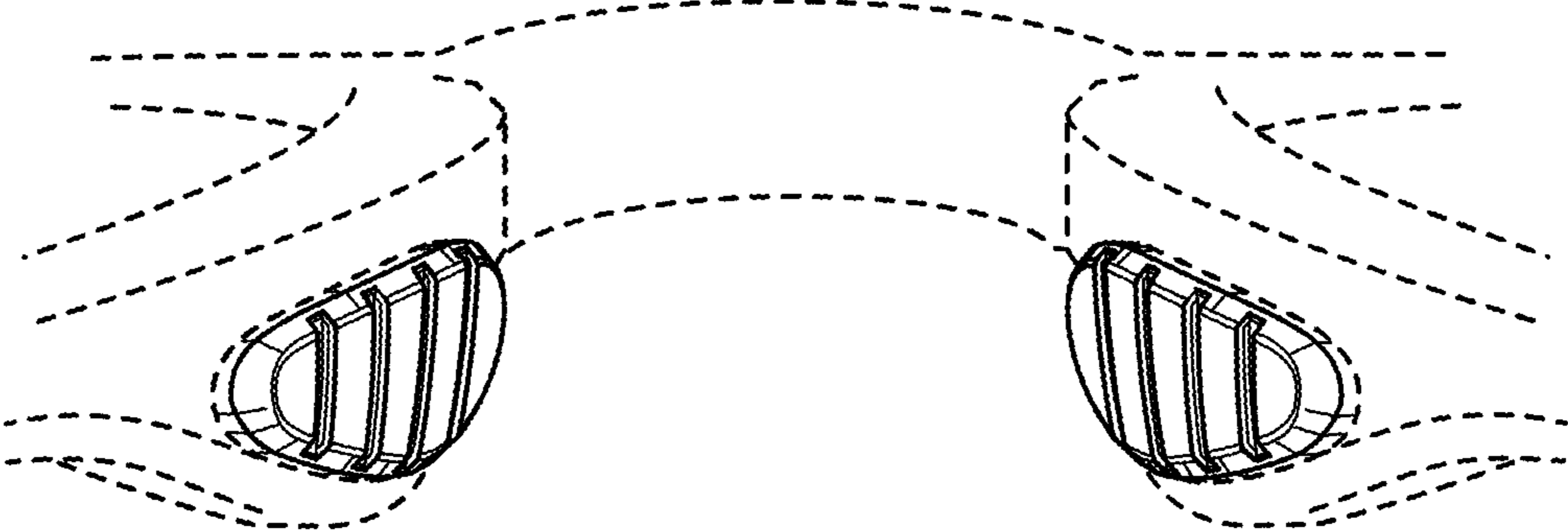

**FIG. 5**

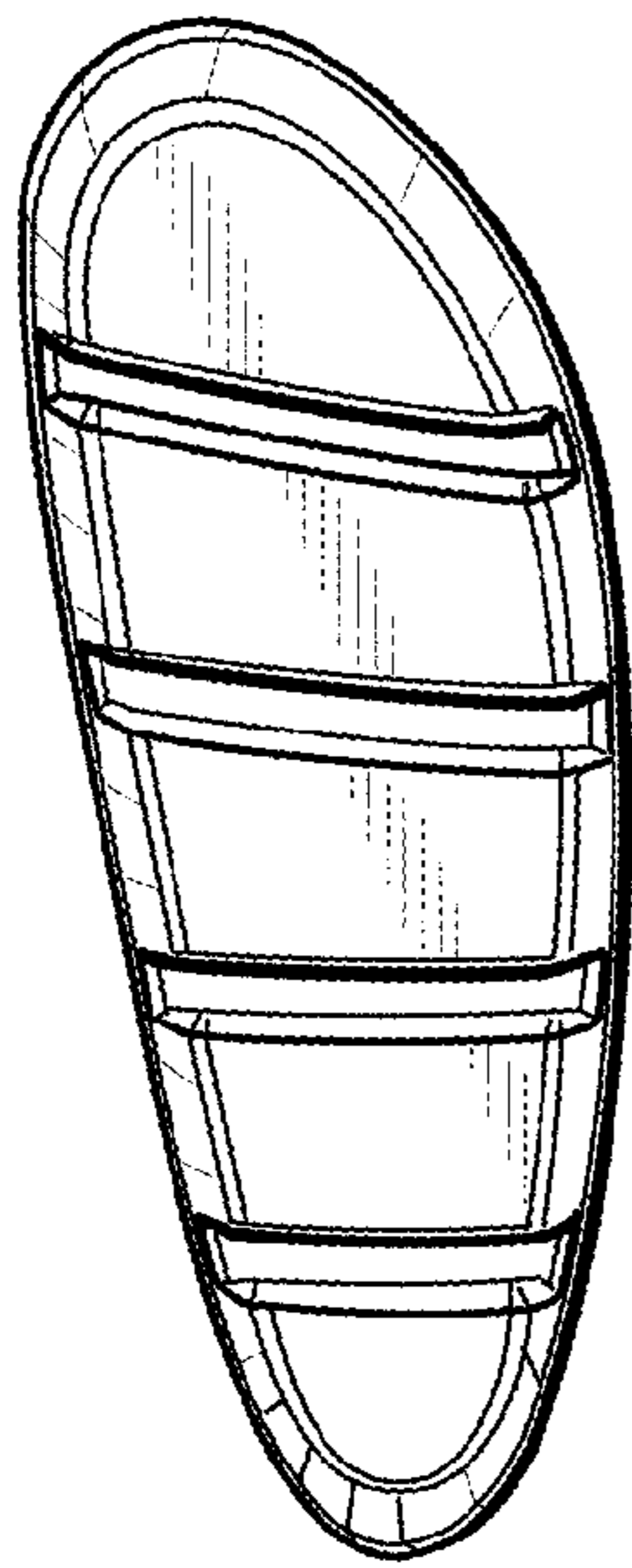

**FIG. 6**

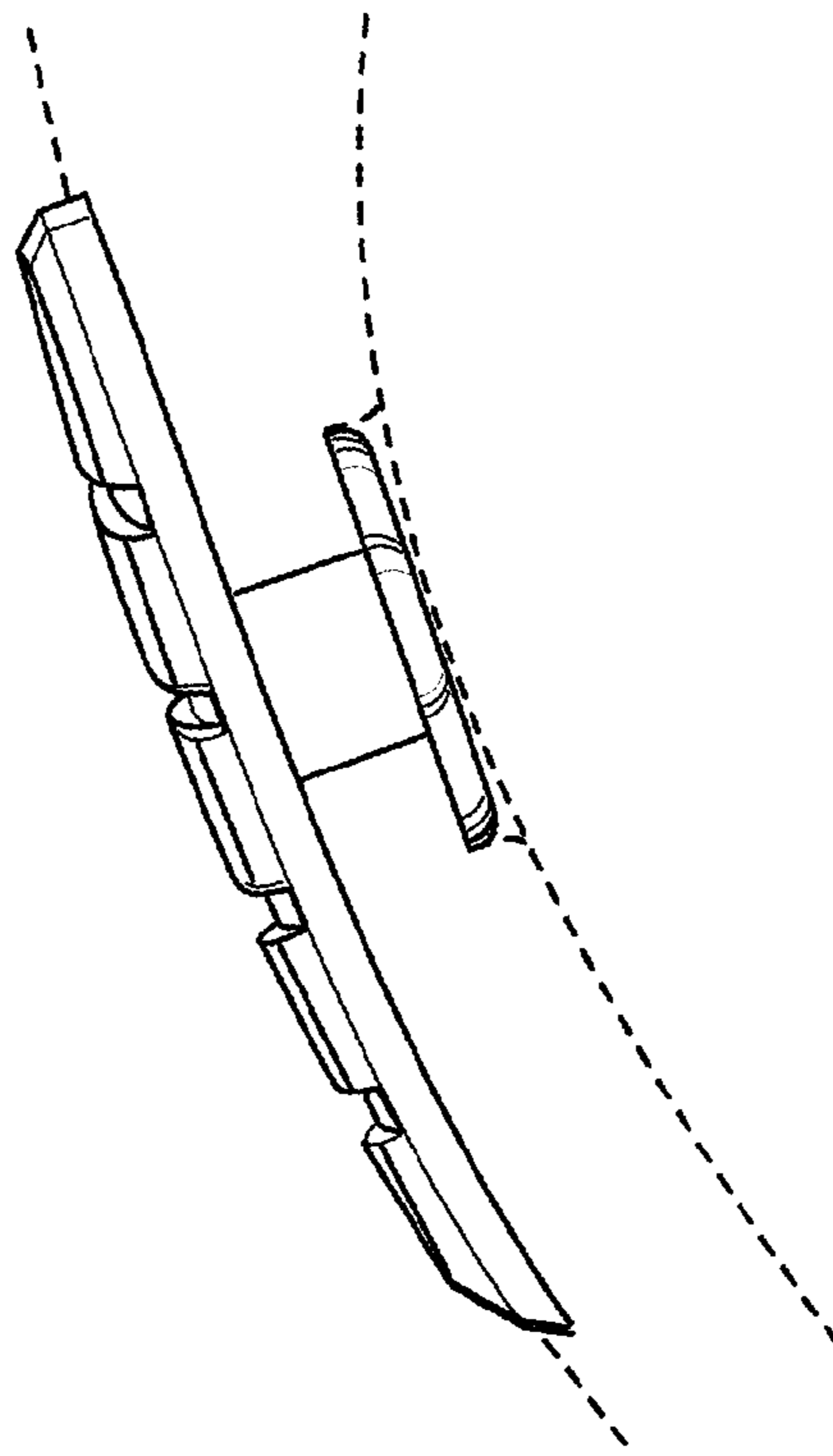

**FIG. 7**

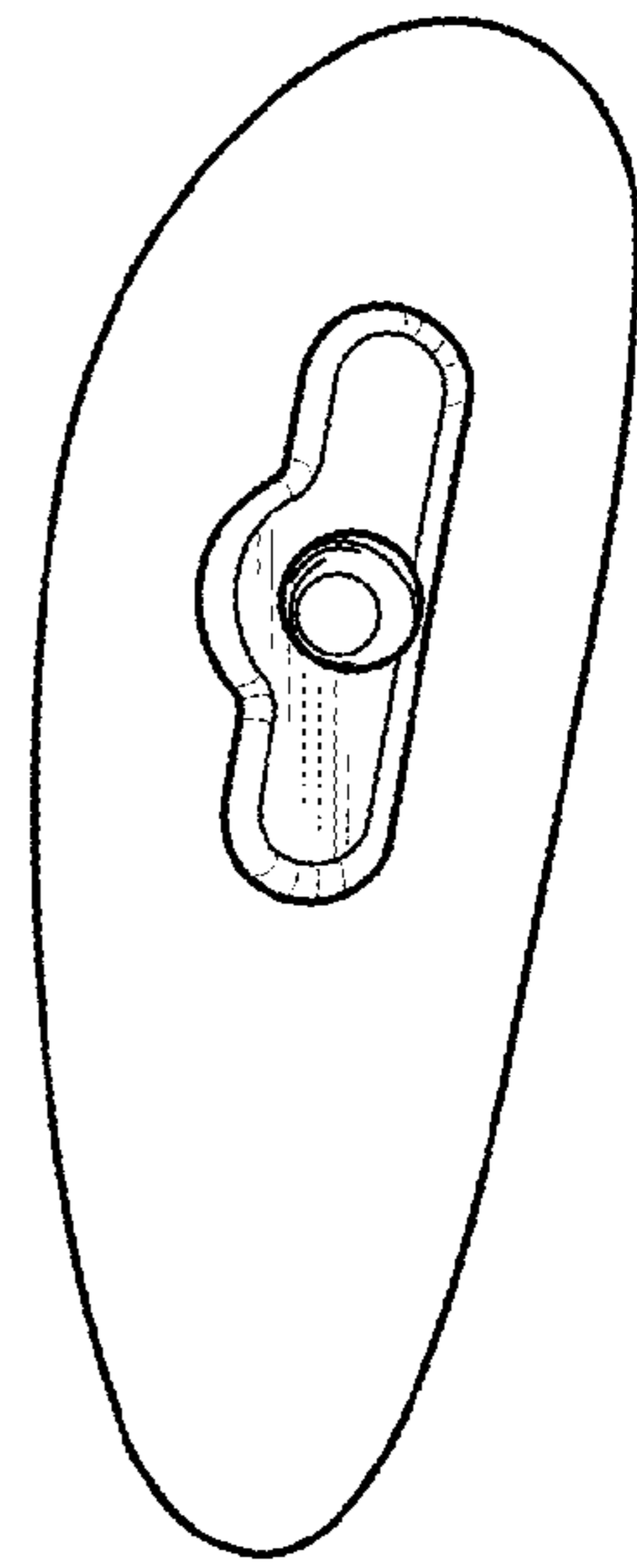

**FIG. 8**