



US00D912678S

(12) **United States Design Patent** (10) **Patent No.:** **US D912,678 S**
O'Donnell et al. (45) **Date of Patent:** **** Mar. 9, 2021**

(54) **BEZEL INSERT**

(71) Applicant: **Dell Products L.P.**, Round Rock, TX (US)

(72) Inventors: **Sean P. O'Donnell**, Brookline, MA (US); **Richard A. Crisp**, Austin, TX (US)

(73) Assignee: **Dell Products L.P.**, Round Rock, TX (US)

(**) Term: **15 Years**

(21) Appl. No.: **29/638,234**

(22) Filed: **Feb. 26, 2018**

(51) **LOC (13) Cl.** **14-02**

(52) **U.S. Cl.**
USPC **D14/445**

(58) **Field of Classification Search**
USPC D14/300-461; D5/1-4; D8/402;
D23/370; D10/128, 132
CPC G06F 1/181; G06F 1/182; H05K 7/1487;
H05K 7/18; H05K 9/0062; H05K 9/0081;
Y10T 428/1234; Y10T 428/12368
See application file for complete search history.

(56) **References Cited**

U.S. PATENT DOCUMENTS

1,335,613	A *	3/1920	Selle	F16B 35/041 411/368
3,228,309	A *	1/1966	Yevick	E04G 21/12 404/70
D224,208	S *	7/1972	Kuchar	D9/418
3,867,788	A *	2/1975	Mickelson	A47G 7/047 47/67
D268,962	S *	5/1983	Adams	D5/1
D347,834	S *	6/1994	Garmon	D14/446
5,681,189	A *	10/1997	Dunham	F16B 35/042 439/271
D402,436	S *	12/1998	Cawley	D1/129

(Continued)

OTHER PUBLICATIONS

EMC ScaleIO Node | posted at blog.dellemc.com Sep. 2015 [online].
© 2020 Dell Inc. [retrieved May 6, 2020] from Internet: <https://
blog.dellemc.com/en-us/introducing-emc-scaleio-node-loving-whats-
inside-the-box/> (Year: 2015).*

(Continued)

Primary Examiner — Katherine Glennon

(74) *Attorney, Agent, or Firm* — Zagorin Cave LLP;
Robert W. Holland

(57) **CLAIM**

We claim the ornamental design for a bezel insert, as shown and described.

DESCRIPTION

FIG. 1 is a front perspective view of the bezel insert comprising the present invention;
FIG. 2 is a front elevation view thereof;
FIG. 3 is a rear elevation view thereof;
FIG. 4 is a right side view thereof;
FIG. 5 is a left side view thereof;
FIG. 6 is a top view thereof;
FIG. 7 is a bottom view thereof;
FIG. 8 is a rear perspective view thereof;
FIG. 9 is a front perspective view thereof installed in a first example bezel;
FIG. 10 is a front perspective view thereof installed in a second example bezel; and,
FIG. 11 is a front perspective view thereof installed in a third example bezel.
Broken lines in FIGS. 1 and 3-8 show portions of the ornamental bezel insert that form no part of the claimed design. The broken lines in FIGS. 9-11 illustrate environmental structure only and form no part of the claimed design.

1 Claim, 9 Drawing Sheets

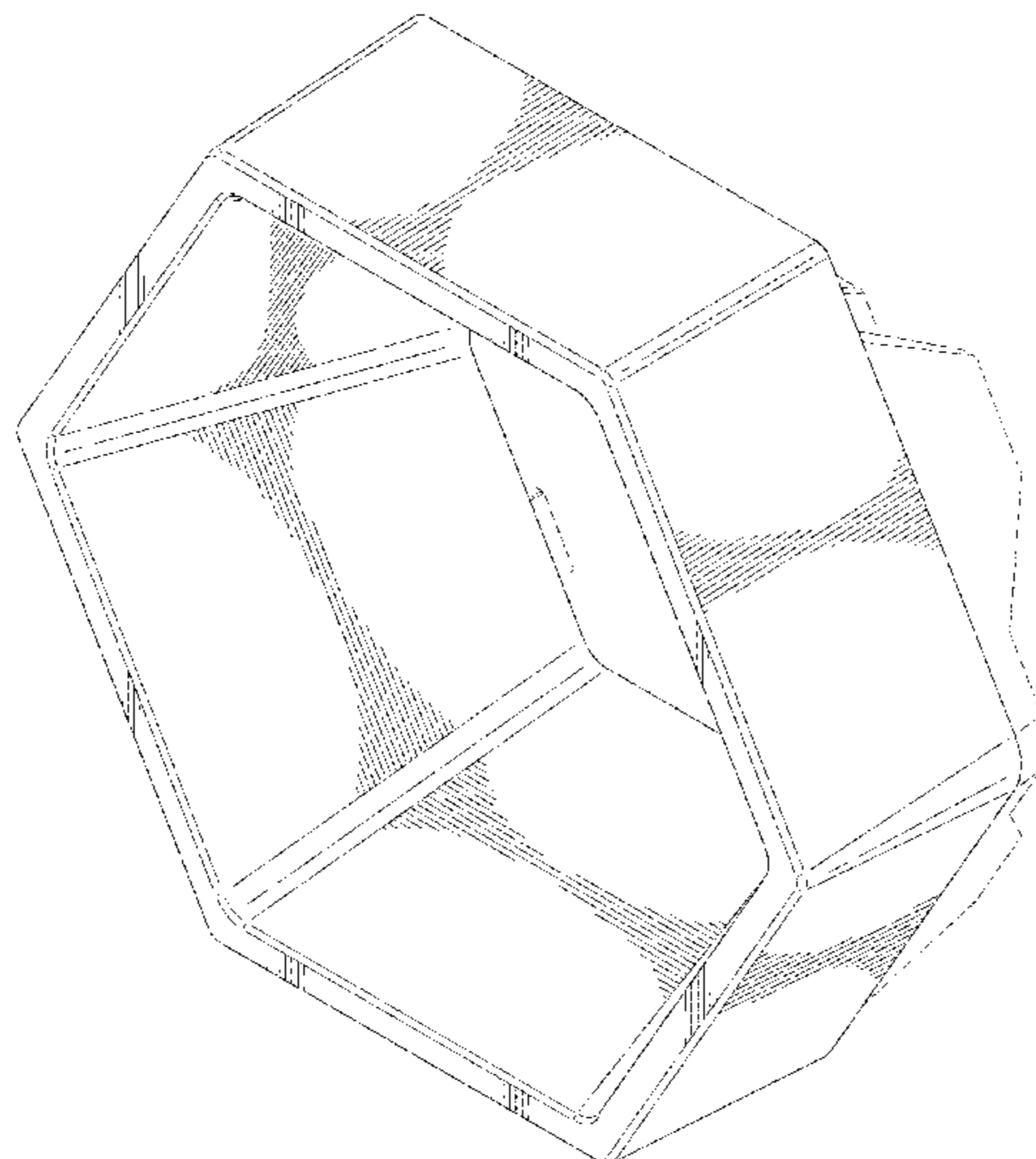

(56)

References Cited

U.S. PATENT DOCUMENTS

D432,868 S * 10/2000 Tan D7/584
 D464,357 S * 10/2002 Chien D14/444
 D534,369 S * 1/2007 Wright D6/678
 D615,450 S * 5/2010 Cherem D11/143
 D712,778 S * 9/2014 Kuiawa D11/40
 D729,549 S * 5/2015 Williams D6/675
 D739,713 S * 9/2015 Kelleghan D8/356
 D742,663 S * 11/2015 Williams D6/675
 D743,404 S * 11/2015 Ignomirello D14/432
 D759,227 S * 6/2016 Lofy D23/370
 D769,071 S * 10/2016 Heimsoth D7/509
 D786,258 S * 5/2017 Ignomirello D14/445
 D816,492 S * 5/2018 Reinhart D9/435
 D822,029 S * 7/2018 Crisp D14/445
 10,013,022 B1 * 7/2018 Aurongzeb G06F 1/1652
 D828,152 S * 9/2018 Huang D8/397
 D829,214 S * 9/2018 Baik D14/445
 10,303,907 B1 * 5/2019 Lauffer G06K 7/10544
 10,324,503 B1 * 6/2019 O'Donnell G06F 1/182
 D879,790 S * 3/2020 Donachy D14/444
 10,643,042 B2 * 5/2020 Lauffer G06K 19/06056
 2001/0015399 A1 * 8/2001 LaMotte G09F 15/0025
 248/165
 2012/0152908 A1 * 6/2012 Nagae B23H 9/00
 219/69.15
 2012/0205836 A1 * 8/2012 Chen B29C 45/4457
 264/328.1
 2012/0285738 A1 * 11/2012 Cochrane H05K 9/0041
 174/382
 2015/0201723 A1 * 7/2015 Rayner A45C 13/008
 224/191

OTHER PUBLICATIONS

Terra Cotta 3D Garden Pot Tutorial | posted at needlesnknowledge.blogspot.com Jun. 2013 [online]. [retrieved May 7, 2020] from Internet: <<http://needlesnknowledge.blogspot.com/2013/06/terra-cotta-3d-garden-pot-tutorial.html>> (Year: 2013).*

Dell EMC ScaleIO.Next Announced | posted at storagereview.com May 2017 [online]. © 1998-2020 Flying Pig Ventures, LLC [retrieved May 5, 2020] from Internet: <<https://www.storagereview.com/news/dell-emc-scaleio-next-announced>> (Year: 2017).*

Hierarchical honeycombs Engineering University of Exeter | posted at emps.exeter.ac.uk; page capture date Jul. 10, 2013 [online]. © University of Exeter [retrieved May 7, 2020] from Internet: <<http://emps.exeter.ac.uk/engineering/research/materials-manufacturing/interests/multi-func/honeycombs/>> (Year: 2013).*

Francois Huber comb building illustration | posted at beeculture.com Jan. 2019; illustration circa 1821 [online]. © Bee Culture [retrieved May 6, 2020] from Internet: <<https://www.beeculture.com/honeycomb/>> (Year: 1821).*

Dell EMC Infrastructure iF World Design Guide | ifworlddesignguide.com; no date; published 2018 [online]. © 2020 iF Design [retrieved Nov. 10, 2020] from Internet: <<https://ifworlddesignguide.com/entry/236105-dell-emc-infrastructure>> (Year: 2018).*

* cited by examiner

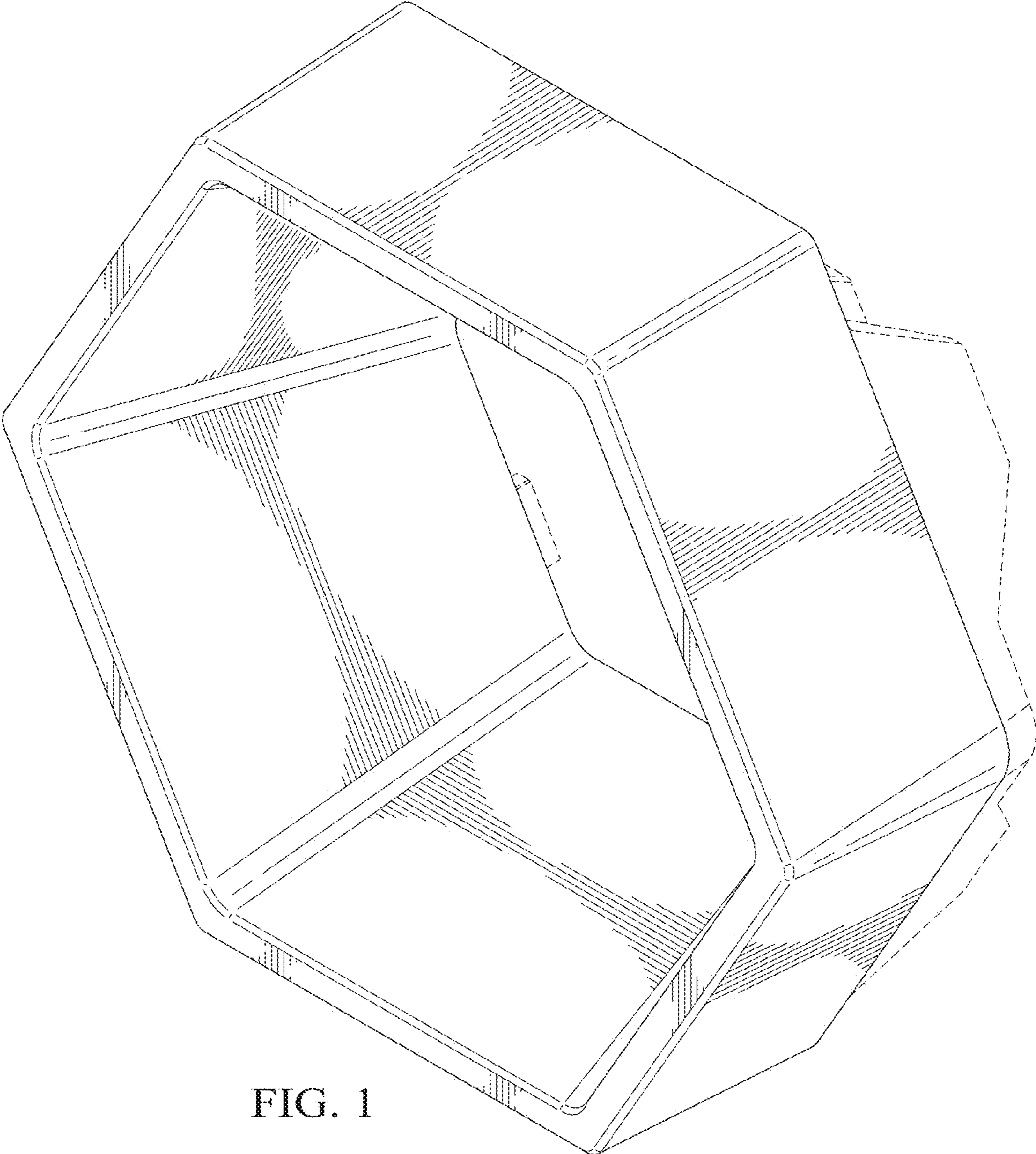

FIG. 1

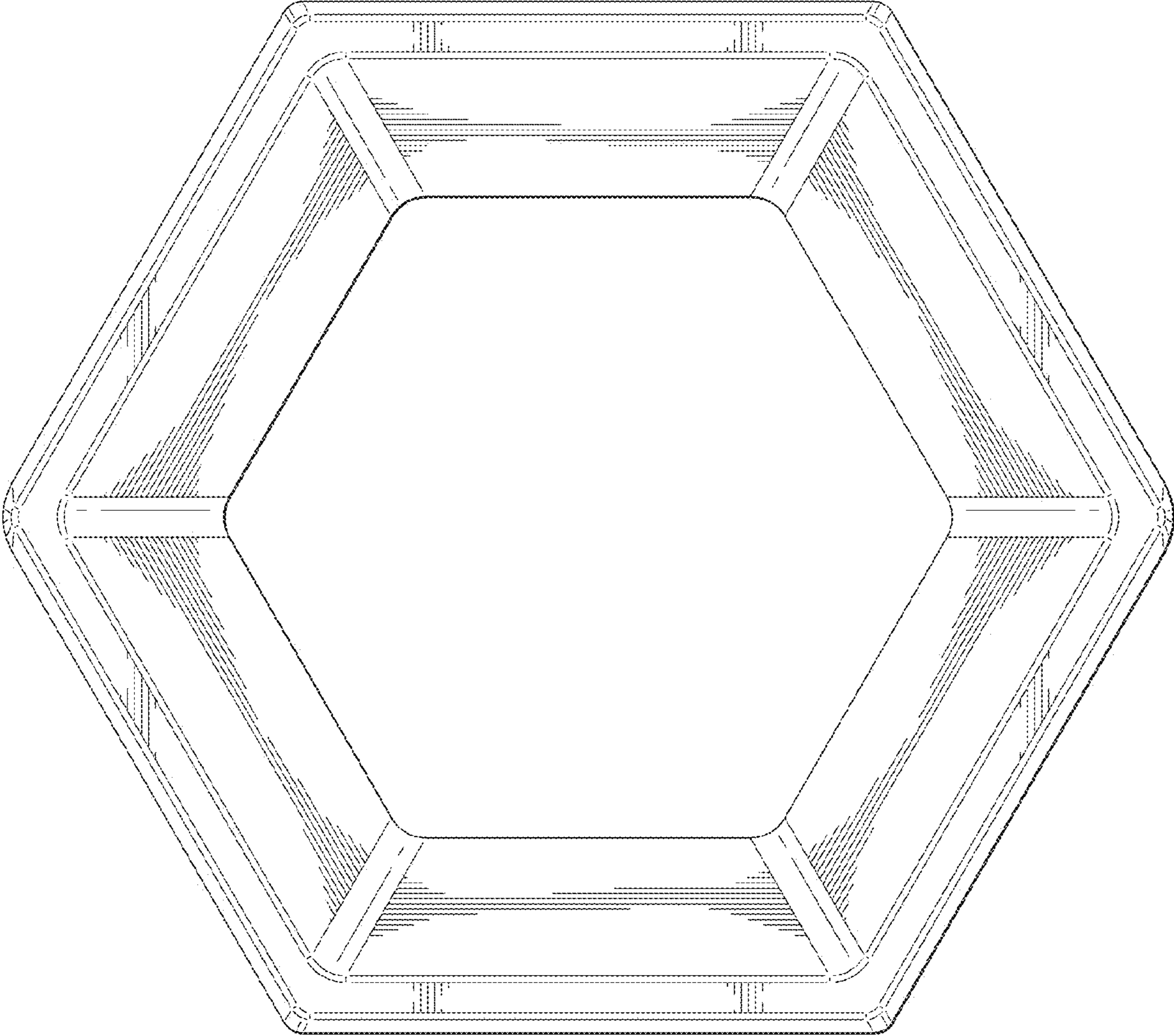

FIG. 2

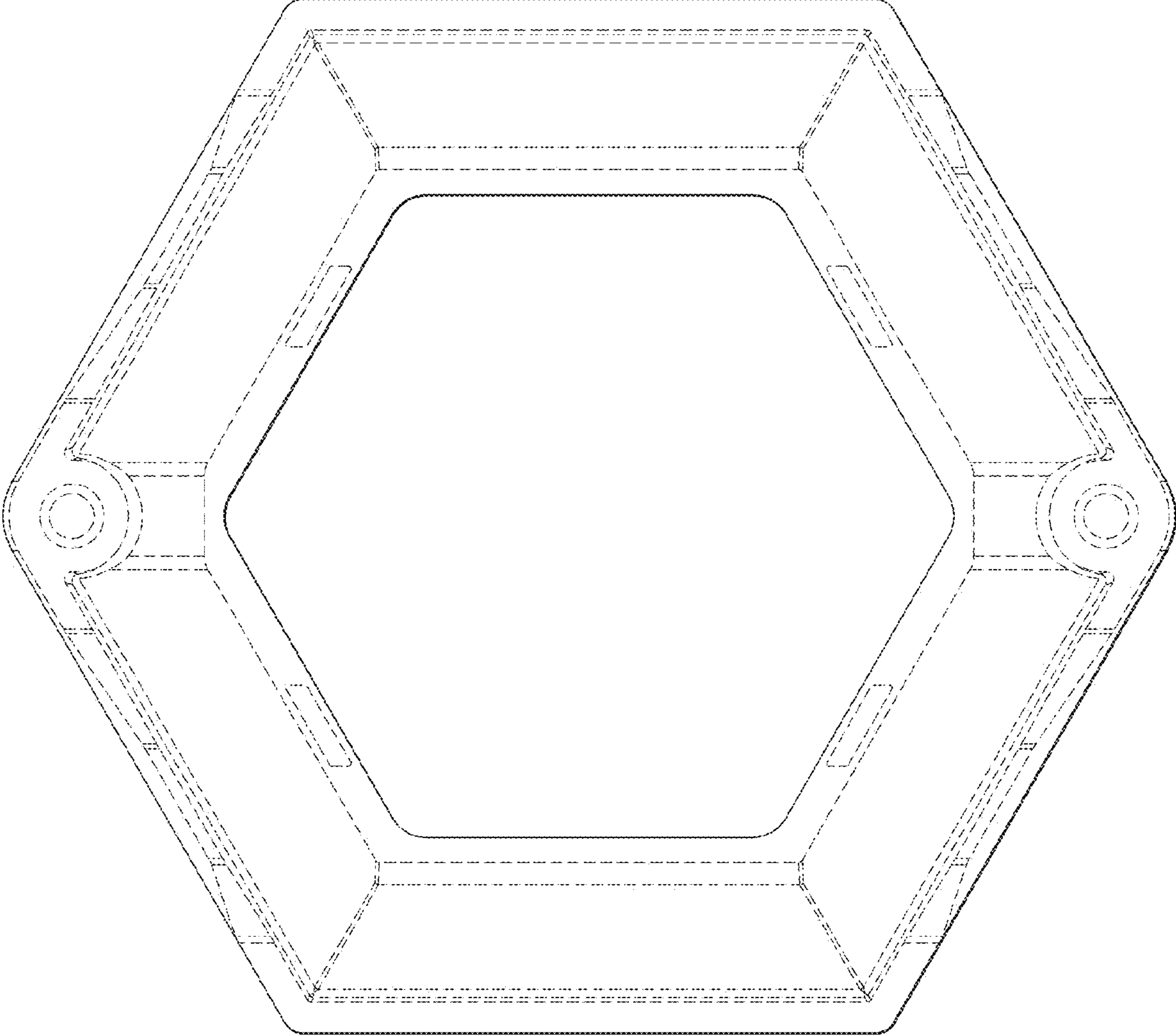

FIG. 3

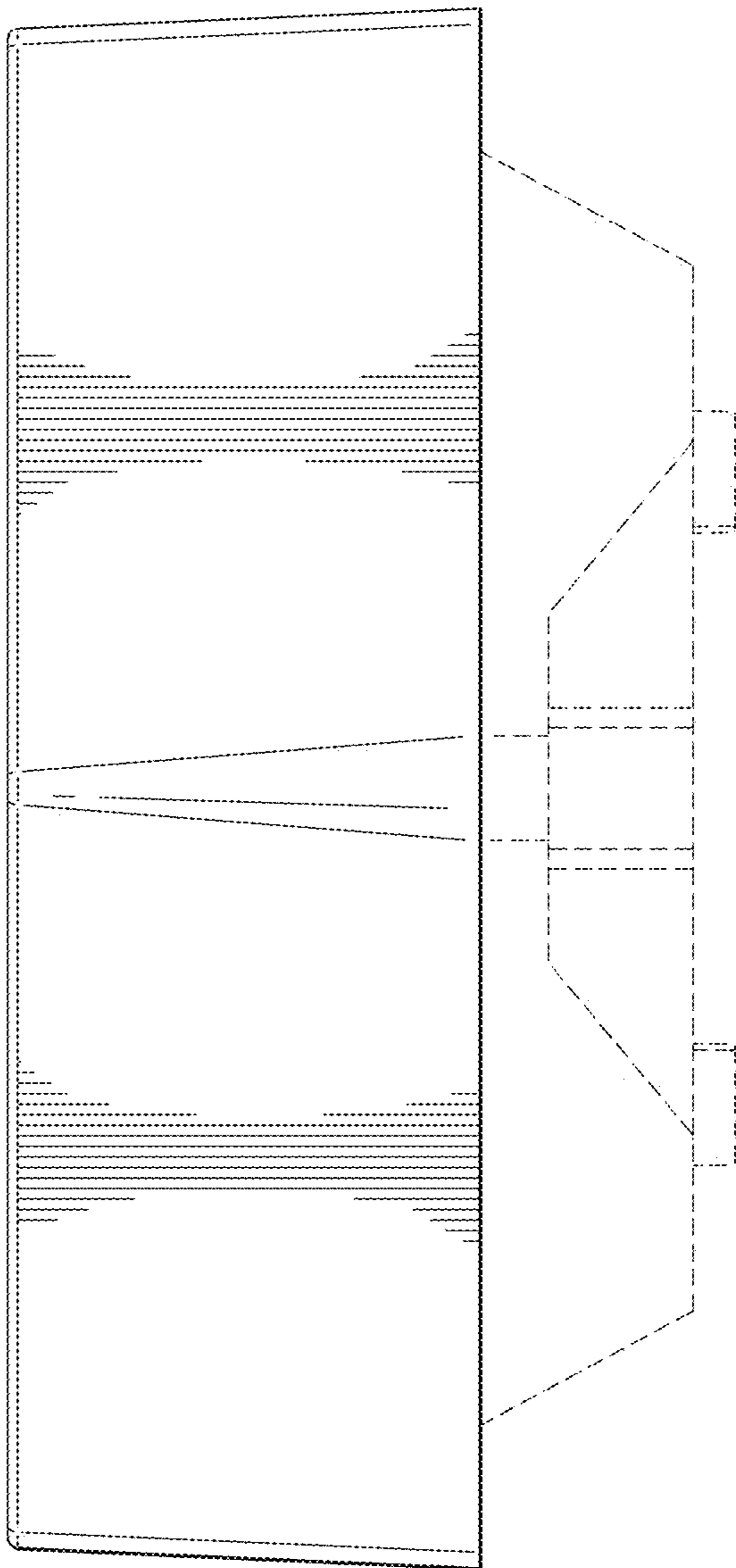

FIG. 4

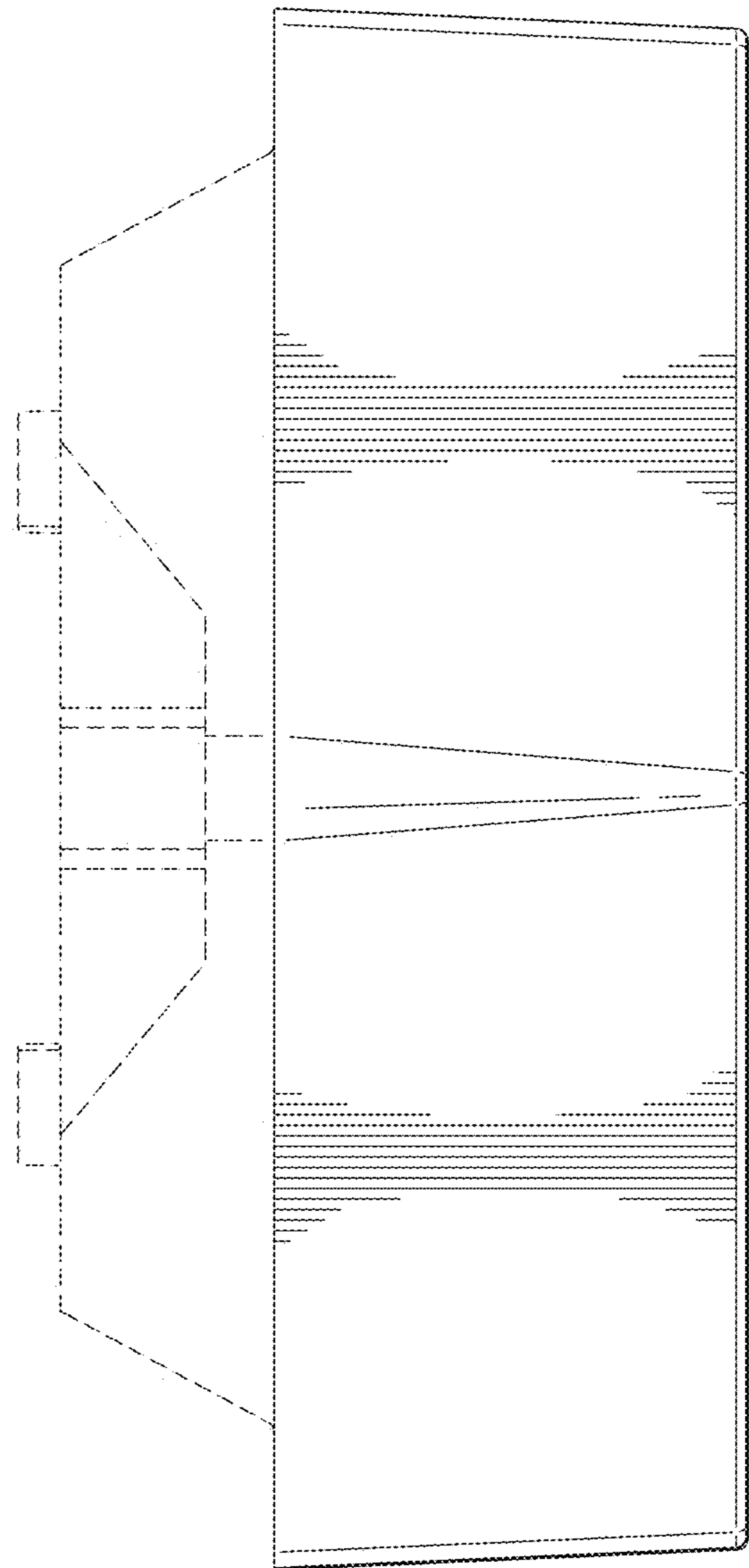

FIG. 5

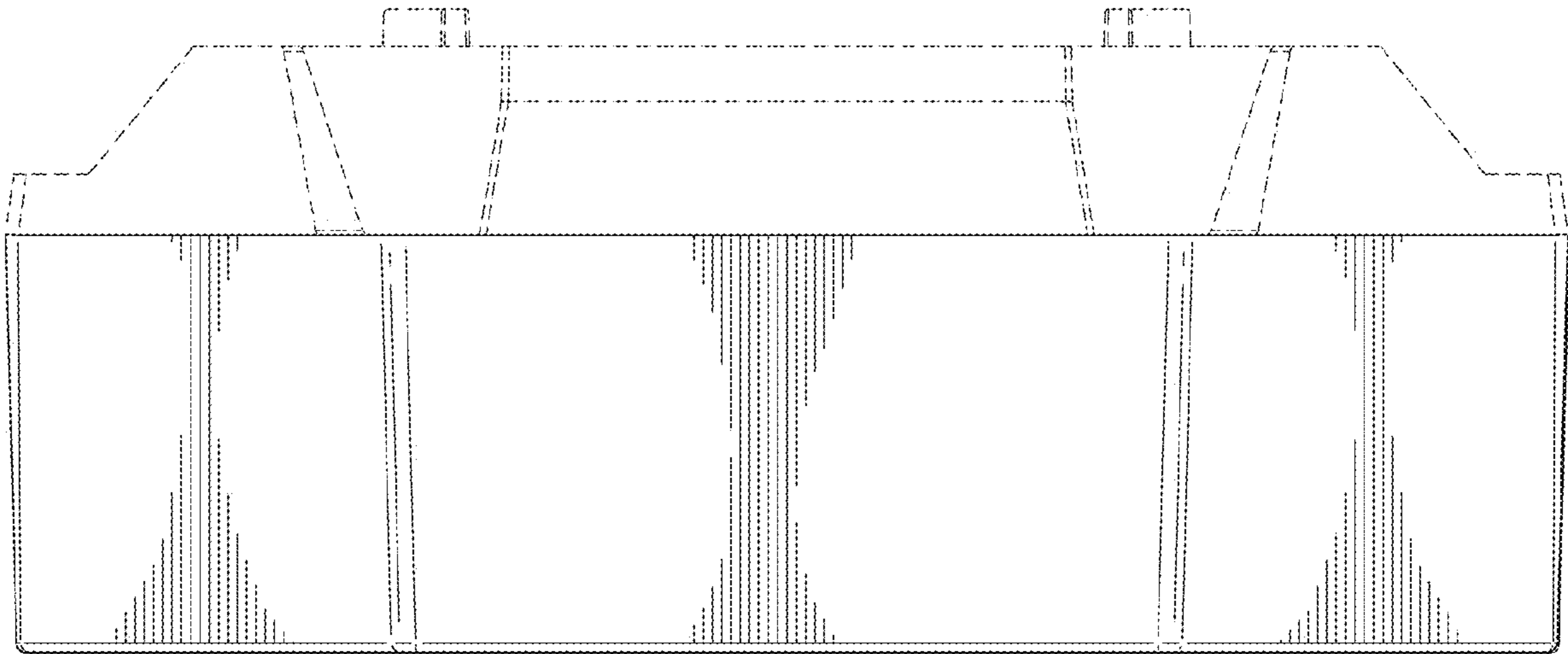

FIG. 6

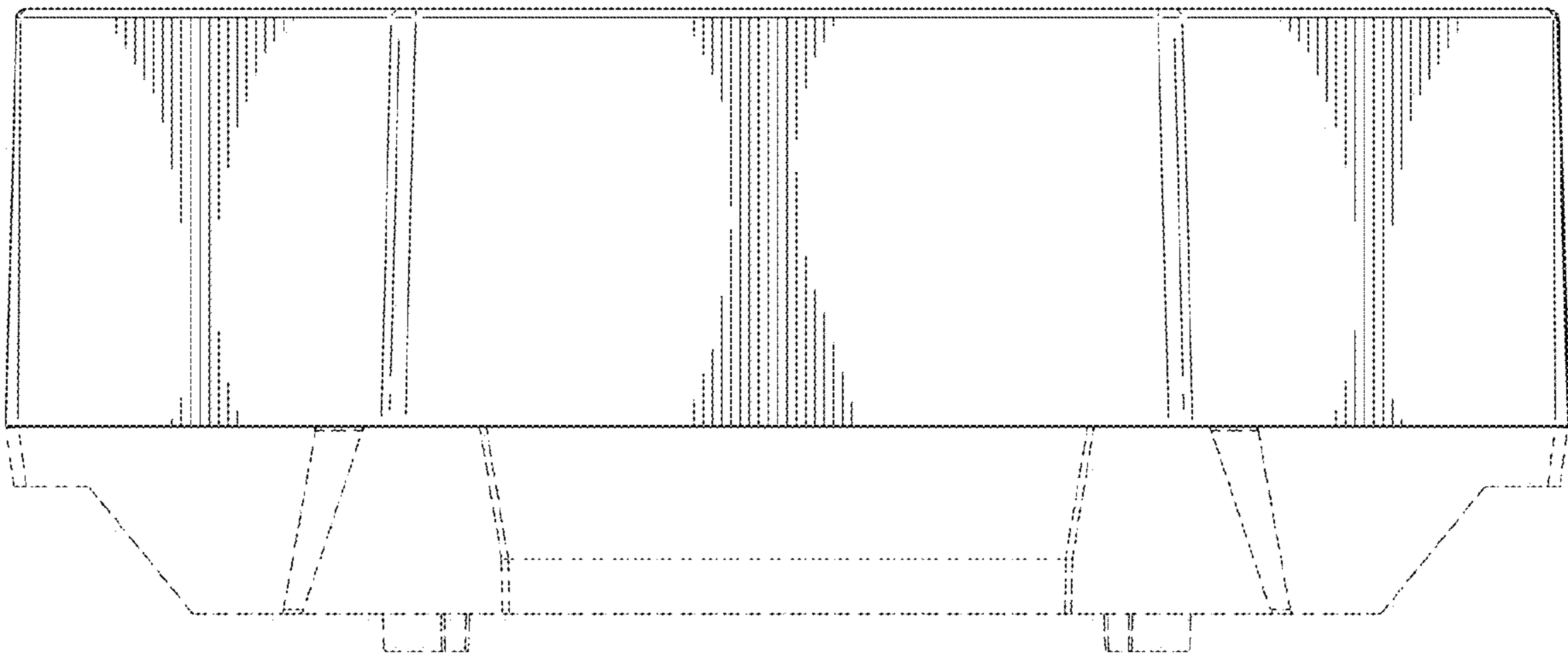

FIG. 7

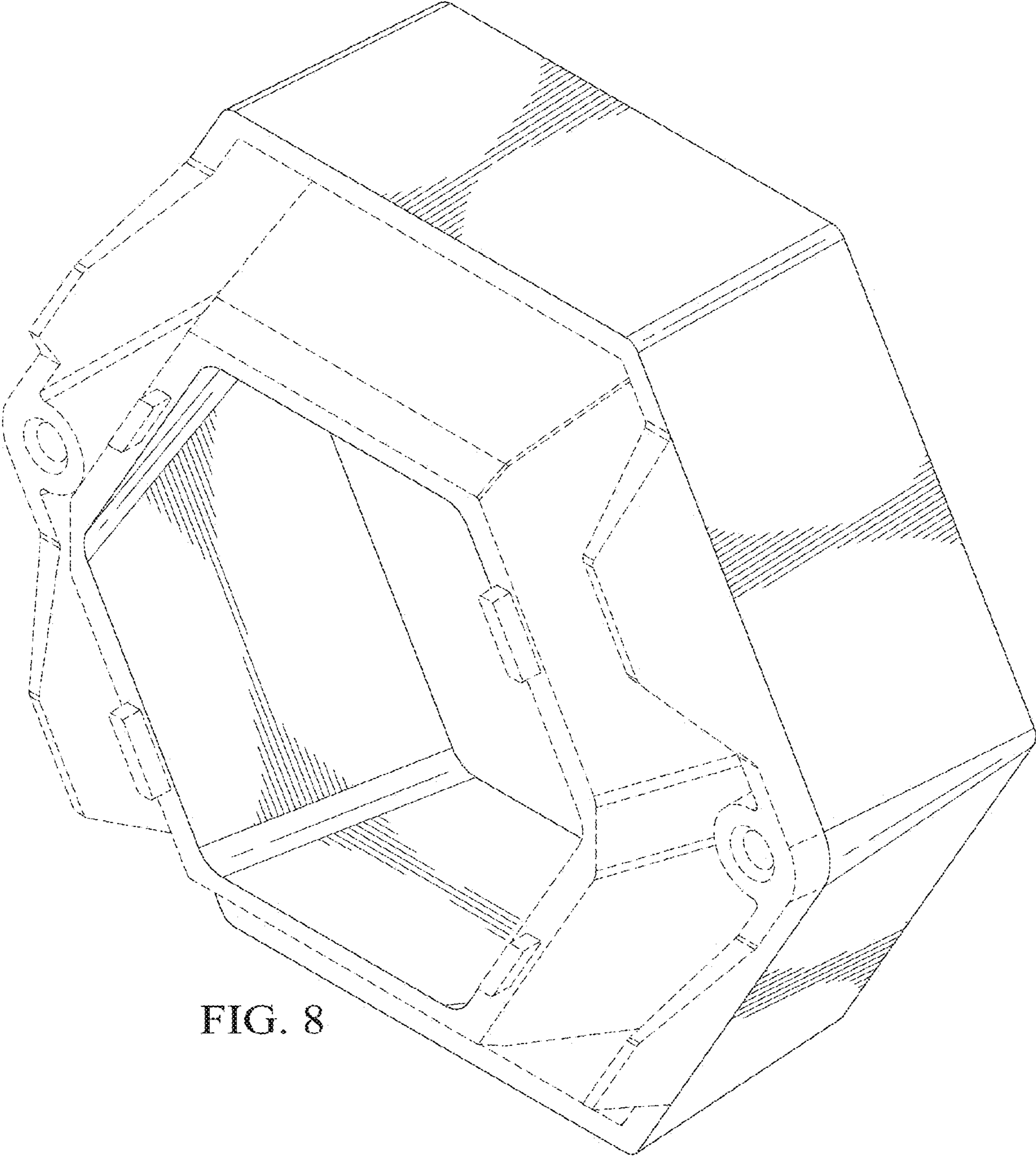

FIG. 8

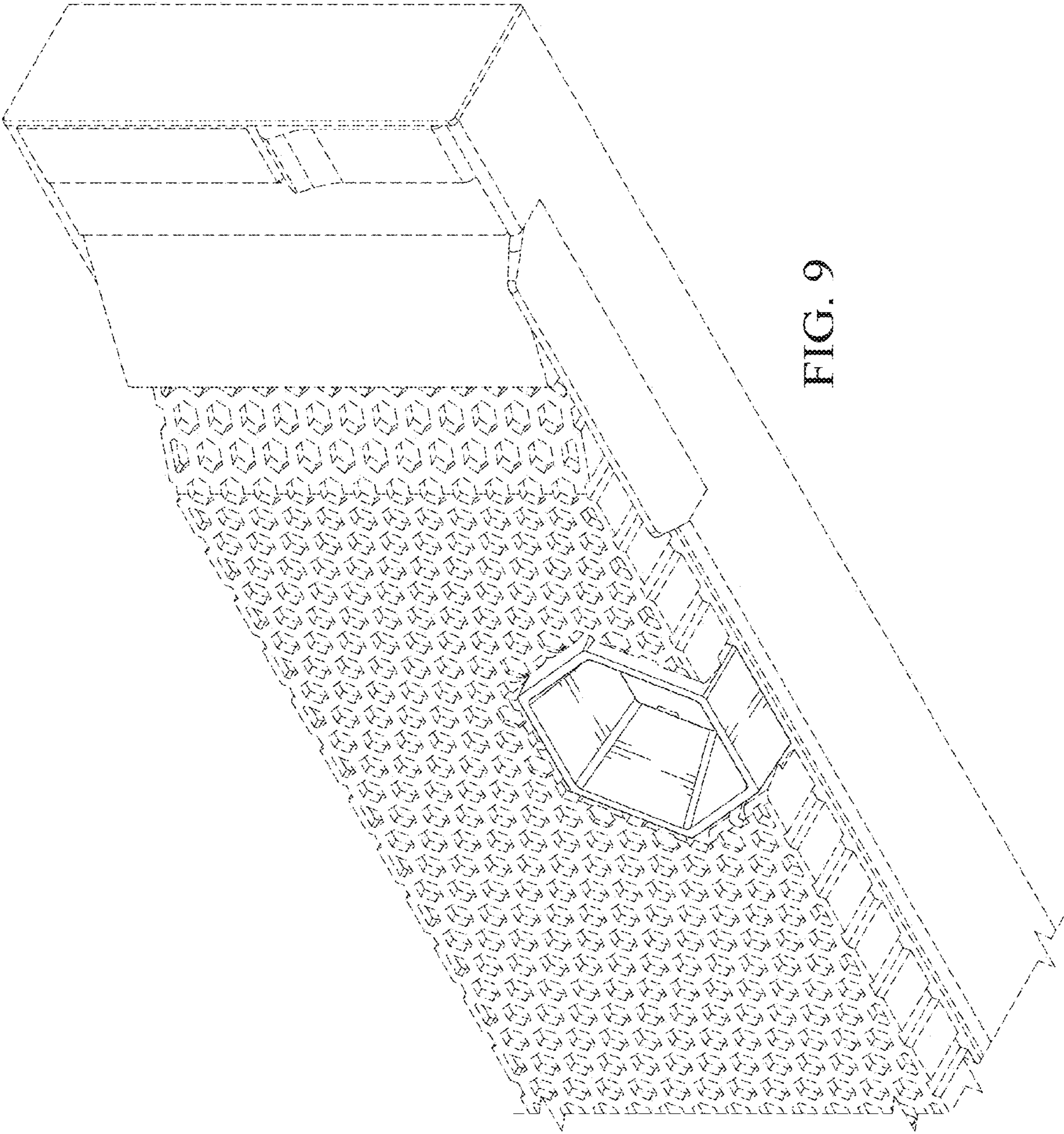

FIG. 9

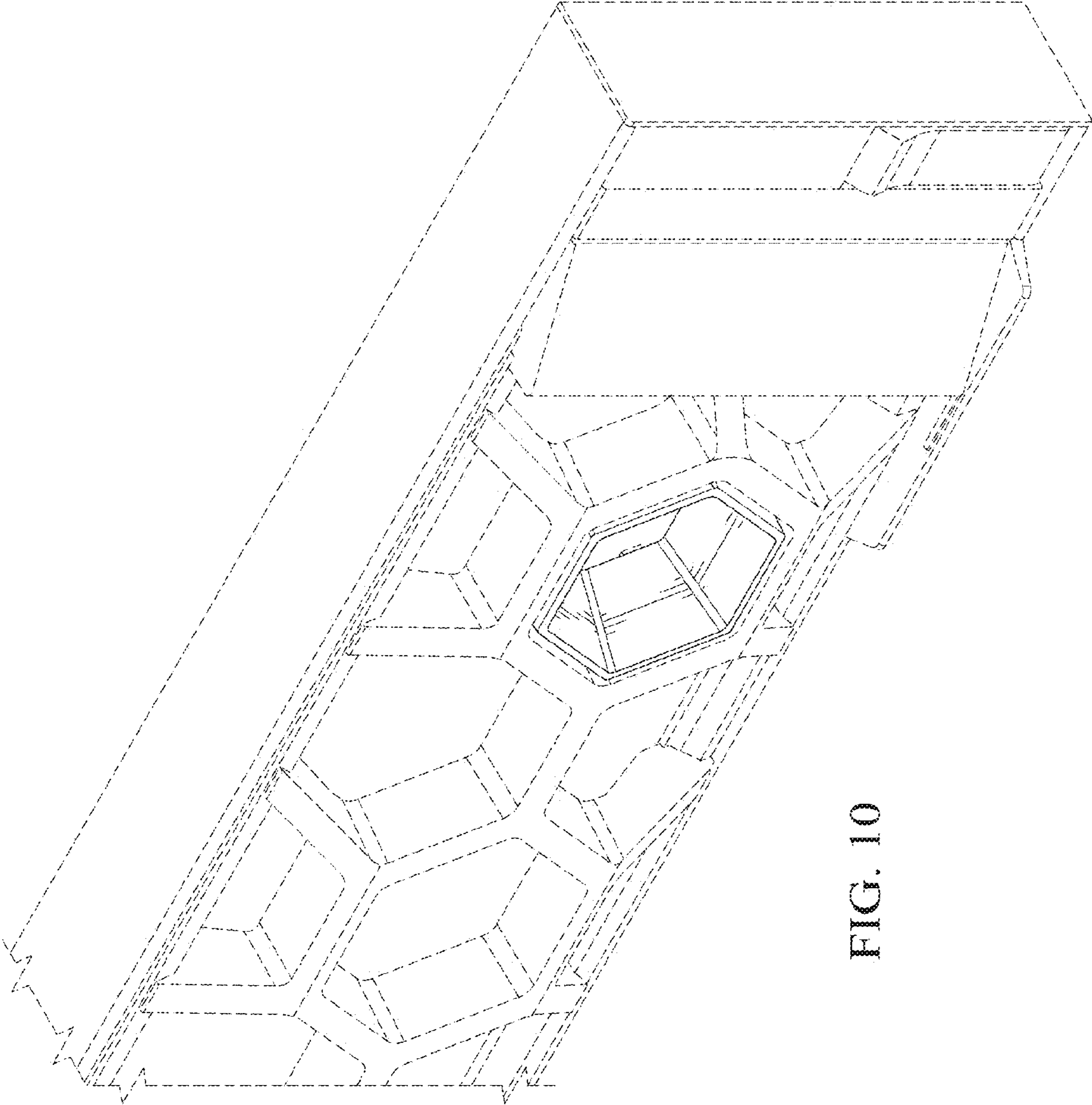

FIG. 10

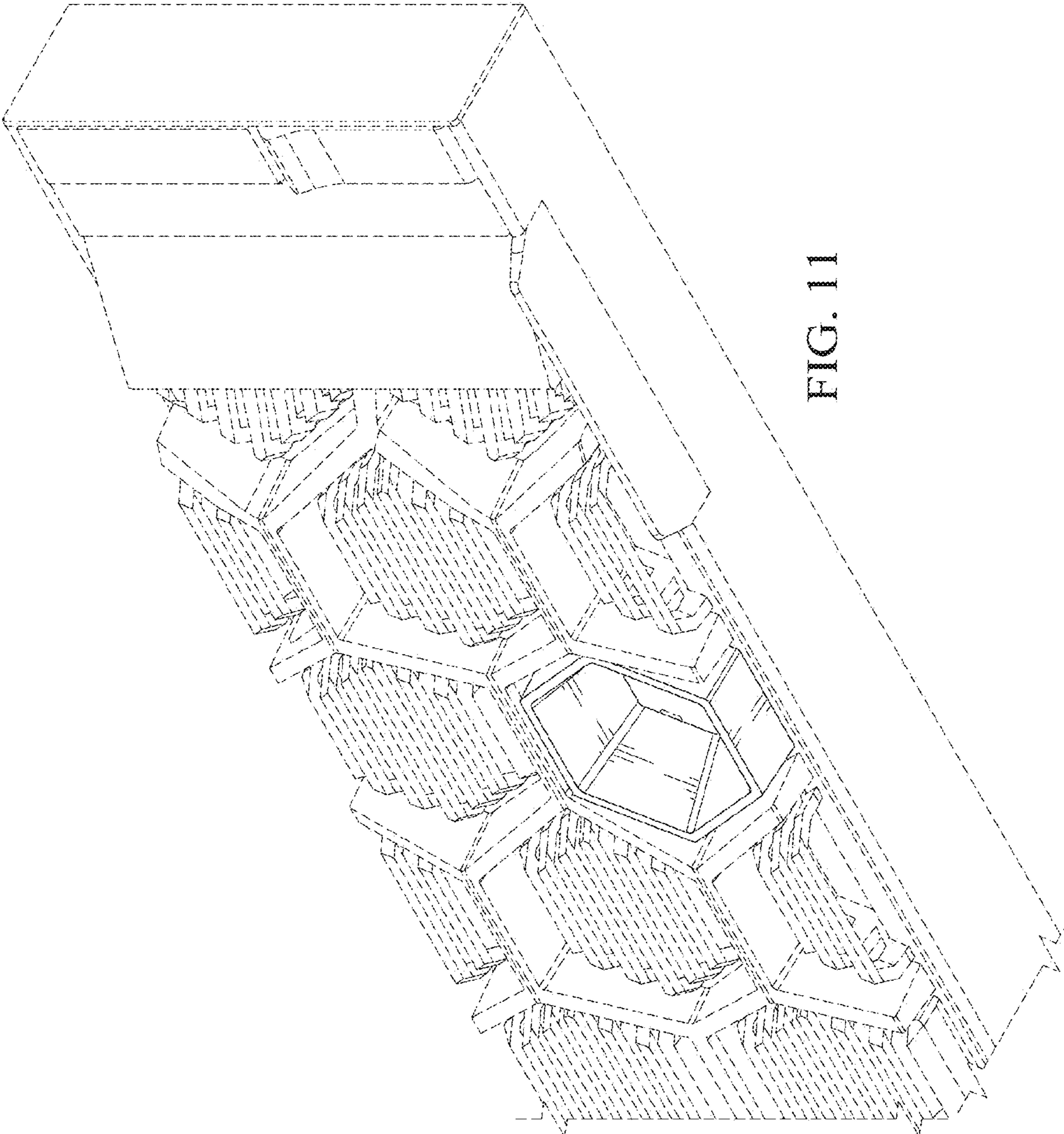

FIG. 11