



US00D912571S

(12) **United States Design Patent** (10) **Patent No.:** **US D912,571 S**
van Zanten et al. (45) **Date of Patent:** **** Mar. 9, 2021**

(54) **NURSERY POT**

- (71) Applicant: **PAN AMERICAN NURSERY PRODUCTS INC., Surrey (CA)**
- (72) Inventors: **Edward van Zanten, White Rock (CA); Ian van Zanten, Langley (CA)**
- (73) Assignee: **PAN AMERICAN NURSERY PRODUCTS INC., Surrey (CA)**
- (**) Term: **15 Years**
- (21) Appl. No.: **29/697,182**
- (22) Filed: **Jul. 4, 2019**
- (51) **LOC (13) Cl.** **11-02**
- (52) **U.S. Cl.**
USPC **D11/155**
- (58) **Field of Classification Search**
USPC D11/143–156, 164; D3/304, 313, 314; D6/403, 404, 405, 556, 557, 558; D7/357, 553.2, 553.3, 554.3, 554.4; D9/433, 454, 455
CPC . A01G 5/04; A01G 9/02; A01G 9/021; A01G 9/022; A01G 9/027; A01G 9/028; A01G 9/029; A01G 9/0293; A01G 9/0295; A01G 9/0297; A01G 9/0299; A01G 9/04; A01G 9/042; A01G 9/045; A47G 7/00; A47G 7/02; A47G 7/04; A47G 7/06; A47G 7/08
See application file for complete search history.

(56) **References Cited**

U.S. PATENT DOCUMENTS

- D19,406 S * 11/1889 Whilldin D11/153
- 1,627,282 A * 5/1927 Gran B65F 1/02
220/4.33
- D241,407 S * 9/1976 Johnson D34/1
- D338,758 S * 8/1993 Sexton D34/1

(Continued)

OTHER PUBLICATIONS

Photograph of a nursery pot sold by Pan American Nursery Products Inc. since at least as early as 2016, including lid portion thereof.
(Continued)

Primary Examiner — Elizabeth A. Albert
(74) *Attorney, Agent, or Firm* — Oyen Wiggs Green & Mutala LLP

(57) **CLAIM**

The ornamental design for a nursery pot, as shown and described.

DESCRIPTION

FIG. 1 is a perspective view of a nursery pot wherein a lid and a body of the nursery pot are in an assembled configuration;

FIG. 2 is a top view thereof;

FIG. 3 is a bottom view thereof;

FIG. 4 is a front view thereof;

FIG. 5 is a rear view thereof;

FIG. 6 is a left side view thereof;

FIG. 7 is a right side view thereof;

FIG. 8 is an exploded view thereof showing the lid separated from the body;

FIG. 9 is a side view of the body alone shown without the lid for convenience;

FIG. 10 is a bottom view thereof;

FIG. 11 is a top view thereof;

FIG. 12 is a perspective view thereof;

FIG. 13 is a cross-sectional view thereof taken along the plane 13-13 in FIG. 12;

FIG. 14 is a top view of the lid shown without the body for convenience;

FIG. 15 is a bottom perspective view thereof;

FIG. 16 is a top perspective view thereof;

FIG. 17 is a bottom view thereof; and,

FIG. 18 is a side view thereof.

1 Claim, 17 Drawing Sheets

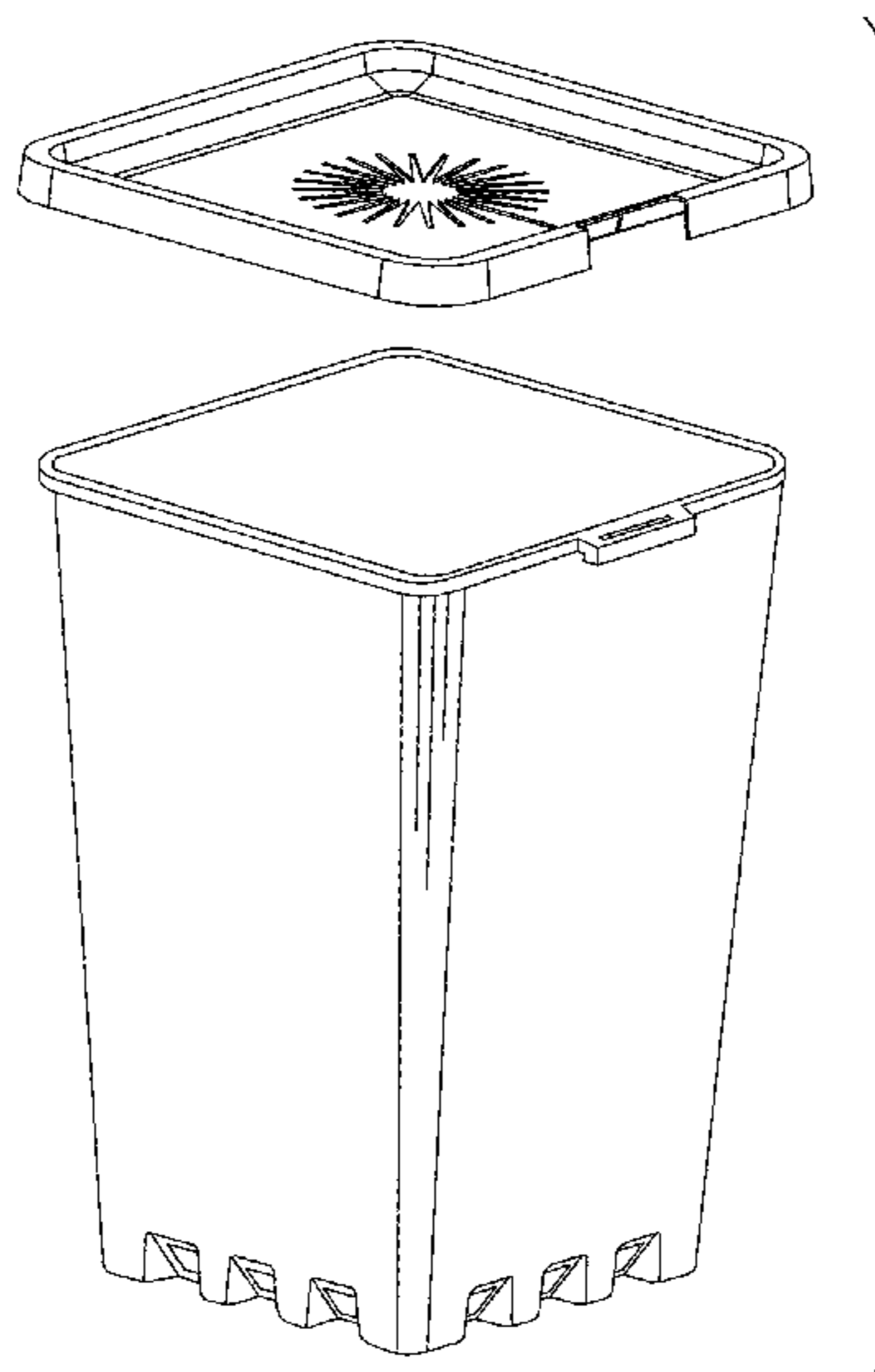

(56)

References Cited

U.S. PATENT DOCUMENTS

D480,326	S *	10/2003	Carlson	D11/155
D625,649	S *	10/2010	Rooney	D11/146
D635,052	S *	3/2011	Rooney	D11/146
D639,704	S *	6/2011	Harshman	D11/146
D653,162	S *	1/2012	Moore	D11/155
8,146,766	B2 *	4/2012	Vovan	B65D 81/3205 220/260
9,027,277	B2 *	5/2015	Castleberry	B65D 85/505 47/41.01
9,044,109	B2 *	6/2015	De Pagter	A47G 7/07
9,185,853	B1 *	11/2015	Ascherman	A01G 9/02
D819,831	S *	6/2018	Franzke	D25/16
D870,593	S *	12/2019	Keeble	D11/155
D875,598	S *	2/2020	Pettigrew	D11/143
D875,599	S *	2/2020	Keeble	D11/155
10,602,672	B2 *	3/2020	Kolar	A01G 9/029
D885,175	S *	5/2020	Schneider	D9/414
D885,969	S *	6/2020	Zhang	D11/155
10,687,479	B2 *	6/2020	Holby	A01G 9/029
10,701,867	B2 *	7/2020	Quinlan	A01G 9/02
2006/0112624	A1 *	6/2006	Bortman	A47G 7/07 47/41.12
2013/0036669	A1 *	2/2013	Rabii	A01G 31/02 47/62 R

OTHER PUBLICATIONS

Rendered drawings of a nursery pot sold by Pan American Nursery Products Inc. since at least as early as 2016.

* cited by examiner

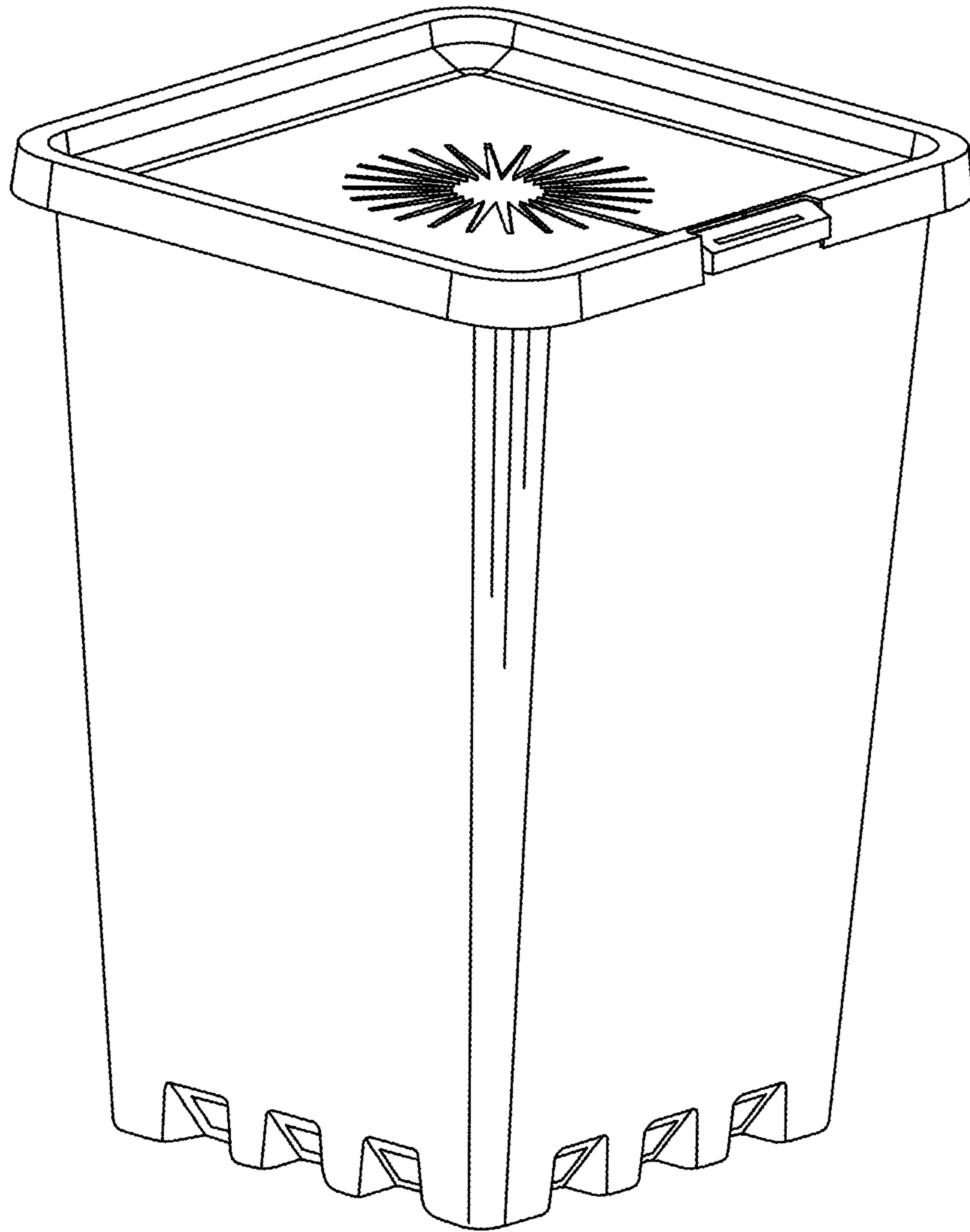

FIG. 1

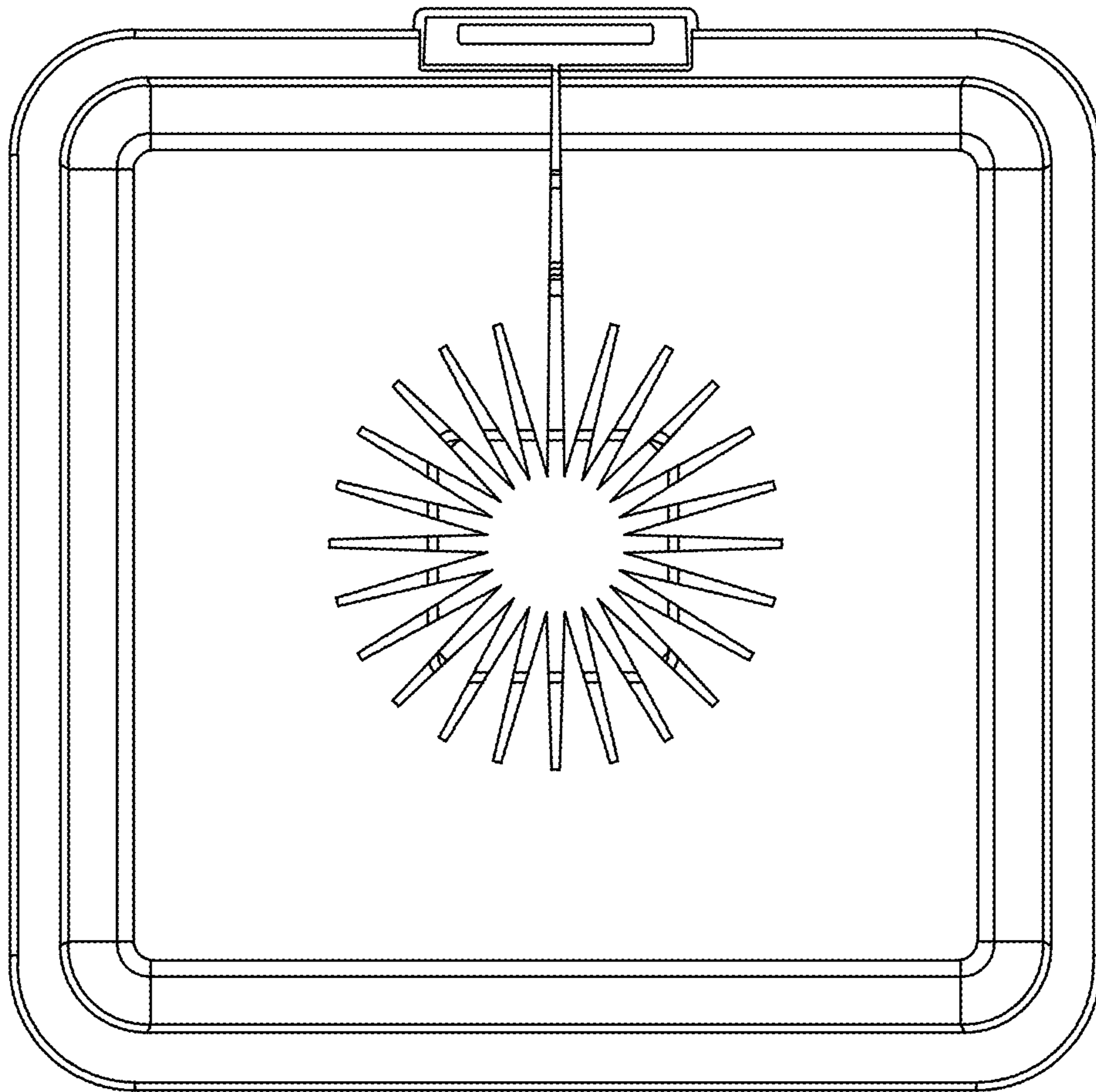

FIG. 2

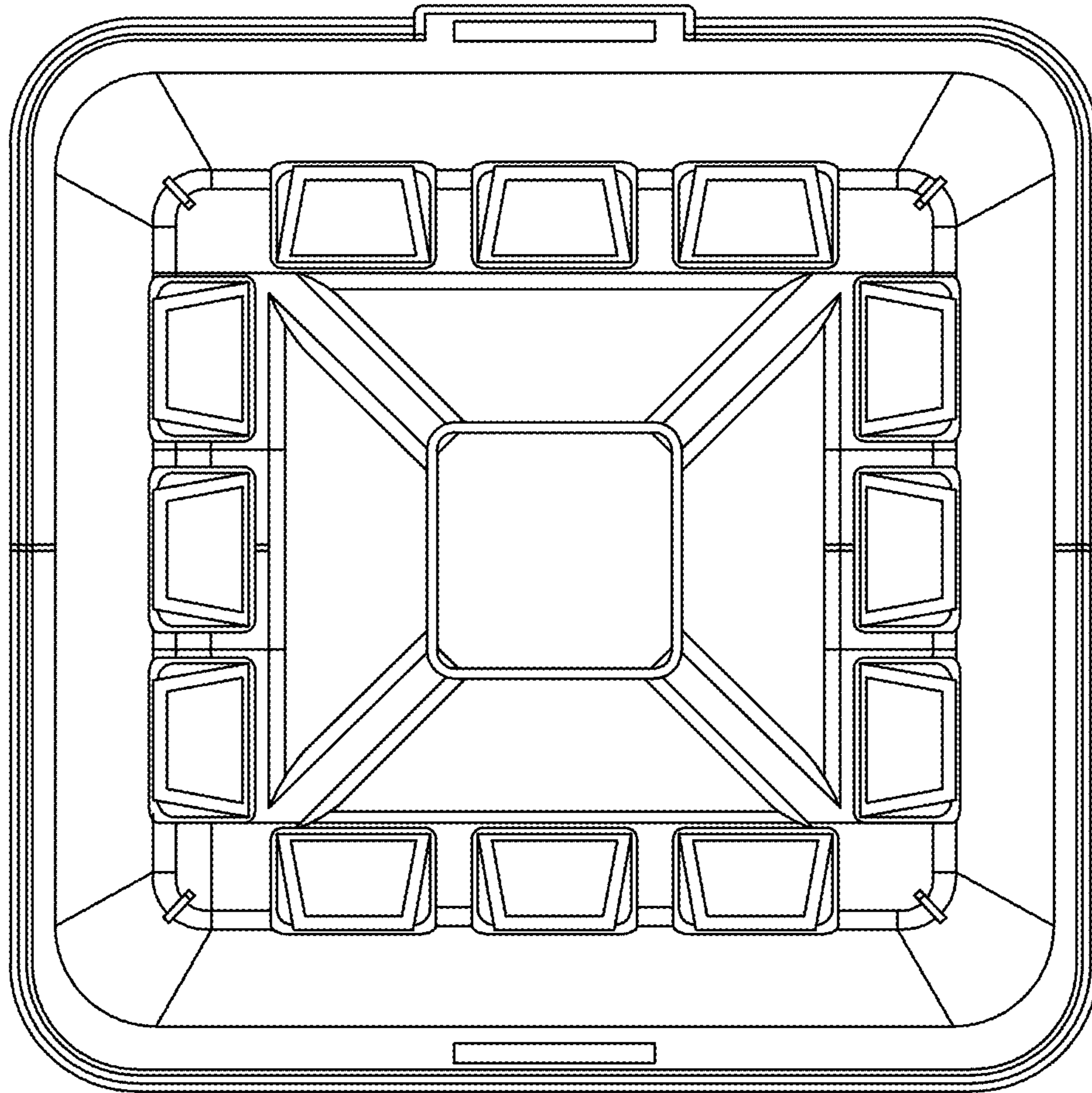

FIG. 3

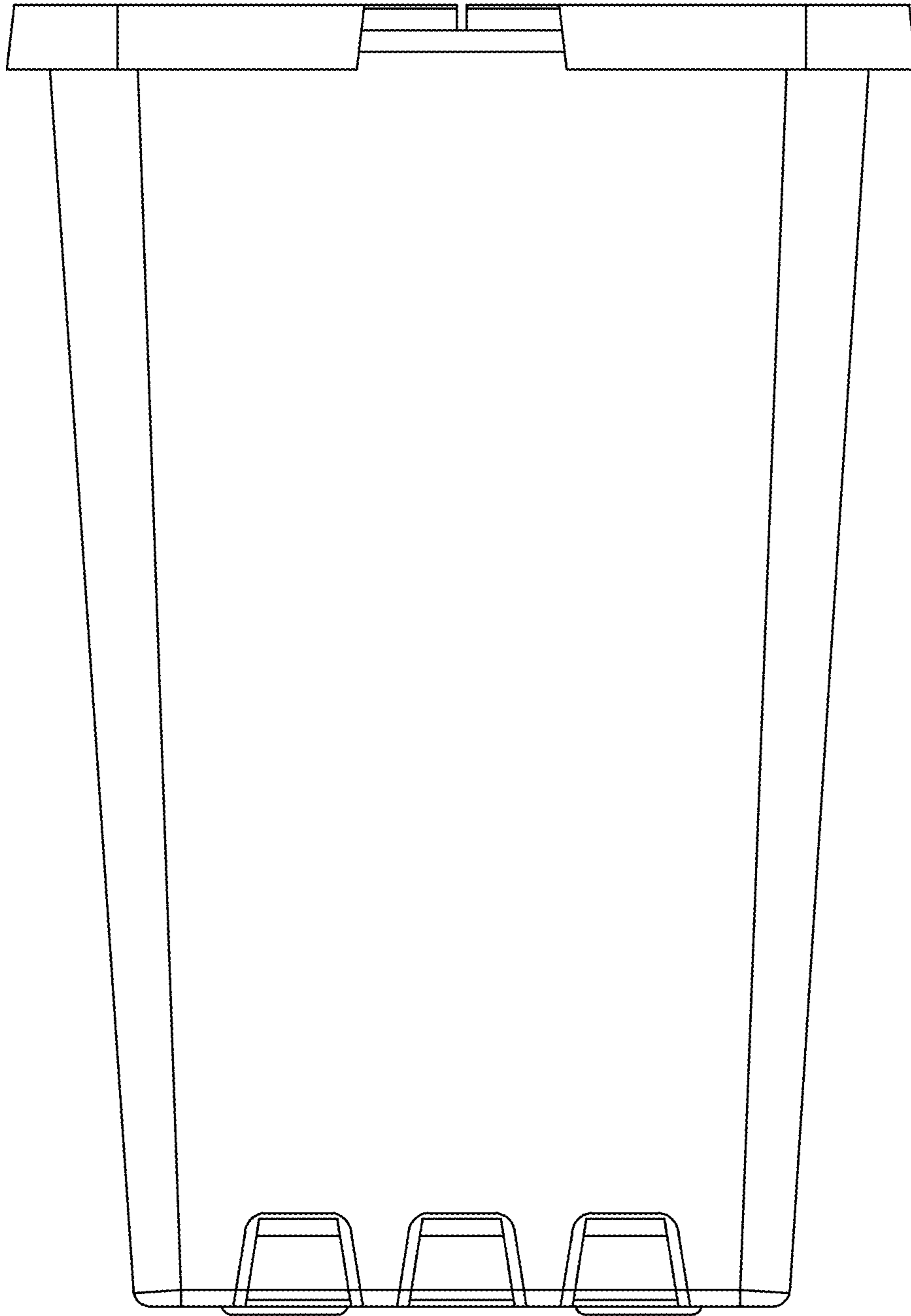

FIG. 4

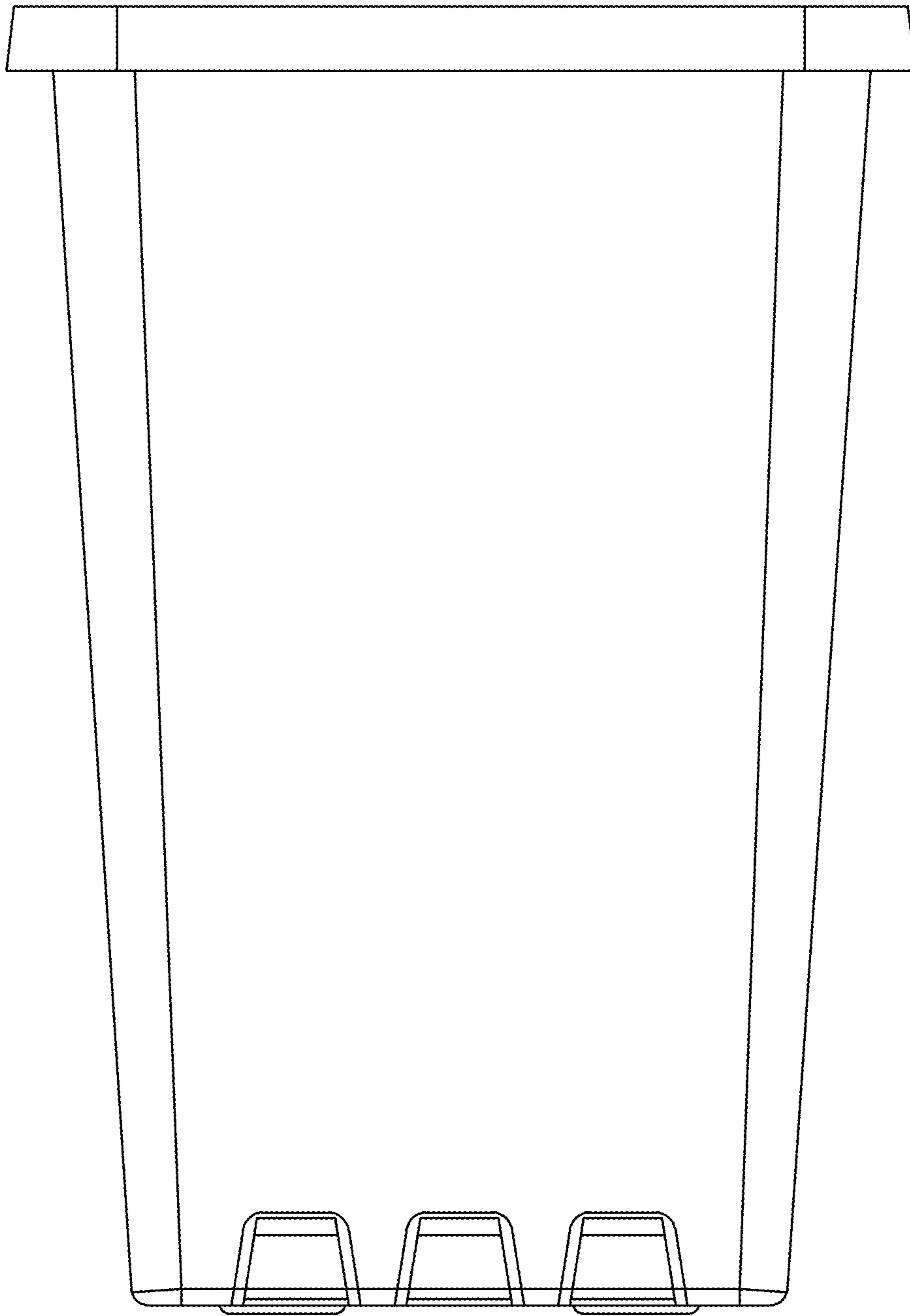

FIG. 5

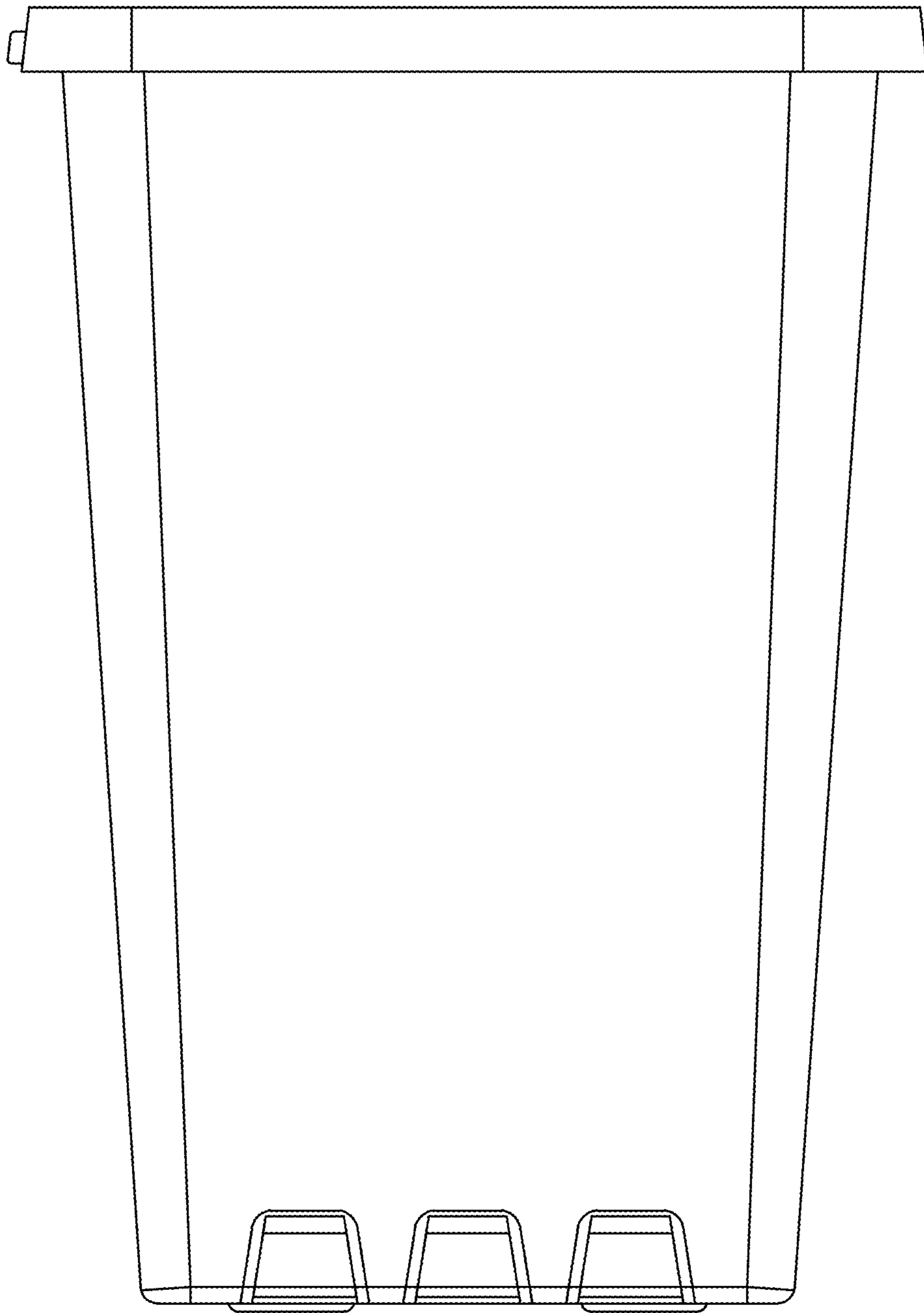

FIG. 6

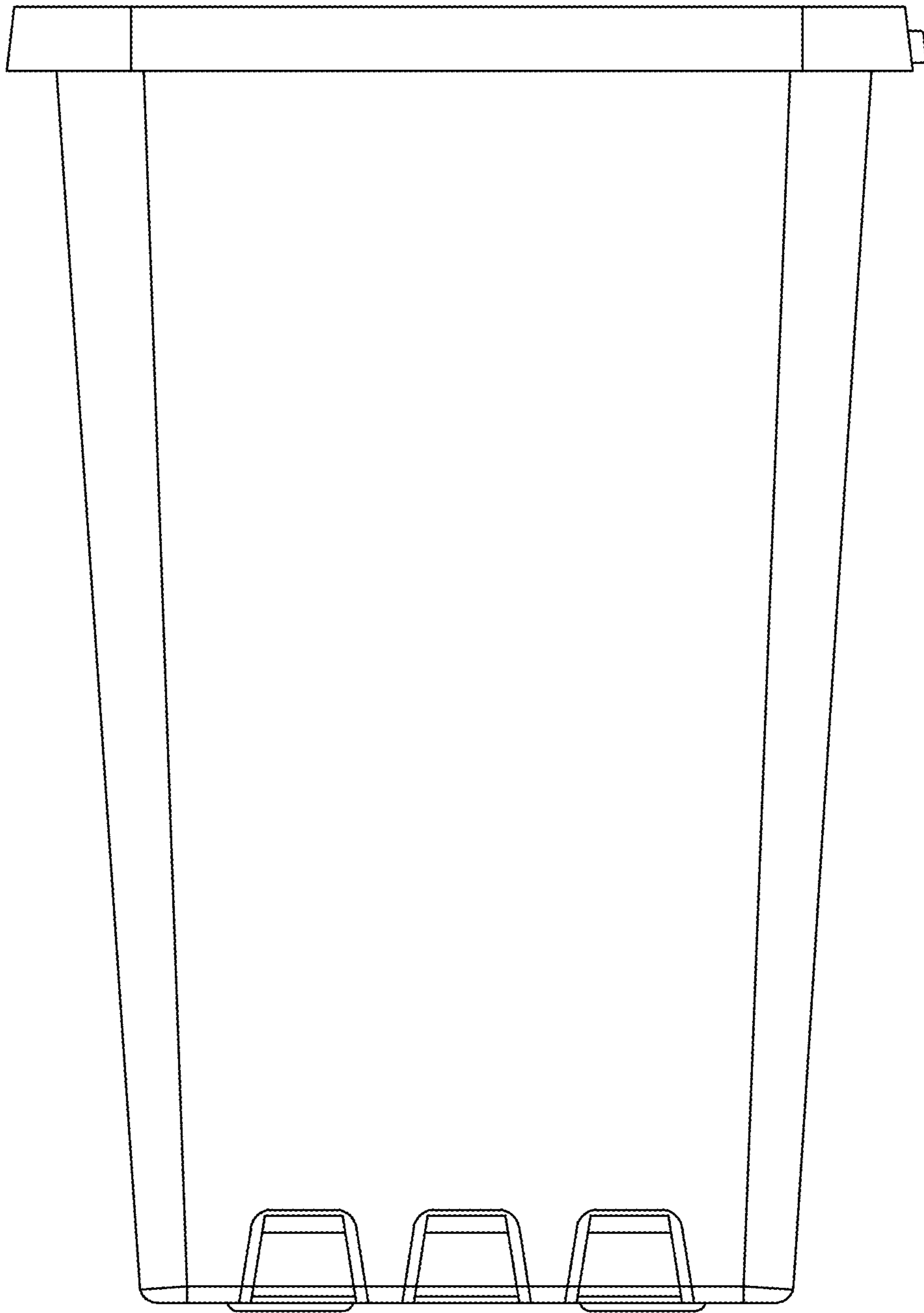

FIG. 7

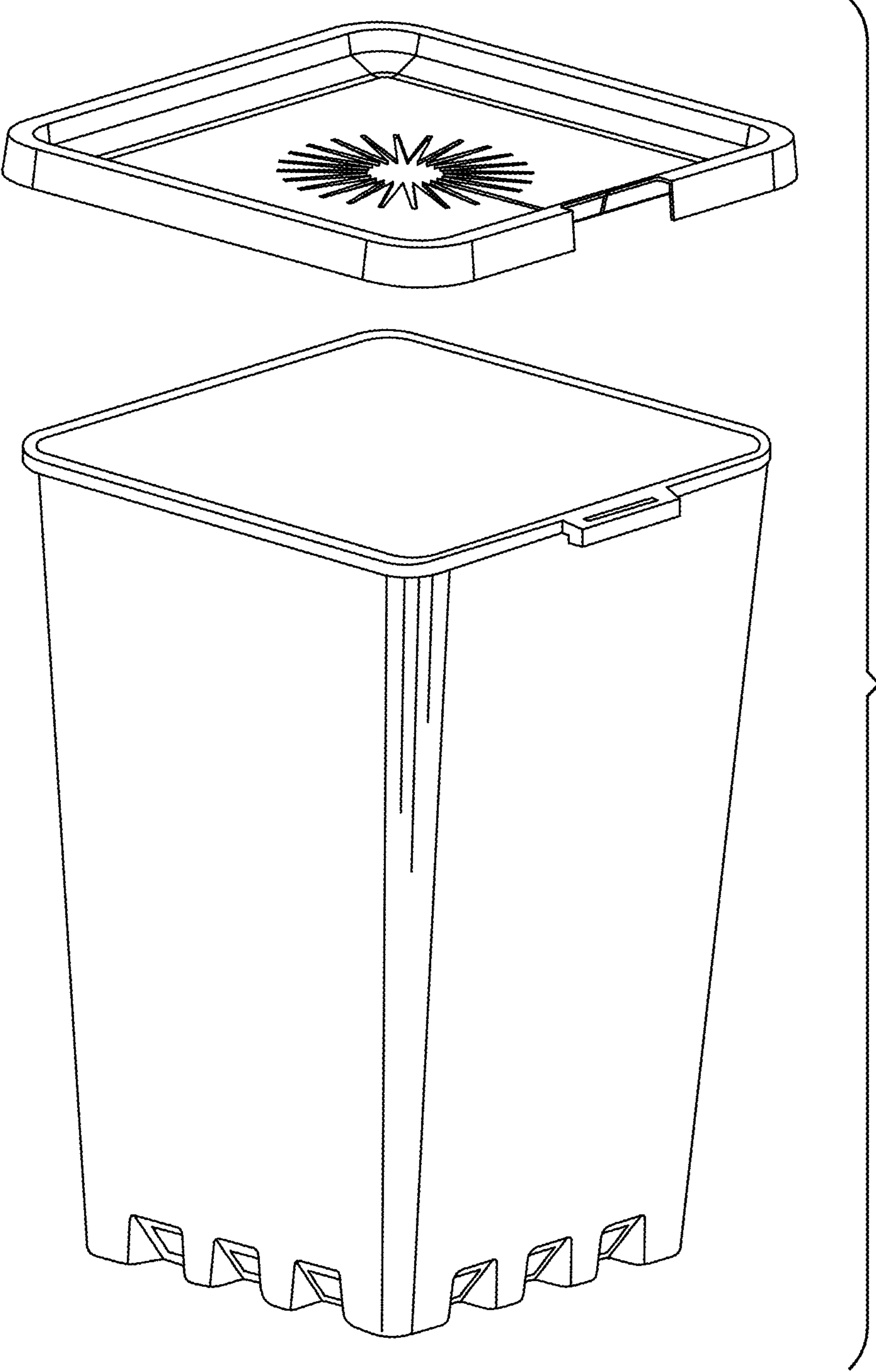

FIG. 8

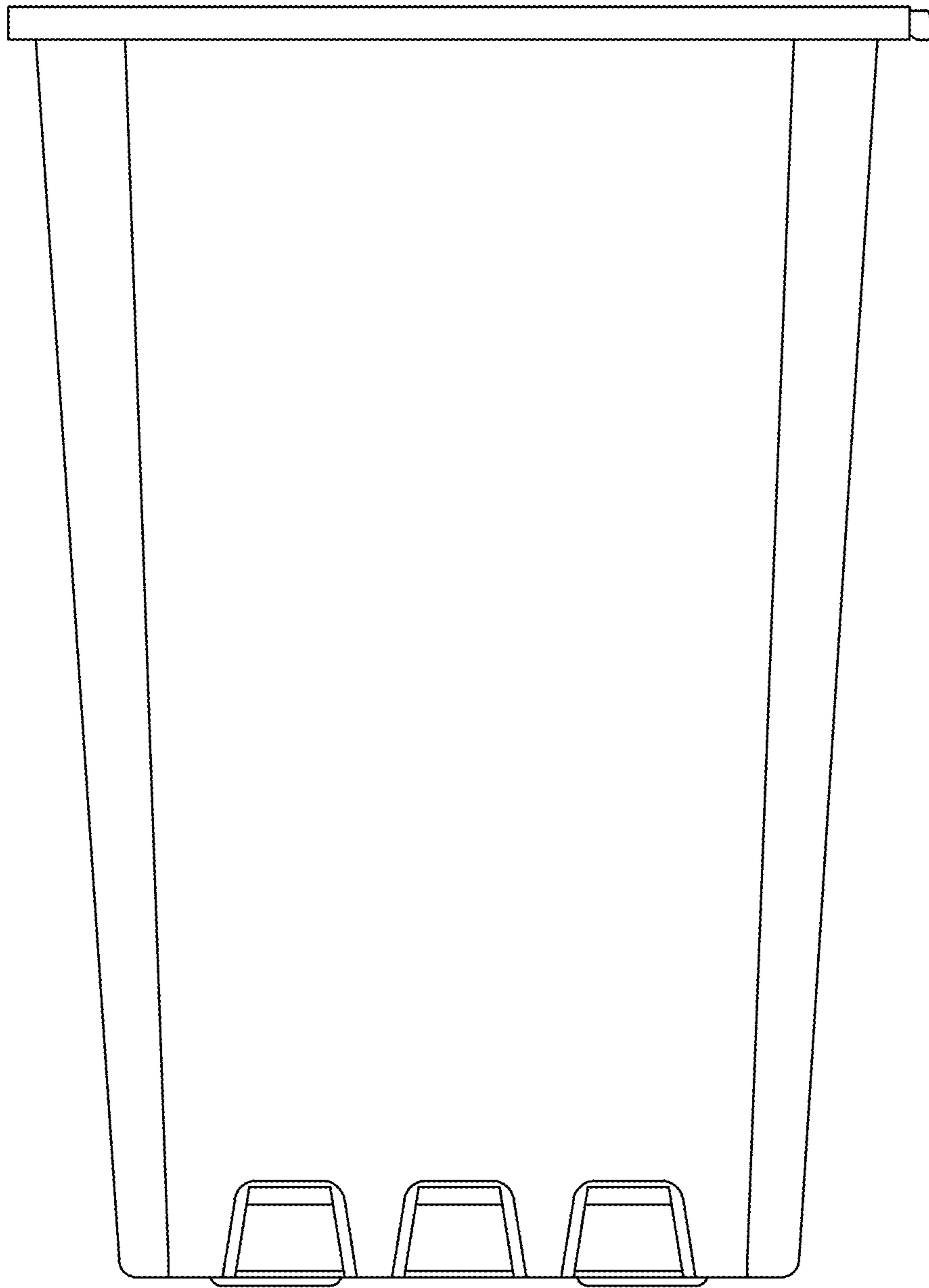

FIG. 9

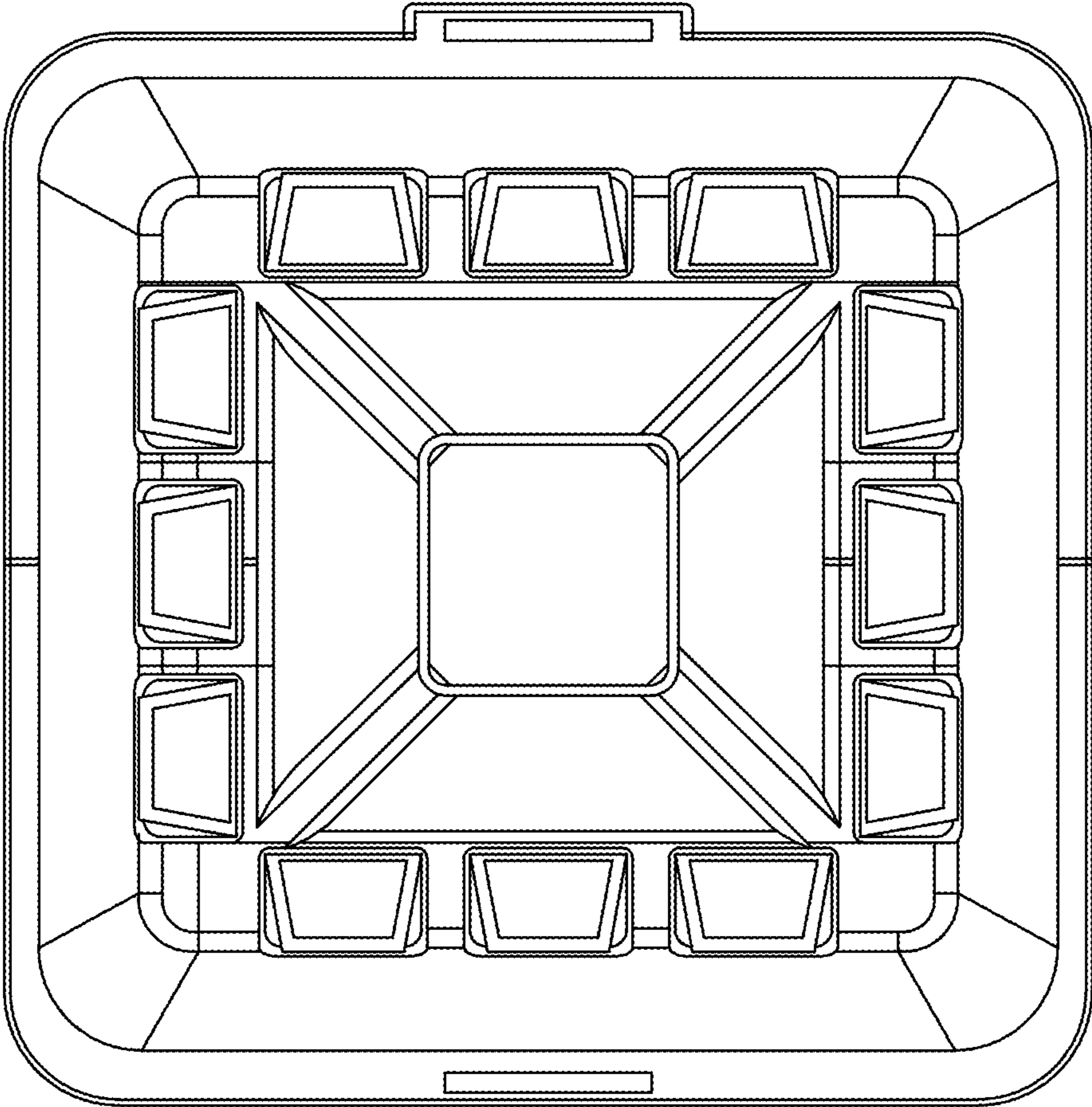

FIG. 10

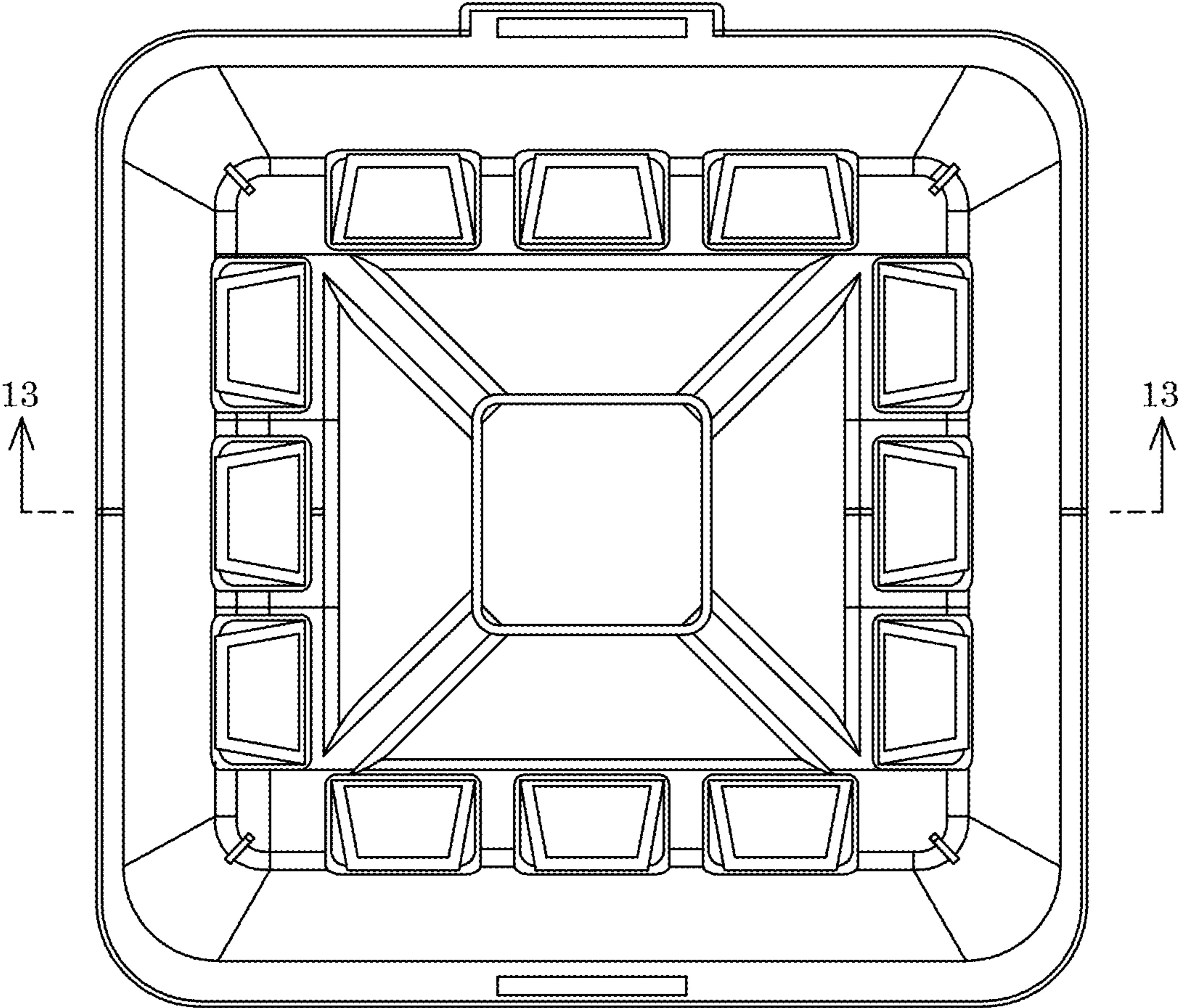

FIG. 11

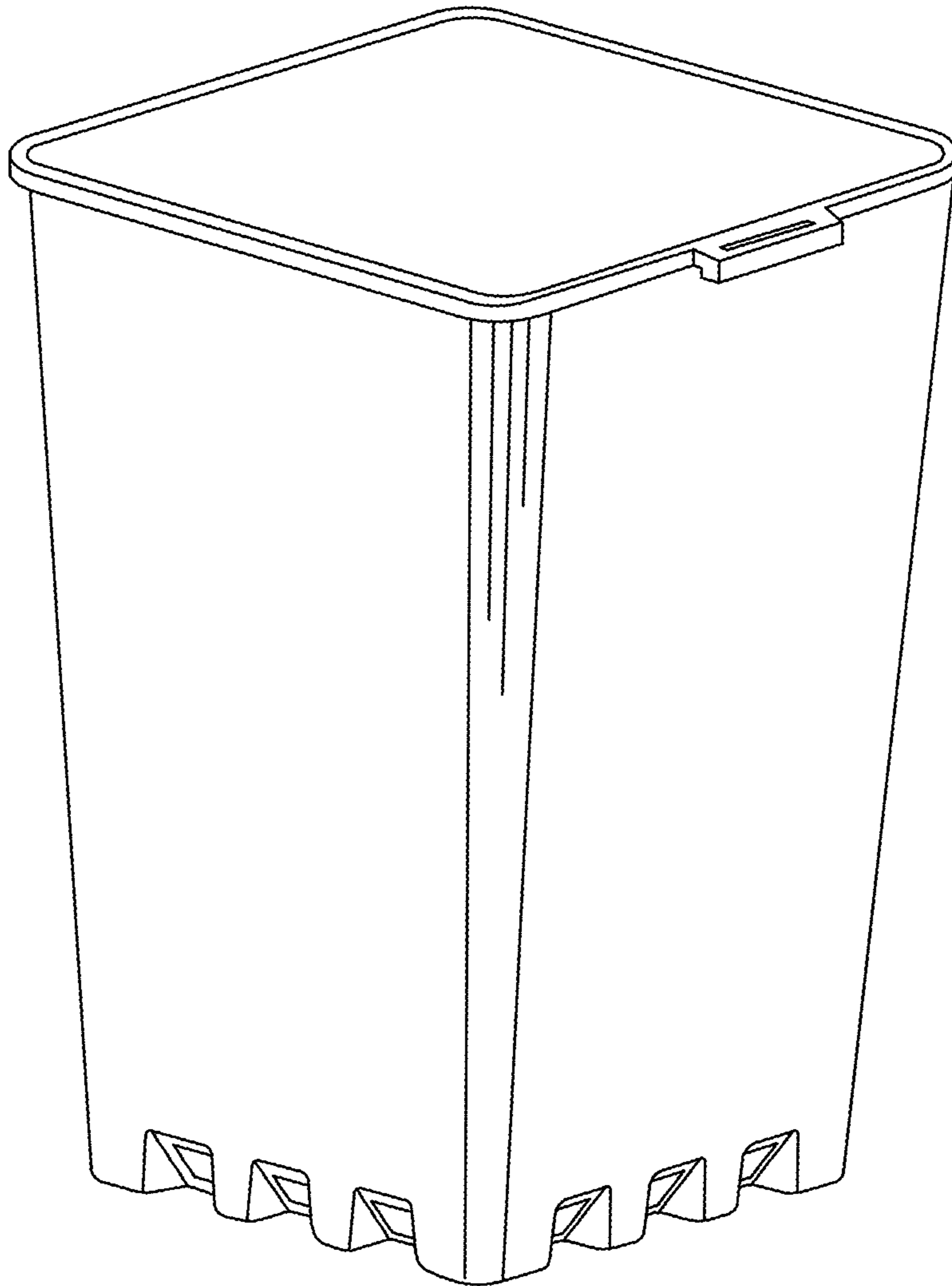

FIG. 12

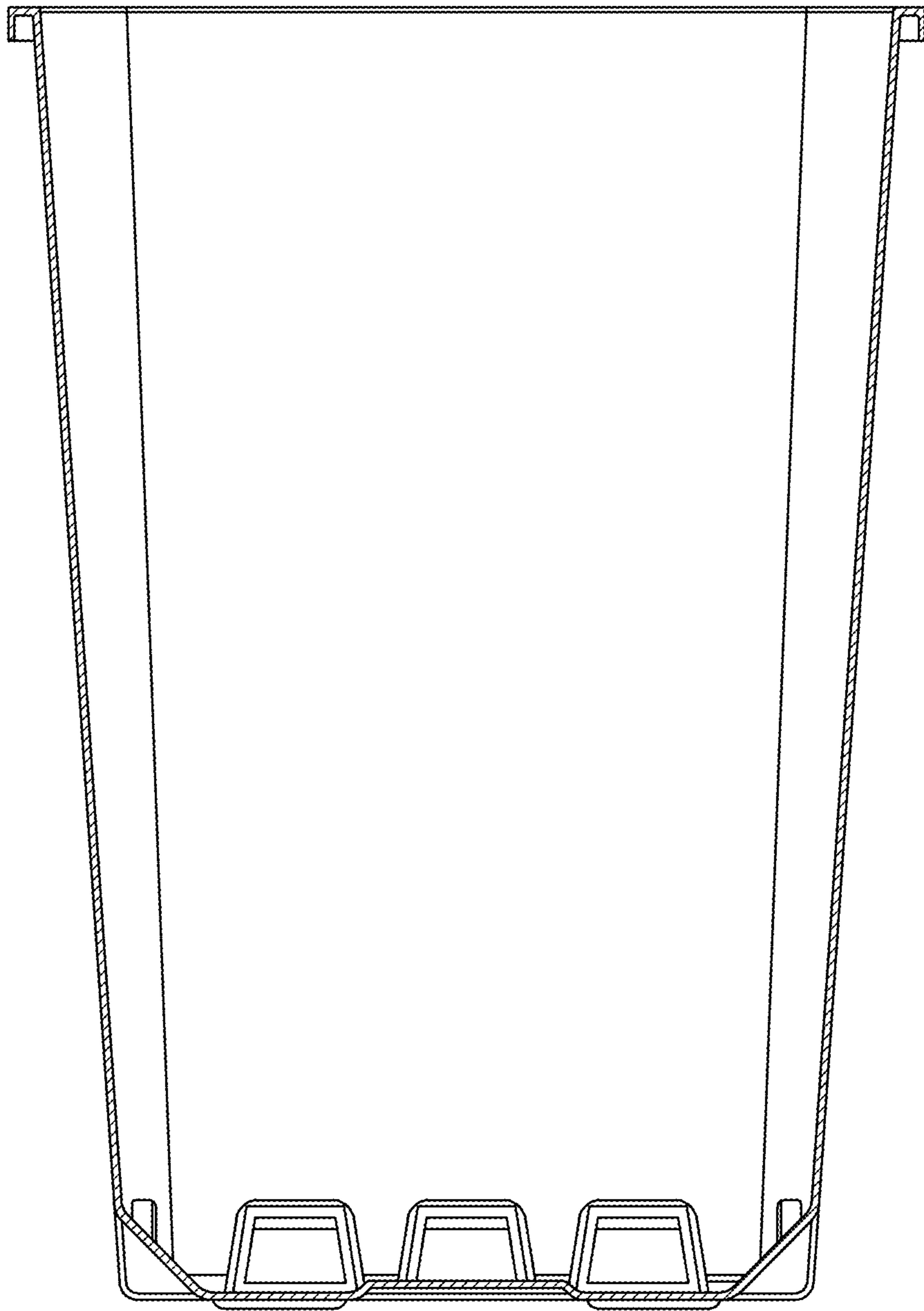

FIG. 13

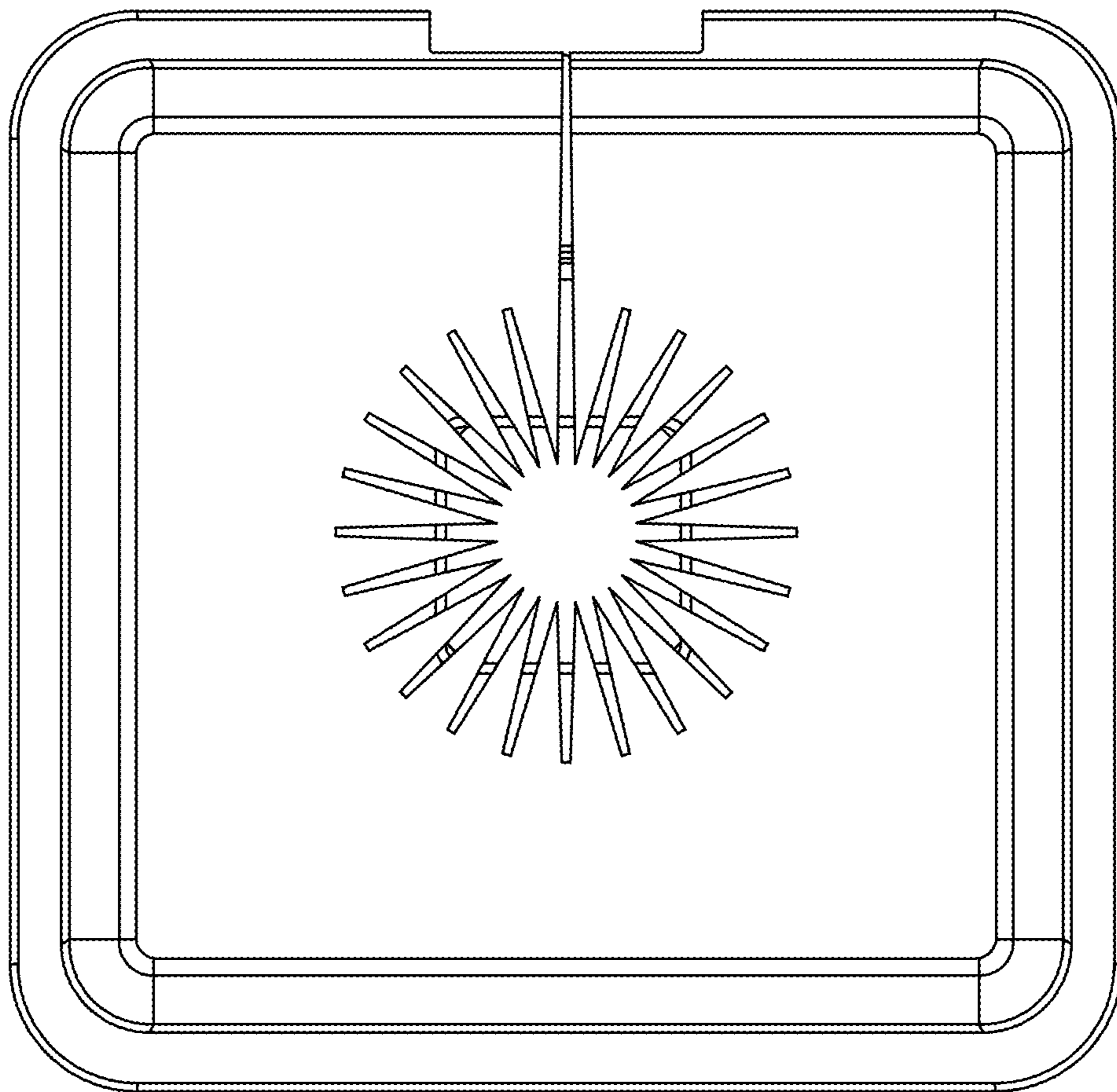

FIG. 14

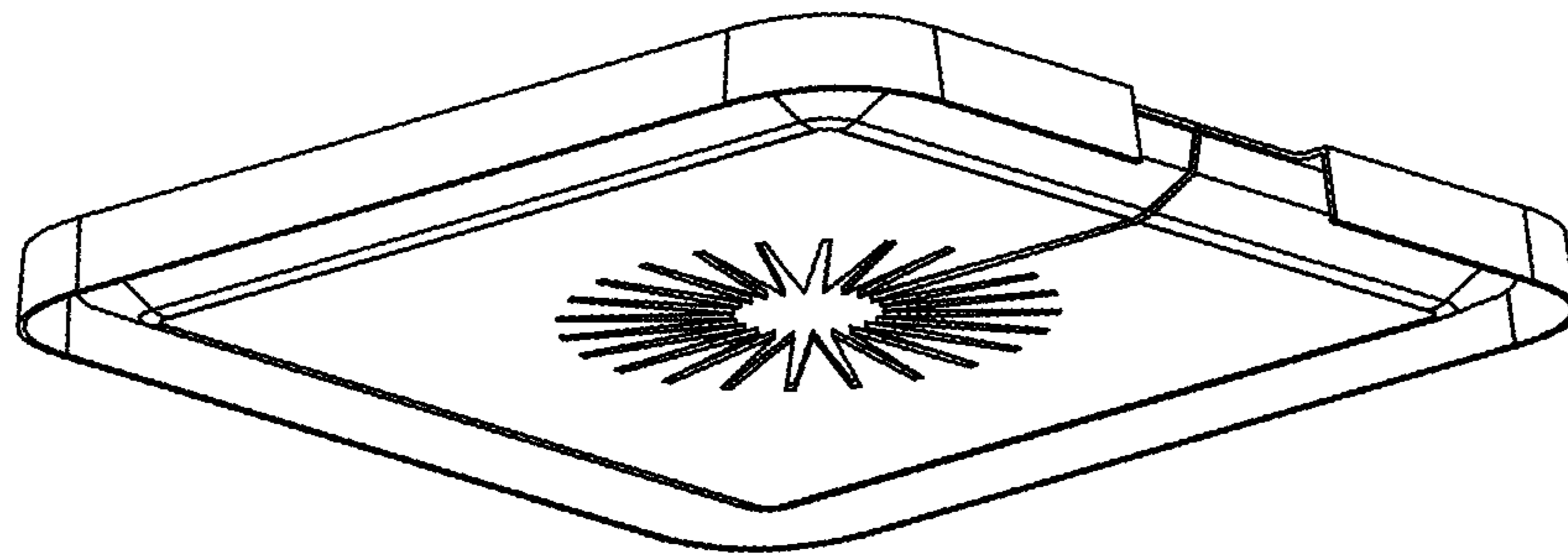

FIG. 15

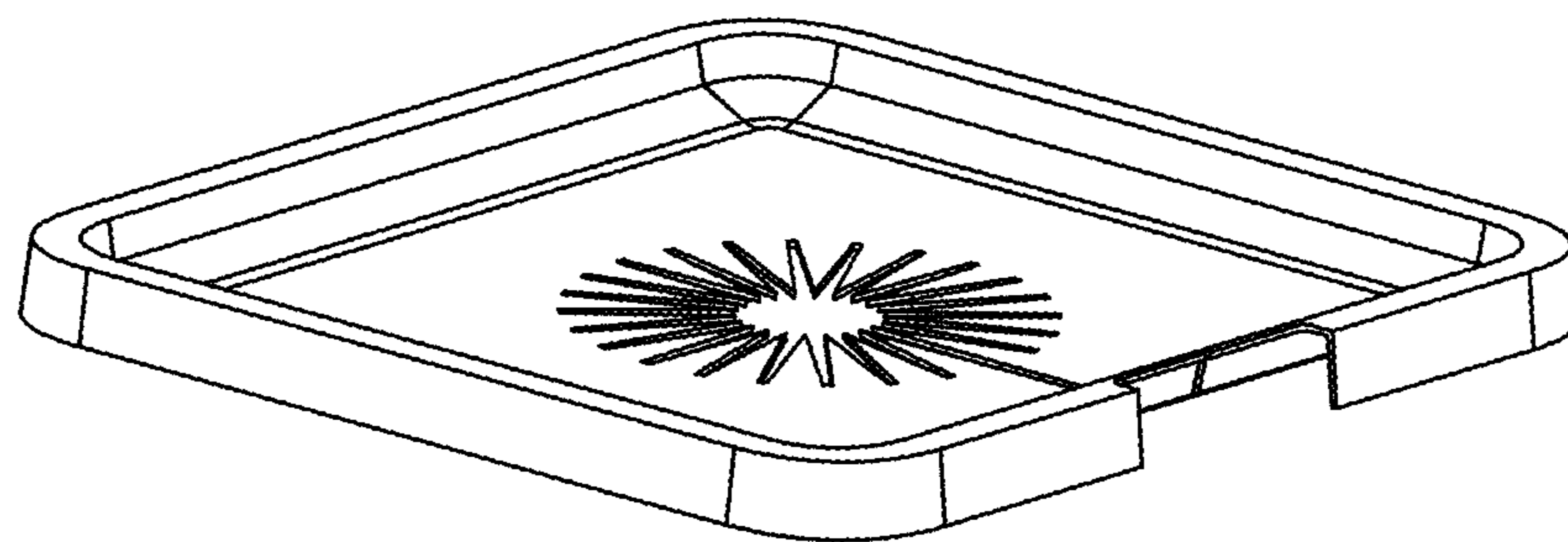

FIG. 16

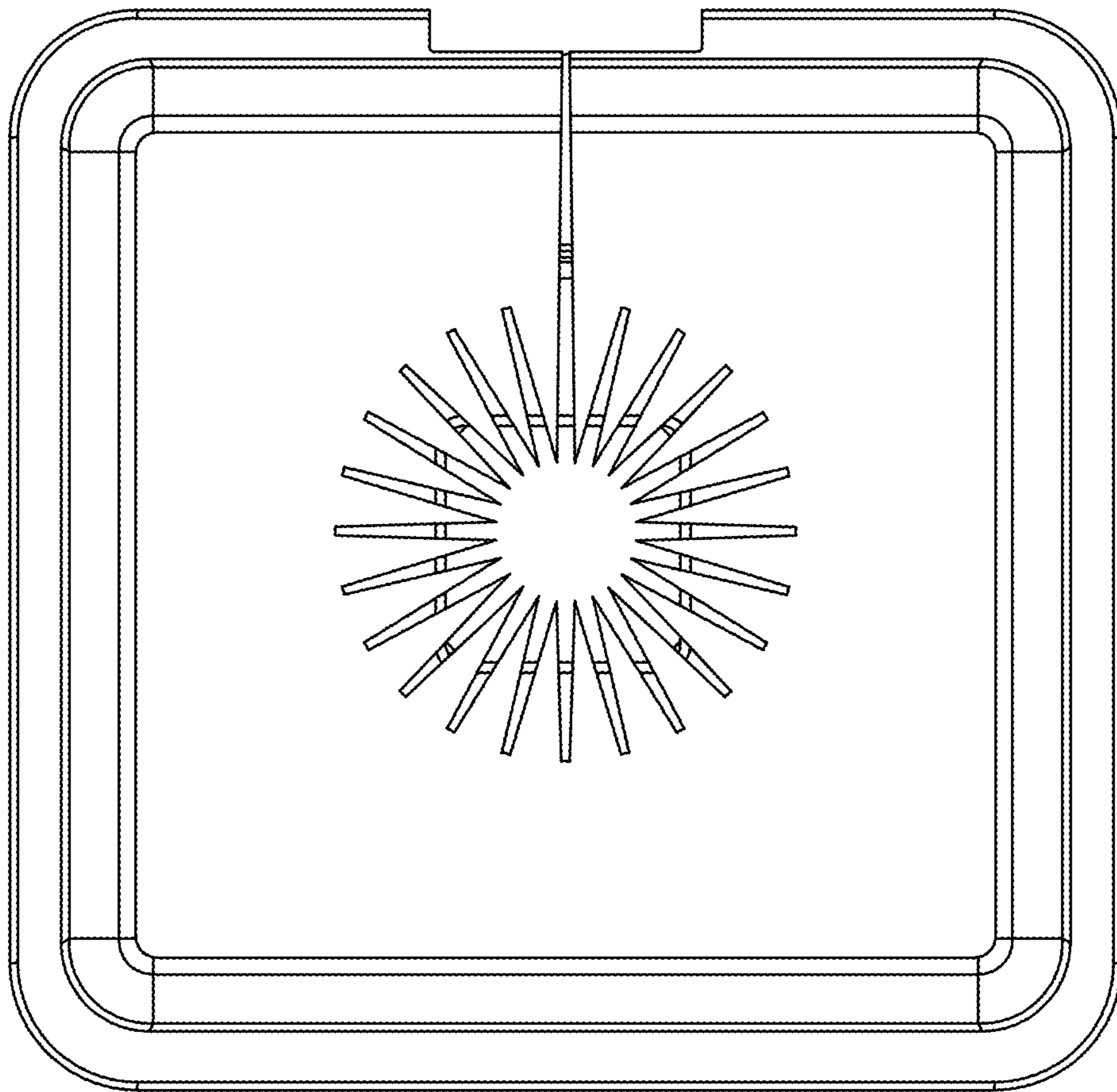

FIG. 17



FIG. 18