



US00D912515S

(12) **United States Design Patent** (10) **Patent No.:** **US D912,515 S**
Alvarez et al. (45) **Date of Patent:** **** Mar. 9, 2021**

(54) **BOTTLE**
(71) Applicant: **PepsiCo, Inc.**, Purchase, NY (US)
(72) Inventors: **Michel Alvarez**, Miami, FL (US);
Carlos Hernan Marina, Key Biscayne, FL (US)

D554,000 S 10/2007 Walsh
D560,501 S 1/2008 Kim et al.
D561,037 S 2/2008 Boon
D571,223 S 6/2008 Imperato et al.
D611,817 S * 3/2010 Simmons D9/504
D612,740 S 3/2010 Leone
D622,145 S 8/2010 Walsh
(Continued)

(73) Assignee: **PepsiCo Inc.**, Purchase, NY (US)

FOREIGN PATENT DOCUMENTS

(**) Term: **15 Years**

CN 304287245 S 9/2017
EM 004733384-0001 12/2018

(21) Appl. No.: **29/697,247**

(Continued)

(22) Filed: **Jul. 5, 2019**

OTHER PUBLICATIONS

(51) **LOC (13) Cl.** **09-01**

(52) **U.S. Cl.**
USPC **D9/503**; D9/454

Shaker/Bottle Blank, cmog.org, acirca 1920-1960, © 2002 Corning Museum of Glass [online]. Available from Internet, <<http://www.cmog.org/search/site/90.4.394>>.

(58) **Field of Classification Search**
USPC D9/434-437, 444-445, 454, 500, 503,
D9/505, 516, 544-545, 549, 558, 682,
D9/690-692, 715, 719; D28/91.1;
D19/162
CPC B65D 1/00; B65D 1/02; B65D 1/0223;
B65D 23/00; B65D 2501/00; B65D
2501/0009

(Continued)

Primary Examiner — Dana Meyrow
(74) *Attorney, Agent, or Firm* — Sterne, Kessler,
Goldstein & Fox P.L.L.C.

See application file for complete search history.

(57) **CLAIM**

The ornamental design for a bottle, as shown and described.

(56) **References Cited**

DESCRIPTION

U.S. PATENT DOCUMENTS

D290,999 S 7/1987 Novak
D337,526 S * 7/1993 Teo D9/443
D391,169 S * 2/1998 Workman D9/539
D433,336 S 11/2000 Weber
D445,033 S 3/2001 Bretz et al.
D438,456 S 7/2001 Bretz et al.
D467,179 S 12/2002 Nelson et al.
D509,984 S 6/2005 Zboch et al.
D506,139 S 9/2005 Zboch et al.
D509,747 S 9/2005 Carlson et al.
D515,430 S 2/2006 Venkataraman et al.
D525,138 S 7/2006 Shmagin et al.

FIG. 1 is a top perspective view of a bottle showing the claimed design;
FIG. 2 is a bottom perspective view thereof;
FIG. 3 is a front view thereof;
FIG. 4 is a rear view thereof;
FIG. 5 is a left side view thereof;
FIG. 6 is a right side view thereof;
FIG. 7 is a top view thereof; and,
FIG. 8 is a bottom view thereof.

1 Claim, 5 Drawing Sheets

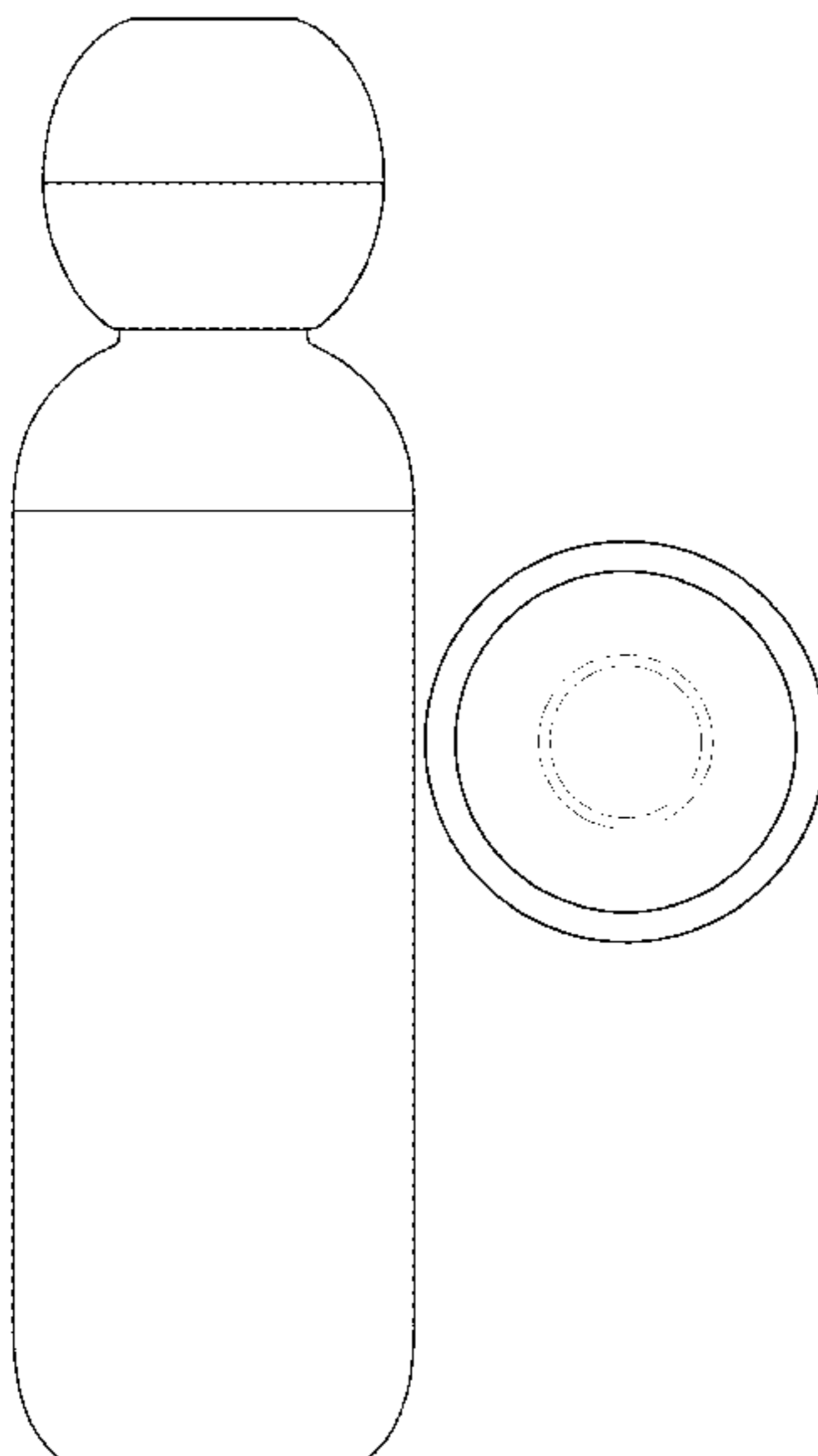

US D912,515 S

Page 2

(56)

References Cited

U.S. PATENT DOCUMENTS

D623,063 S 9/2010 Pedmo
D626,851 S 11/2010 Aquah
8,016,148 B2 9/2011 Walsh
D695,616 S * 12/2013 Li D9/503
D696,945 S 1/2014 Newman
D697,407 S 1/2014 Hines
D702,553 S 4/2014 Jentzsch et al.
D704,558 S 5/2014 Weiss
D704,559 S 5/2014 Weiss
D785,455 S 5/2017 James et al.
D789,795 S 6/2017 Boon
D803,060 S 11/2017 Marina et al.
D804,906 S * 12/2017 Diener D7/510
D808,812 S 1/2018 Talsania et al.
D819,403 S * 6/2018 Li D7/510
D829,101 S * 9/2018 Spivey D9/504
D839,683 S * 2/2019 Wong D7/608

D845,131 S * 4/2019 Moretti D9/500
D848,265 S * 5/2019 Harris D9/500
2013/0193027 A1 8/2013 Poo

FOREIGN PATENT DOCUMENTS

JP 1252737 S 10/2005
KR 30-0448469 5/2007
KR 30-0557317 4/2010
KR 30-0815332 9/2015
RU 54195 3/2004

OTHER PUBLICATIONS

4 oz Boston Round Clear PET Plastic Bottle, packagingoptionsdirect.com, © 2017 TricorBraun, [online]. Available from Internet, <<http://packagingoptionsdirect.com/4-oz-boston-round-clear-pet-plastic-bottle>>.

* cited by examiner

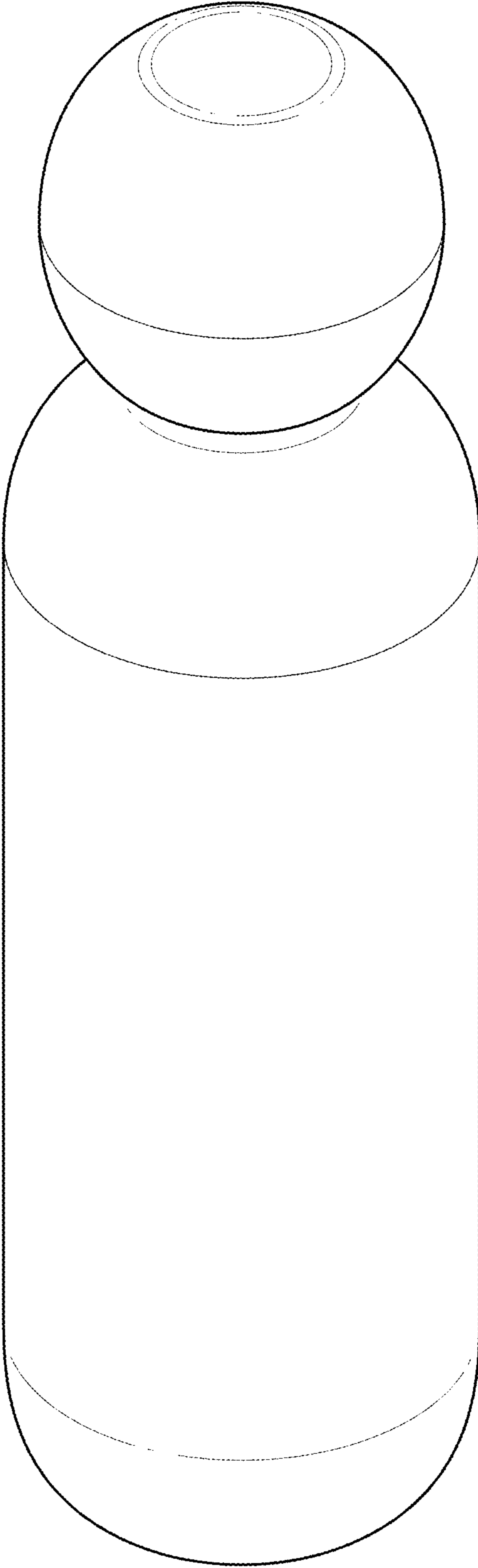

FIG. 1

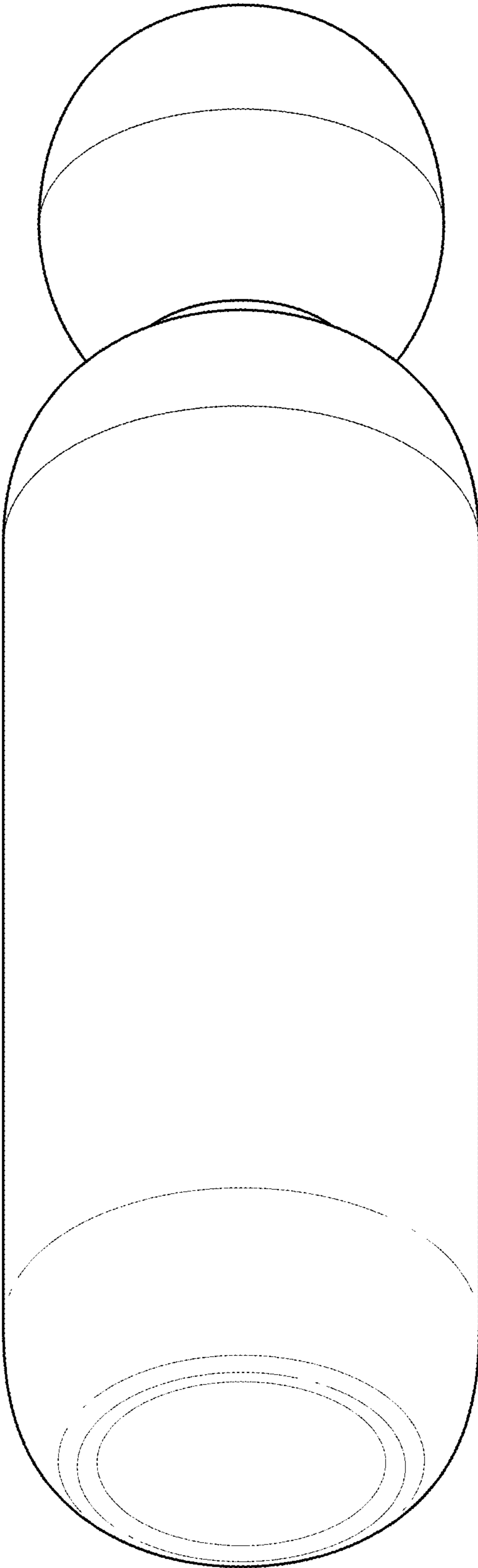

FIG. 2

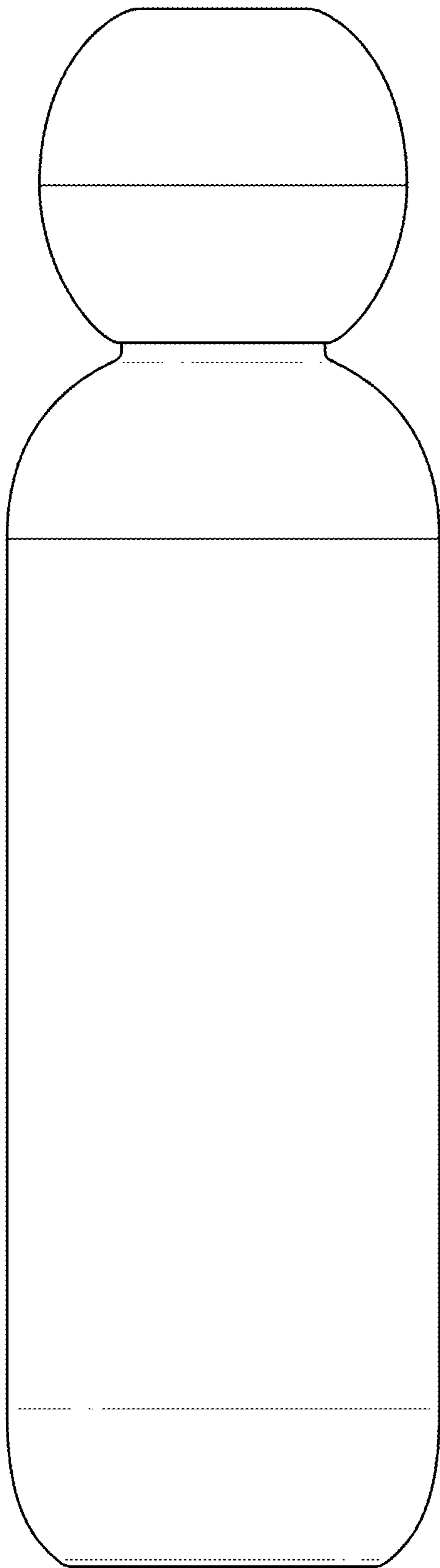

FIG. 3

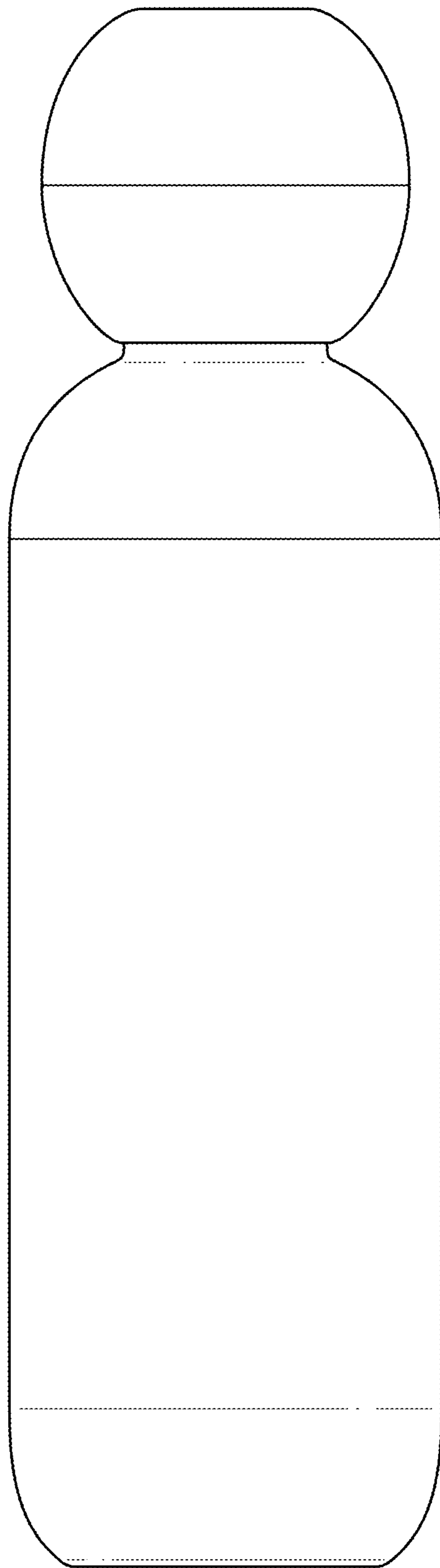

FIG. 4

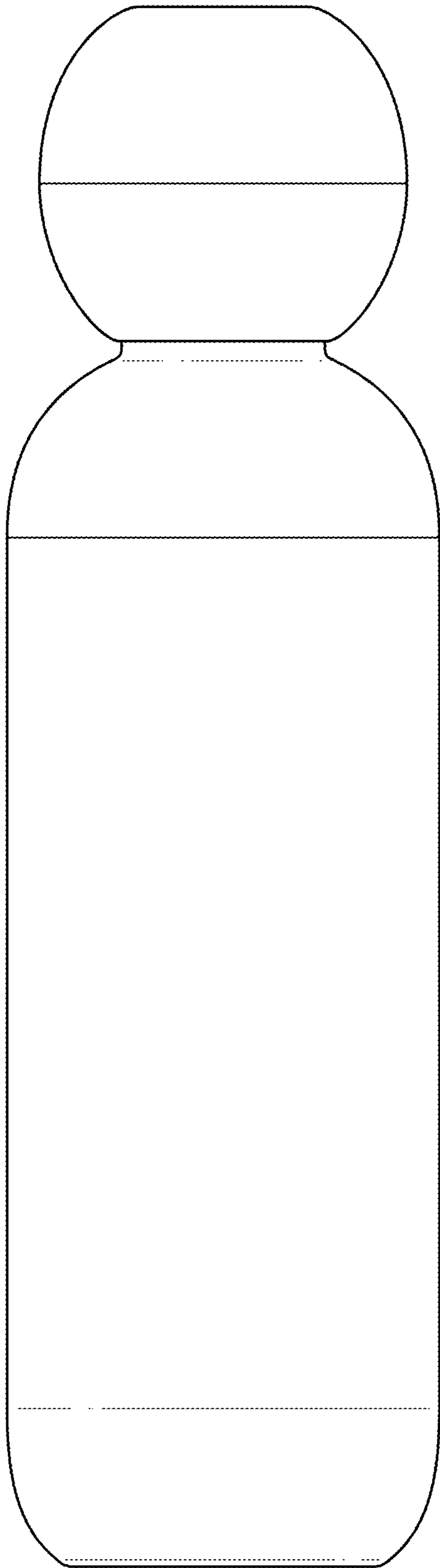

FIG. 5

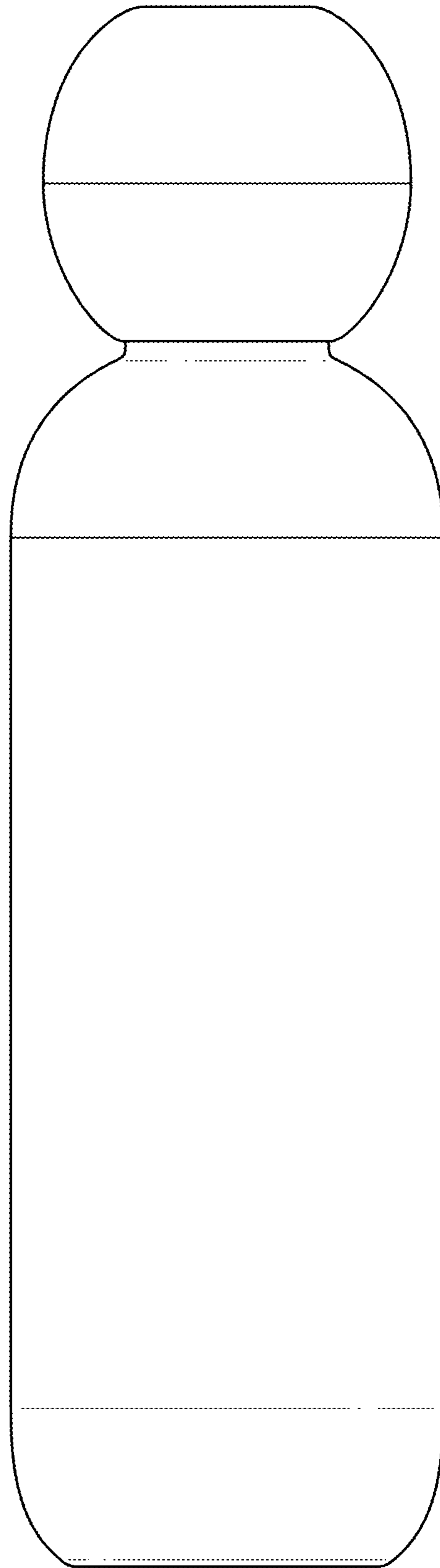

FIG. 6

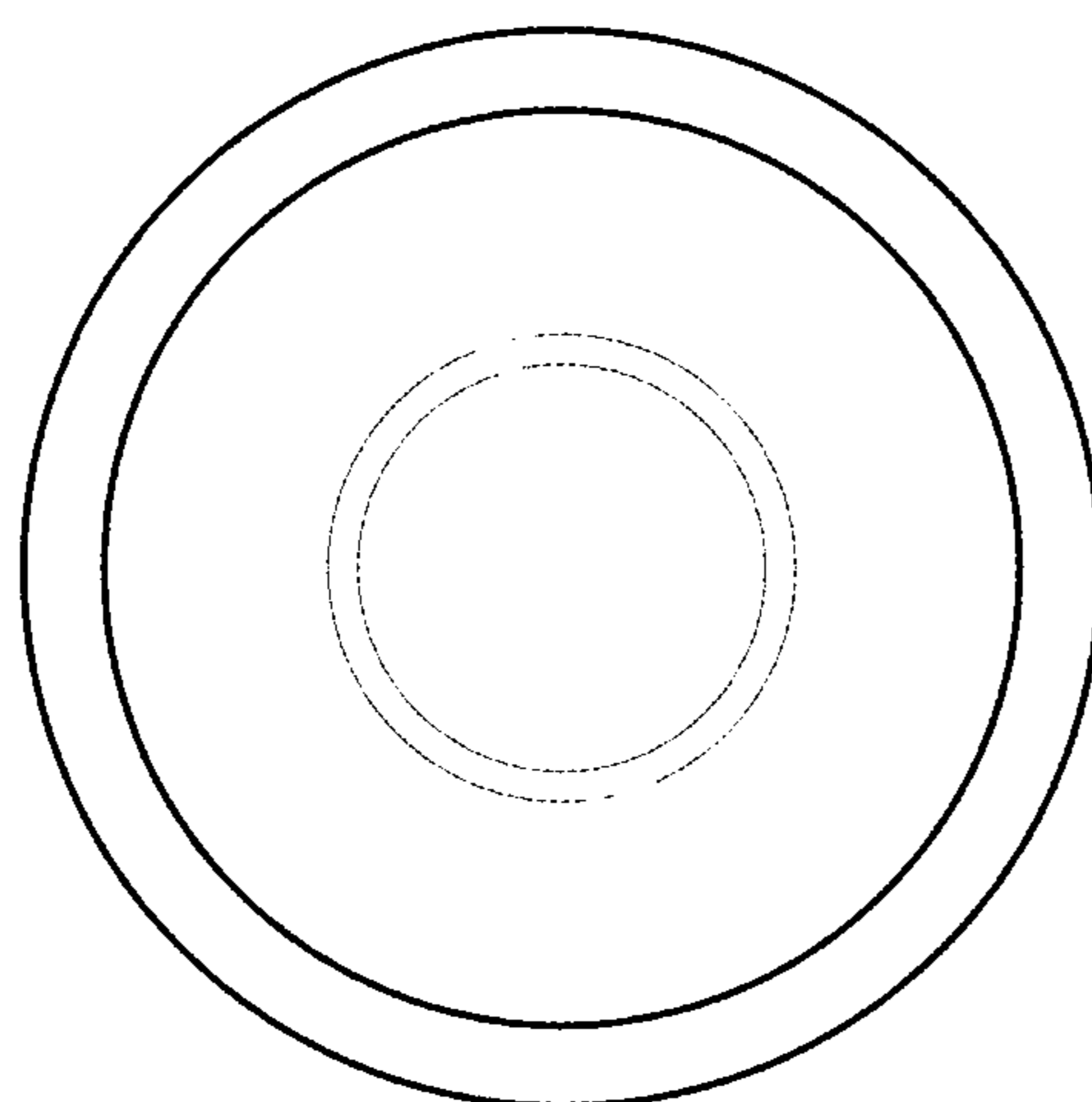

FIG. 7

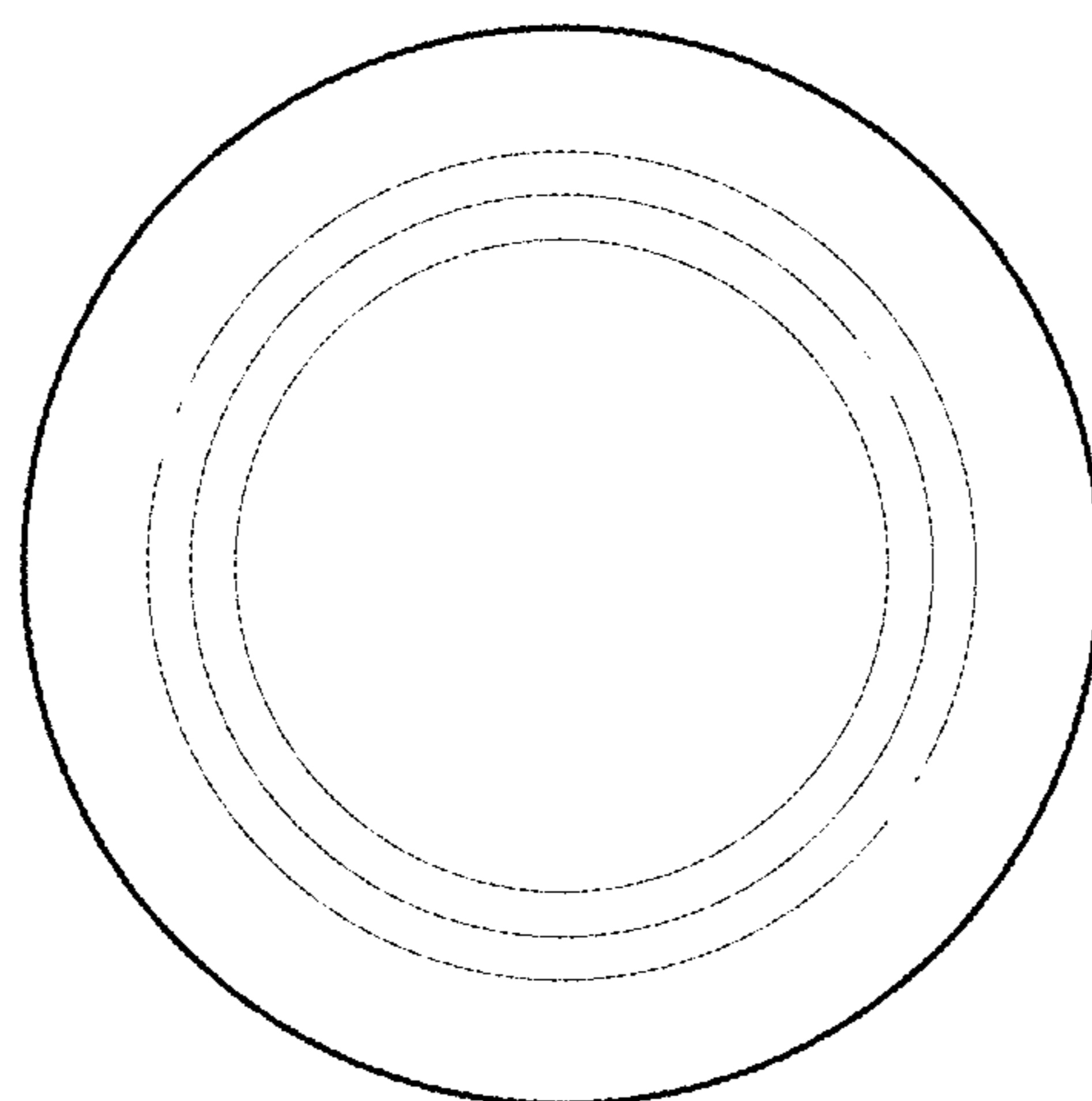

FIG. 8