



US00D912475S

(12) **United States Design Patent** (10) **Patent No.:** **US D912,475 S**
Boroski et al. (45) **Date of Patent:** **** Mar. 9, 2021**

(54) **FOOD CONTAINER**

(74) *Attorney, Agent, or Firm* — Polsinelli PC

(71) Applicant: **THERMOS L.L.C.**, Schaumburg, IL (US)

(57) **CLAIM**

The ornamental design for a food container, as shown and described.

(72) Inventors: **Dwayne Boroski**, Lake in the Hills, IL (US); **Freddy Aranda**, Chicago, IL (US)

DESCRIPTION

(73) Assignee: **Thermos L.L.C.**, Schaumburg, IL (US)

(**) Term: **15 Years**

FIG. 1 is a perspective view of a first embodiment of the food container;

(21) Appl. No.: **29/699,050**

FIG. 2 is a top view of the first embodiment of the food container;

(22) Filed: **Jul. 23, 2019**

FIG. 3 is a bottom view of the first embodiment of the food container;

(51) **LOC (13) Cl.** **07-01**

FIG. 4 is a front view of the first embodiment of the food container;

(52) **U.S. Cl.**

USPC **D7/605**; D7/629

FIG. 5 is a rear view of the first embodiment of the food container;

(58) **Field of Classification Search**

USPC D7/605, 709, 629

FIG. 6 is a right side view of the first embodiment of the food container;

CPC A45C 13/02; A45C 13/1046; A45C 5/02; A45C 11/20; B65D 25/04

FIG. 7 is a left side view of the first embodiment of the food container;

See application file for complete search history.

FIG. 8 is a perspective view of a second embodiment of the food container;

(56) **References Cited**

U.S. PATENT DOCUMENTS

5,706,935 A * 1/1998 Lorton A45C 11/008

150/117

6,112,899 A * 9/2000 Zeringue A45C 11/20

206/541

D472,774 S * 4/2003 Pelstring D7/629

8,328,034 B2 * 12/2012 Miros B65B 7/16

220/4.22

D695,575 S * 12/2013 Katz D7/629

D763,629 S * 8/2016 Swartz D7/629

D801,754 S * 11/2017 Neumann A45C 11/20

D7/629

2010/0224531 A1 * 9/2010 Claffy B65D 81/3823

206/561

FIG. 9 is a top view of the second embodiment of the food container;

FIG. 10 is a bottom view of the second embodiment of the food container;

FIG. 11 is a front view of the second embodiment of the food container;

FIG. 12 is a rear view of the second embodiment of the food container;

FIG. 13 is a right side view of the second embodiment of the food container; and,

FIG. 14 is a left side view of the second embodiment of the food container.

The broken lines showing in the figures are included for the purpose of illustrating portions of the food container that form no part of the claimed design.

(Continued)

Primary Examiner — Terry A Wallace

1 Claim, 12 Drawing Sheets

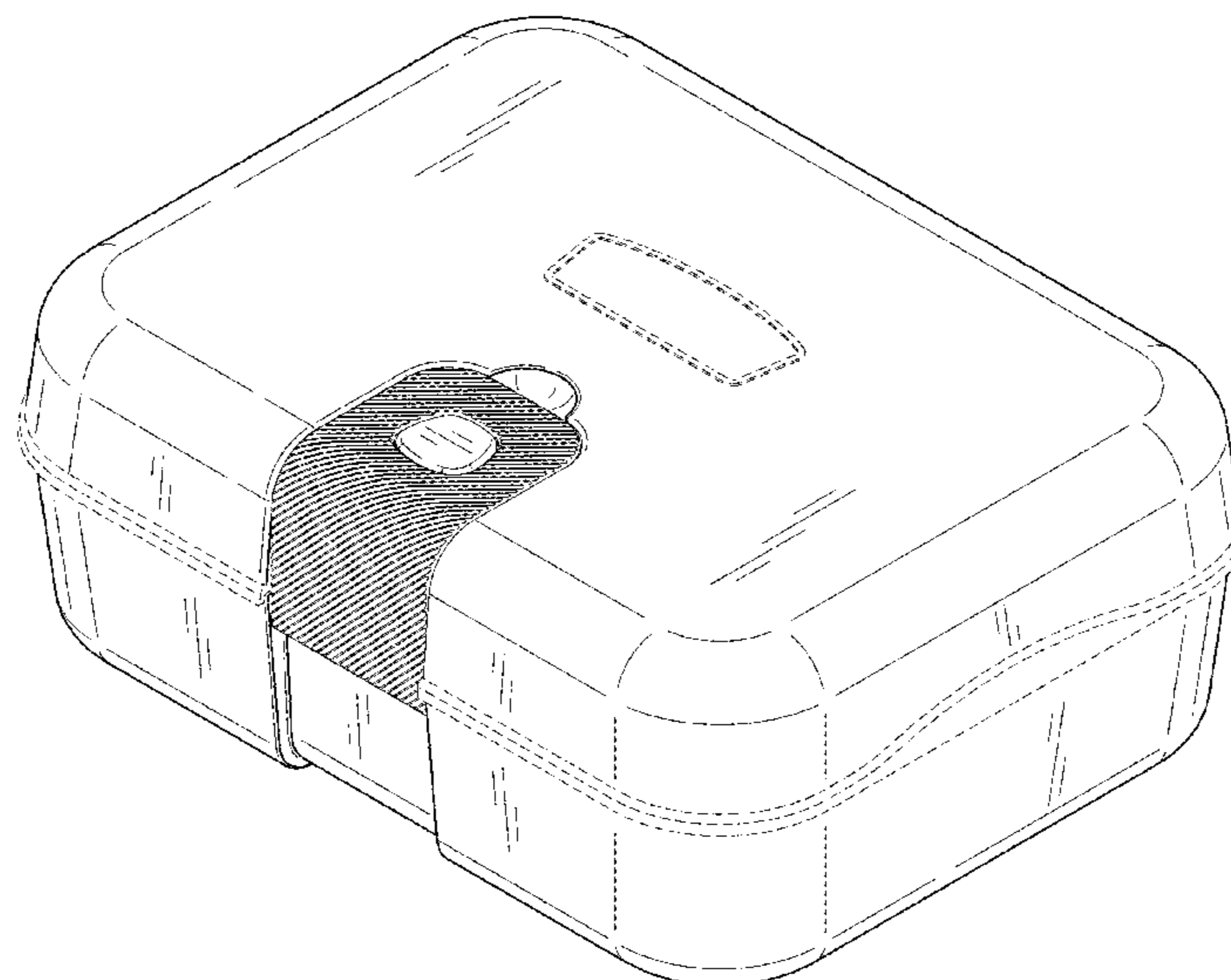

(56)

References Cited

U.S. PATENT DOCUMENTS

2014/0103033 A1* 4/2014 Beckman B65D 43/0212
220/4.01

* cited by examiner

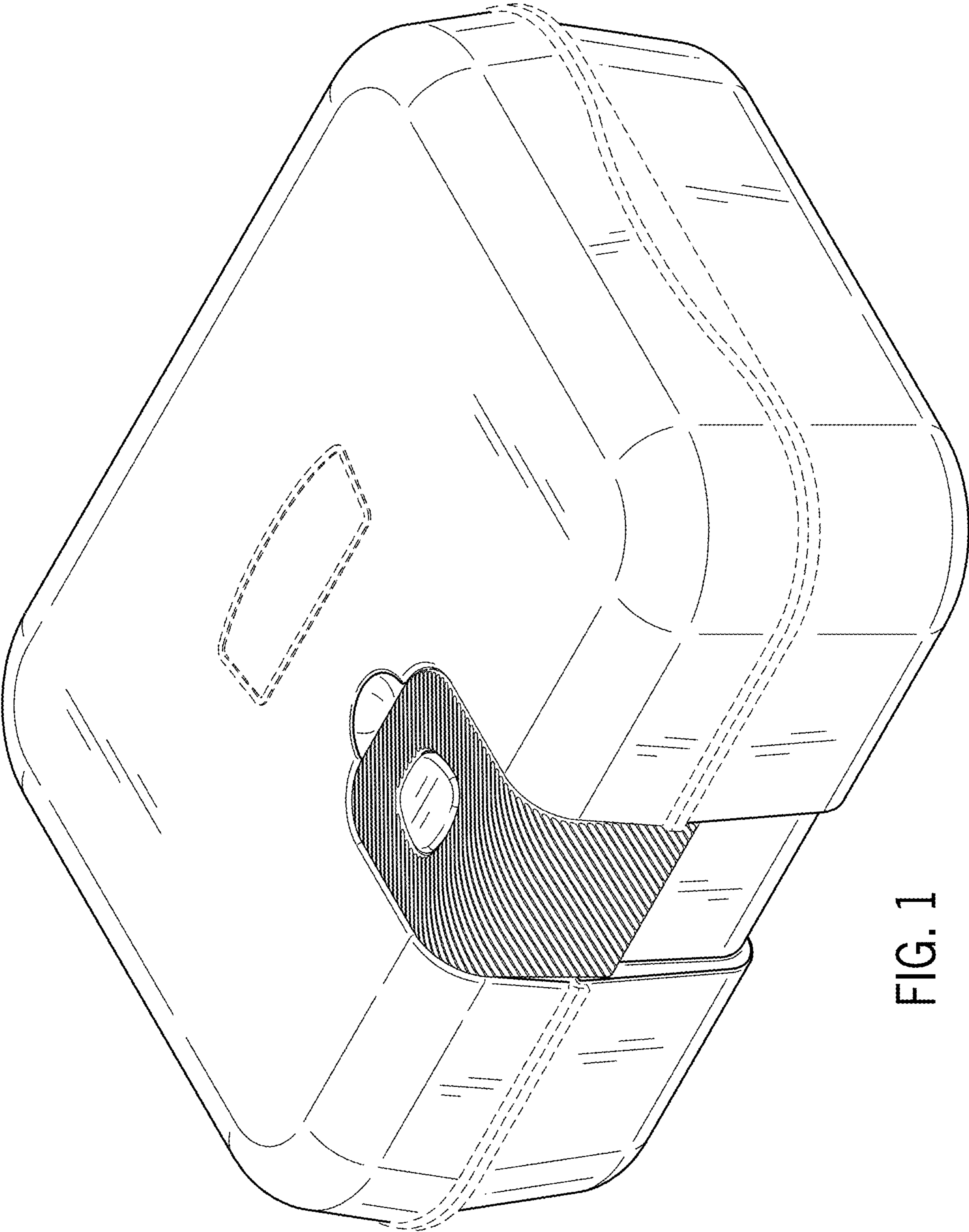

FIG. 1

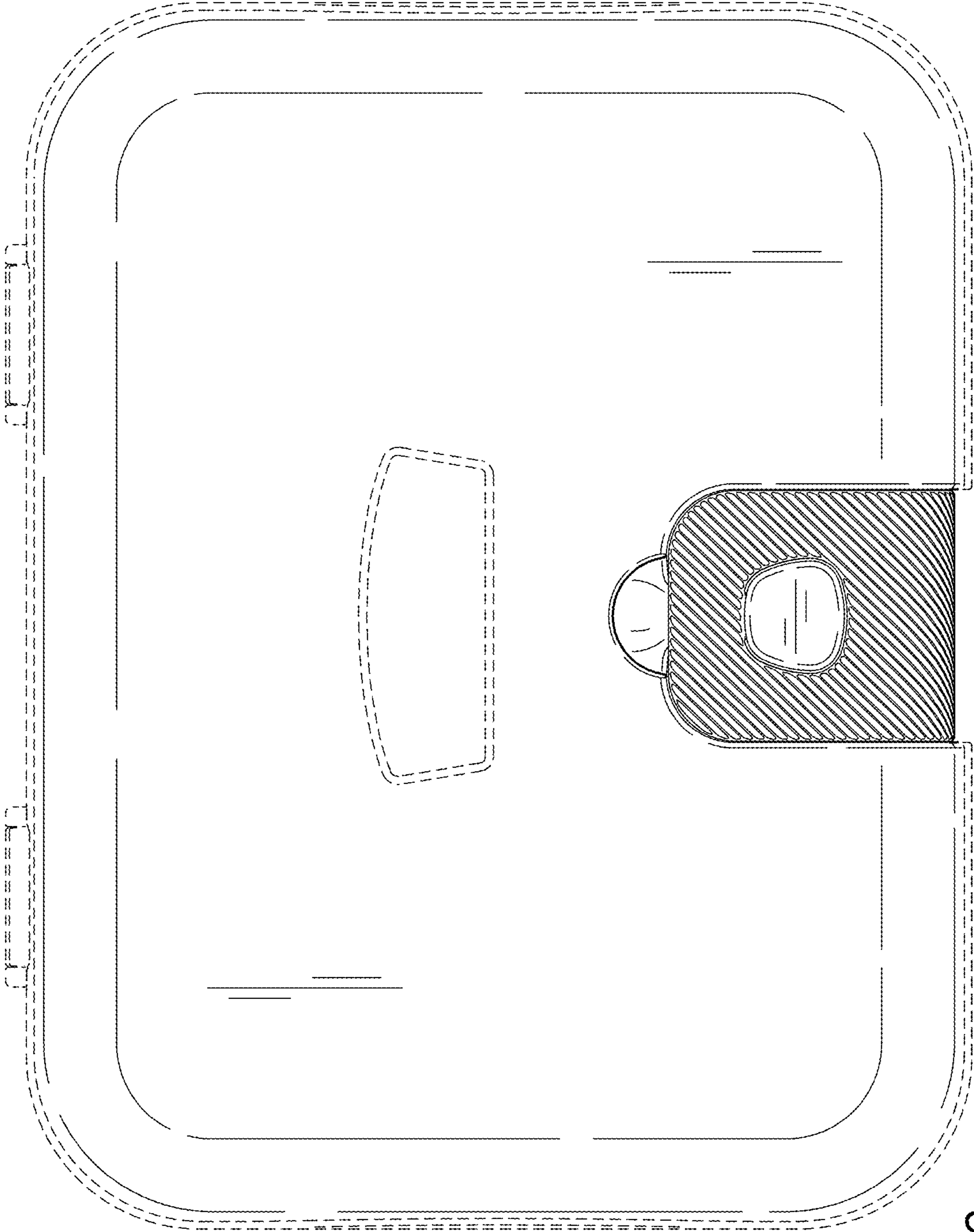

FIG. 2

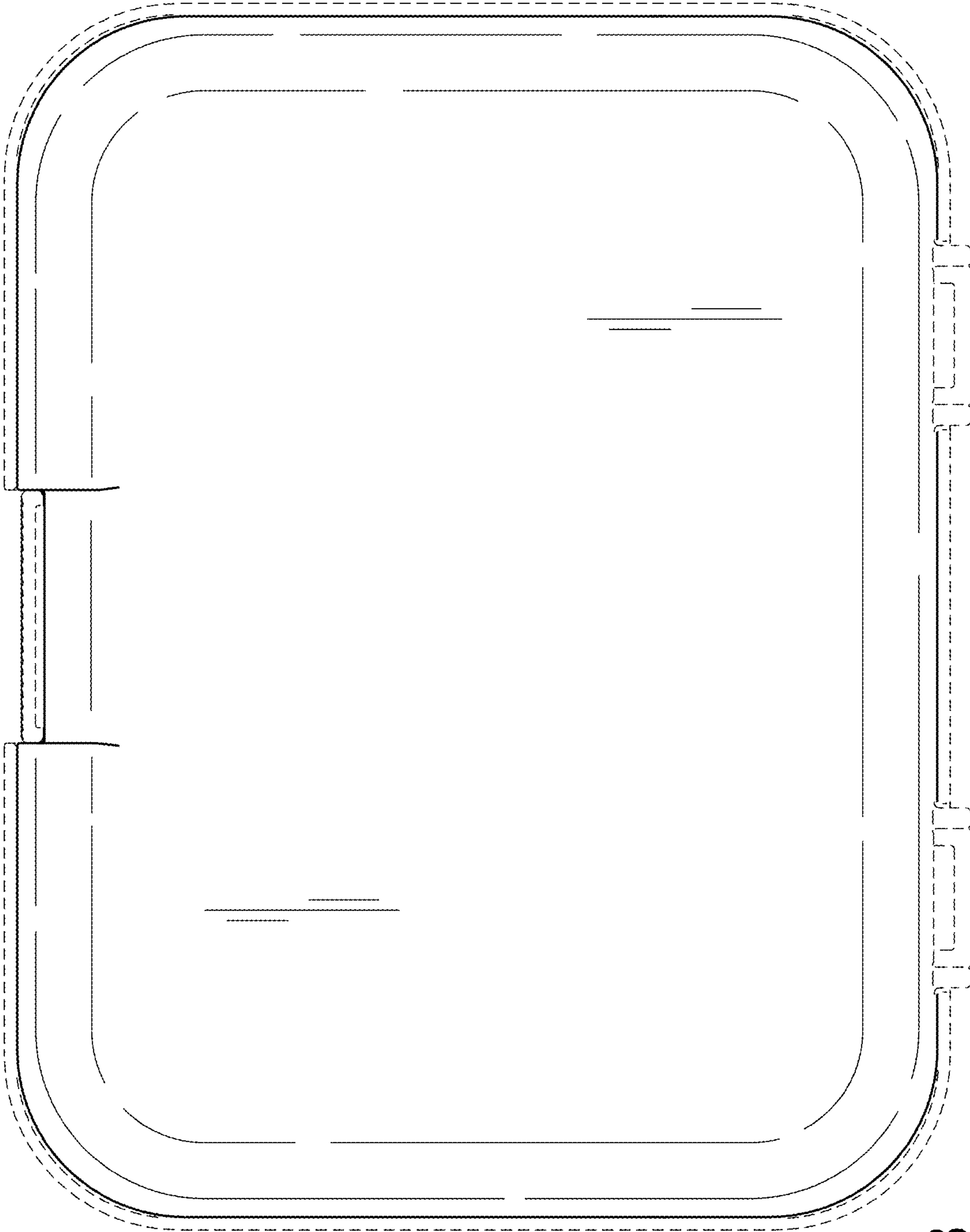

FIG. 3

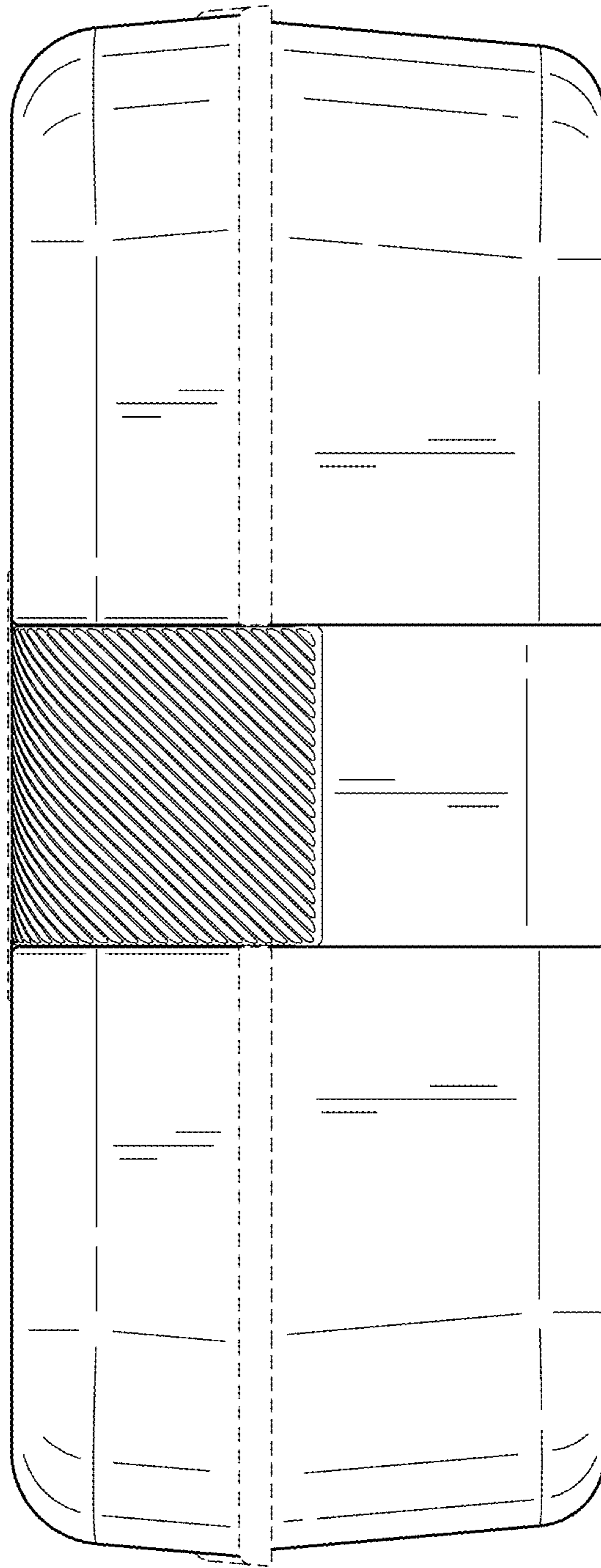

FIG. 4

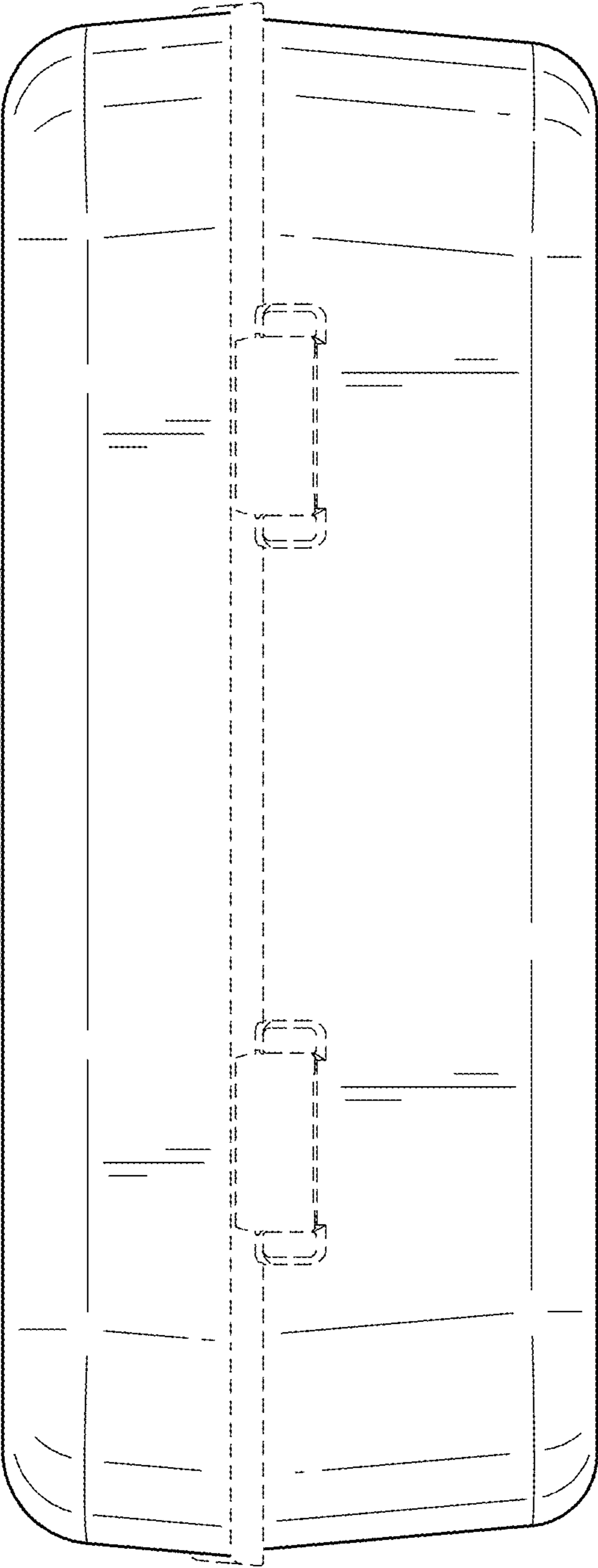

FIG. 5

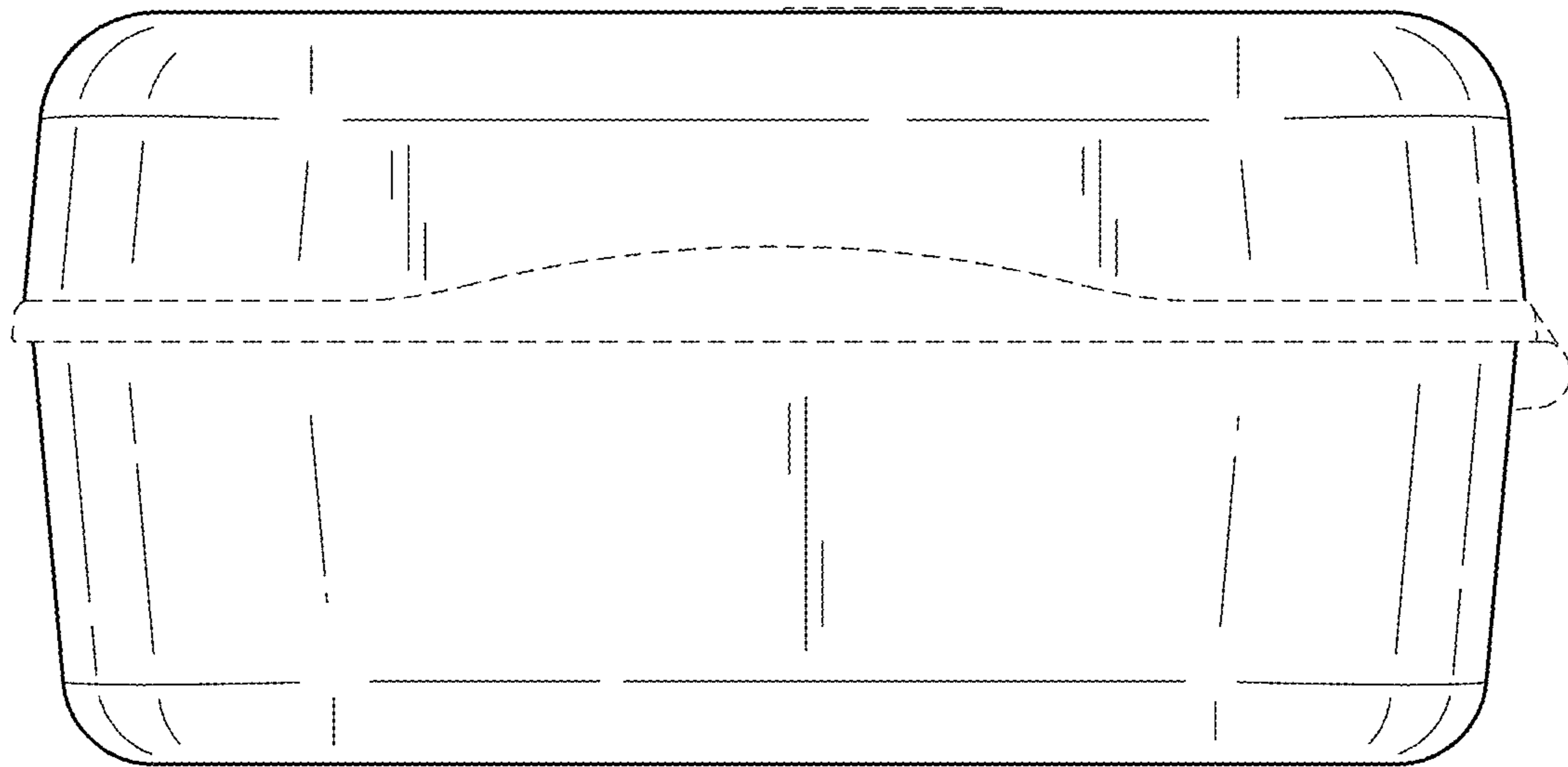

FIG. 6

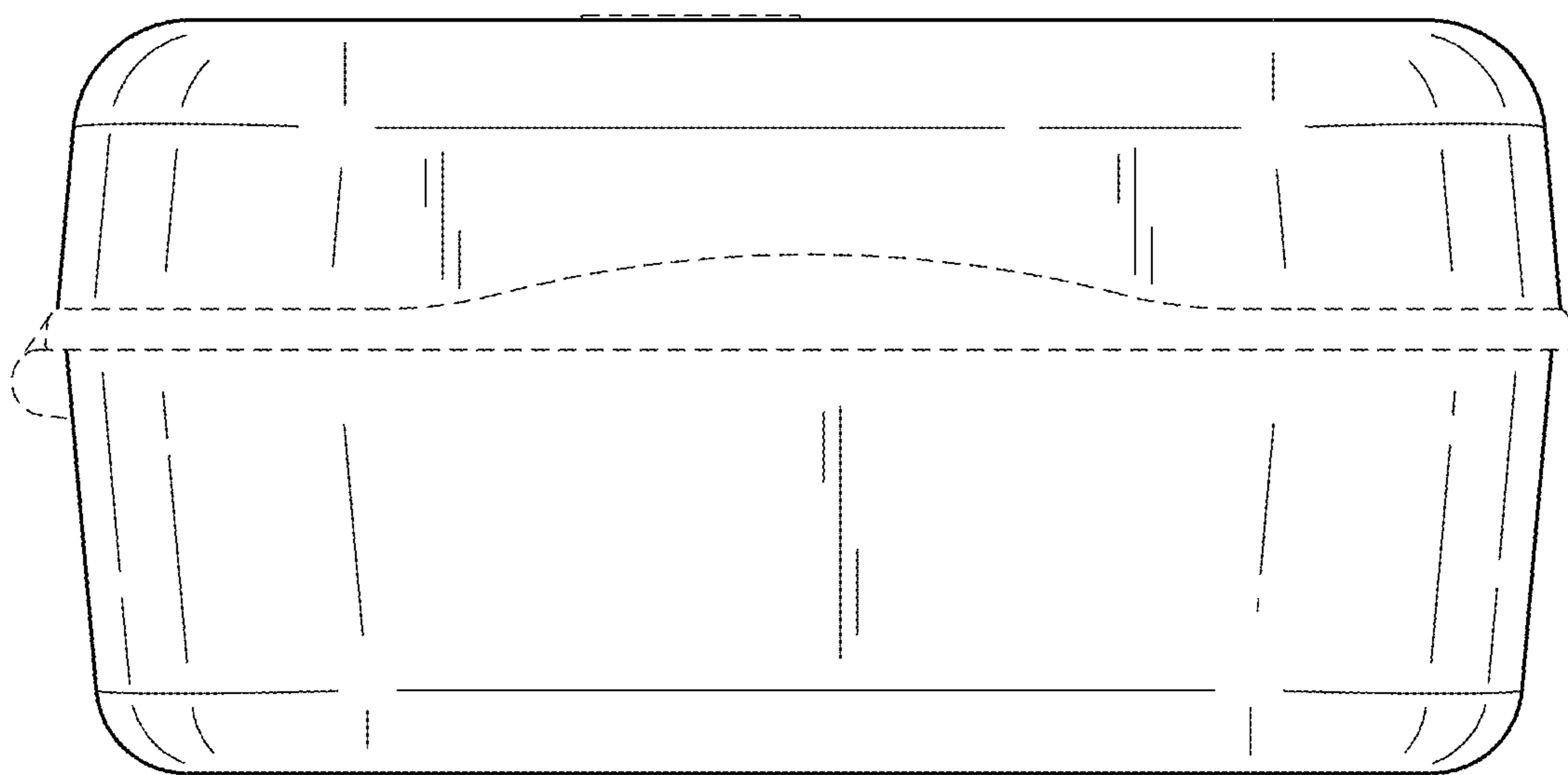

FIG. 7

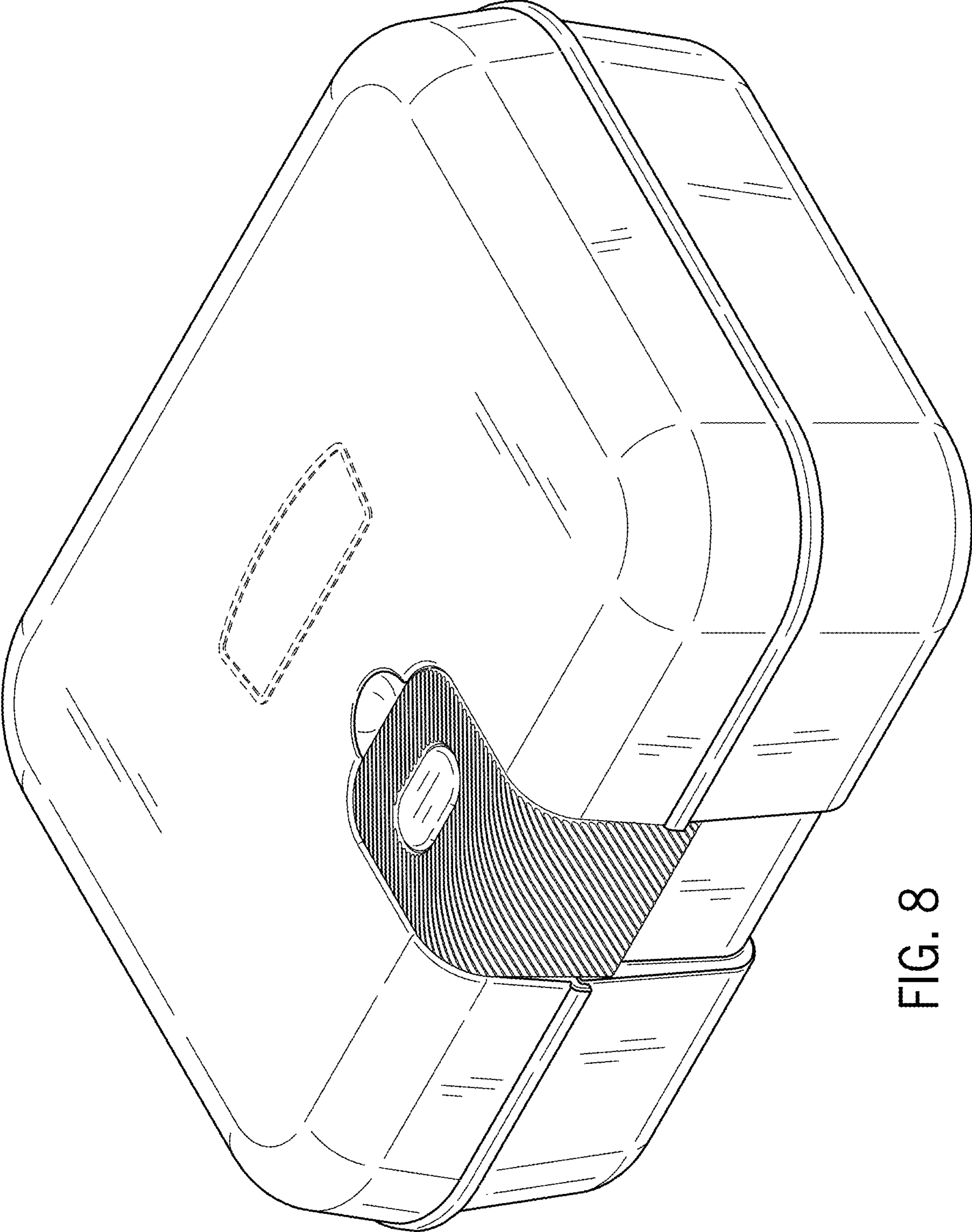

FIG. 8

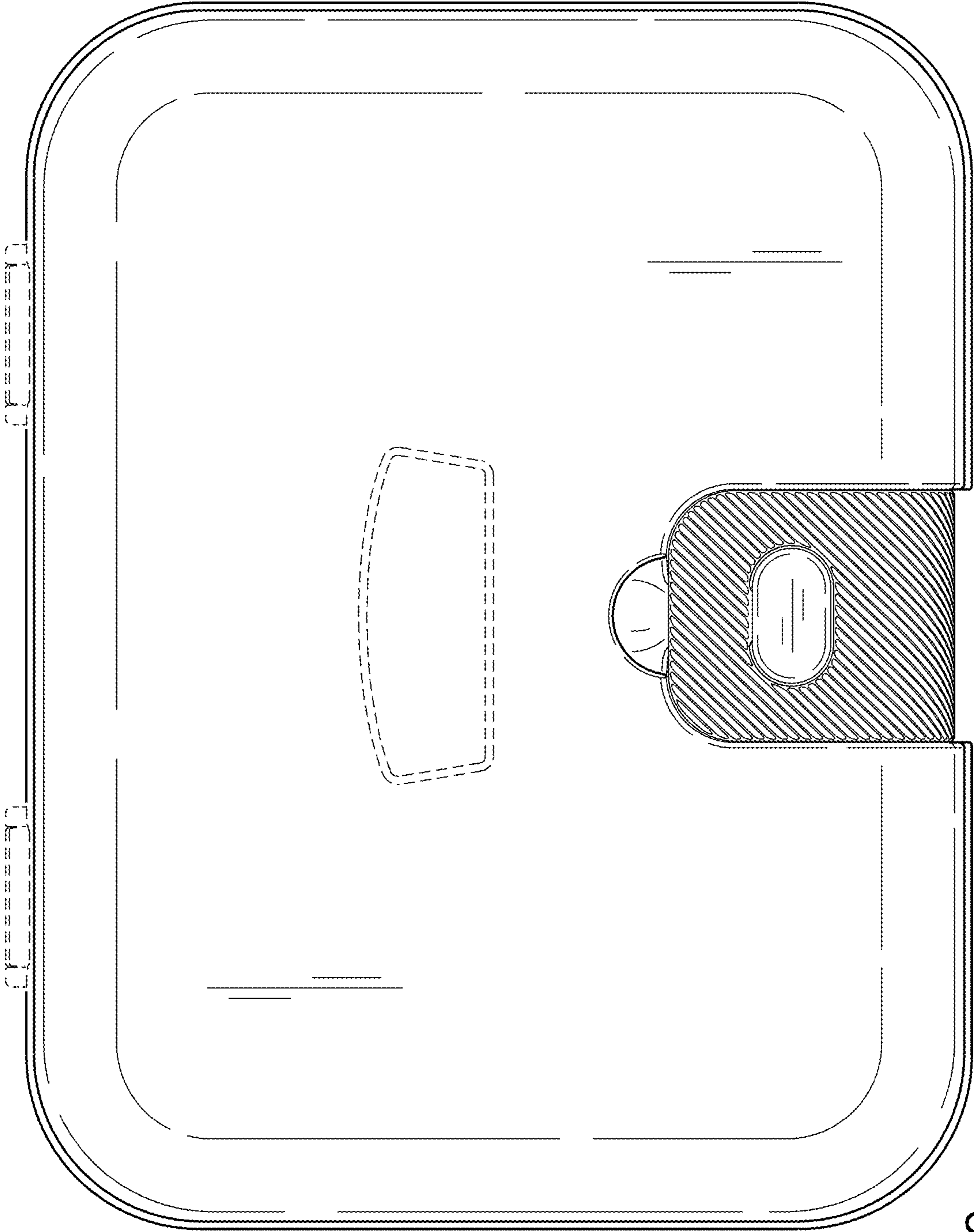

FIG. 9

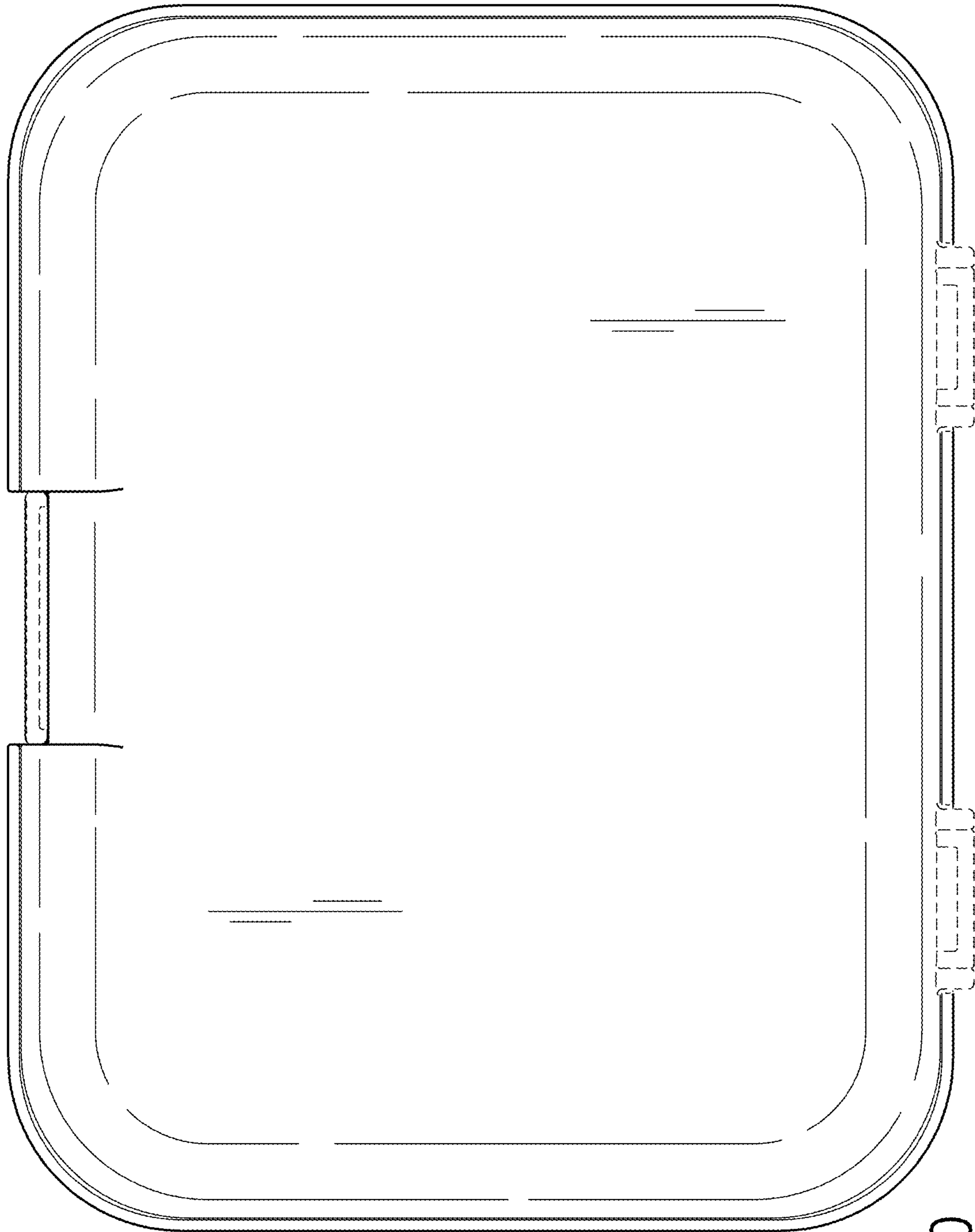

FIG. 10

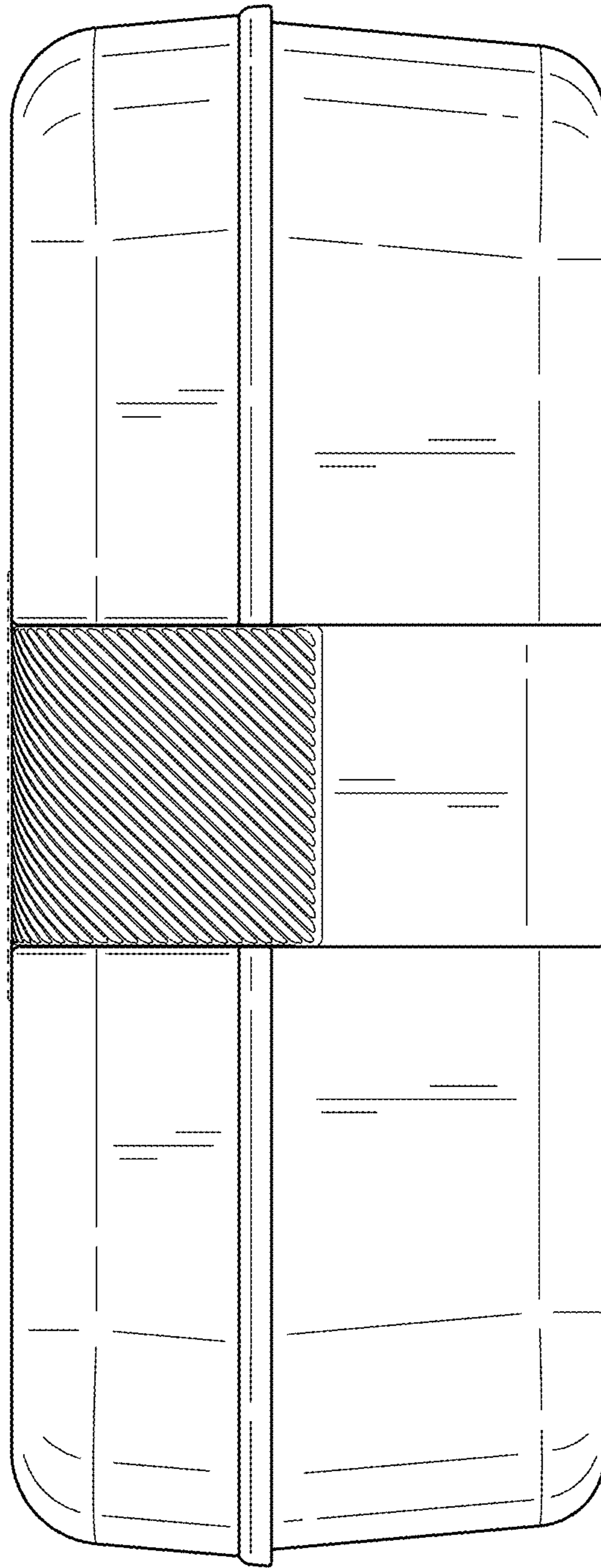

FIG. 11

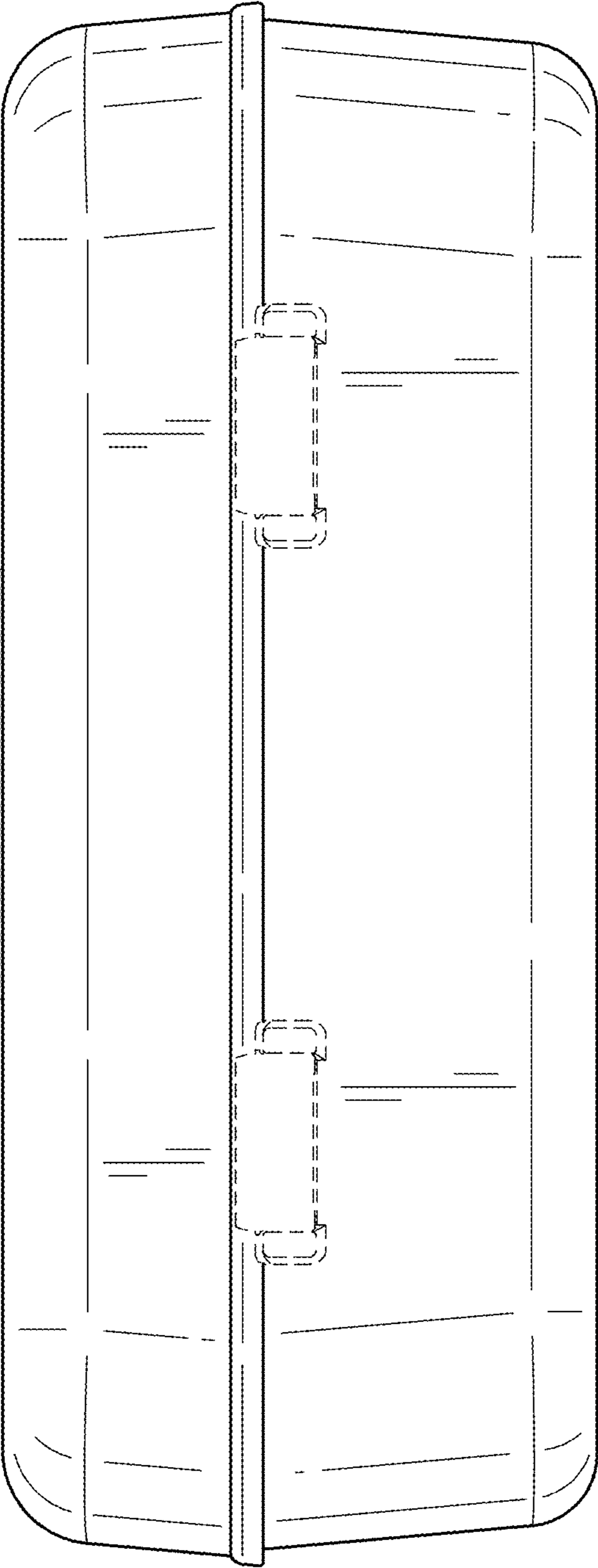

FIG. 12

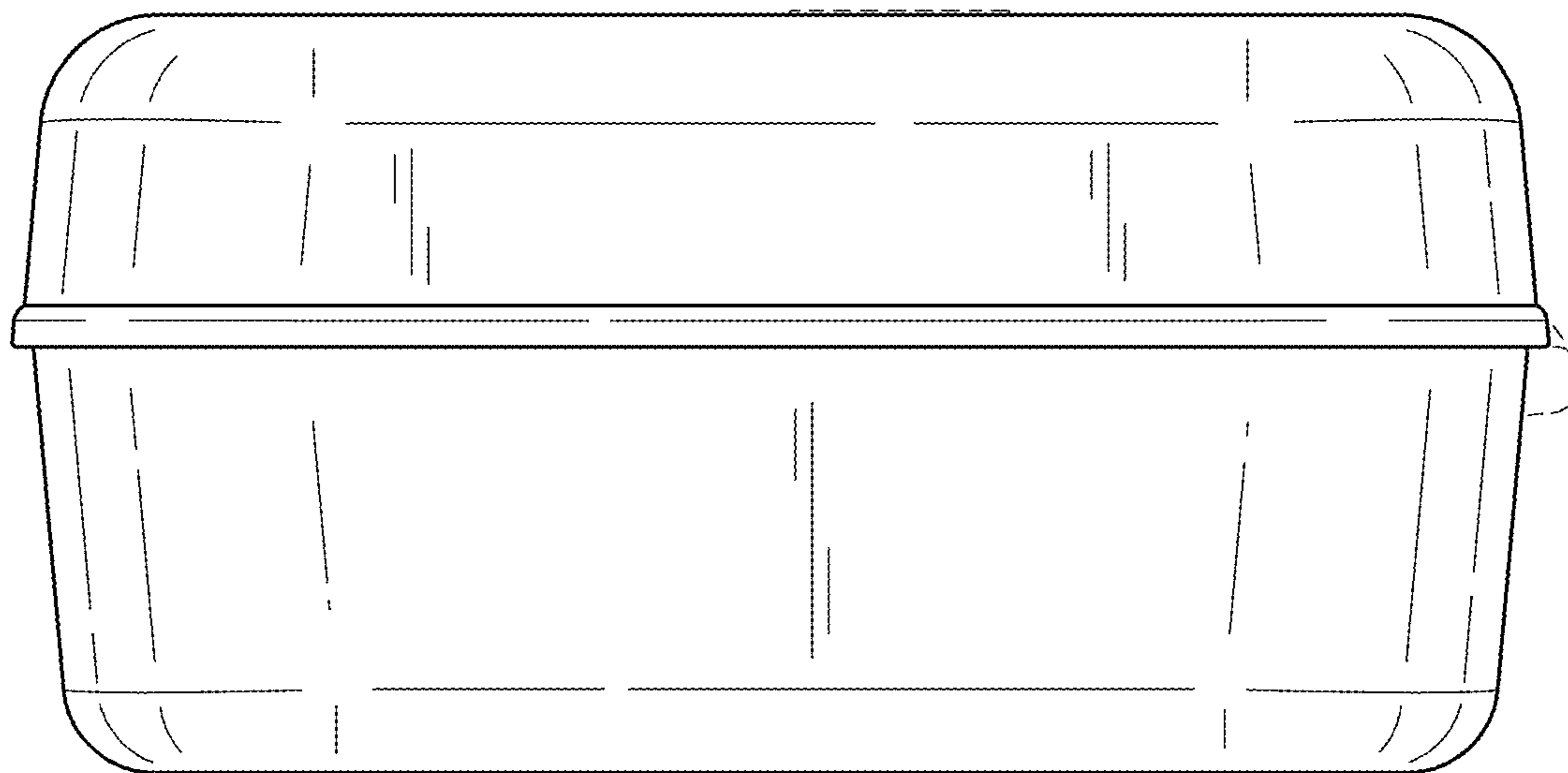

FIG. 13

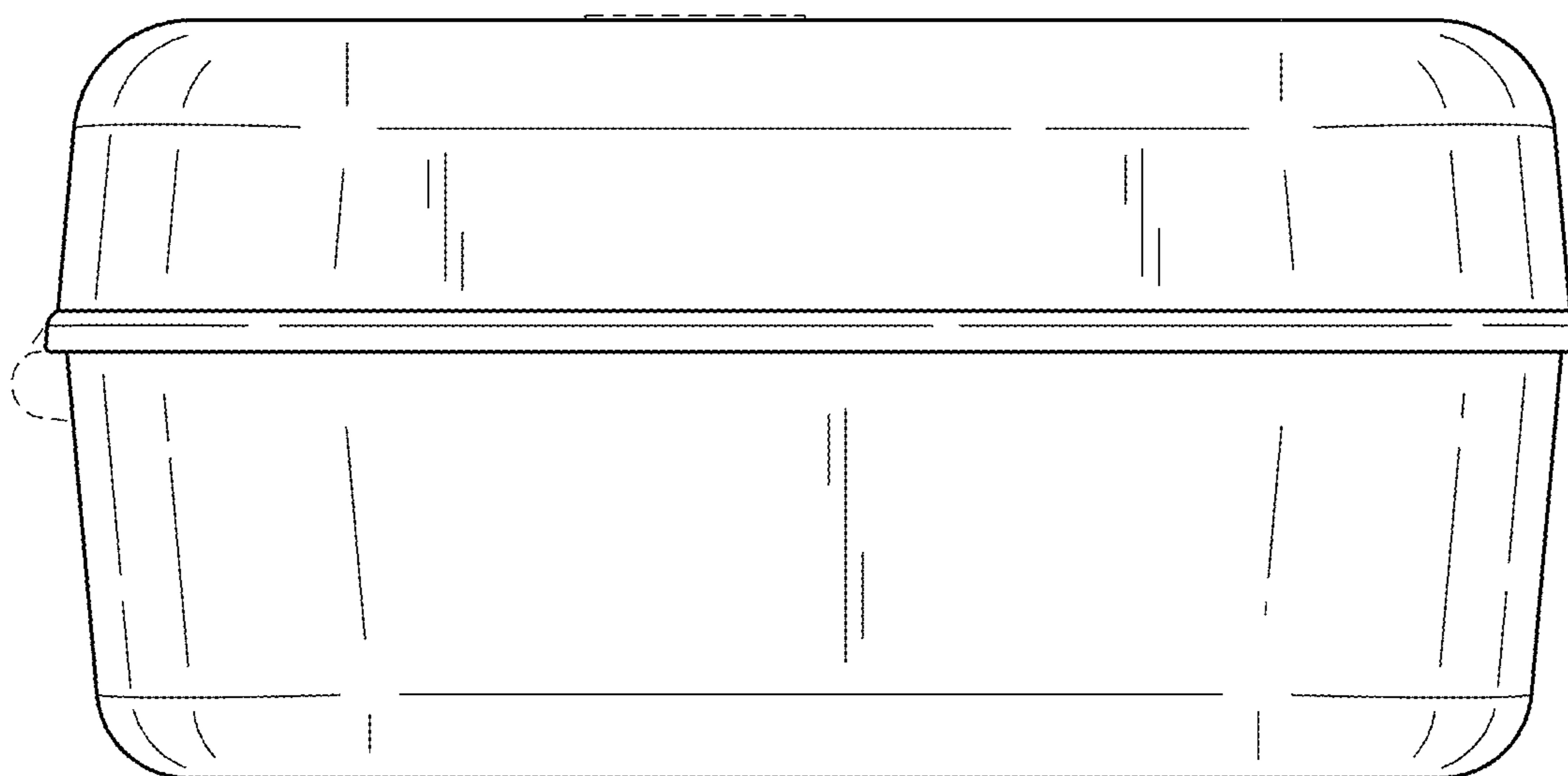

FIG. 14