



US00D912457S

(12) **United States Design Patent**  
**Miller et al.**

(10) **Patent No.:** **US D912,457 S**  
(45) **Date of Patent:** **\*\* Mar. 9, 2021**

(54) **OVEN**  
(71) Applicant: **StoreBound LLC**, New York, NY (US)  
(72) Inventors: **Michael Miller**, Tewkesbury, MA (US);  
**Yiyang Zhang**, Brooklyn, NY (US);  
**Shelby Scott**, New York, NY (US);  
**Evan Marc Dash**, New York, NY (US);  
**Dov Glucksman**, Winchester, MA (US)

D330,144 S \* 10/1992 Takebata ..... D7/351  
D380,643 S \* 7/1997 Piret ..... D7/350.4  
5,957,557 A \* 9/1999 Langer ..... A47B 77/08  
312/223.6  
D525,477 S \* 7/2006 Kim ..... D7/351  
D526,527 S \* 8/2006 Jung ..... D7/348  
D527,572 S \* 9/2006 Lee ..... D7/350.1  
D530,561 S \* 10/2006 Kim ..... D7/351

(Continued)

(73) Assignee: **StoreBound LLC**

(\*\*) Term: **15 Years**

(21) Appl. No.: **29/679,457**

(22) Filed: **Feb. 6, 2019**

(51) **LOC (13) Cl.** ..... **07-02**

(52) **U.S. Cl.**  
USPC ..... **D7/350.1**

(58) **Field of Classification Search**  
USPC ..... D7/323, 330, 331, 334, 338, 339, 340,  
D7/341, 347, 348, 349, 350.1, 350.3,  
D7/350.4, 351, 362, 363, 364, 365, 390,  
D7/402-407; D23/314, 322, 323, 329,  
D23/330, 335, 341; D99/28, 43;  
D15/122, 138, 141, 144, 199; D8/311,  
D8/312, 315, 316, 333, 334; D3/203.1;  
D6/672, 675, 702, 703, 559, 663, 705.5;  
D21/523, 524, 525, 561  
CPC . H05B 6/12; H05B 6/64; H05B 6/806; H05B  
6/6426; H05B 6/6412; A21B 1/52; A21B  
1/00; A47J 37/00; A47J 37/0763; A47J  
37/36; F24C 15/08; F24C 15/2024; F27D  
9/00; F27D 2009/0018; F27D 2009/004;  
F23D 14/02

See application file for complete search history.

(56) **References Cited**

**U.S. PATENT DOCUMENTS**

D260,104 S \* 8/1981 Klawitter ..... D21/524  
D297,296 S \* 8/1988 Feil ..... D7/350.4

**FOREIGN PATENT DOCUMENTS**

EP 004129526-0001 10/2017

**OTHER PUBLICATIONS**

Everyday 23 L Air Fryer Oven: Announced May 3, 2020 [online].  
Site Visited [Jul. 30, 2020]. Available from Internet URL: <https://bydash.com/products/everyday-air-fryer-oven>.\*

(Continued)

*Primary Examiner* — Catherine S Posthauer  
(74) *Attorney, Agent, or Firm* — Belles Katz LLC

(57) **CLAIM**

The ornamental design for an oven, as shown and described.

**DESCRIPTION**

FIG. 1 is a top front perspective view of an oven according to the new design;  
FIG. 2 is a bottom rear perspective view thereof;  
FIG. 3 is a front view thereof;  
FIG. 4 is a rear view thereof;  
FIG. 5 is a left side view thereof;  
FIG. 6 is a right side view thereof;  
FIG. 7 is a top view thereof; and,  
FIG. 8 is a bottom view thereof.  
The broken lines represent portions of the oven that form no part of the claimed design.

**1 Claim, 8 Drawing Sheets**

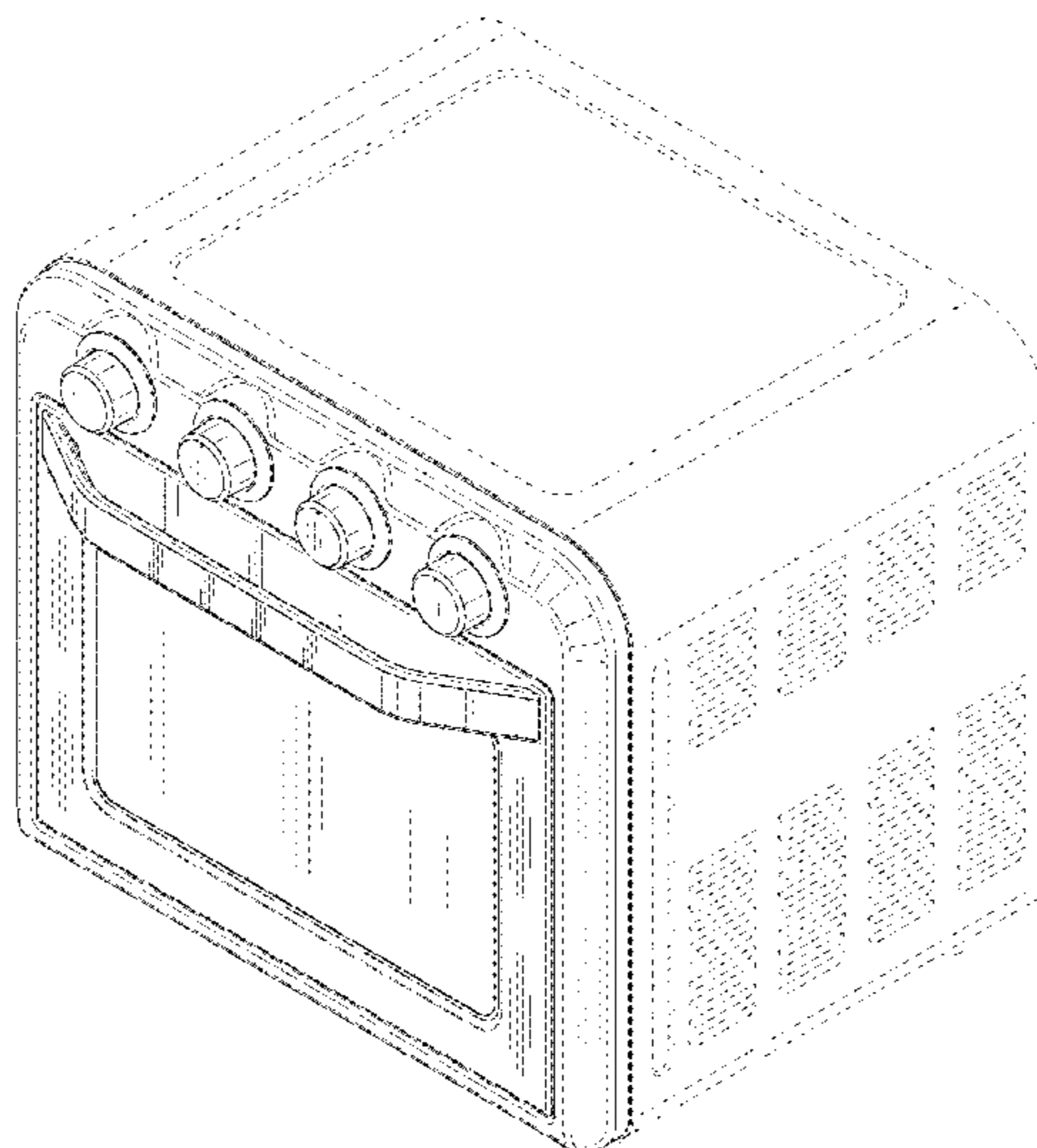

(56)

## References Cited

## U.S. PATENT DOCUMENTS

D533,390 S 12/2006 Ball  
D535,141 S \* 1/2007 Lee ..... D7/351  
D539,593 S \* 4/2007 Wang ..... D7/350.4  
D541,578 S \* 5/2007 Jeon ..... D7/350.1  
D580,698 S \* 11/2008 Kim ..... D7/348  
D610,863 S 3/2010 Kim et al.  
D621,202 S 8/2010 Pino et al.  
D639,104 S 6/2011 Duncan et al.  
D646,112 S \* 10/2011 Park ..... D7/348  
D646,113 S \* 10/2011 Park ..... D7/348  
D655,970 S \* 3/2012 De' Longhi ..... D7/351  
D664,388 S \* 7/2012 Park ..... D7/348  
D670,529 S \* 11/2012 Hensel ..... D7/350.1  
D673,000 S \* 12/2012 De' Longhi ..... D7/350.1  
D678,711 S \* 3/2013 Reiner ..... D7/350.1  
D708,005 S 7/2014 Kurt  
D762,081 S \* 7/2016 Minvielle ..... D7/350.1  
D781,635 S 3/2017 Koszylko  
D782,864 S \* 4/2017 Bhogal ..... D7/350.1  
D783,336 S 4/2017 Suh et al.  
9,756,981 B2 9/2017 Fung  
D815,485 S \* 4/2018 Suehiro ..... D7/350.1  
D848,197 S \* 5/2019 Wong ..... D7/350.4  
2015/0040774 A1 2/2015 Fung  
2016/0033141 A1 2/2016 Rizzuto

## OTHER PUBLICATIONS

Greek Chef Air Fryer: Announced Sep. 12, 2020. Available from Internet URL: [https://www.amazon.com/Geek-Chef-Convection-Countertop-Accessories/dp/B08HQXMLRB/ref=cm\\_cr\\_ar\\_p\\_d\\_product\\_top?ie=UTF8](https://www.amazon.com/Geek-Chef-Convection-Countertop-Accessories/dp/B08HQXMLRB/ref=cm_cr_ar_p_d_product_top?ie=UTF8).\*

Chef Series Air Fryer Oven by Dash: Site Visited [Nov. 6, 2020]. Available from Internet URL: <https://bydash.com/products/chef-series-air-fryer-oven-231?variant=32067055288374>.\*

DAWAD Air Fryer: Announced Oct. 28, 2020 [online]. Site Visited [Nov. 6, 2020]. Available from Internet URL: <https://www.amazon.com/dp/B08GP28VXT#customerReviews>.\*

Farberware Air Fryer Toaster Oven—No Oil, No Splatter, No Mess. Internet at: [walmart.com/ip/Farberware-Air-Fryer-Toaster-Oven/718543483](https://walmart.com/ip/Farberware-Air-Fryer-Toaster-Oven/718543483).

Oster Countertop Oven with Air Fryer. Internet at: <https://www.oster.com/kitchen-appliances/air-fryers/oster-countertop-oven-with-air-fryer-black/31161173.html>. Printed Feb. 6, 2019. US.

Oster Designed For Life Extra-Large Convection Countertop Oven (TSSTTVXLDG-002). Internet at: <https://www.walmart.com/ip/Oster-Designed-For-Life-Extra-Large-Convection-Countertop-Oven-TSSTTVXLDG-002/13729291>. Printed Feb. 6, 2019. US.

\* cited by examiner

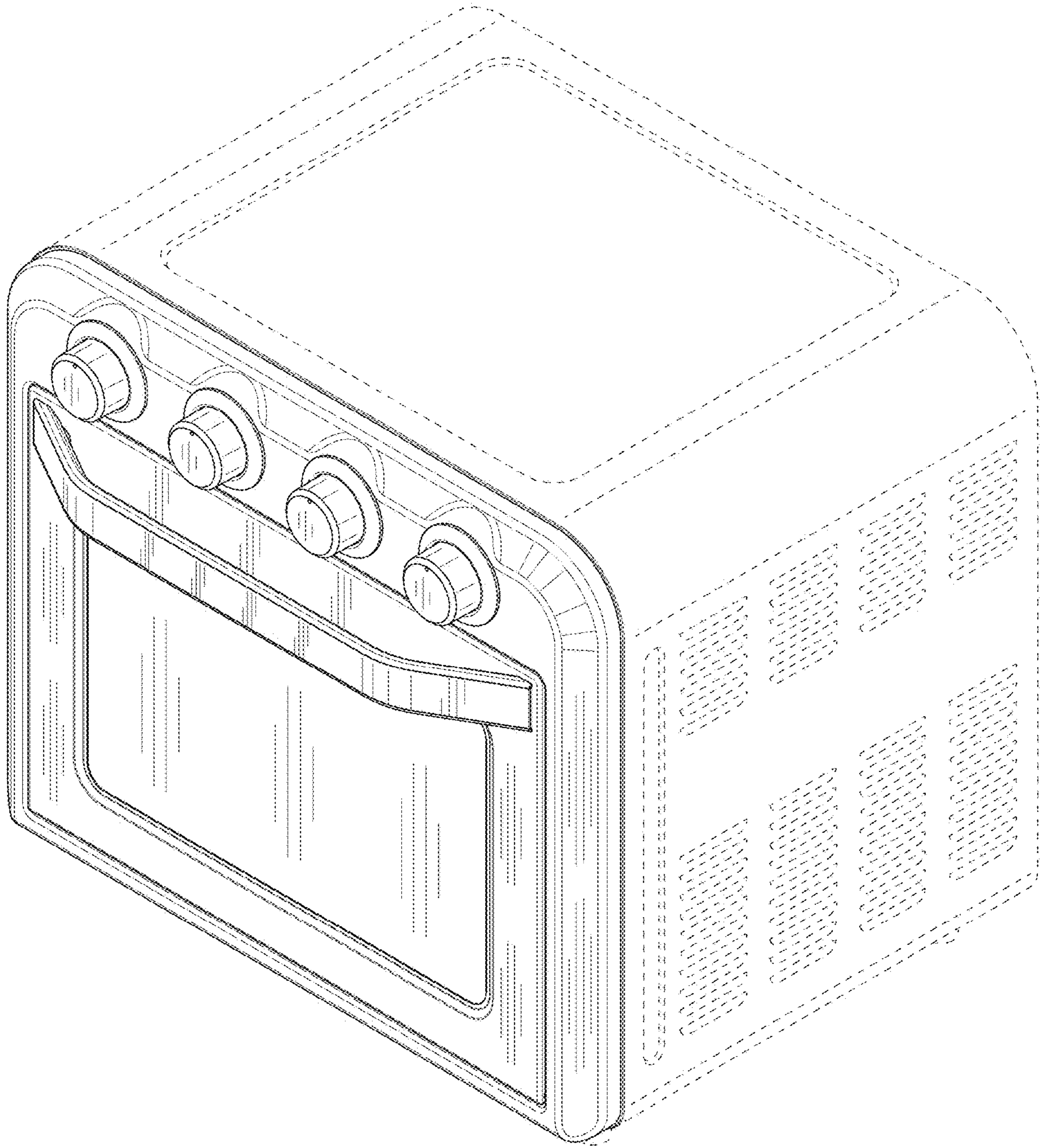

FIG. 1

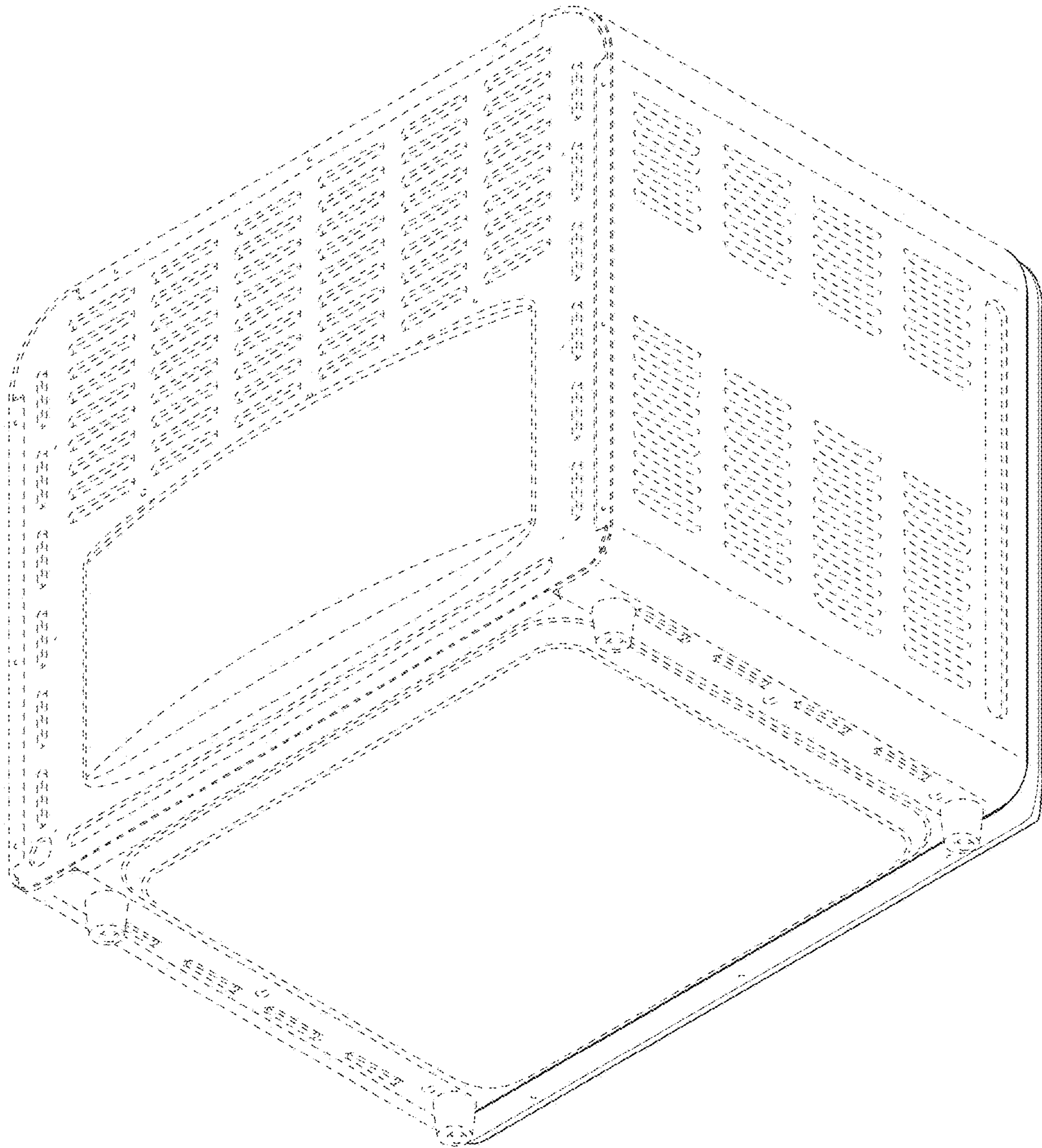

FIG. 2

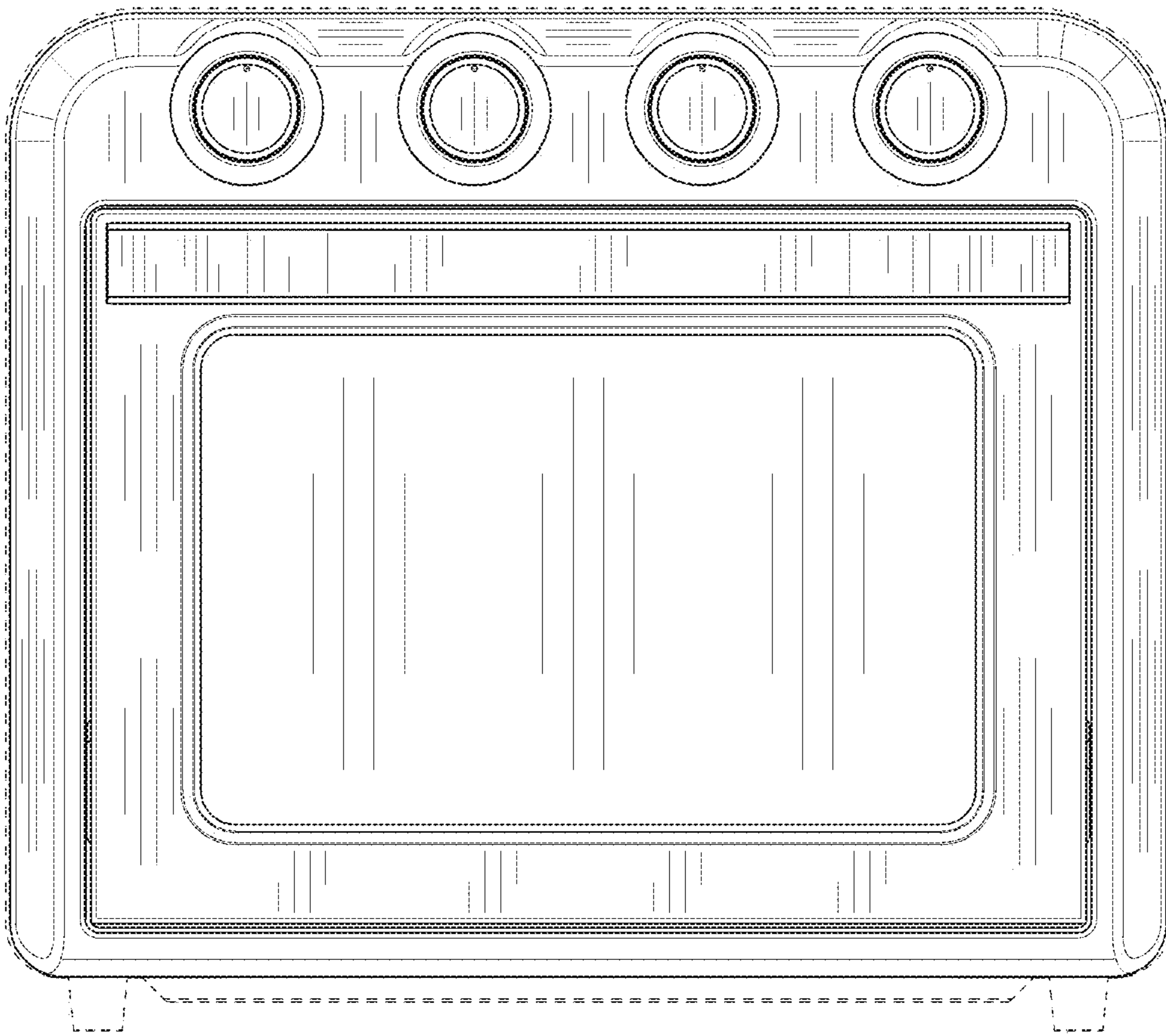

FIG. 3

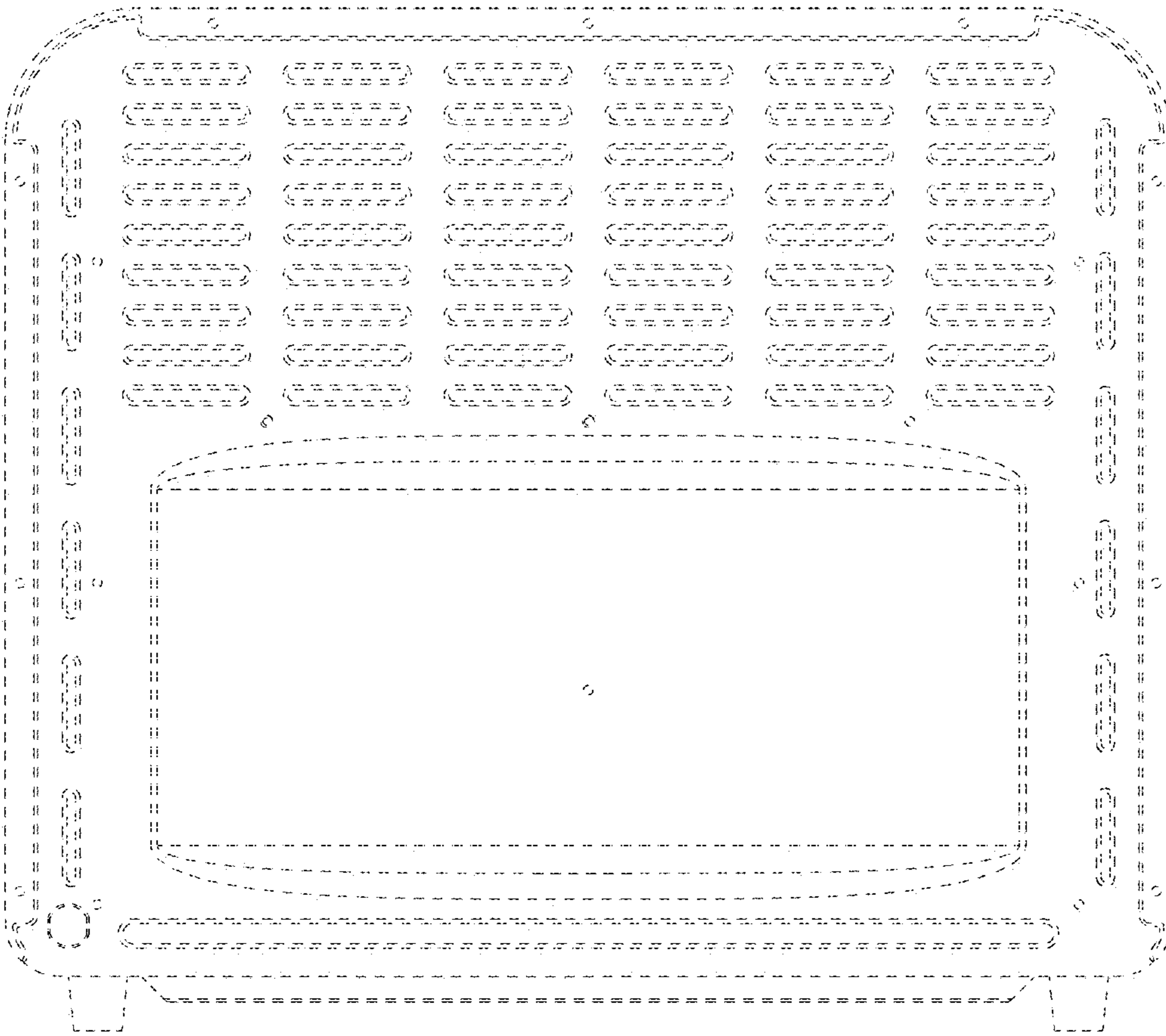

FIG. 4

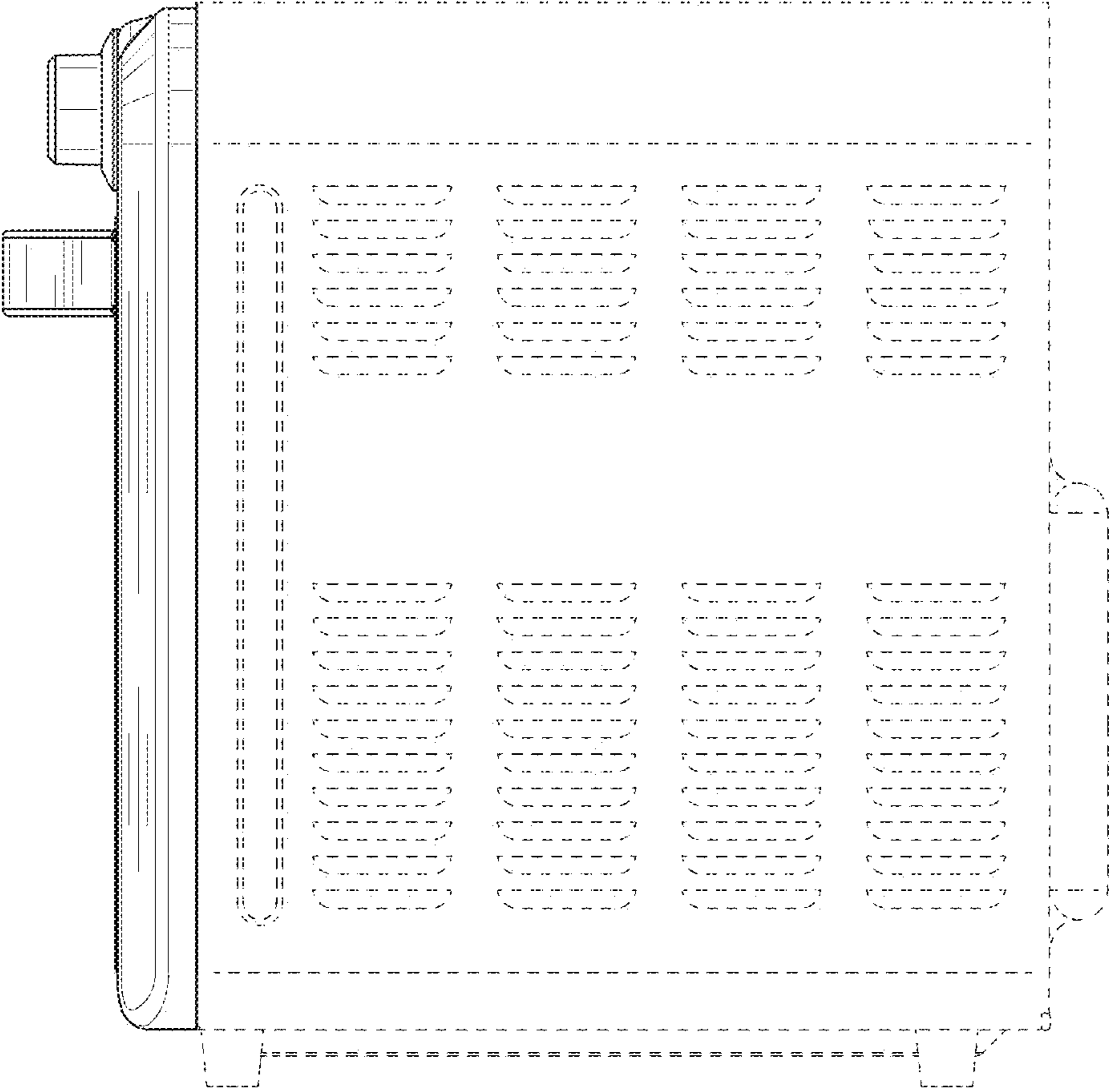

FIG. 5

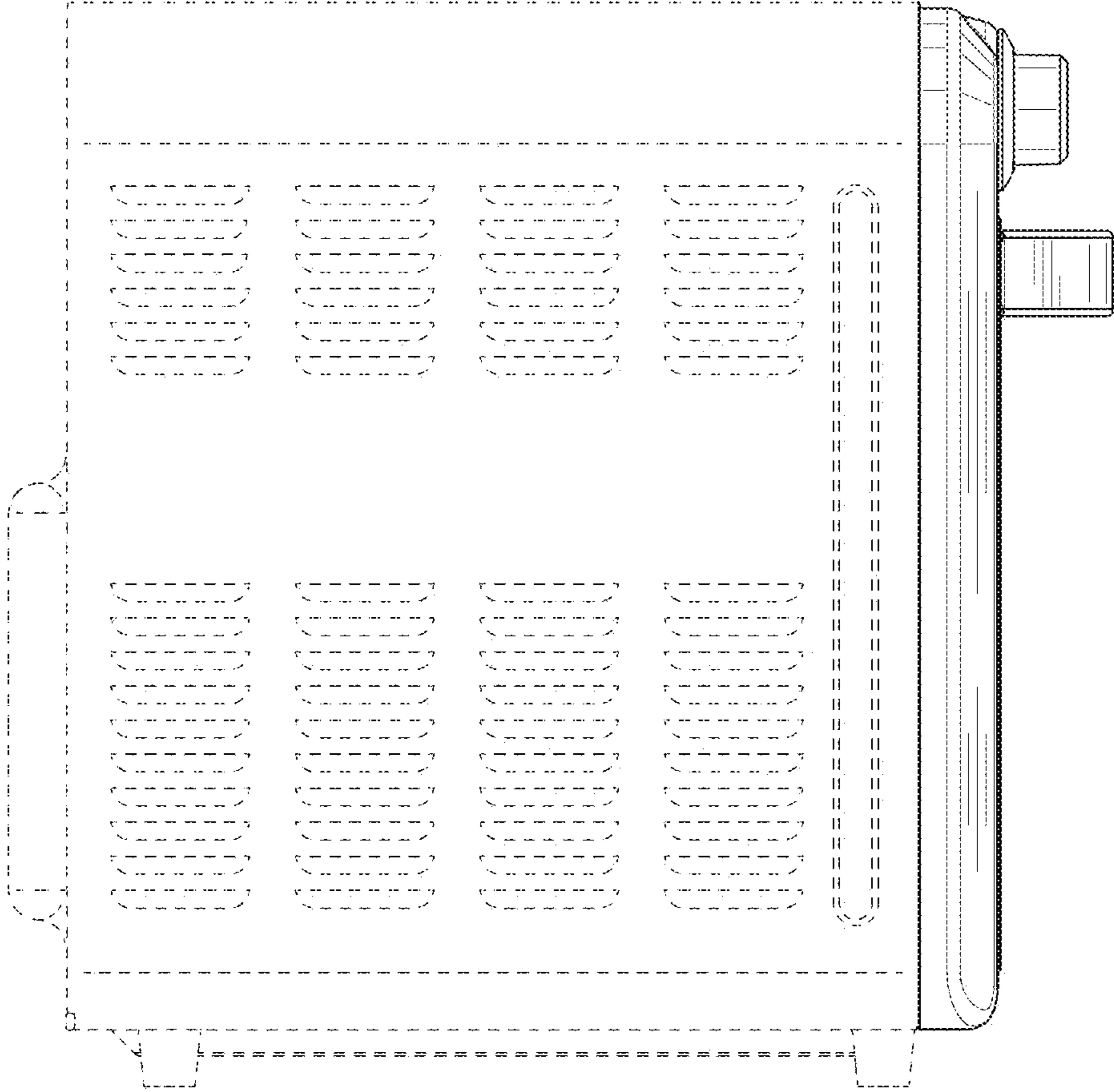

FIG. 6



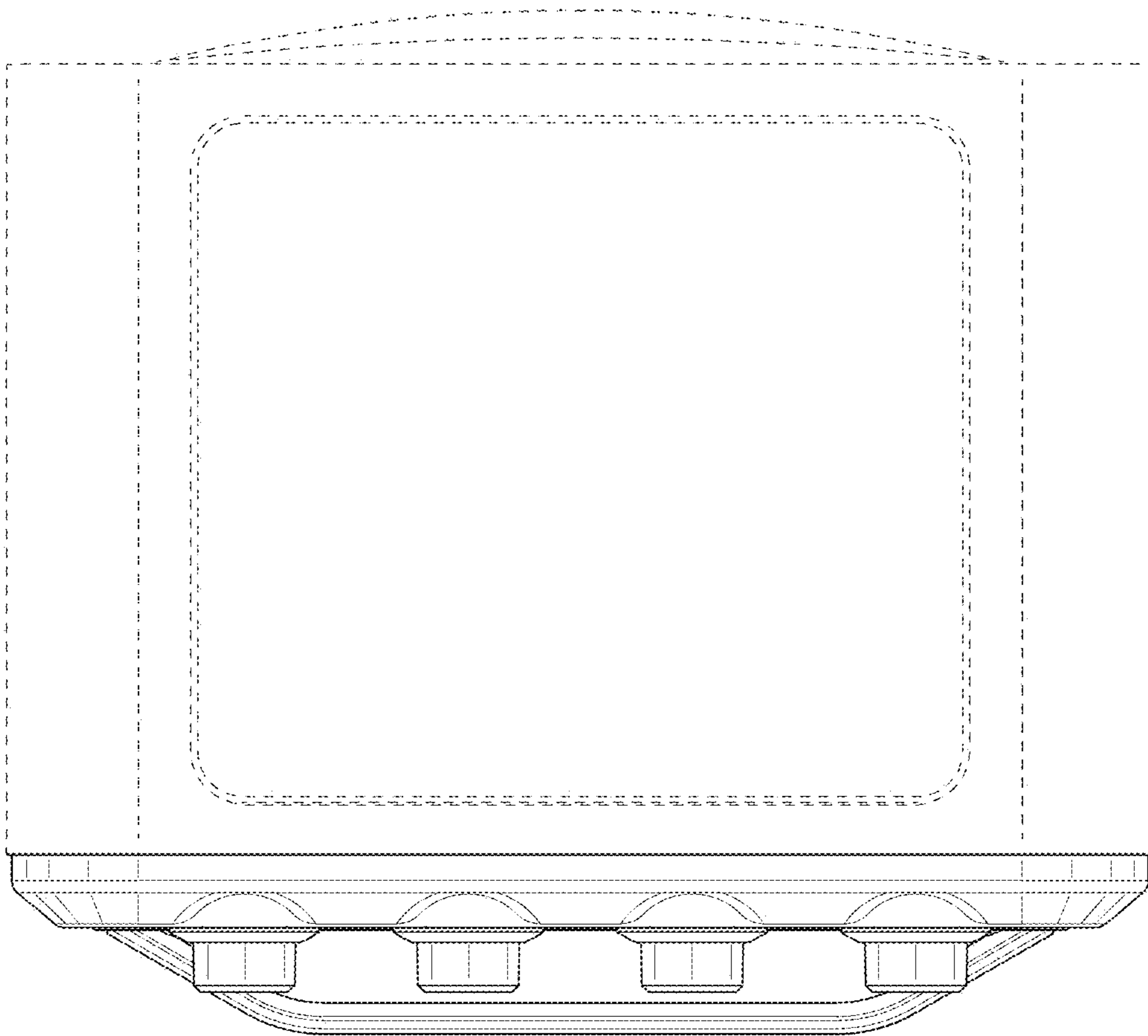

FIG. 7

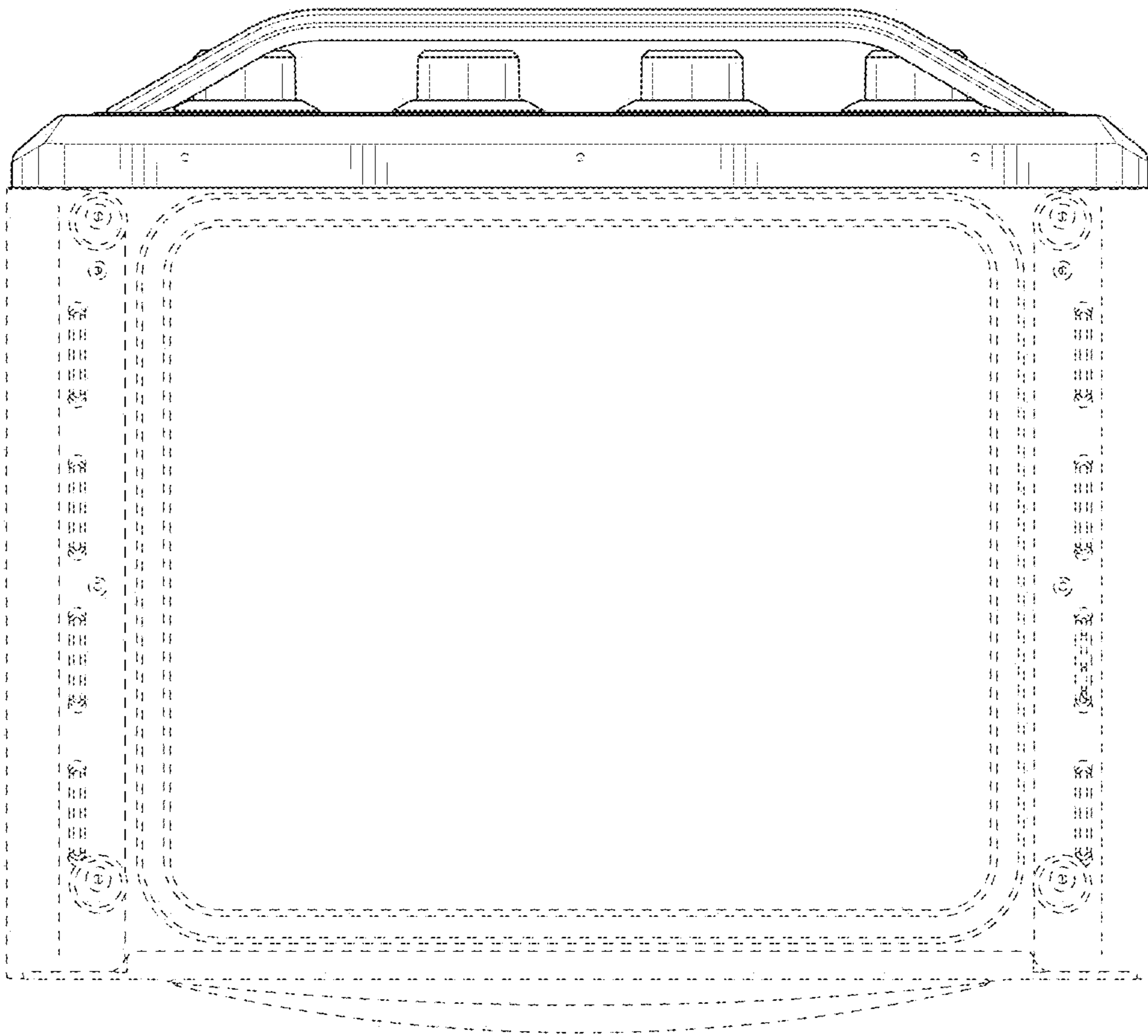

FIG. 8