

US00D912454S

(12) **United States Design Patent**  
**Kazanowski et al.**

(10) **Patent No.:** **US D912,454 S**  
(45) **Date of Patent:** **\*\* Mar. 9, 2021**

- (54) **WINE BAG** D517,797 S \* 3/2006 Lown ..... B65D 33/08  
D3/202
- (71) Applicants: **Michael Kazanowski**, Bingham Farms, MI (US); **Adam Kazanowski**, Bingham Farms, MI (US) D518,631 S \* 4/2006 Lown ..... B65D 33/08  
D3/202
- (72) Inventors: **Michael Kazanowski**, Bingham Farms, MI (US); **Adam Kazanowski**, Bingham Farms, MI (US) D520,229 S \* 5/2006 Lown ..... B65D 33/08  
D3/202
- (\*\*) Term: **15 Years** D529,278 S \* 10/2006 Swartz ..... B65D 33/08  
D3/202
- (21) Appl. No.: **29/736,704** D529,709 S \* 10/2006 Swartz ..... B65D 33/08  
D3/202
- (22) Filed: **Jun. 2, 2020** D547,545 S \* 7/2007 Boehm ..... D3/201  
D555,352 S \* 11/2007 Lown ..... D3/202  
D560,351 S \* 1/2008 Boehm ..... D3/201  
D564,215 S \* 3/2008 Swartz ..... D3/202  
D570,594 S \* 6/2008 Litvak ..... D3/202  
D575,120 S \* 8/2008 Tagliati ..... D3/202

(Continued)

**Related U.S. Application Data**

- (63) Continuation of application No. 29/660,790, filed on Aug. 22, 2018, now abandoned.
- (51) **LOC (13) Cl.** ..... **07-01**
- (52) **U.S. Cl.**  
USPC ..... **D7/313; D3/202**
- (58) **Field of Classification Search**  
USPC ..... D3/201, 202, 232, 233, 238, 276, 269,  
D3/273, 303; D7/300, 312, 313, 607,  
D7/619.1; D9/654, 733  
CPC .. A45F 5/10; A45F 2005/1006; A45F 5/1026;  
B65D 5/746; B65D 5/76; B65D 33/08;  
B65D 33/10; B65D 37/00; B65D  
39/0005; B65D 83/0055; B65D 83/50  
See application file for complete search history.

**References Cited**

**U.S. PATENT DOCUMENTS**

- D435,964 S \* 1/2001 Lentz ..... D3/201
- 6,591,874 B2 \* 7/2003 Credle, Jr. .... B65D 75/5877  
141/10
- 6,883,683 B1 \* 4/2005 Cunningham ..... B65D 77/065  
222/107

*Primary Examiner* — Steven J Czyz

(74) *Attorney, Agent, or Firm* — Mitchell Law PLLC;  
Matthew W. Mitchell

(57) **CLAIM**

We claim the ornamental design for the wine bag, as shown and described.

**DESCRIPTION**

FIG. 1 is a front view of a wine bag, in accordance with the present design;  
 FIG. 2 is a right view thereof;  
 FIG. 3 is a left view thereof;  
 FIG. 4 is a rear view thereof;  
 FIG. 5 is an enlarged perspective view of the handle portion;  
 FIG. 6 is a bottom view of the wine bag;  
 FIG. 7 is a top view thereof; and  
 FIG. 8 is a right view, shown in use with wine in the bag for ease of disclosure; and,  
 FIG. 9 is an enlarged perspective view of the dispensing element of the wine bag.  
 The broken lines depict portions of the article and environment that forms no part of the claimed design.

**1 Claim, 6 Drawing Sheets**

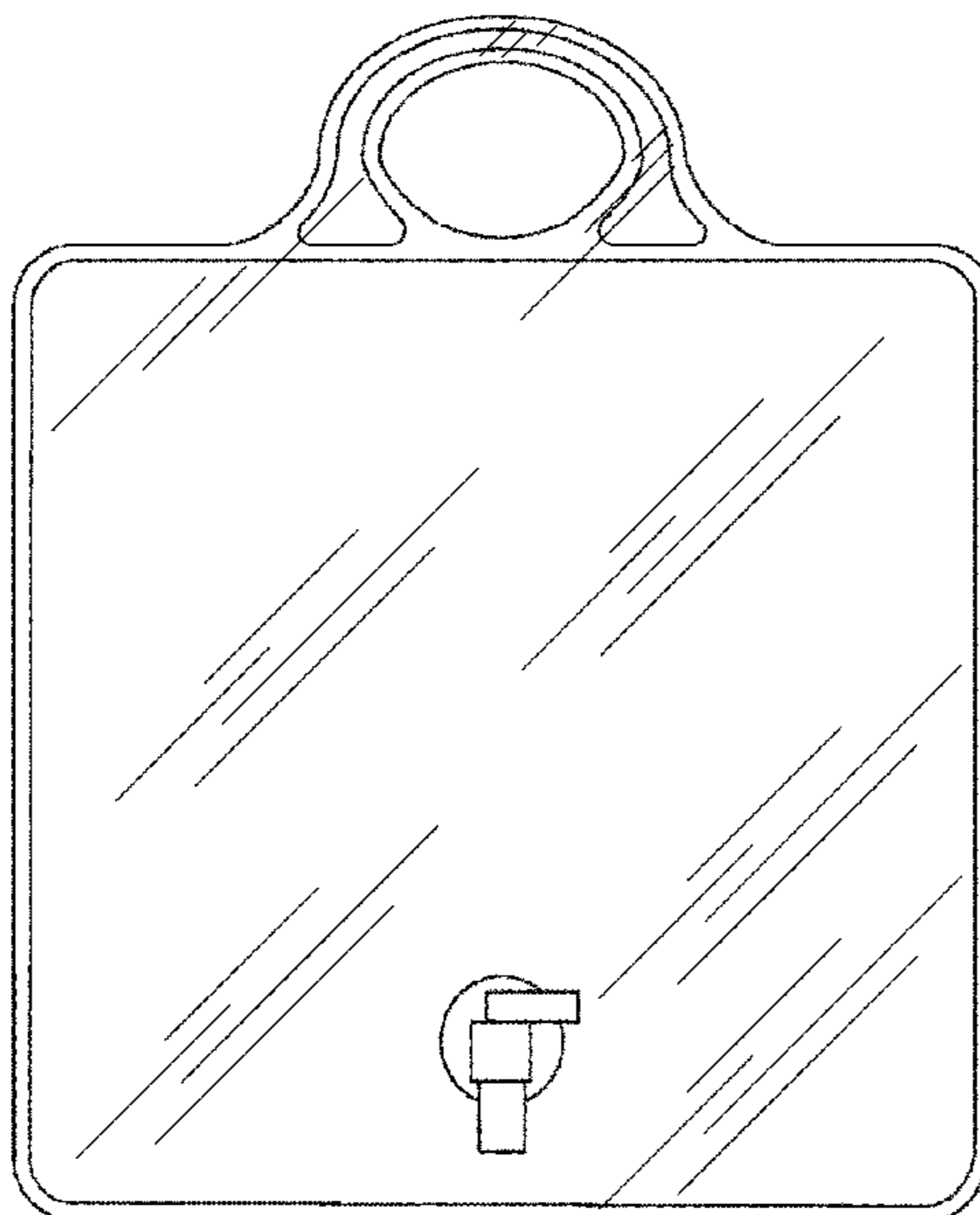

(56)

References Cited

U.S. PATENT DOCUMENTS

|                |         |             |       |             |                   |         |             |       |              |
|----------------|---------|-------------|-------|-------------|-------------------|---------|-------------|-------|--------------|
| D585,705 S *   | 2/2009  | Weers       | ..... | D7/607      | D806,476 S *      | 1/2018  | Karl, IV    | ..... | D7/509       |
| D591,508 S *   | 5/2009  | Lown        | ..... | D3/201      | D808,819 S *      | 1/2018  | Gillman     | ..... | D9/702       |
| D592,912 S *   | 5/2009  | Lown        | ..... | D3/232      | D811,823 S *      | 3/2018  | Kandel      | ..... | D7/607       |
| D606,745 S *   | 12/2009 | Walton      | ..... | D3/234      | D821,225 S *      | 6/2018  | Andochick   | ..... | D9/707       |
| D619,861 S *   | 7/2010  | Swartz      | ..... | D7/709      | 10,035,318 B2 *   | 7/2018  | Berger      | ..... | B65D 33/02   |
| D677,101 S *   | 3/2013  | Mullins     | ..... | D7/306      | D830,850 S *      | 10/2018 | Tan         | ..... | B65D 31/10   |
| D690,501 S *   | 10/2013 | Yetts       | ..... | D3/202      |                   |         |             |       | D9/709       |
| D692,774 S *   | 11/2013 | Cheng       | ..... | D9/704      | 10,173,813 B2 *   | 1/2019  | Ma          | ..... | B65D 47/063  |
| D693,566 S *   | 11/2013 | Martin      | ..... | D3/202      | D856,821 S *      | 8/2019  | Sahatjian   | ..... | D9/708       |
| D693,567 S *   | 11/2013 | Martin      | ..... | D3/202      | 10,421,584 B2 *   | 9/2019  | Ross        | ..... | B65D 33/08   |
| D695,568 S *   | 12/2013 | Hayes       | ..... | D7/392      | 2002/0190080 A1 * | 12/2002 | Credle, Jr. | ..... | B65D 75/5877 |
| D708,836 S *   | 7/2014  | Lee         | ..... | D3/201      |                   |         |             |       | 222/105      |
| D711,178 S *   | 8/2014  | Waugh       | ..... | D7/306      | 2008/0247684 A1 * | 10/2008 | Binks       | ..... | B65D 49/02   |
| D734,940 S *   | 7/2015  | Fay         | ..... | D3/202      |                   |         |             |       | 383/113      |
| 9,266,647 B2 * | 2/2016  | Grossman    | ..... | B65D 31/00  | 2011/0210143 A1 * | 9/2011  | Jones       | ..... | B01F 13/00   |
| D751,848 S *   | 3/2016  | Price       | ..... | D7/301      |                   |         |             |       | 222/1        |
| D755,502 S *   | 5/2016  | Halter      | ..... | D3/202      | 2012/0255971 A1 * | 10/2012 | Griffith    | ..... | A45F 3/02    |
| 9,346,589 B2 * | 5/2016  | Bunton      | ..... | B65D 77/225 |                   |         |             |       | 222/105      |
| D771,940 S *   | 11/2016 | Wei         | ..... | D3/232      | 2013/0206800 A1 * | 8/2013  | Simonsen    | ..... | A45C 7/0022  |
| D786,090 S *   | 5/2017  | Murray      | ..... | D9/707      |                   |         |             |       | 224/148.3    |
| 9,650,178 B2 * | 5/2017  | Maglio, Jr. | ..... | B65D 33/004 | 2017/0158380 A1 * | 6/2017  | Ross        | ..... | B65D 33/08   |
|                |         |             |       |             | 2017/0233142 A1 * | 8/2017  | Han         | ..... | B65D 33/08   |
|                |         |             |       |             |                   |         |             |       | 383/10       |

\* cited by examiner

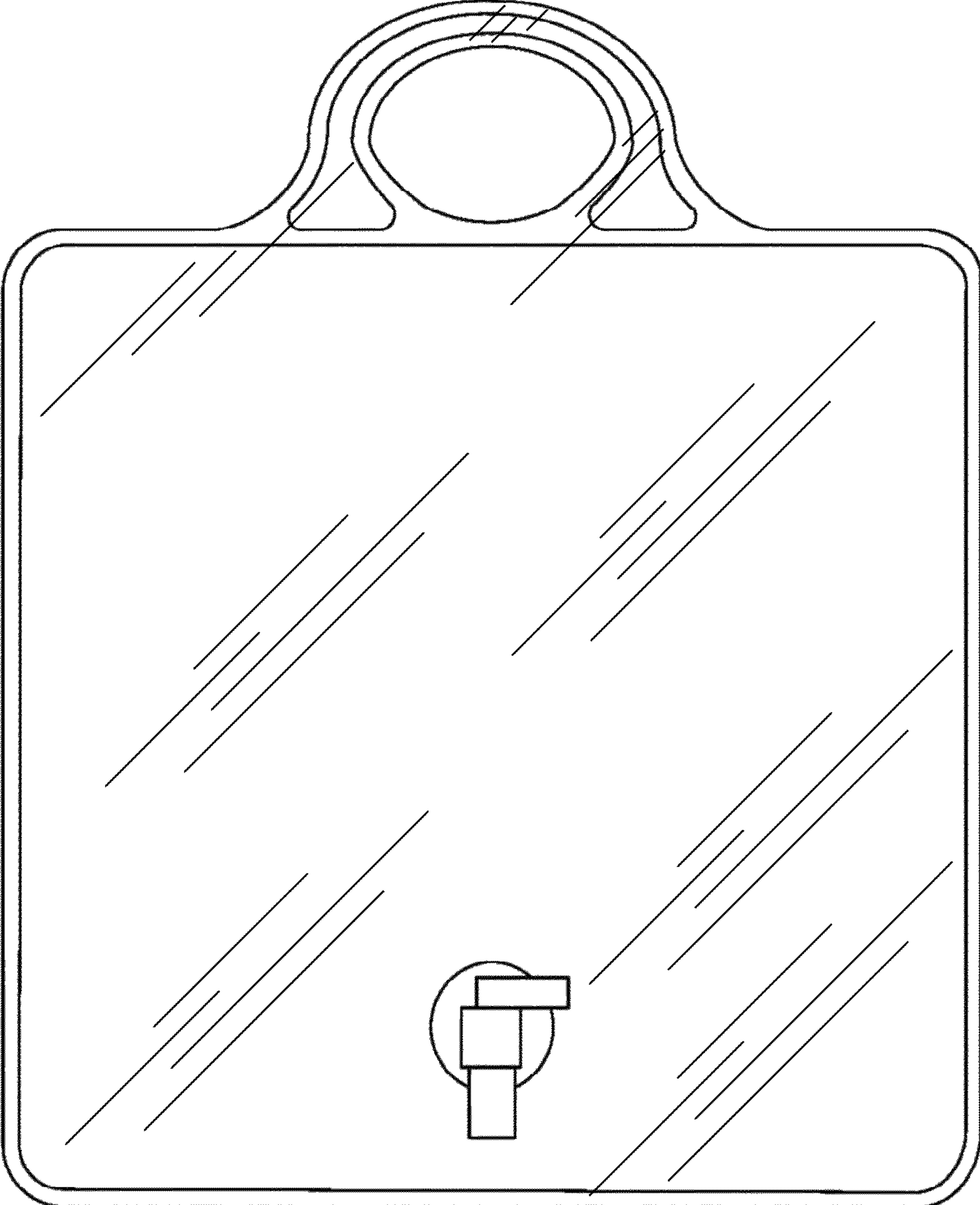

FIG. 1



FIG. 2

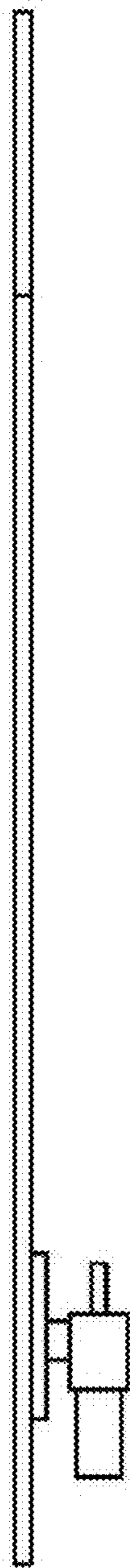

FIG. 3

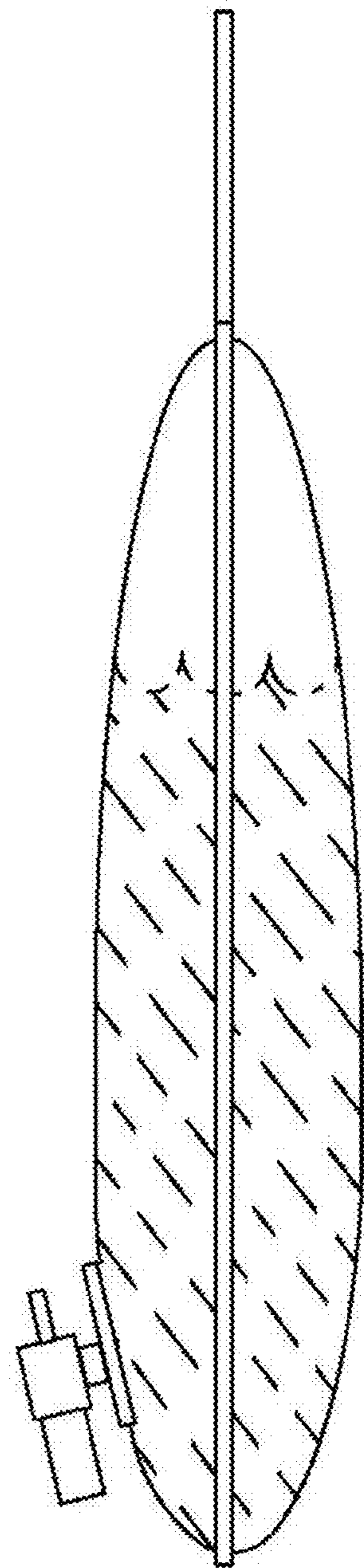

FIG. 8

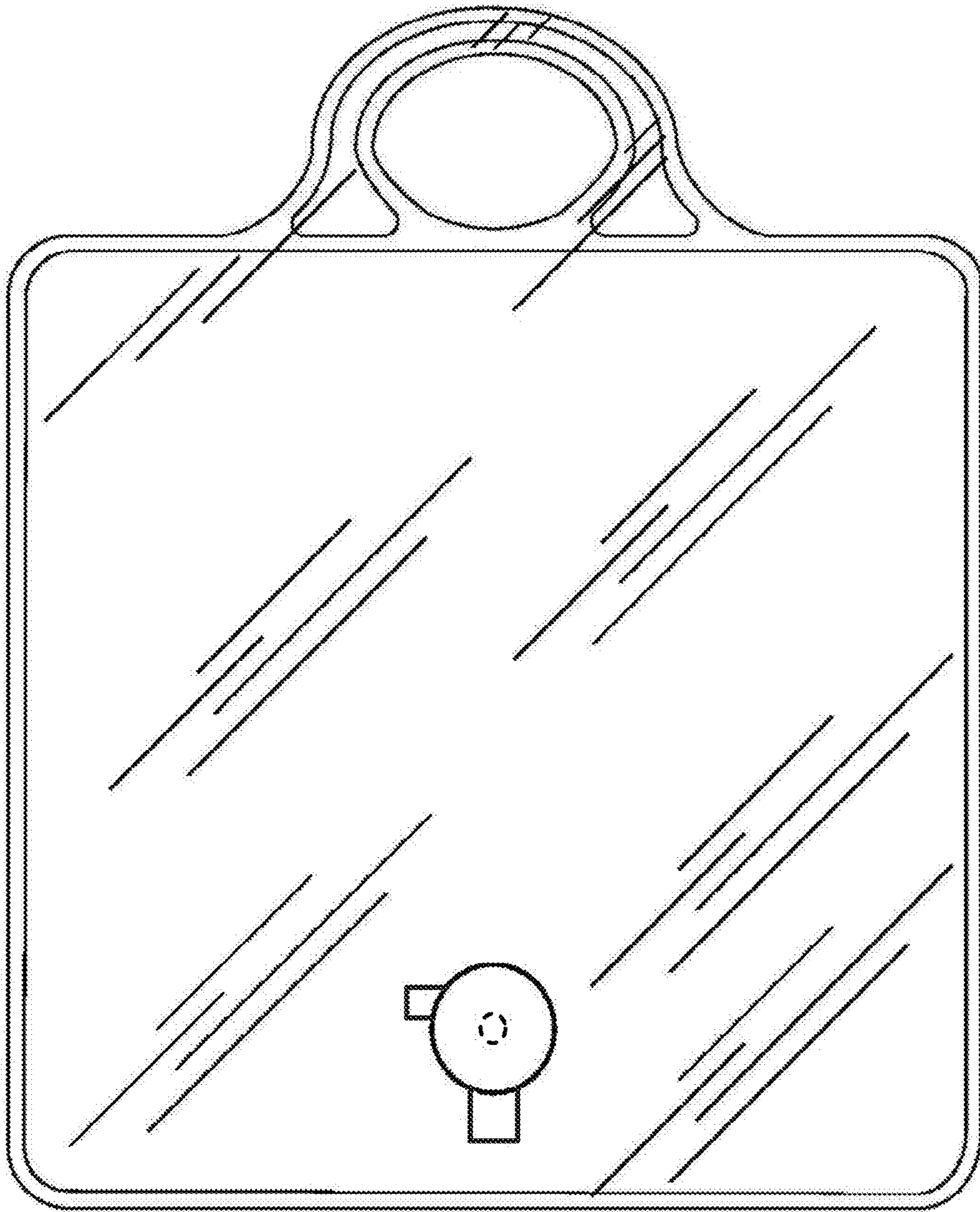

FIG. 4

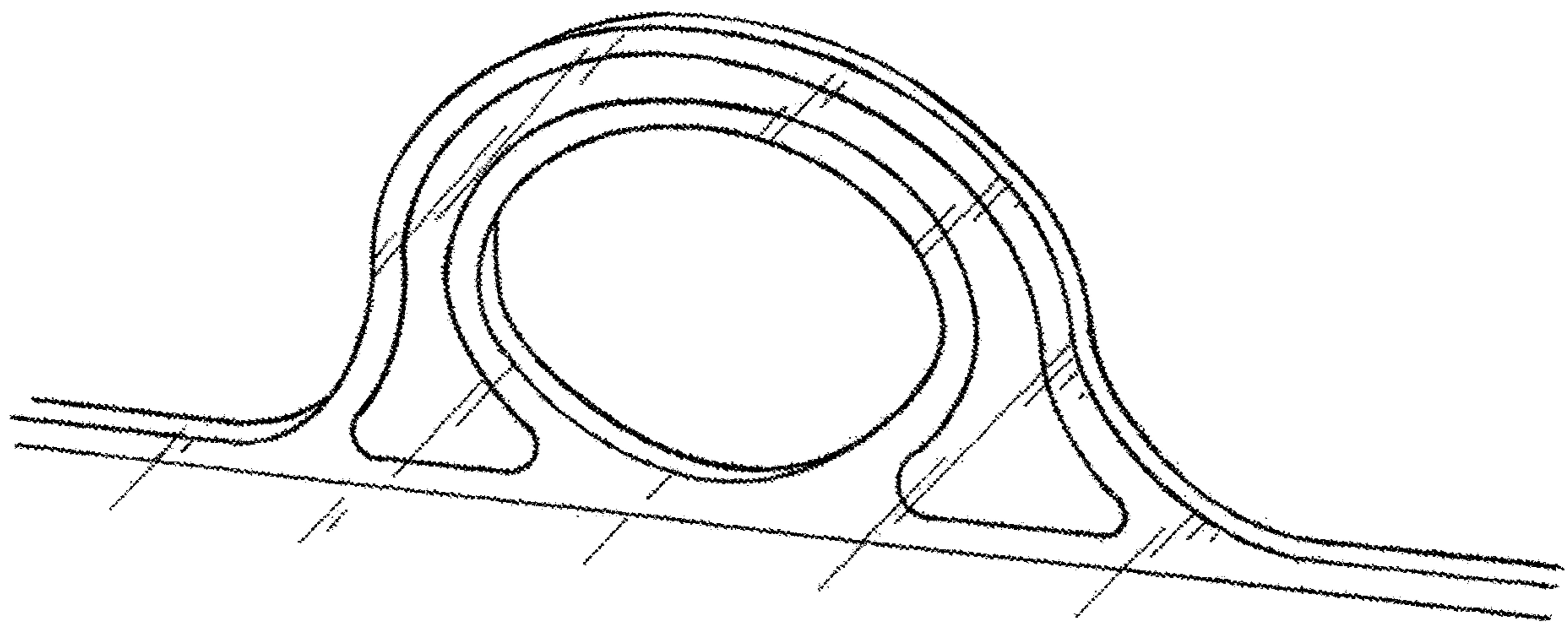

FIG. 5

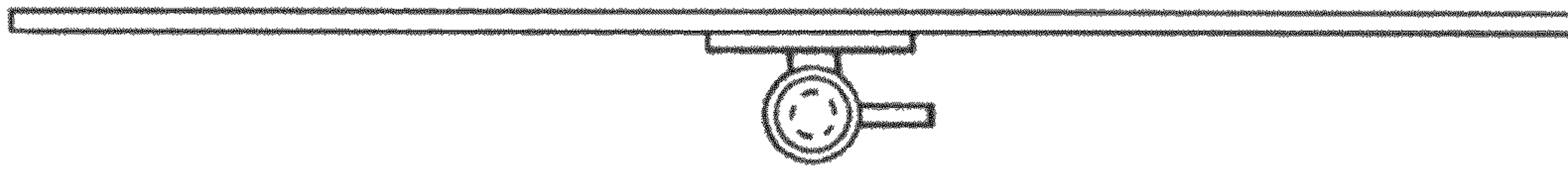

FIG. 6



FIG. 7

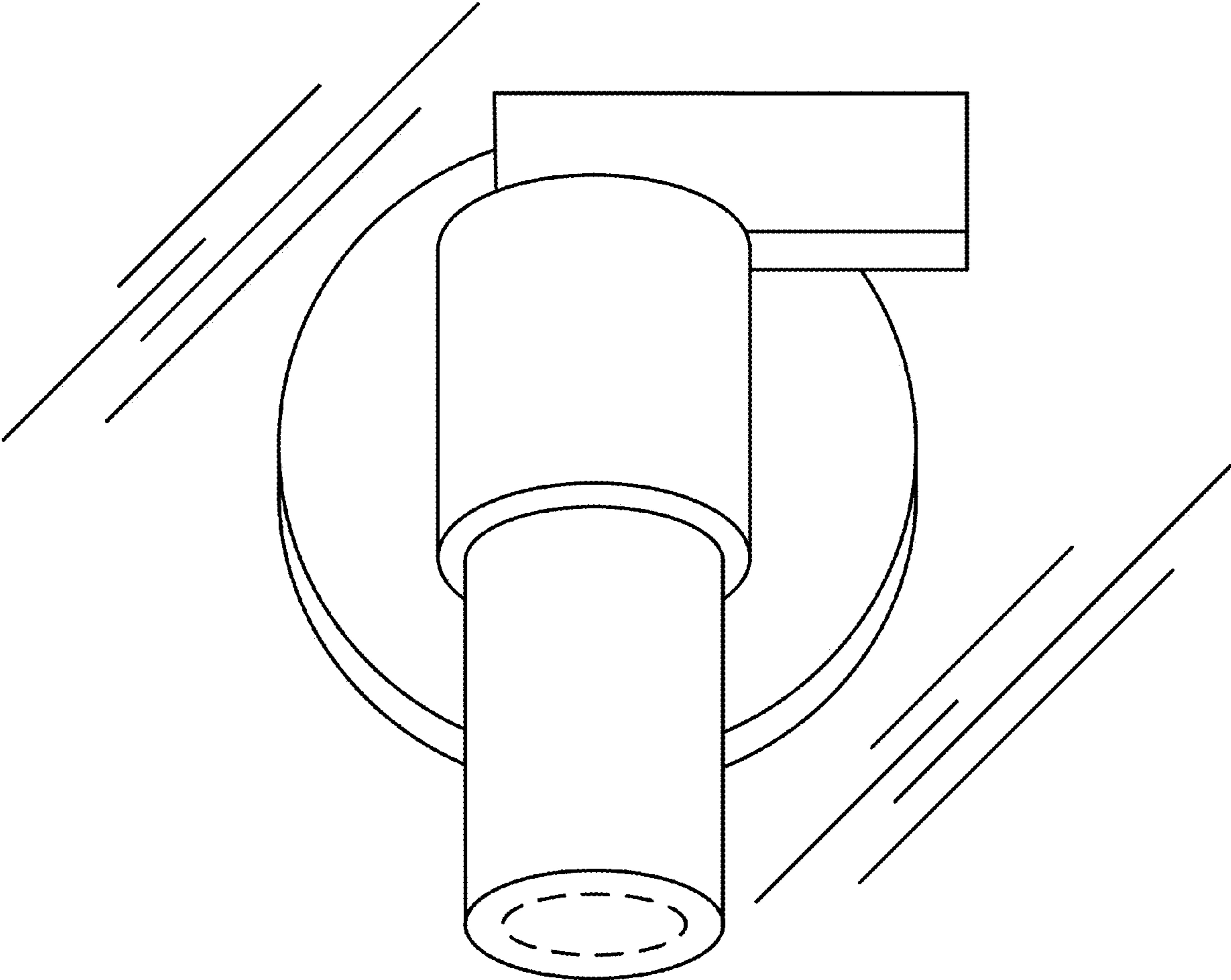

FIG. 9