



US00D912394S

(12) **United States Design Patent** (10) **Patent No.:** **US D912,394 S**
Young (45) **Date of Patent:** **** Mar. 9, 2021**

(54) **BABY CARRIER**

(71) Applicant: **Mary Elizabeth Young**, South Jordan, UT (US)

(72) Inventor: **Mary Elizabeth Young**, South Jordan, UT (US)

(**) Term: **15 Years**

(21) Appl. No.: **29/715,276**

(22) Filed: **Nov. 29, 2019**

Related U.S. Application Data

(63) Continuation of application No. 29/671,656, filed on Nov. 29, 2018, now Pat. No. Des. 876,824, which is (Continued)

(51) **LOC (13) Cl.** **03-99**

(52) **U.S. Cl.**
USPC **D3/213**

(58) **Field of Classification Search**
USPC D3/213, 214, 216
(Continued)

(56) **References Cited**

U.S. PATENT DOCUMENTS

5,678,739 A 10/1997 Darling et al.
D409,373 S 5/1999 Fair et al.
(Continued)

OTHER PUBLICATIONS

Original Happy Baby Carrier, <https://happybabycarriers.com/products/happy-baby-carrier?variant=32356401512535> (Year: 2020).*
(Continued)

Primary Examiner — Steven J Czyz

(74) *Attorney, Agent, or Firm* — Dentons Durham Jones Pinegar; Sarah W. Matthews

(57) **CLAIM**

I claim the ornamental design for a baby carrier, substantially as shown and described.

DESCRIPTION

FIG. 1 is a perspective view of a baby carrier showing the new design;
FIG. 2 is a front view of a baby carrier showing the new design;
FIG. 3 is a rear view of a baby carrier showing the new design;
FIG. 4 is a left side view of a baby carrier showing the new design;
FIG. 5 is a right view of a baby carrier showing the new design;
FIG. 6 is a top view of a baby carrier showing the new design;
FIG. 7 is a bottom view of a baby carrier showing the new design;
FIG. 8 is a perspective view of the baby carrier showing the new design with the hood deployed;
FIG. 9 is a front view of the baby carrier showing the new design with the hood deployed;
FIG. 10 is a rear view of the baby carrier showing the new design with the hood deployed;
FIG. 11 is a left side view of the baby carrier showing the new design with the hood deployed;
FIG. 12 is a right side view of view of the baby carrier showing the new design with the hood deployed;
FIG. 13 is a top view of the baby carrier showing the new design with the hood deployed; and,
FIG. 14 is a bottom view of the baby carrier showing the new design with the hood deployed.
The dotted lines show claimed stitching on the baby carrier. The dashed lines form no part of the claimed design.

1 Claim, 14 Drawing Sheets

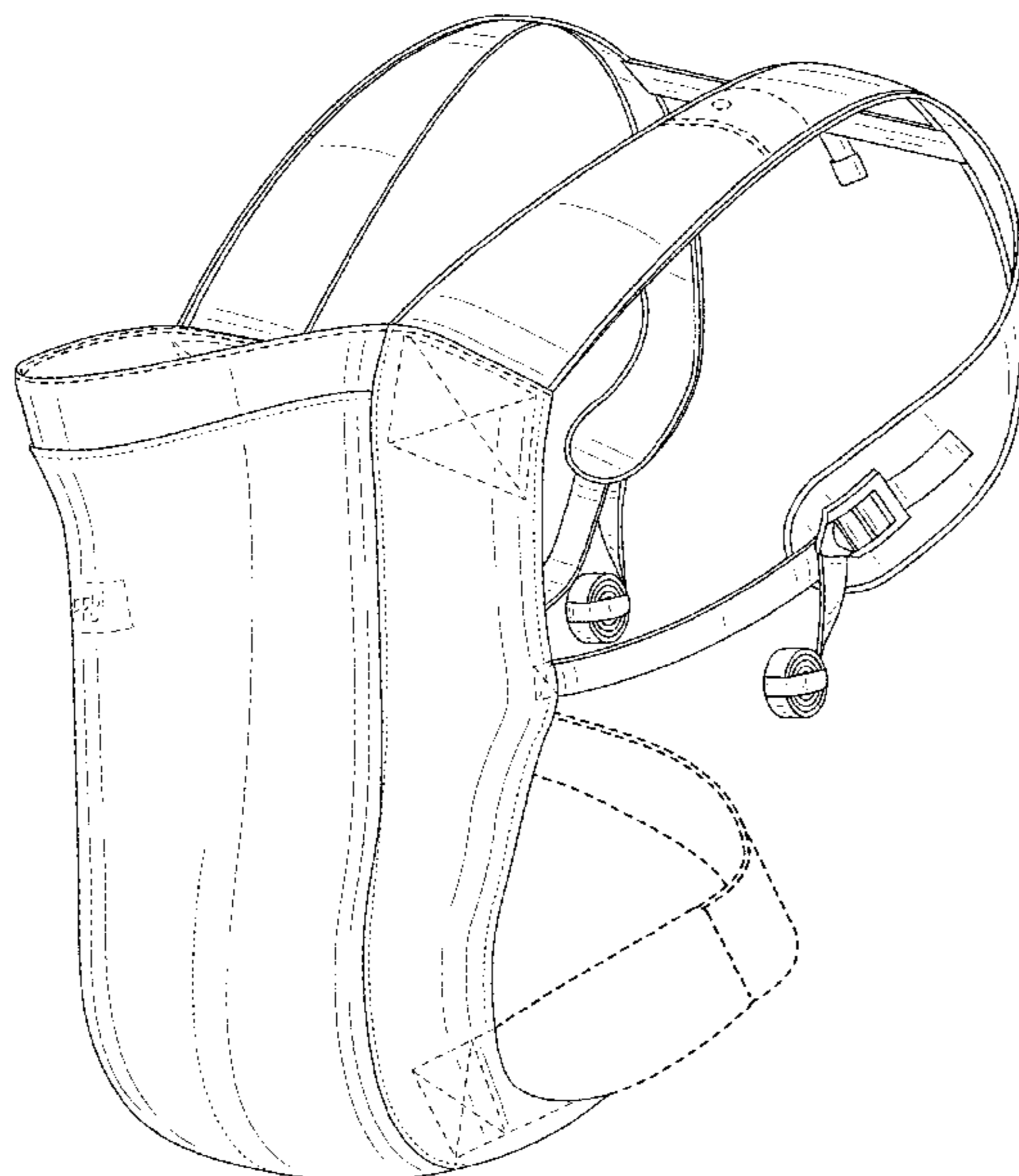

Related U.S. Application Data

a continuation of application No. 29/608,852, filed on Jun. 26, 2017, now Pat. No. Des. 835,902.

(58) **Field of Classification Search**

CPC A47D 13/02; A47D 13/025; A47D 13/086; A47D 15/00; A47D 15/006; A45F 3/047; A45F 2003/045

See application file for complete search history.

(56) **References Cited**

U.S. PATENT DOCUMENTS

D425,696 S 5/2000 Swanke
D507,102 S * 7/2005 Bergkvist A47D 13/025
D3/214
D507,869 S 8/2005 Liistro et al.
D611,699 S * 3/2010 Lundh D3/214
D615,750 S * 5/2010 Jones D3/214
7,766,199 B1 * 8/2010 Caperon A47D 13/025
224/160
D623,402 S 9/2010 Bergkvist
D642,375 S * 8/2011 Zack D3/214
8,028,871 B2 * 10/2011 Gray A47D 13/025
224/160
D649,345 S * 11/2011 Bergkvist D3/214
D655,494 S 3/2012 Murray et al.
D655,495 S * 3/2012 Sauer D3/214
8,172,116 B1 * 5/2012 Lehan A47D 13/025
224/160
D664,351 S * 7/2012 Bergkvist D3/214
D692,227 S * 10/2013 Andren D3/213
D693,569 S * 11/2013 Lehan D3/214
8,579,168 B2 * 11/2013 Zack A47D 13/025
224/160
8,701,949 B1 4/2014 Lehan et al.
D712,134 S * 9/2014 Gunter D3/214
D714,045 S * 9/2014 Stave D3/213
D733,419 S * 7/2015 Wikner D3/214
9,185,993 B2 11/2015 Telford et al.
D745,263 S * 12/2015 Tagle D3/213
D748,907 S * 2/2016 Figler D3/213
D753,385 S * 4/2016 Stave D3/213
D755,508 S * 5/2016 Chuah D3/213
9,386,863 B1 * 7/2016 Antunovic A47D 13/025
D770,166 S * 11/2016 Figler D3/213
D796,834 S * 9/2017 Pos D3/213
9,788,664 B2 * 10/2017 Andren A47D 13/025
D802,912 S * 11/2017 Brodin D3/213
D803,549 S * 11/2017 Warfaa D3/214
9,848,713 B2 12/2017 Rosen
D807,025 S * 1/2018 Elmberg D3/214
D827,293 S * 9/2018 Banach D3/214
D833,735 S * 11/2018 Hauser D3/214
D835,902 S * 12/2018 Young D3/214
D841,976 S * 3/2019 Tormans D3/214
10,264,894 B2 * 4/2019 Gibbons A47D 13/025
10,271,663 B2 * 4/2019 Salazar A47D 13/025
10,271,664 B2 * 4/2019 Yan A47D 13/025
D851,916 S * 6/2019 Andersson D3/214
D864,557 S * 10/2019 Sales D3/214
10,433,656 B2 * 10/2019 Lundh A47D 13/025
D866,955 S * 11/2019 Napier D3/214
10,555,620 B2 * 2/2020 Gibbons A47D 13/025
D876,824 S * 3/2020 Young D3/214
D876,825 S * 3/2020 Napier D3/214
10,631,582 B2 * 4/2020 Brault A47D 13/02
10,653,251 B1 * 5/2020 Young A47D 15/006
10,743,678 B2 * 8/2020 Salazar A45F 3/047
10,750,879 B2 * 8/2020 Schachtner A47D 13/025
10,772,411 B2 * 9/2020 Kippen A45F 3/10
2005/0051582 A1 3/2005 Rost

2005/0184114 A1 * 8/2005 Hoff A47D 13/025
224/160
2005/0218168 A1 * 10/2005 Chua A47D 13/025
224/160
2008/0283560 A1 * 11/2008 Parness A47D 13/025
224/160
2010/0072236 A1 * 3/2010 Parness A47D 13/025
224/161
2010/0200626 A1 * 8/2010 Moftakhar A47D 13/025
224/160
2011/0089205 A1 * 4/2011 Coote A47D 15/006
224/160
2011/0240693 A1 * 10/2011 Parness A47D 13/025
224/160
2011/0290831 A1 * 12/2011 Wang A47D 13/025
224/160
2012/0061429 A1 * 3/2012 Sauer A47D 13/025
224/160
2012/0187161 A1 * 7/2012 Bergkvist A47D 13/025
224/160
2012/0187162 A1 * 7/2012 Bergkvist A47D 13/025
224/160
2014/0231472 A1 * 8/2014 Cha
2015/0196133 A1 * 7/2015 Rosen A47D 13/025
224/160
2015/0282639 A1 10/2015 Chuah
2016/0150893 A1 * 6/2016 Salazar A47D 13/025
224/160
2016/0227940 A1 * 8/2016 Wikner A47D 13/025
2017/0119173 A1 * 5/2017 Telford A47D 13/025
2017/0196374 A1 * 7/2017 Chen A47D 13/025
2017/0238722 A1 * 8/2017 Flaunty A47D 13/025
2017/0332806 A1 * 11/2017 Liu A47D 13/025
2020/0163466 A1 * 5/2020 Telford A47D 13/086

OTHER PUBLICATIONS

Oct. 17, 2016 Tradeshow, Happy Baby display by inventory Mary Elizabeth Young.
Babyhawk Mei tai baby carrier, available for purchase at least as early as Mar. 30, 2011.
Beco Gemini, available at <<https://becobabycarrier.com/collections/beco-gemini>> at least as early as Jun. 24, 2016.
Boba 2G Baby Carrier, available for purchase at least as early as Feb. 24, 2010.
Boba 3G Baby Carrier, available for purchase at least as early as Jan. 22, 2012.
Boba 4G Baby Carrier, available for purchase at least as early as Nov. 17, 2013.
Boba Air, available for purchase at least as early as Jun. 26, 2014.
CatBird Baby Mei tai baby carrier, available for purchase at least as early as Mar. 30, 2011.
Catbird Pikkolo baby carrier, available at <https://catbirdbaby.com/products/pikkolo-soft-structured-baby-carrier?variant=1521908294>.
Free-to-Grow Baby Carrier by Baby Tula, available at <<https://babytula.com/products/stormy-tula-free-to-grow-baby-carrier?variant=43810370378>>.
Original Baby Carrier by Ergobaby, available at <<https://store.ergobaby.com/baby-carrieroriginal-collection/original-moonstone>>.
Tula Free-to-grow Coast baby carrier, available for purchase at least as early as Mar. 23, 2019.
“Boba Classic 4GS Carrier, available at <<https://boba.com/collections/boba-4gs-carrier/products/boba-carrier-birds-of-a-feather>>”.
“Connecta baby carrier, available at <https://connectacarrier.co.uk/>, at least as early as Dec. 15, 2017”.
“Integra baby carrier, available at <https://itegrababy.co.uk>, at least as early as Sep. 30, 2017”.

* cited by examiner

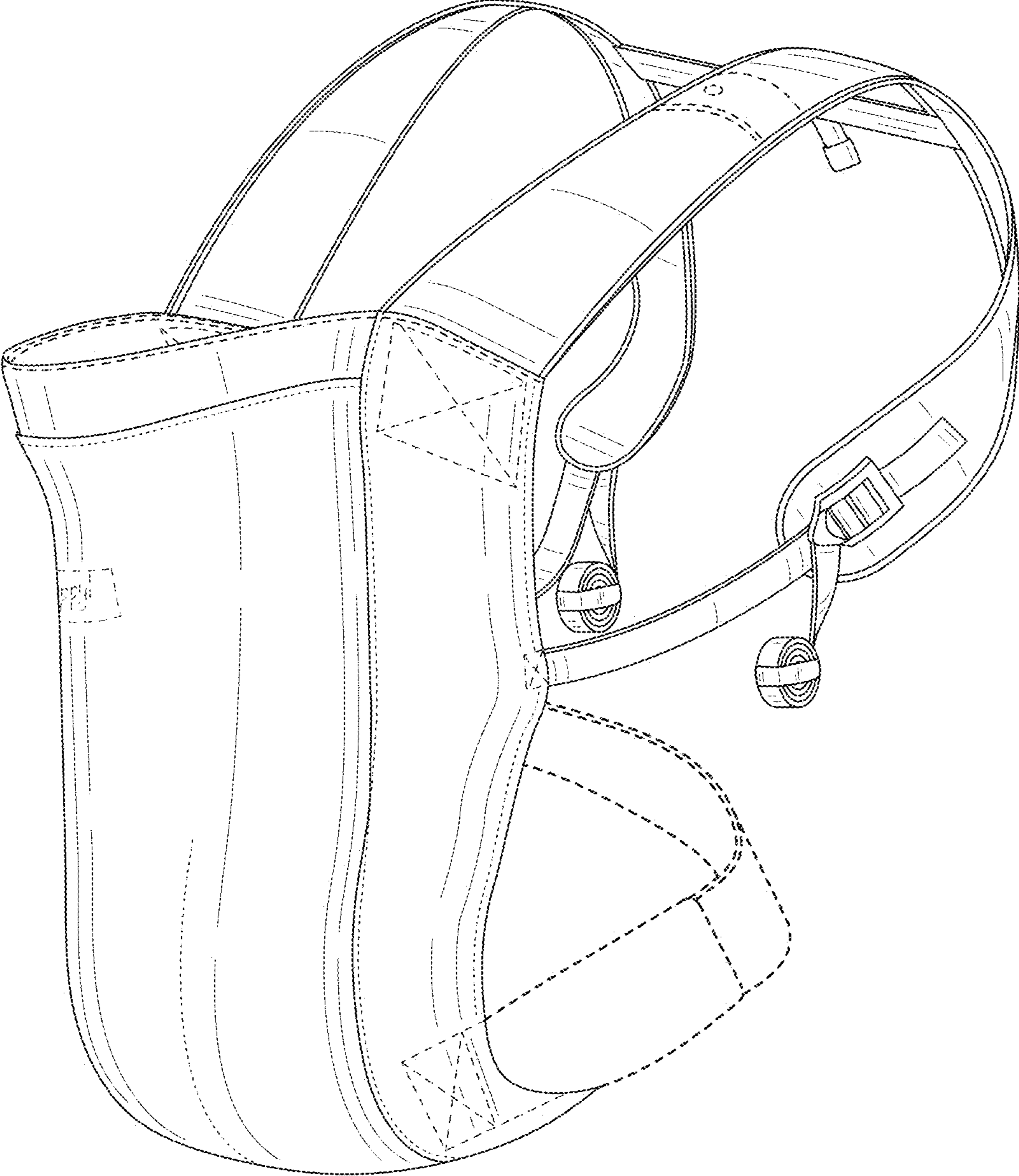

FIG. 1

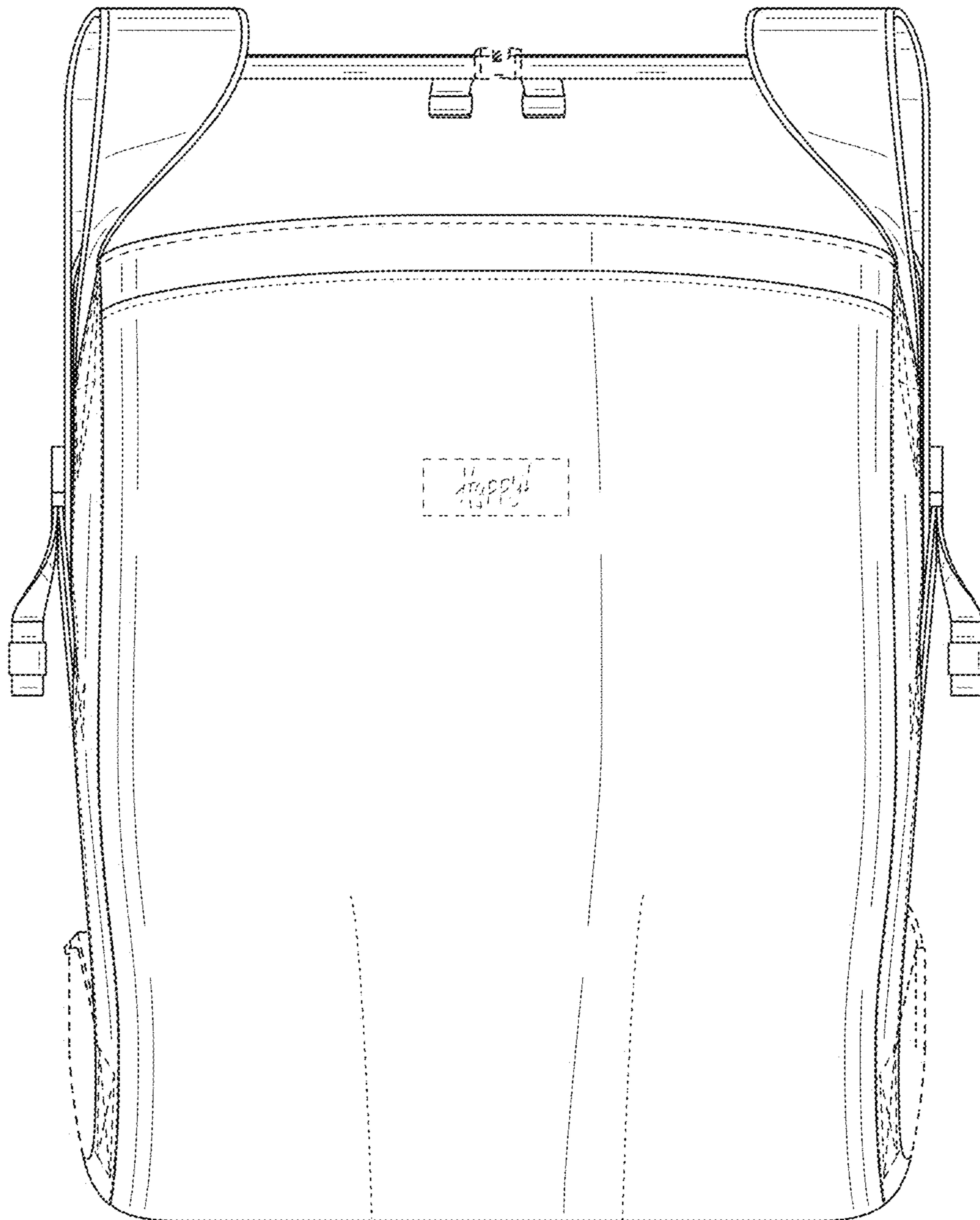

FIG. 2

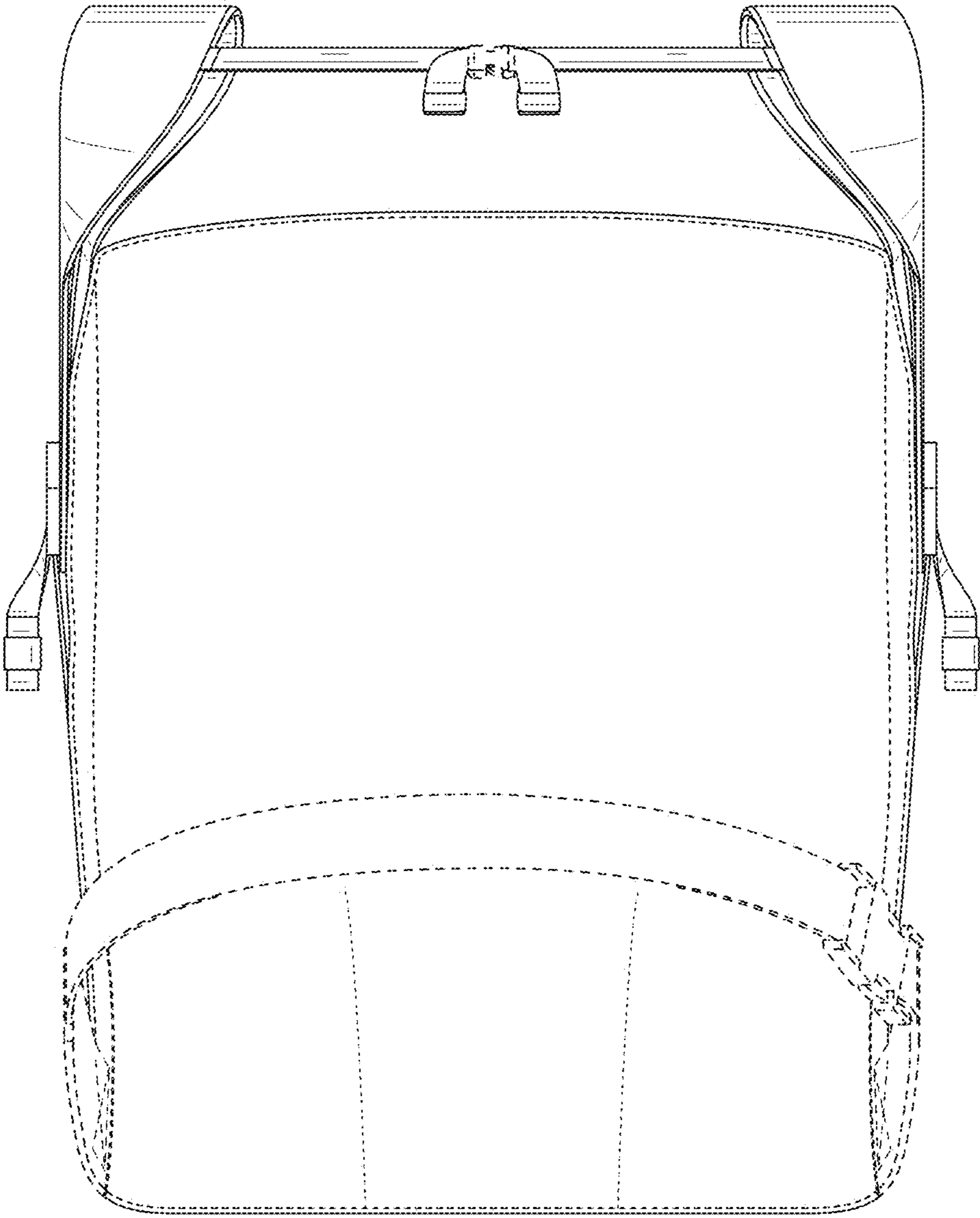

FIG. 3

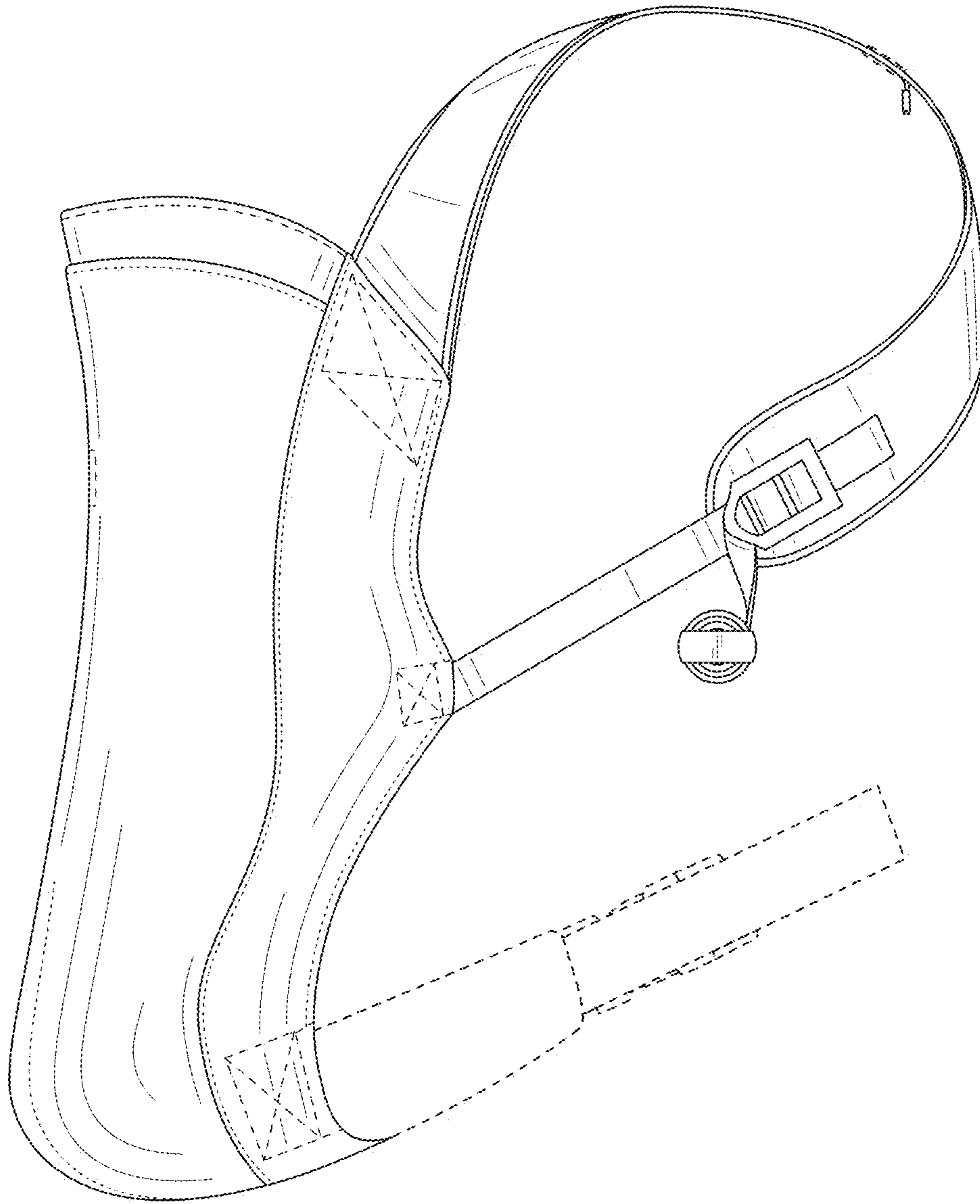

FIG. 4

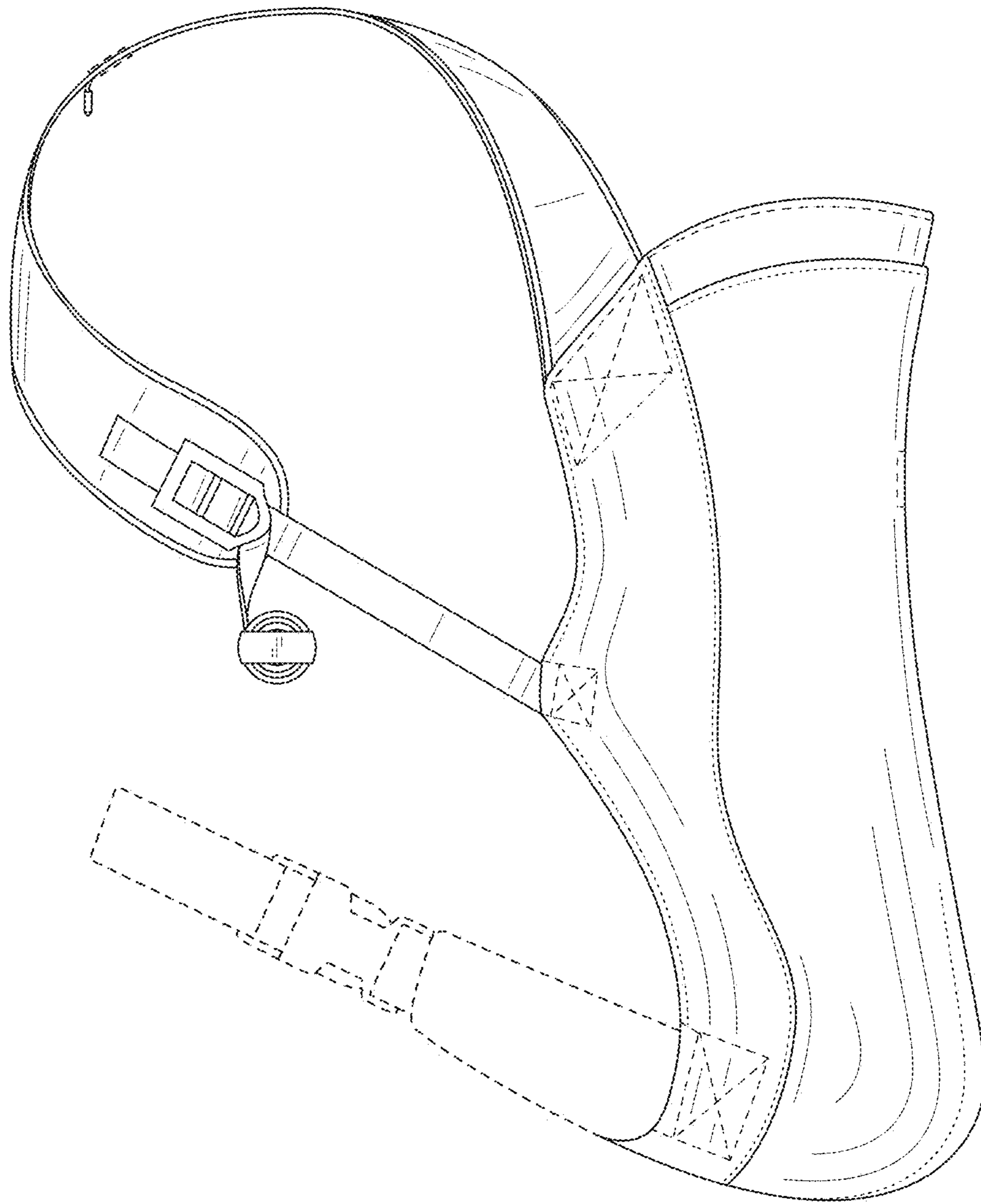

FIG. 5

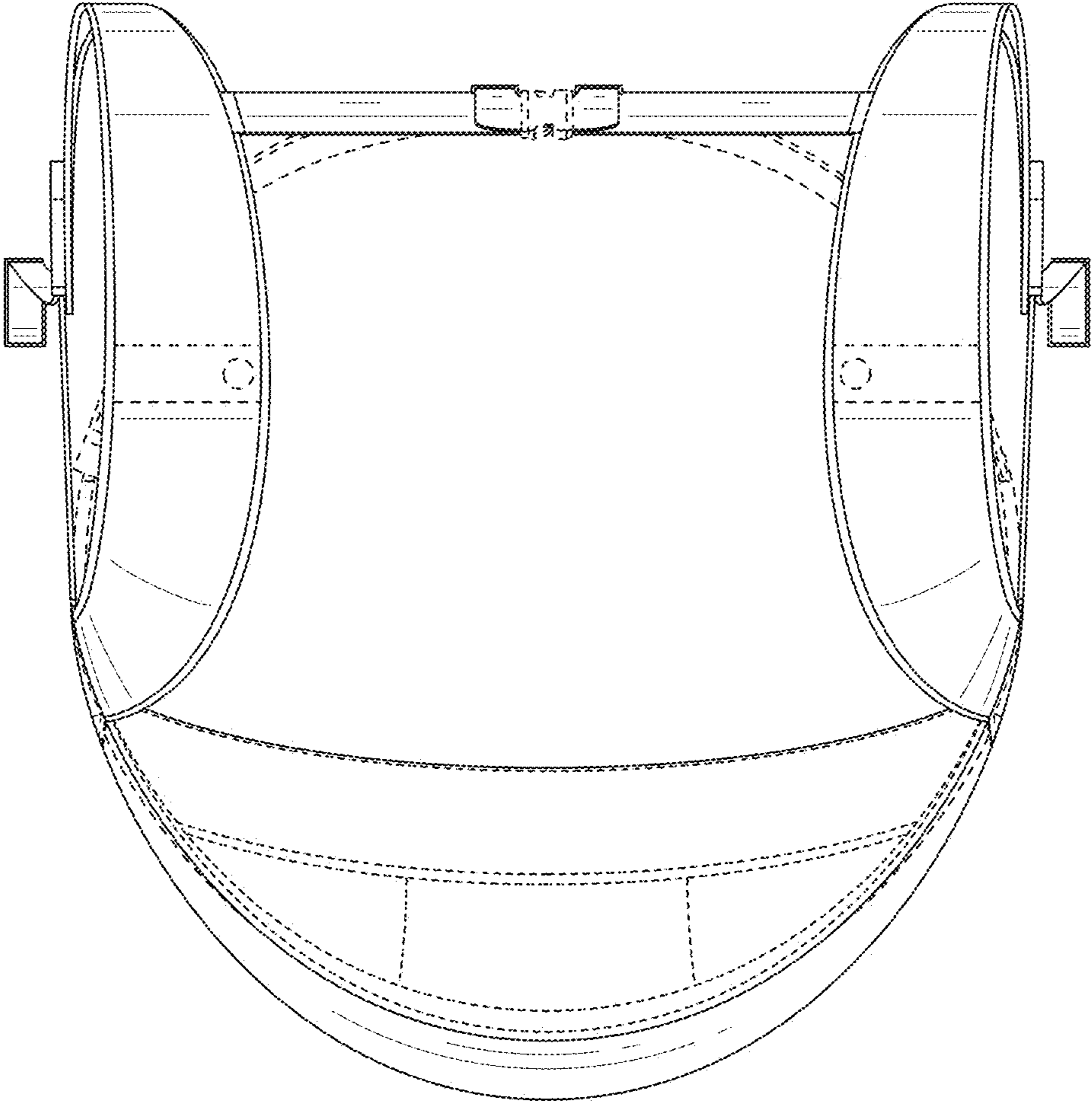

FIG. 6

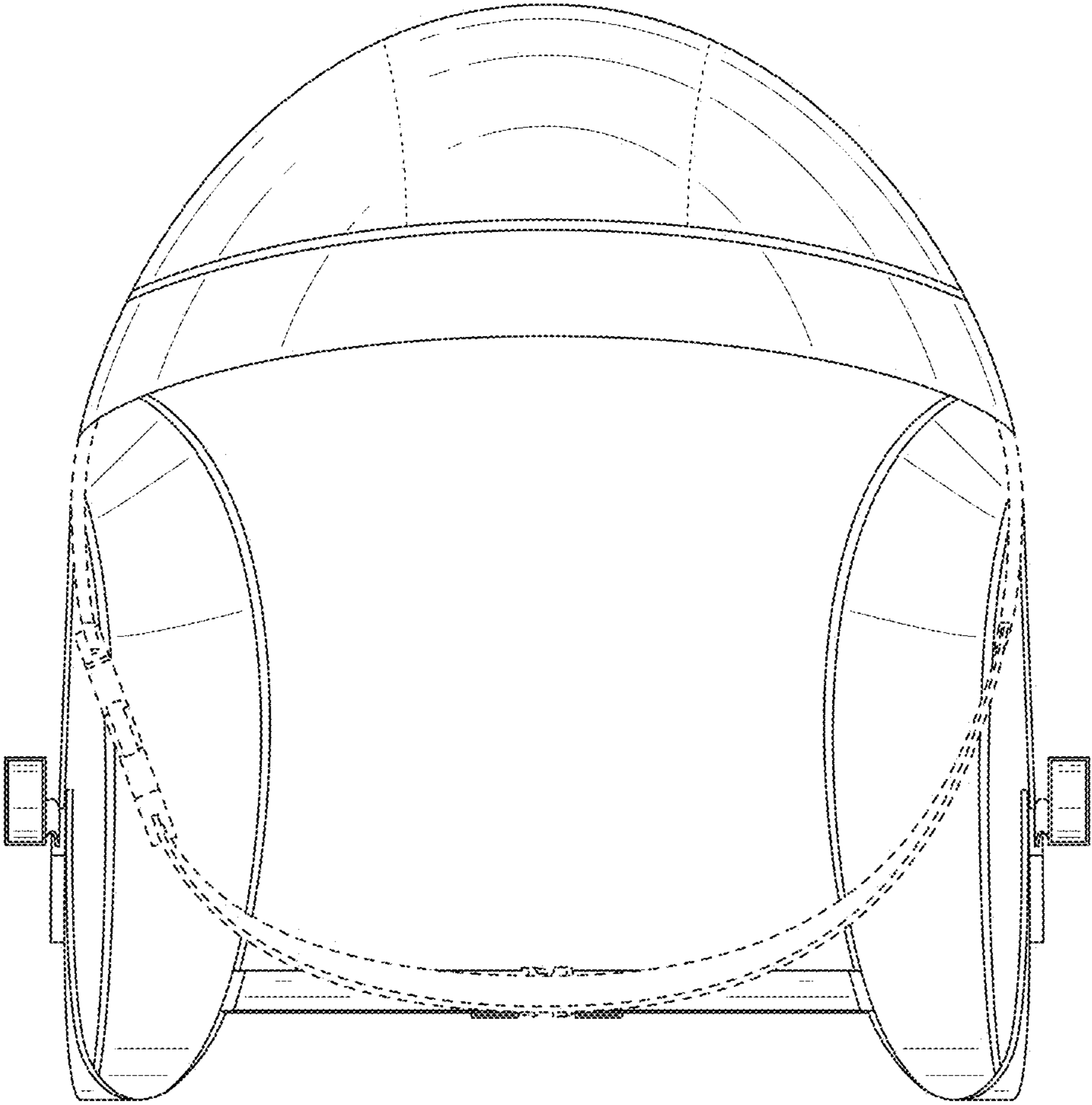

FIG. 7

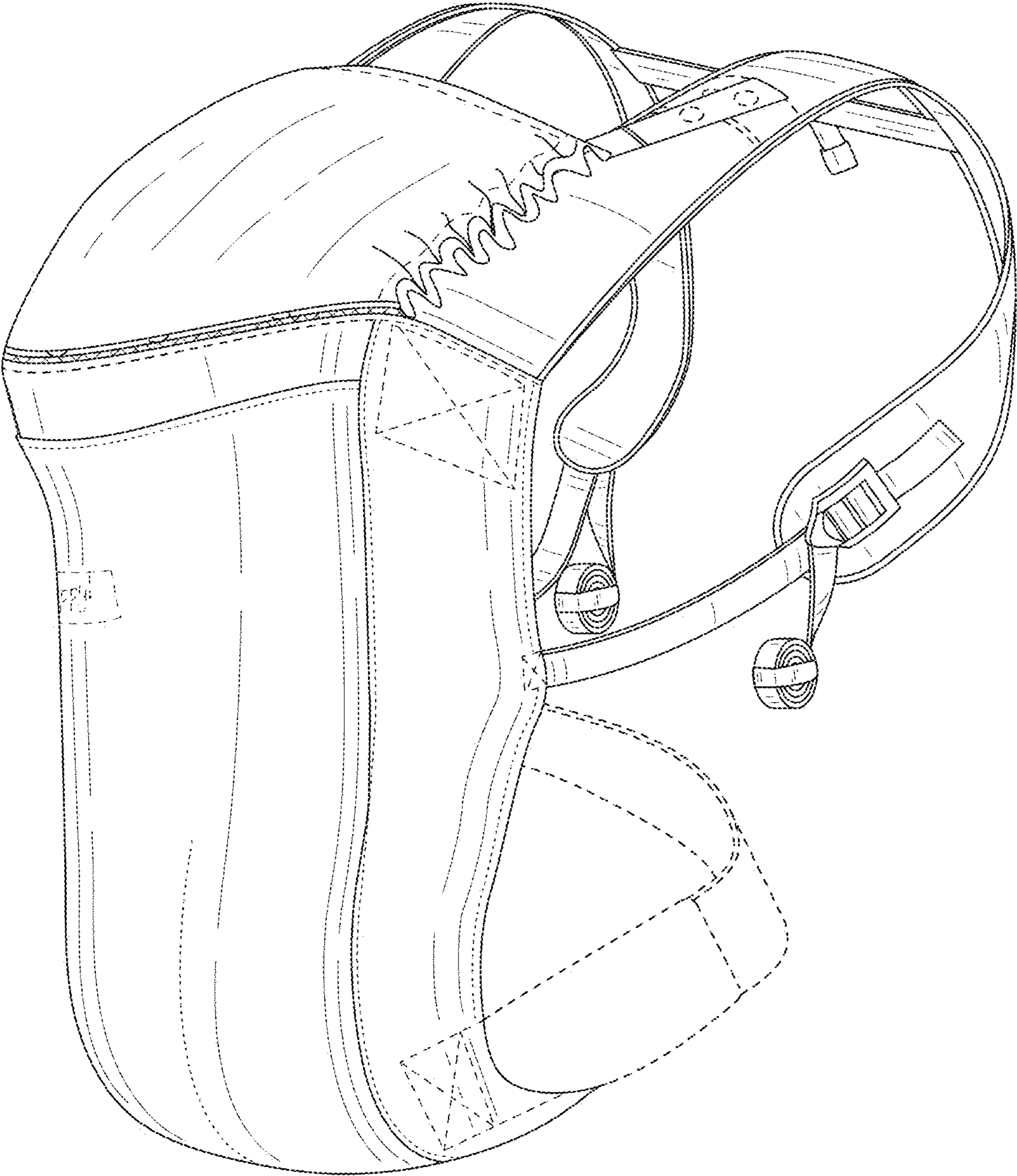

FIG. 8

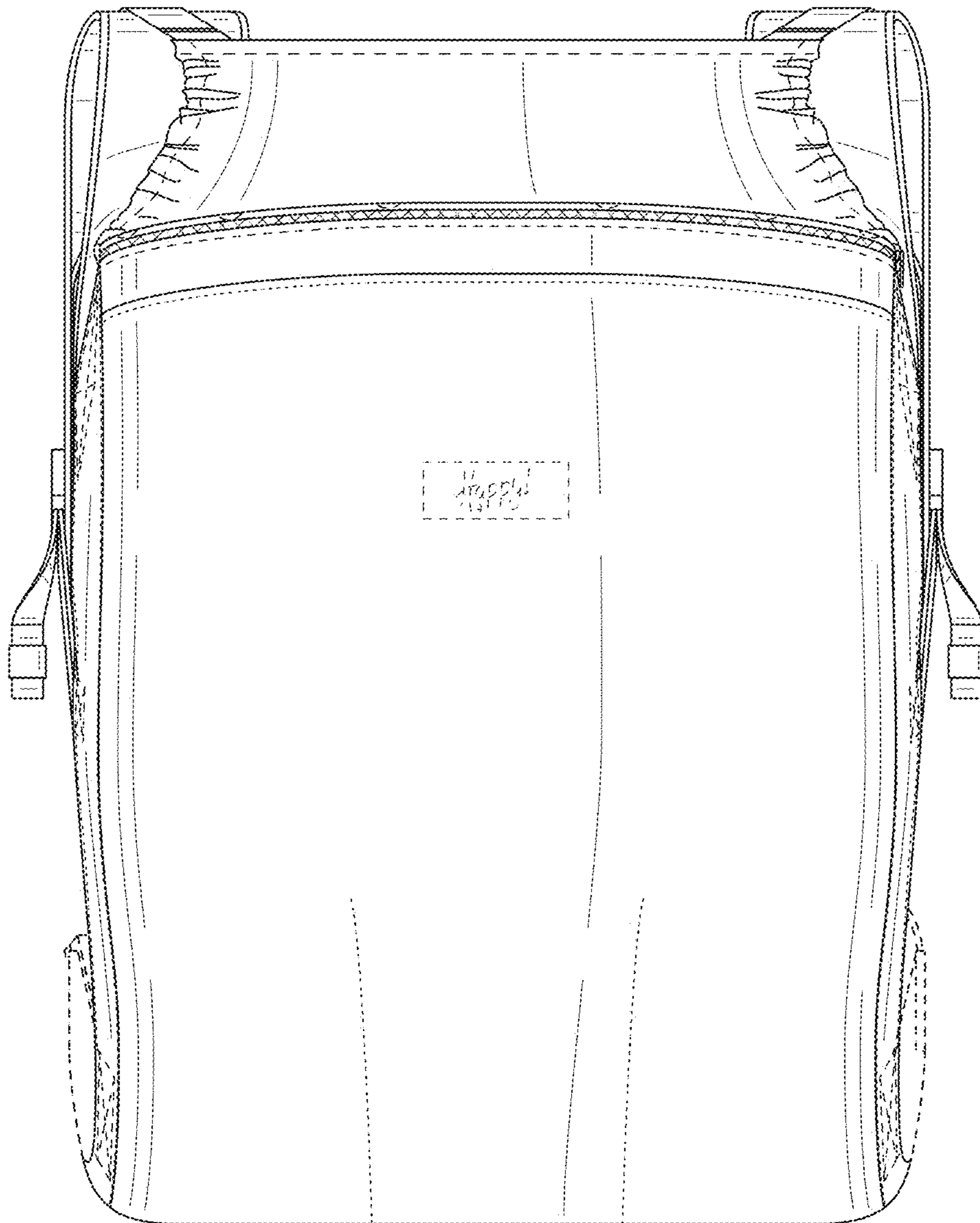

FIG. 9

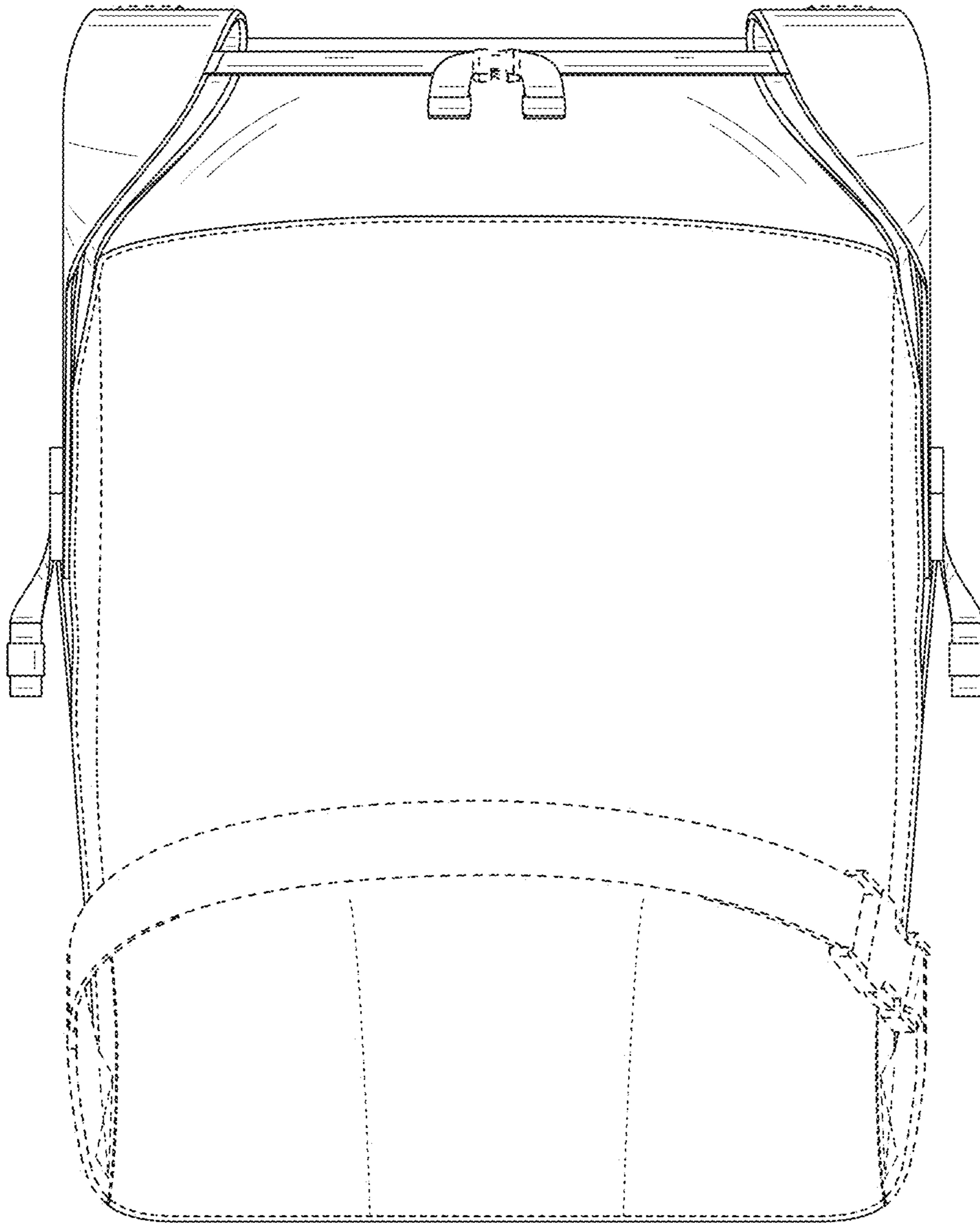

FIG. 10

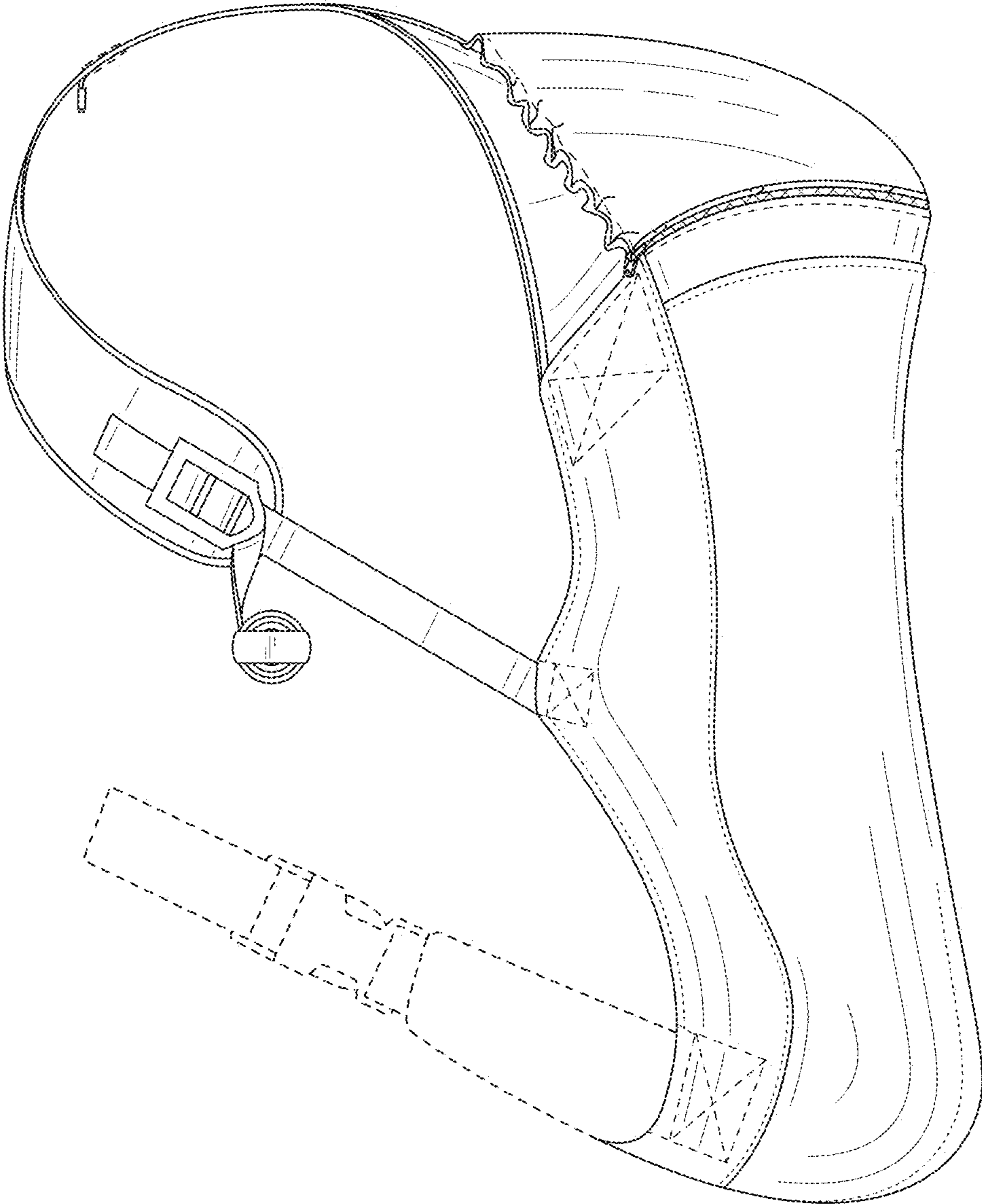

FIG. 11

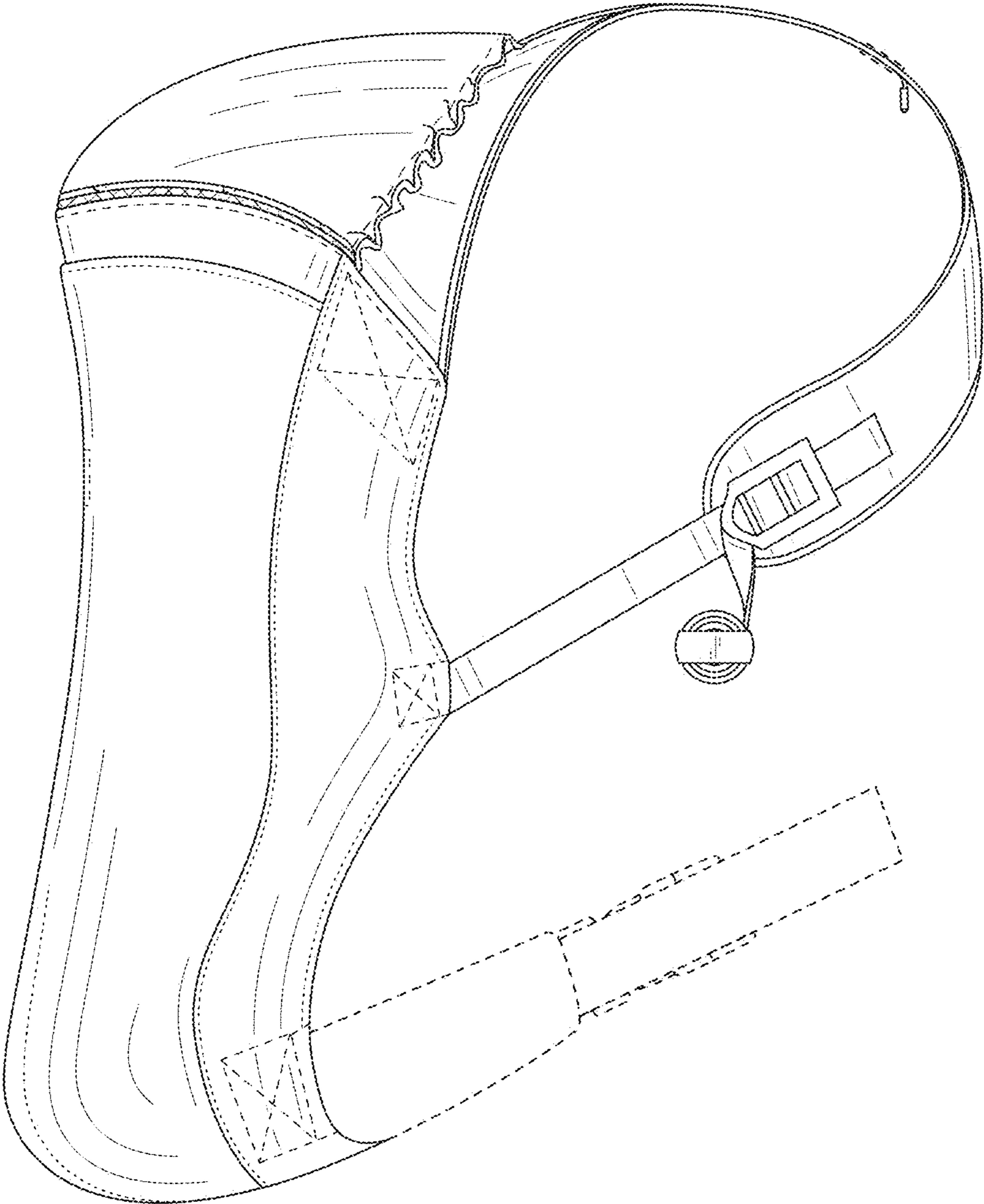

FIG. 12

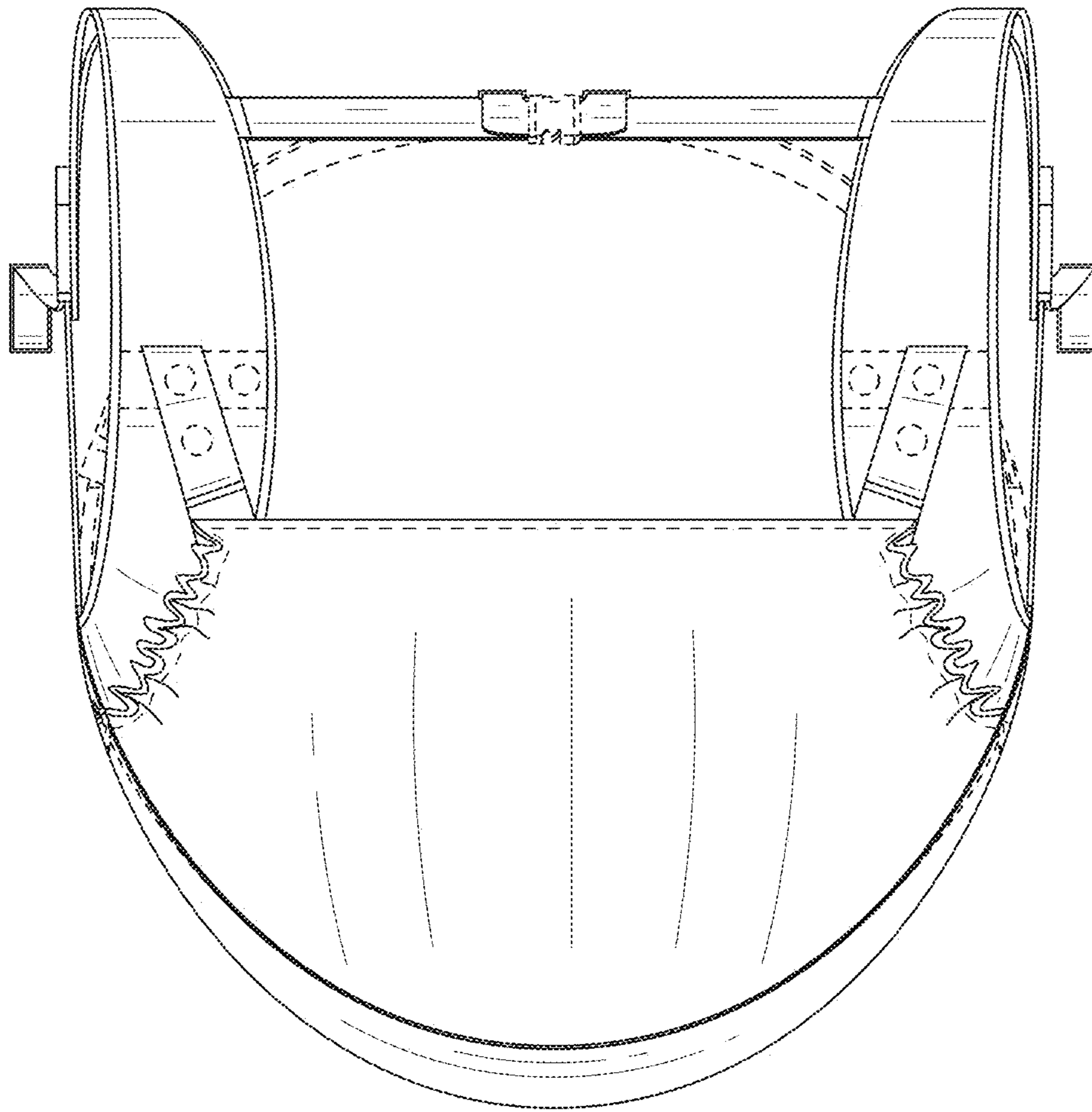

FIG. 13

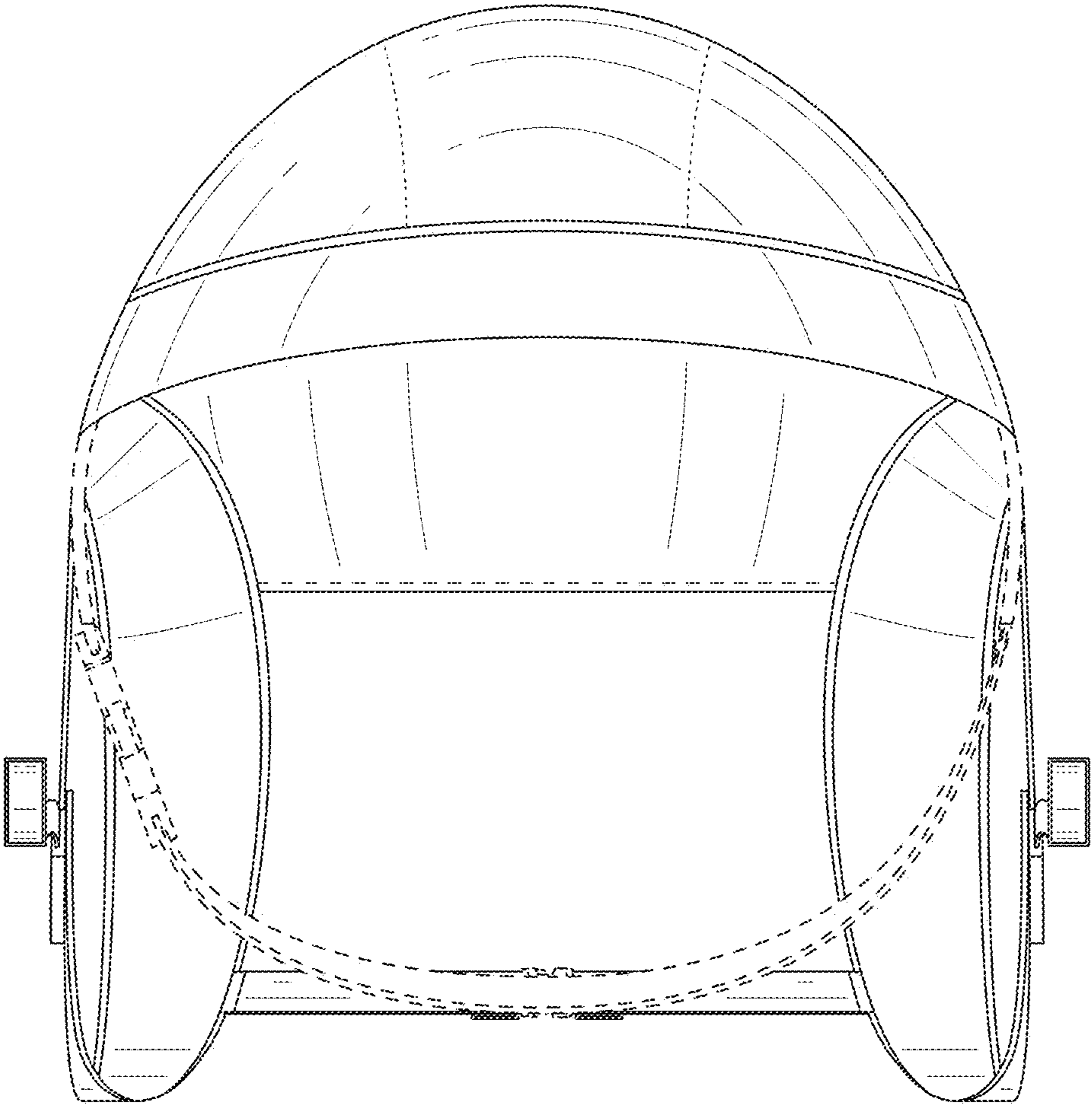

FIG. 14