



US00D912370S

(12) **United States Design Patent** (10) **Patent No.:** **US D912,370 S**
Ngan (45) **Date of Patent:** **** Mar. 9, 2021**

(54) **HOODED GARMENT**
(71) Applicant: **Shun On John Ngan**, Carson, CA (US)
(72) Inventor: **Shun On John Ngan**, Carson, CA (US)

D225,489 S * 12/1972 Graham D2/750
3,797,043 A 3/1974 Brument
3,837,006 A 9/1974 Laseman
(Continued)

(**) Term: **15 Years**

FOREIGN PATENT DOCUMENTS

(21) Appl. No.: **29/704,843**

CA 2720578 5/2012
CA 144154 11/2013
(Continued)

(22) Filed: **Sep. 6, 2019**

OTHER PUBLICATIONS

(51) **LOC (13) Cl.** **02-02**

(52) **U.S. Cl.**
USPC **D2/831; D2/828**

Catalonia Over sized Sweatshirt, posted 2019 [online], (retrieved Oct. 1, 2020), Retrieved from the internet, [://www.amazon.com/Catalonia-Oversized-Sweatshirt-Comfortable-Teenagers/dp/B07Z3NP6SK/ref=cm_cr_ap_d_product_top?ie=UTF8&th=1](http://www.amazon.com/Catalonia-Oversized-Sweatshirt-Comfortable-Teenagers/dp/B07Z3NP6SK/ref=cm_cr_ap_d_product_top?ie=UTF8&th=1) (Year: 2019).*

(58) **Field of Classification Search**
USPC D2/750, 760, 828-829, 831, 830,
D2/823-826, 860; 2/84
CPC .. A41B 1/00; A41B 3/005; A41B 3/02; A41B
3/04
See application file for complete search history.

(Continued)

(56) **References Cited**

Primary Examiner — Kevin K Rudzinski
Assistant Examiner — J. Thorn, Sr.
(74) *Attorney, Agent, or Firm* — Cislo & Thomas, LLP

U.S. PATENT DOCUMENTS

(57) **CLAIM**

- 1,097,530 A 5/1914 Cabelinsky
- 1,243,206 A 10/1917 Norman
- 1,432,249 A 10/1922 Robert
- 1,643,440 A 9/1927 Baldwin
- 1,905,235 A 4/1933 Mandelert
- D108,875 S 3/1938 Friedman
- D113,194 S * 1/1939 Storey D2/831
- 2,143,931 A 1/1939 Aronson
- 2,260,427 A 10/1941 Bailey
- 2,292,347 A 8/1942 Bailey
- 2,372,110 A 3/1945 Noone
- 2,420,344 A 5/1947 Alexander
- 2,865,025 A 12/1958 Hennessey
- 2,873,449 A 2/1959 Herbert
- 2,967,306 A 1/1961 Fabanich
- 3,079,611 A 3/1963 Boryszewski
- D196,096 S 8/1963 Griffith
- 3,116,491 A 1/1964 Previdi et al.
- 3,381,306 A 5/1968 Innes

The ornamental design for a hooded garment, as shown and described.

DESCRIPTION

FIG. 1. is a perspective view of my hooded garment;
FIG. 2. is a front view thereof;
FIG. 3. is a right side view thereof;
FIG. 4. is a left side view thereof;
FIG. 5. is a back view thereof;
FIG. 6. is a top view thereof;
FIG. 7. is a bottom view thereof;
FIG. 8. is a front view thereof with the sleeves down; and,
FIG. 9. is a rear view thereof with the sleeves down.
The broken lines shown in the drawings depict environment that forms no part of the claimed design.

1 Claim, 7 Drawing Sheets

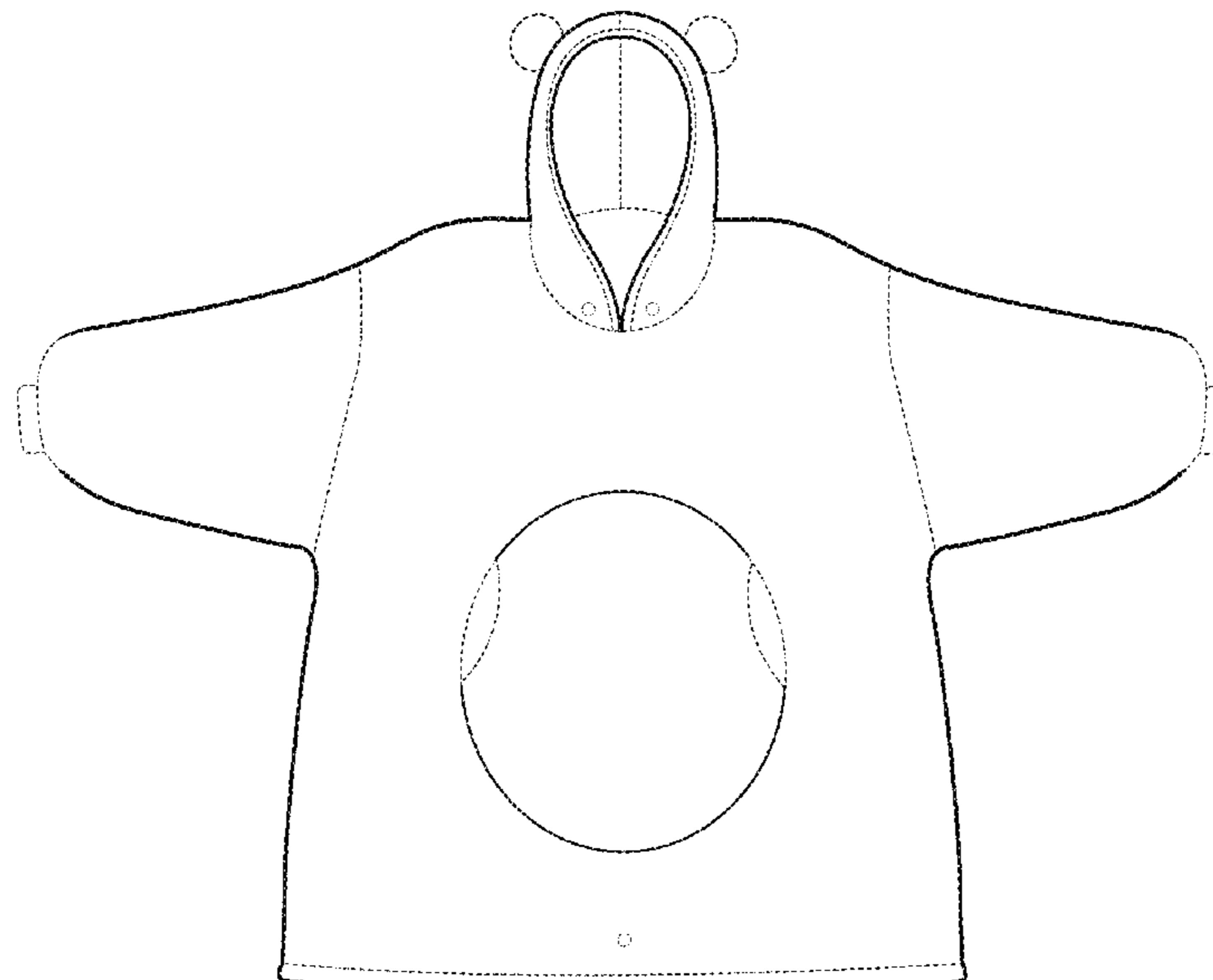

(56)

References Cited

U.S. PATENT DOCUMENTS

4,055,853 A	11/1977	Argento et al.	D653,836 S	2/2012	Woyshner et al.
D247,331 S	2/1978	Nally	D663,105 S	7/2012	Selivon
D247,526 S	3/1978	Nally	D672,531 S *	12/2012	Kelfer D2/750
4,078,264 A	3/1978	DeGennaro	D674,167 S	1/2013	Ehler
4,227,264 A	10/1980	Spector et al.	D677,859 S	3/2013	Andes
4,370,755 A	2/1983	Crumby	D677,860 S	3/2013	Kim
4,404,687 A	9/1983	Hager	D679,479 S	4/2013	Carrera et al.
4,502,155 A	3/1985	Itoi	D679,484 S	4/2013	Brown
D294,535 S	3/1988	Stricklin	8,424,113 B2	4/2013	Sprole
D296,605 S	7/1988	Asher	8,424,114 B2	4/2013	Snyder et al.
4,791,681 A	12/1988	Dean	D683,523 S	6/2013	Freedman
4,862,519 A	9/1989	Bull	D684,341 S	6/2013	Freedman
4,928,321 A	5/1990	Dobson	D684,409 S	6/2013	Juarez
D312,721 S	12/1990	Shea	D686,408 S	7/2013	Stemlight
5,086,516 A	2/1992	Baxter et al.	D687,210 S	8/2013	Krafnick
D325,459 S	4/1992	Keever	D690,078 S	9/2013	Anderson
5,119,510 A	6/1992	Schilling	D690,486 S	10/2013	Yan
5,206,957 A	5/1993	Gulick	D692,212 S	10/2013	Coward
D351,712 S	10/1994	Jackson	8,566,963 B2	10/2013	Ryan
D360,517 S	7/1995	Reizenstein	D693,540 S	11/2013	Vanneste
D365,193 S	12/1995	Dodd, Jr.	D693,541 S	11/2013	Vanneste
D385,088 S	10/1997	Handysides	8,578,515 B1	11/2013	Petersen
5,697,102 A	12/1997	Benjamin	D701,677 S	4/2014	Tref
5,720,043 A	2/1998	White	D707,466 S	6/2014	Lancaster
5,787,504 A	8/1998	Wu	D708,423 S	7/2014	Adams et al.
5,850,634 A	12/1998	Toombs	D714,021 S	9/2014	Bowen
D414,013 S *	9/1999	Group D2/828	D714,524 S	10/2014	Borovicka
5,996,121 A	12/1999	Harris	8,864,544 B2	10/2014	Anderman et al.
6,006,356 A	12/1999	Song	D721,467 S	1/2015	Tref
6,014,772 A	1/2000	Connelly	D728,900 S *	5/2015	White D2/750
D430,721 S	9/2000	Beauchan	D732,800 S	6/2015	Brown
6,185,743 B1	2/2001	Mick	D736,496 S *	8/2015	Gonzalez D2/750
D439,029 S	3/2001	Goldman	D741,567 S	10/2015	Chang
6,219,847 B1	4/2001	Aikins	D741,576 S	10/2015	Sakosits
6,253,381 B1	7/2001	Kelley	D746,551 S	1/2016	Ingram
6,275,993 B1	8/2001	McCarley	D747,075 S	1/2016	Ingram
D453,607 S	2/2002	Tracy	D751,272 S	3/2016	Moehring
6,405,377 B1	6/2002	Davis	9,295,292 B2	3/2016	Sachs
D465,317 S	11/2002	Darling	D754,947 S	5/2016	Borovicka
D478,708 S	8/2003	Miros et al.	9,339,064 B2	5/2016	Oliver
D482,935 S	12/2003	Yamane	D758,046 S	6/2016	Grant
6,760,921 B1	7/2004	Simmons	D758,700 S	6/2016	Borovicka
D496,144 S	9/2004	Bourget	D762,345 S	8/2016	Adams et al.
6,839,911 B1	1/2005	Mathews	9,414,631 B2	8/2016	Schrimpf
6,848,118 B2 *	2/2005	Barnes A41D 3/005 2/108	D765,349 S	9/2016	Hou
D507,693 S	7/2005	Walton	D765,351 S	9/2016	Shaw
6,922,848 B1	8/2005	Stanley	D767,255 S	9/2016	Marino
7,065,810 B2	6/2006	Robinson	D769,580 S	10/2016	Conway et al.
D541,011 S	4/2007	Day et al.	D770,136 S	11/2016	Darmour
D551,429 S	9/2007	Wager	9,554,601 B2	1/2017	Arajakis
D553,329 S	10/2007	Wager	D784,659 S	4/2017	Darmour
D553,330 S	10/2007	Wager	D785,285 S	5/2017	Shamsid-Deen
D565,456 S	4/2008	Anderson et al.	D785,906 S	5/2017	Darmour
7,418,740 B2	9/2008	Anderson et al.	D787,160 S	5/2017	Crowe et al.
D584,482 S	1/2009	Marsh	D790,809 S	7/2017	Lomax
D590,133 S	4/2009	Rogondino	D792,678 S	7/2017	Storlie et al.
D591,028 S	4/2009	Rogondino	9,713,352 B2	7/2017	Demarest
D594,633 S *	6/2009	Floyd D2/731	D801,005 S	10/2017	Perez
D600,884 S	9/2009	Patton	9,775,387 B2	10/2017	Parr
D601,327 S	10/2009	Anderson et al.	D801,948 S	11/2017	Picunko
D608,983 S	2/2010	Myers	D802,884 S	11/2017	Bennett
D609,432 S	2/2010	Jennings	D802,886 S	11/2017	Salce, Jr. et al.
D626,310 S	11/2010	Cruz	D809,745 S	2/2018	Crowe et al.
D626,720 S	11/2010	Pinkhasov	D810,401 S	2/2018	Darmour
D626,725 S	11/2010	Snyder et al.	D810,402 S	2/2018	Darmour
D627,540 S	11/2010	Claeys	D811,051 S	2/2018	Darmour et al.
D629,590 S	12/2010	Freedman et al.	D815,801 S	4/2018	Torre
D630,002 S	1/2011	Brown	D820,560 S	6/2018	Reynolds et al.
D630,003 S	1/2011	Brown	D822,344 S	7/2018	Karim
D630,820 S	1/2011	Wilson	D827,247 S	9/2018	Genender
D636,973 S	5/2011	Smith et al.	D827,248 S	9/2018	Genender
D638,612 S	5/2011	Benderradji	D827,249 S	9/2018	Darmour et al.
D645,645 S	9/2011	Dyer	10,080,391 B2	9/2018	Rundle
D648,923 S	11/2011	Morales	D830,735 S	10/2018	Johnson
			D831,937 S	10/2018	James
			10,130,126 B2	11/2018	Blauser
			D839,539 S	2/2019	Jones
			D839,546 S	2/2019	Noiberg
			D840,133 S	2/2019	Peck

(56)

References Cited

U.S. PATENT DOCUMENTS

D841,289 S 2/2019 Frost et al.
 D842,589 S 3/2019 Johnson
 10,265,636 B2 4/2019 Anderman et al.
 D854,787 S 7/2019 Ngan
 D856,032 S 8/2019 Hindley
 D859,788 S 9/2019 Speciale et al.
 10,420,431 B1 9/2019 Speciale et al.
 D862,841 S 10/2019 Lomax
 D862,843 S 10/2019 Darmour
 D862,845 S 10/2019 Plant et al.
 10,485,278 B2 11/2019 Noll et al.
 D886,416 S 6/2020 Speciale
 2001/0032360 A1 10/2001 Bertrand
 2002/0142112 A1 10/2002 Tarreii
 2003/0061659 A1 4/2003 Dunlap
 2003/0182714 A1 10/2003 Mariland et al.
 2004/0181844 A1 9/2004 Kim
 2004/0237167 A1 12/2004 Curry
 2005/0144695 A1 7/2005 Aldridge et al.
 2006/0010555 A1 1/2006 Hayes
 2007/0050882 A1 3/2007 Eisenhuth
 2007/0061940 A1 3/2007 Cazares
 2007/0083983 A1 4/2007 Barclay
 2007/0157359 A1 7/2007 Reardon et al.
 2007/0266473 A1 11/2007 Issel
 2008/0056508 A1 3/2008 Pierce et al.
 2008/0120774 A1 5/2008 Hite
 2008/0196140 A1 8/2008 Mayerson
 2008/0209612 A1 9/2008 Summer
 2008/0250560 A1 10/2008 Armstrong
 2009/0055991 A1 3/2009 Johnson et al.
 2009/0144874 A1 6/2009 Stein
 2009/0165206 A1 7/2009 Davis
 2009/0205117 A1 8/2009 Day et al.
 2009/0229034 A1 9/2009 Zmigrosky
 2009/0235426 A1 9/2009 Johnston et al.
 2010/0115684 A1 5/2010 Freedman et al.
 2010/0122395 A1 5/2010 Wall et al.
 2010/0146680 A1 6/2010 Cuoco
 2010/0186166 A1 7/2010 Sulentic
 2011/0179559 A1 7/2011 Smoot
 2011/0185471 A1 8/2011 Buczekowski
 2011/0206299 A1 8/2011 Carmody
 2012/0005802 A1 1/2012 Claeys
 2012/0023635 A1 2/2012 Ehler
 2012/0060254 A1 3/2012 Blade
 2012/0144550 A1 6/2012 Nejad
 2013/0000010 A1 1/2013 Ryan
 2013/0019378 A1 1/2013 White
 2013/0042383 A1 2/2013 Ryan et al.
 2013/0130540 A1 5/2013 Oman et al.
 2013/0152269 A1 6/2013 Coward
 2013/0152270 A1 6/2013 Neal et al.
 2013/0219581 A1 8/2013 Schrimpf
 2013/0219616 A1 8/2013 Bozek
 2013/0269082 A1 10/2013 Bramblet
 2014/0068834 A1 3/2014 Skinner
 2014/0082818 A1 3/2014 Nysheva-Starr

2014/0096305 A1 4/2014 Friesen
 2014/0215689 A1 8/2014 Perez
 2014/0237700 A1 8/2014 Albert
 2014/0259275 A1 9/2014 Walvius et al.
 2014/0310848 A1 10/2014 Ulriksen
 2014/0317824 A1 10/2014 Browning et al.
 2014/0331381 A1 11/2014 Arajakis
 2015/0121604 A1 5/2015 Lee et al.
 2015/0135397 A1 5/2015 Levine
 2015/0150319 A1 6/2015 Walmsley
 2015/0196061 A1 7/2015 Oliver
 2015/0250337 A1 9/2015 Gould
 2015/0296898 A1 10/2015 Bowen
 2015/0296909 A1 10/2015 Sachs
 2016/0157535 A1 6/2016 Tirro et al.
 2016/0174633 A1 6/2016 Macrae
 2016/0242474 A1 8/2016 Baschak
 2016/0309799 A1 10/2016 Nysheva-Starr
 2017/0020215 A1 1/2017 Merritt
 2017/0079350 A1 3/2017 Hourani
 2017/0164665 A1 6/2017 Johnson
 2017/0224030 A1 8/2017 Olivares Velasco
 2017/0224033 A1 8/2017 Latta, Jr.
 2017/0265545 A1 9/2017 Peng
 2017/0280793 A1 10/2017 Reyes
 2017/0311655 A1 11/2017 Gonzalez
 2018/0027889 A1 2/2018 Frost et al.
 2018/0049489 A1 2/2018 Noll
 2018/0092410 A1 4/2018 Rundle
 2018/0368496 A1 12/2018 Berrebi
 2019/0142089 A1 5/2019 Emes
 2019/0216191 A1 7/2019 Botha et al.
 2019/0254410 A1 8/2019 DuVall
 2019/0269184 A1 9/2019 Gracie
 2020/0008500 A1 1/2020 Speciale

FOREIGN PATENT DOCUMENTS

DM	091998	10/2016
GB	2551262	12/2017
JP	1046408	2/1998
JP	2006207103	10/2006
NL	9302143	7/1995
WO	2018222368	12/2018

OTHER PUBLICATIONS

Koretemp Poncho Liner posted to bushcraftoutfitters.com. Available date Jul. 17, 2019 [site visited Mar. 20, 2020]. Available: <<https://bushcraftoutfitters.com/koretemp-poncho-liner/>> (Year: 2019).
 Ho Stevie! Surf Poncho posted to amazon.com. Available date: Mar. 19, 2016 [site visited Mar. 20, 2020]. Available: <https://www.amazon.com/Ho-Stevie-Microfiber-Wetsuit-Changing/dp/B01CV1P9UG/ref=cm_cr_ar_p_d_product_top?ie=UTF8> (Year: 2016).
 The Comfy Original, posted 2018 [online], (retrieved Oct. 14, 2020), Retrieved from the internet, <https://www.amazon.com/Comfy-Sweatshirt-Comfortable-Originally-Featured/dp/B07DKTDBWC?th=1> (Year: 2018).

* cited by examiner

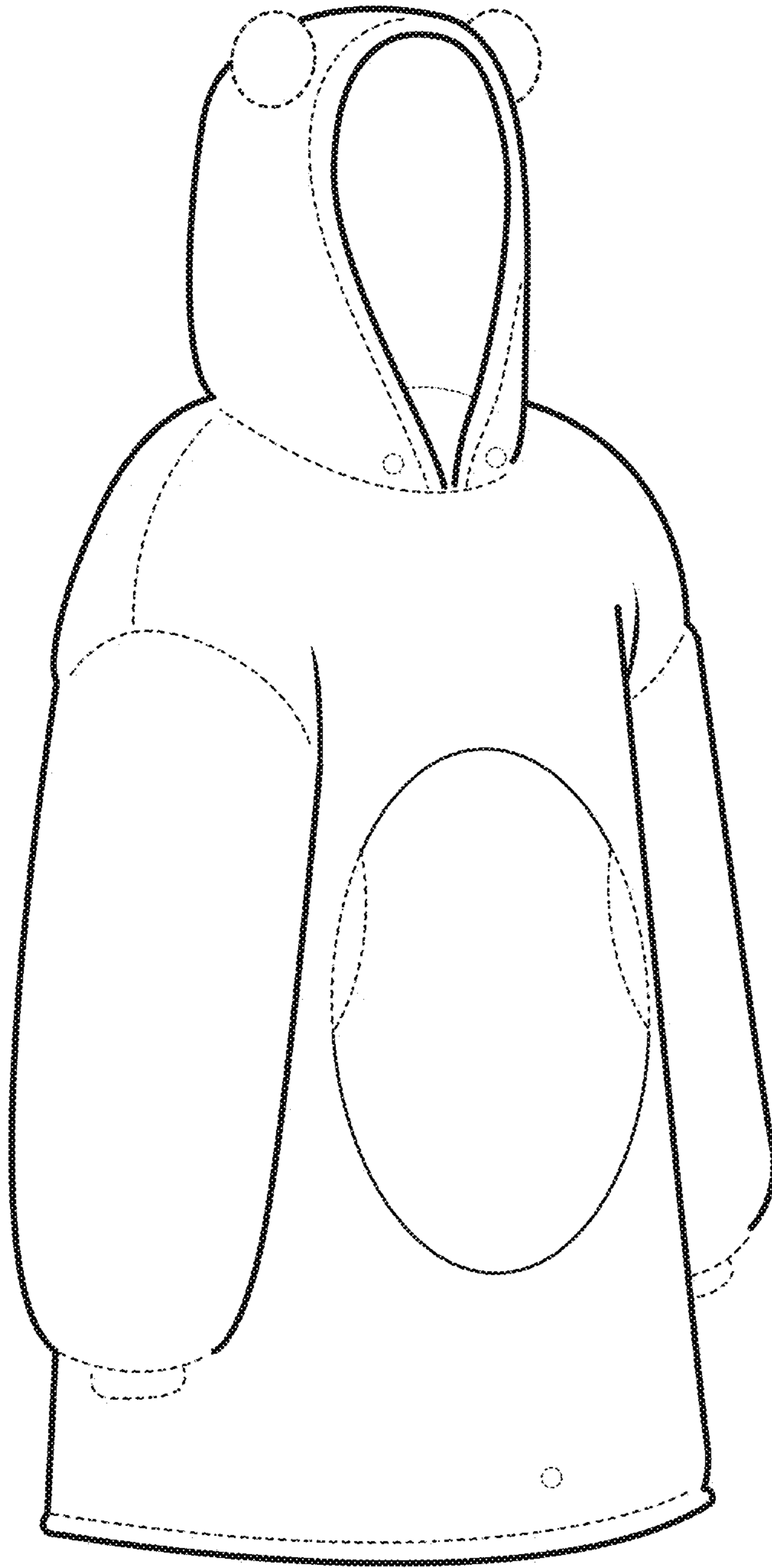

FIGURE 1

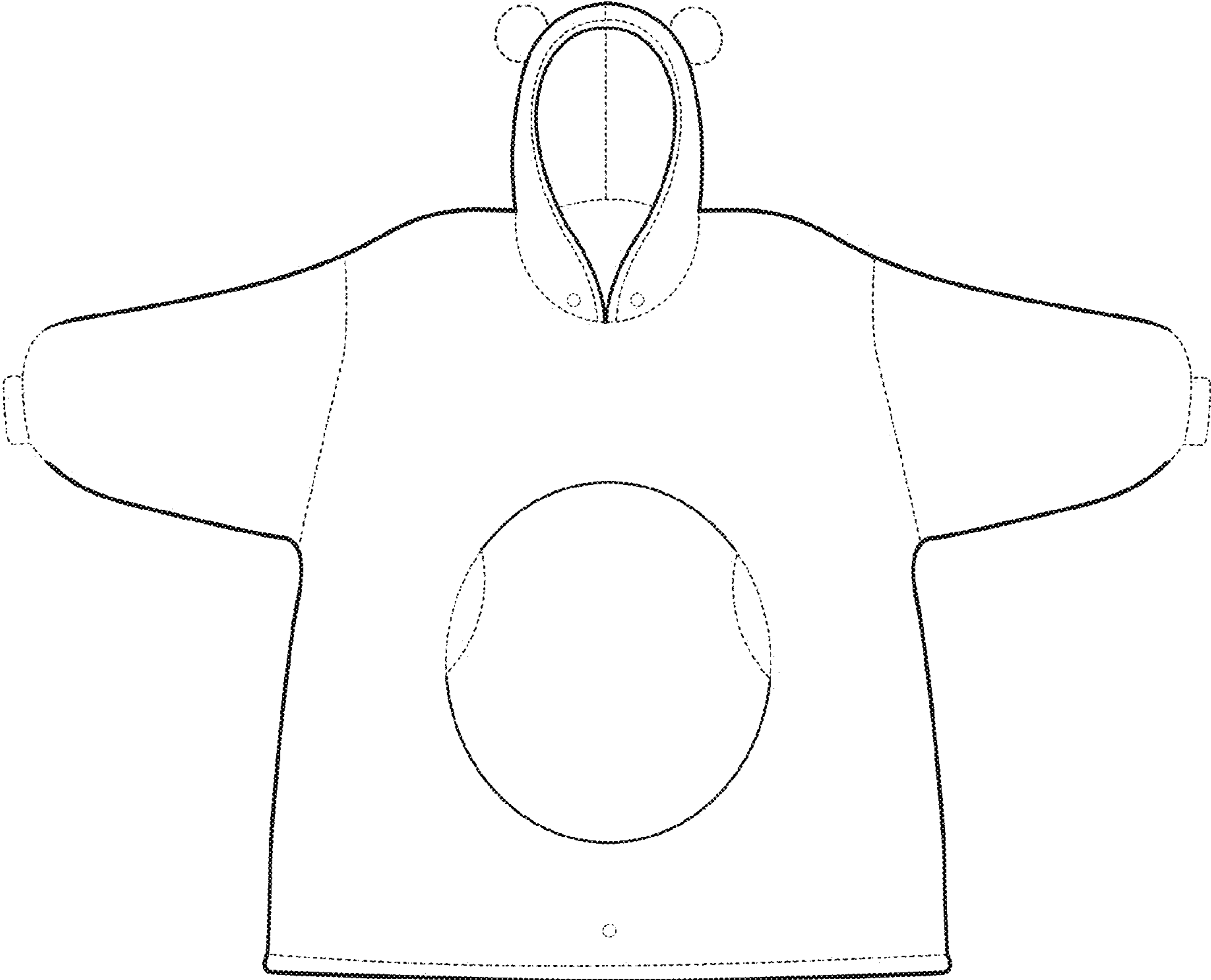

FIGURE 2

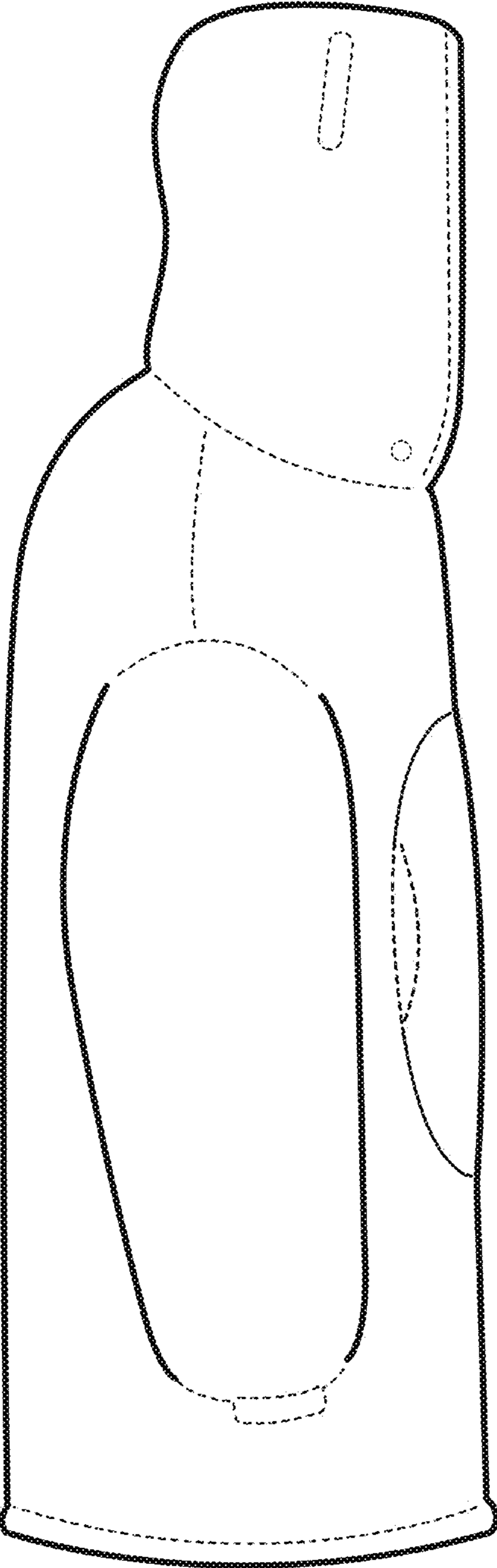

FIGURE 3

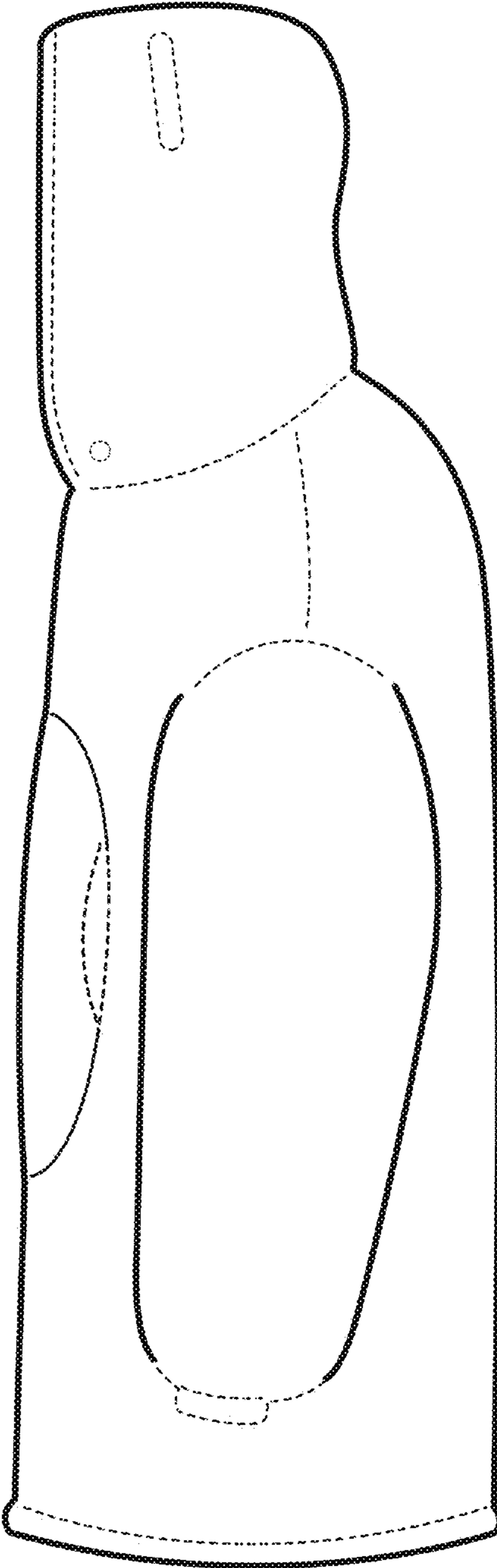

FIGURE 4

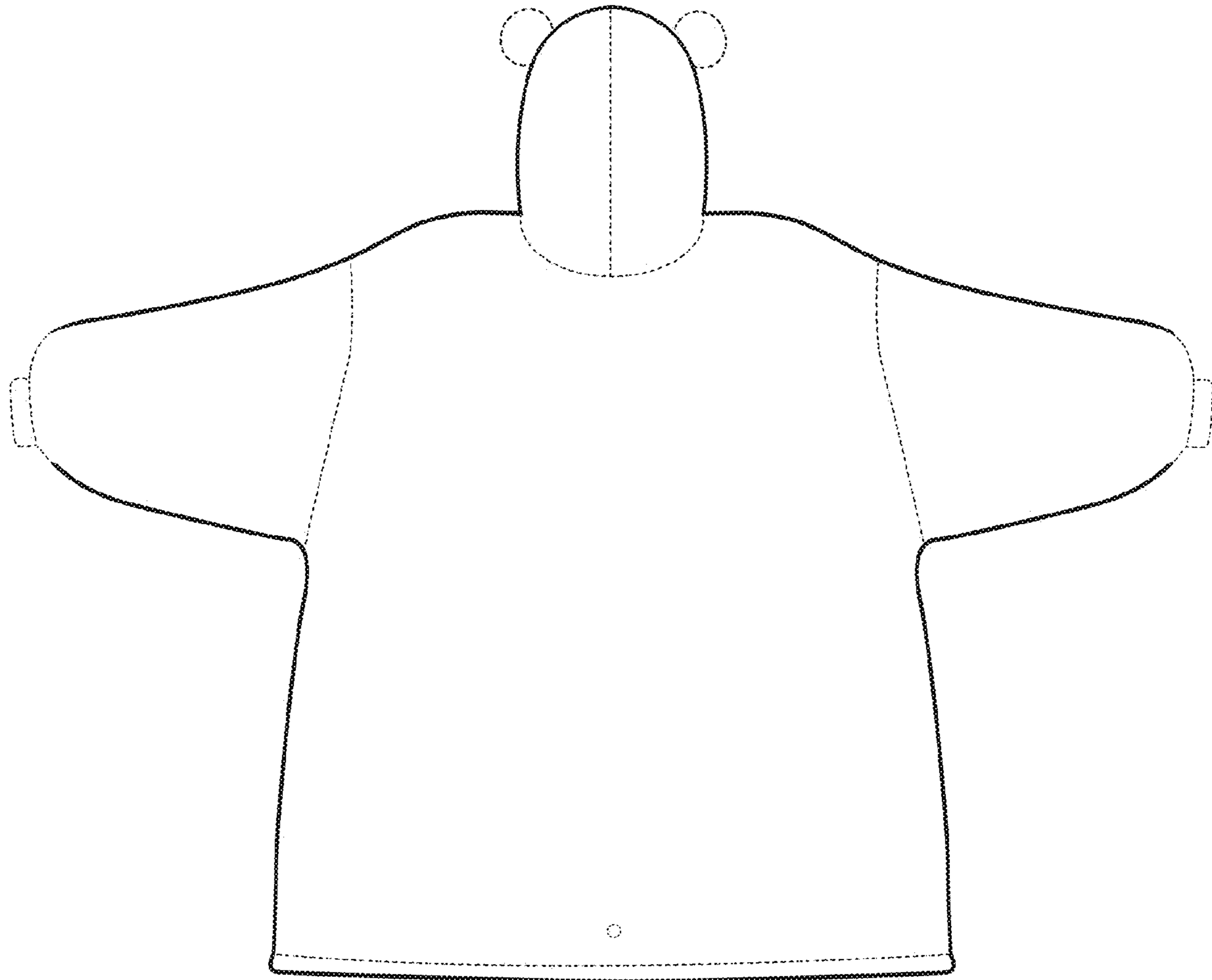

FIGURE 5

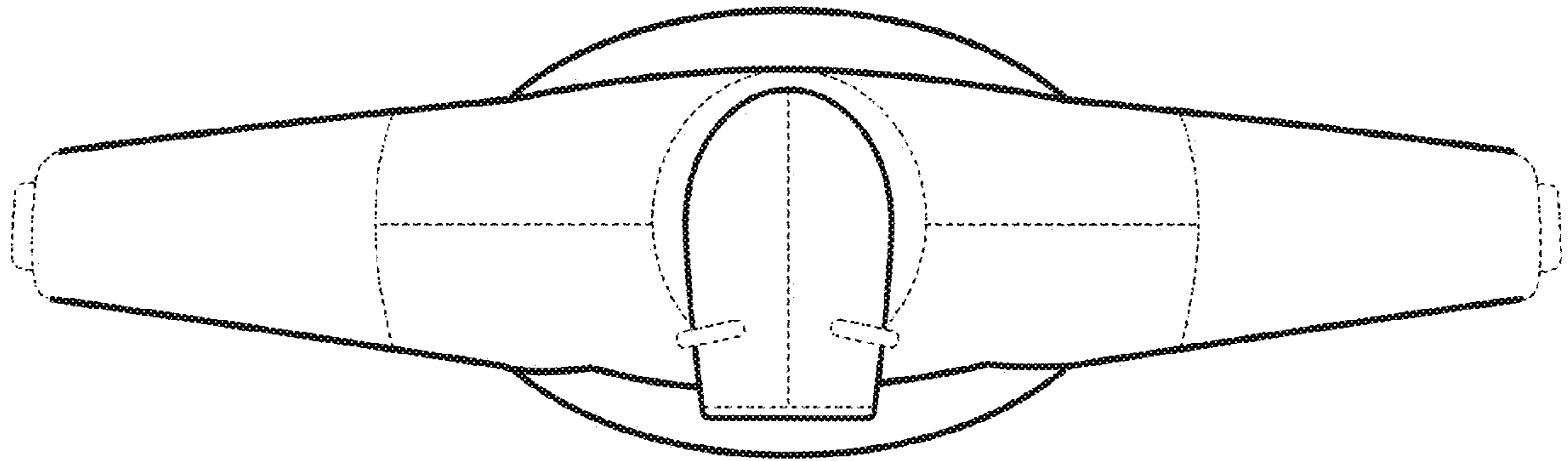

FIGURE 6

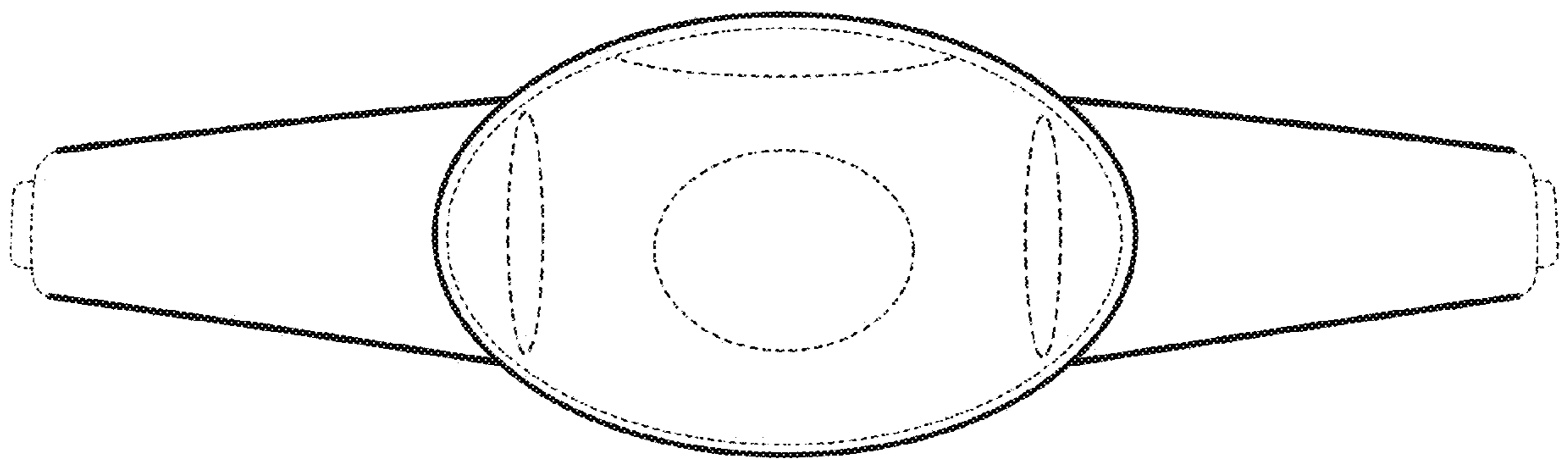

FIGURE 7

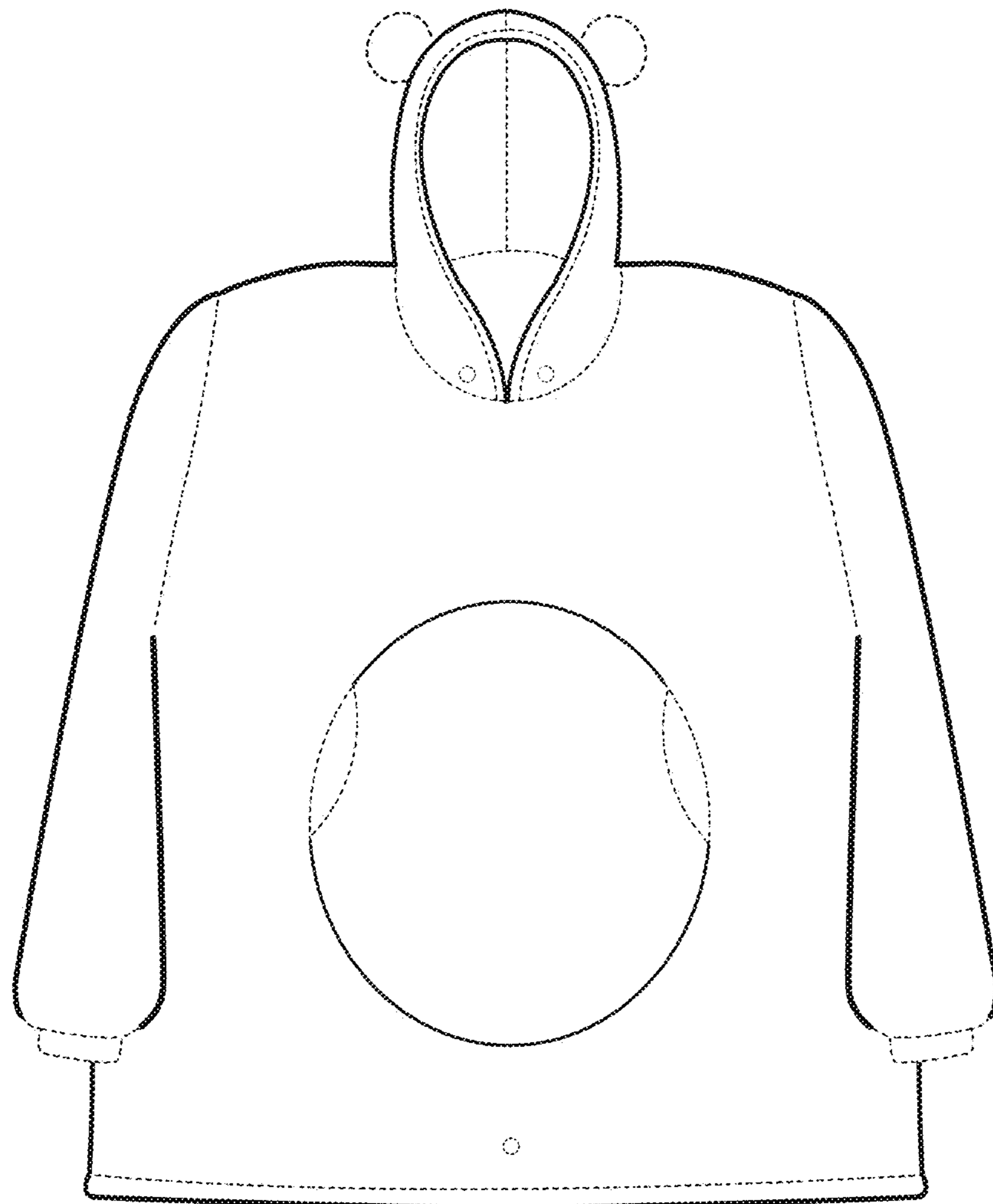

FIGURE 8

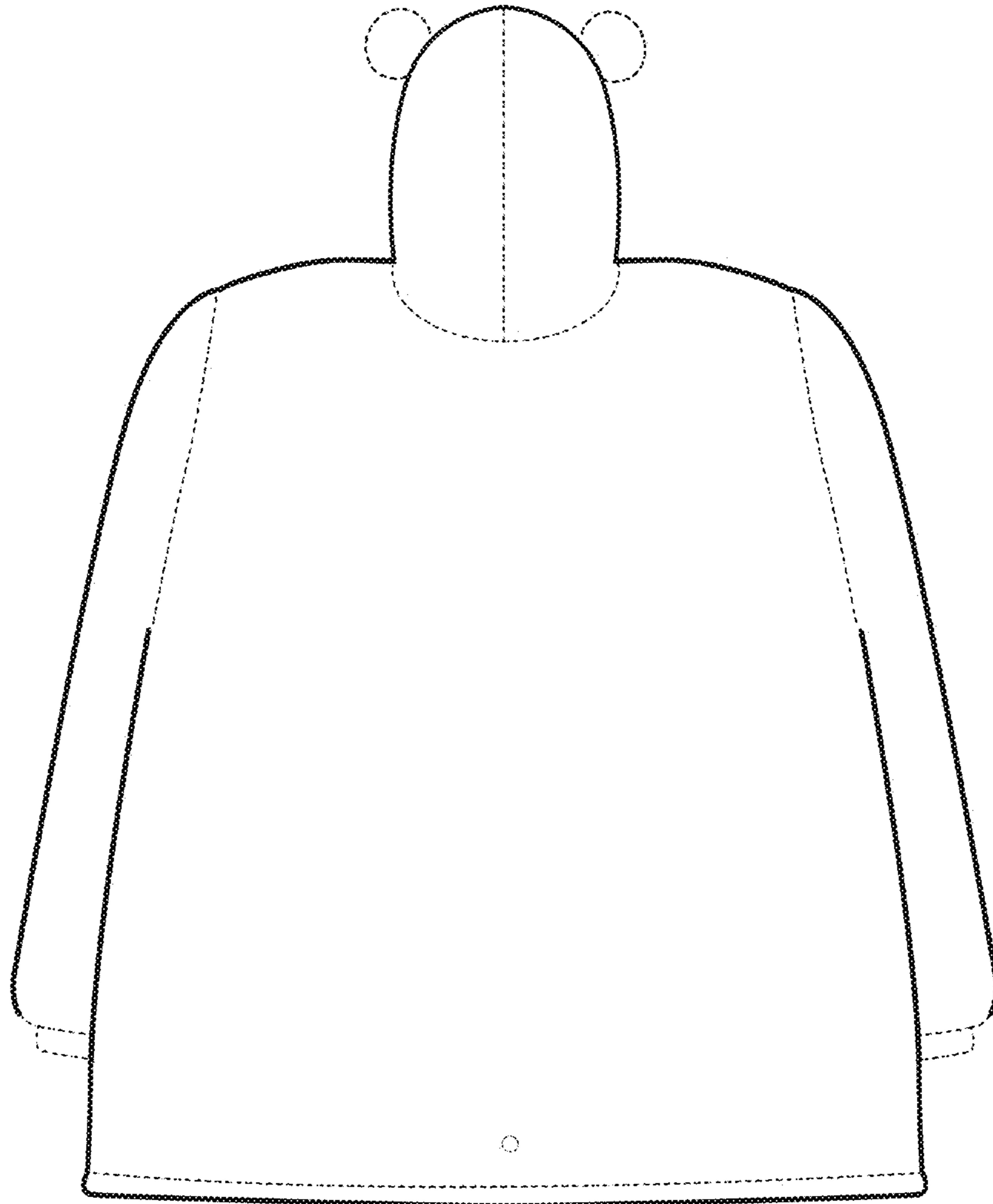

FIGURE 9