



US00D912233S

(12) **United States Design Patent**  
**Zhang et al.**

(10) **Patent No.:** **US D912,233 S**  
(45) **Date of Patent:** **\*\* Mar. 2, 2021**

- (54) **GAS STOVE TABLE**
- (71) Applicant: **Aukey Technology Co., Ltd**, Shenzhen (CN)
- (72) Inventors: **Weijun Zhang**, Shenzhen (CN);  
**Haizhuan Lu**, Shenzhen (CN)
- (73) Assignee: **Aukey Technology Co., Ltd**, Shenzhen (CN)
- (\*\*) Term: **15 Years**
- (21) Appl. No.: **29/720,790**
- (22) Filed: **Jan. 16, 2020**
- (51) **LOC (13) Cl.** ..... **23-03**
- (52) **U.S. Cl.**  
USPC ..... **D23/332; D23/339**
- (58) **Field of Classification Search**  
USPC ..... D23/314, 317, 332, 336, 342–350, 329,  
D23/338, 339, 328, 334, 335, 341;  
D7/332, 334–337, 339, 341; D6/689,  
D6/691, 691.1, 685, 686, 688.12  
CPC .... F24C 7/105; F24C 1/10; F24C 3/04; F24C  
7/065; F23D 14/12; F24H 3/00; A47J  
2037/0777; A47J 37/0763; F24B 3/00;  
F24B 1/195; F24B 1/00; F24B 13/00;  
F24B 1/18; F24B 13/004; F24B 1/192;  
F24B 1/181; F24B 1/182; F24B 1/1802  
See application file for complete search history.

- 10,240,796 B1 \* 3/2019 Stilwell ..... F24B 1/191
- D848,591 S \* 5/2019 O'Brien Wheeler ..... D23/343
- D857,865 S \* 8/2019 Wang ..... D23/339
- D901,651 S \* 11/2020 Wang ..... D23/332
- 2017/0261210 A1 \* 9/2017 Harris ..... F24C 3/08
- 2019/0301739 A1 \* 10/2019 Dobias ..... F24C 5/08
- 2020/0191407 A1 \* 6/2020 Zemel ..... F24B 1/192

**OTHER PUBLICATIONS**

Amazon FIXKIT 30" Propane Fire Pit Table, 50,000 BTU Auto-Ignition Gas Fire Table [https://www.amazon.com/FIXKIT-Auto-Ignition-Waterproof-Certification-Fireplace/dp/B083R9K4HT/ref=sr\\_1\\_32?dchild=1&keywords=wicker+gas+table&qid=1609047105&sr=8-32](https://www.amazon.com/FIXKIT-Auto-Ignition-Waterproof-Certification-Fireplace/dp/B083R9K4HT/ref=sr_1_32?dchild=1&keywords=wicker+gas+table&qid=1609047105&sr=8-32) (Year: 2020).\*

(Continued)

*Primary Examiner* — Ania Aman  
(74) *Attorney, Agent, or Firm* — Westbridge IP LLC

(57) **CLAIM**

The ornamental design for a gas stove table, as shown and described.

**DESCRIPTION**

FIG. 1 is front, right, and top side perspective view of a gas stove table showing our new design;  
FIG. 2 is a rear, left, and bottom perspective view thereof;  
FIG. 3 is a front elevational view thereof;  
FIG. 4 is a rear elevational view thereof;  
FIG. 5 is a left side view thereof;  
FIG. 6 is a right side view thereof;  
FIG. 7 is a top plan view thereof;  
FIG. 8 is a bottom plan view thereof; and,  
FIG. 9 is an enlarged view of portion 9 in FIG. 1.  
The broken lines in the drawings illustrate the portions of the gas stove table which form no part of the claimed design.

**1 Claim, 9 Drawing Sheets**

- (56) **References Cited**  
U.S. PATENT DOCUMENTS  
3,491,744 A \* 1/1970 von Kohorn et al. ....  
A47J 37/0781  
126/25 R  
D233,499 S \* 11/1974 Sakata ..... D6/686  
D698,908 S \* 2/2014 Krieger ..... D23/314

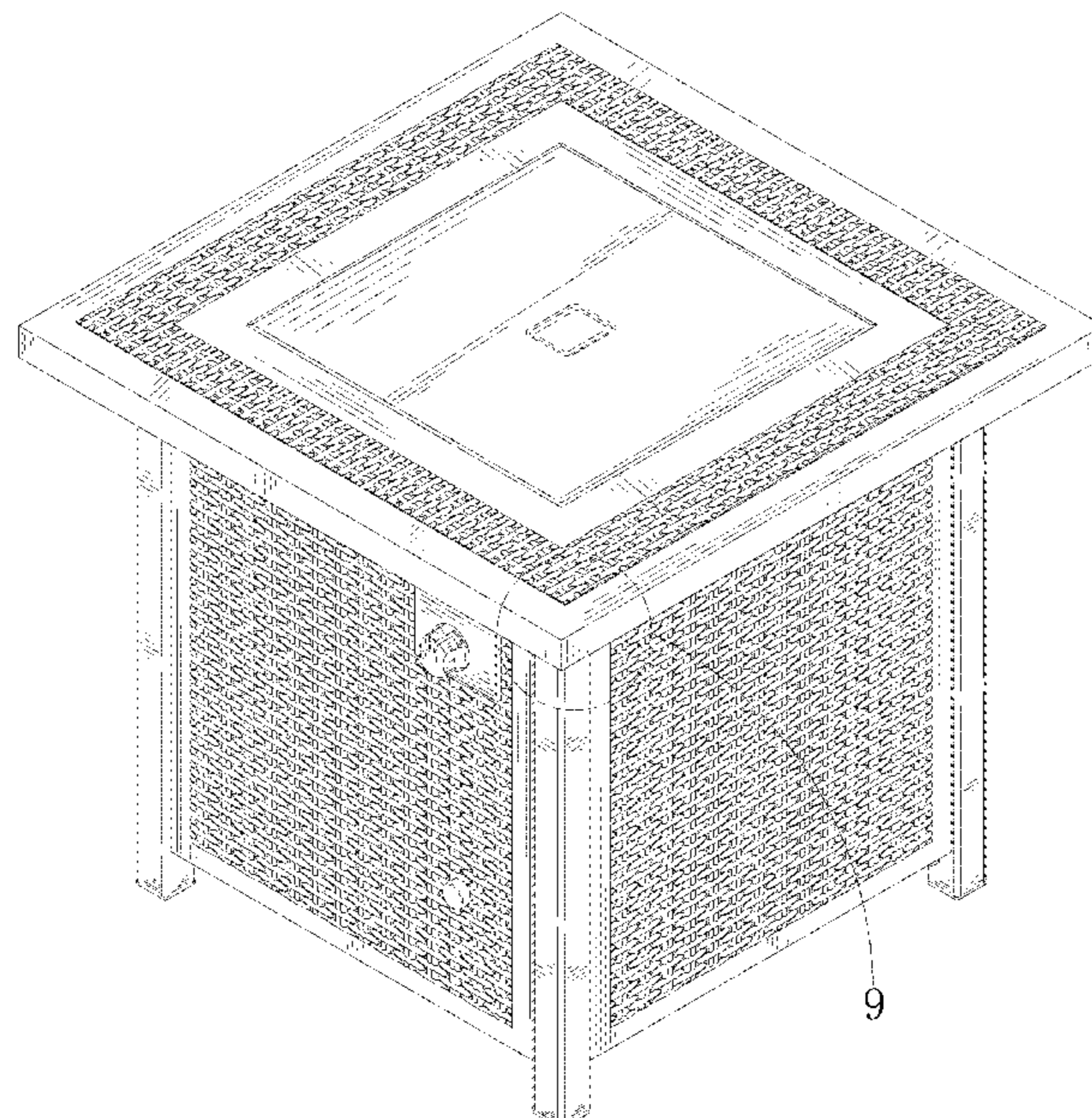

(56)

**References Cited**

OTHER PUBLICATIONS

Amazon TACKLIFE Propane Fire Pit Table, Outdoor Companion, 28 Inch 50,000 BTU Auto-Ignition Gas Fire Pit Table [https://www.amazon.com/TACKLIFE-Auto-Ignition-Certification-Approval-Tabletop/dp/B07LG5Q78Q/ref=psdc\\_10044115011\\_t2\\_B083R9K4HT](https://www.amazon.com/TACKLIFE-Auto-Ignition-Certification-Approval-Tabletop/dp/B07LG5Q78Q/ref=psdc_10044115011_t2_B083R9K4HT) (Year: 2020).\*

Amazon TACKLIFE Propane Fire Pit Table [https://www.amazon.com/TACKLIFE-Surface-Outdoor-Certification-Approval/dp/B07ZB9NG9R/ref=sr\\_1\\_22\\_sspa?dchild=1&hvadid=77859282155319&hvbm=bp&hvdev=c&hvqmt=p&keywords=tacklife%2Bpropane%2Bfire%2Bpit%2Btable&qid=1609087163&sr=8-22-spons&tag=mh0b-20&spLa=ZW](https://www.amazon.com/TACKLIFE-Surface-Outdoor-Certification-Approval/dp/B07ZB9NG9R/ref=sr_1_22_sspa?dchild=1&hvadid=77859282155319&hvbm=bp&hvdev=c&hvqmt=p&keywords=tacklife%2Bpropane%2Bfire%2Bpit%2Btable&qid=1609087163&sr=8-22-spons&tag=mh0b-20&spLa=ZW) (Year: 2020).\*

\* cited by examiner

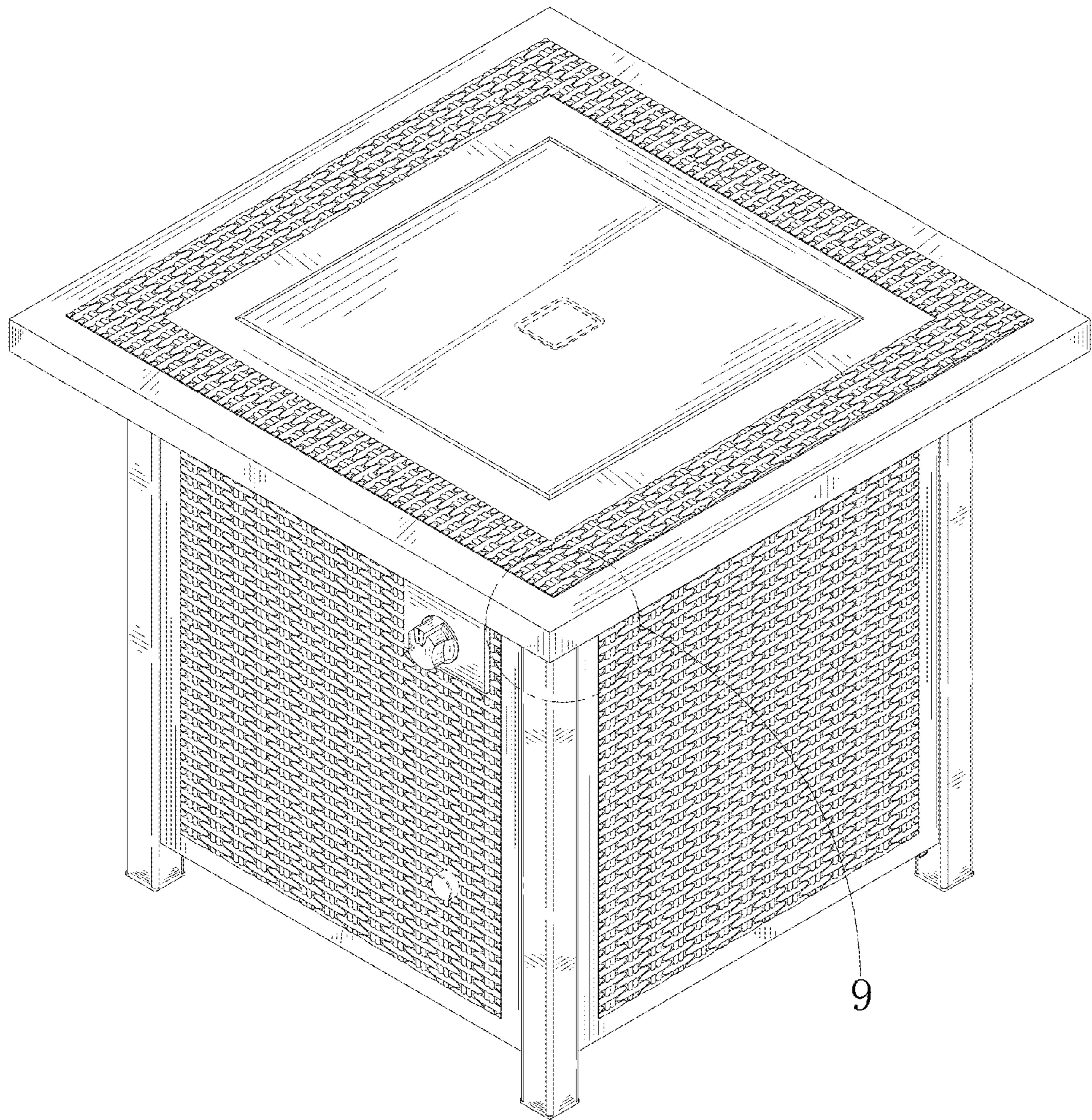

FIG. 1

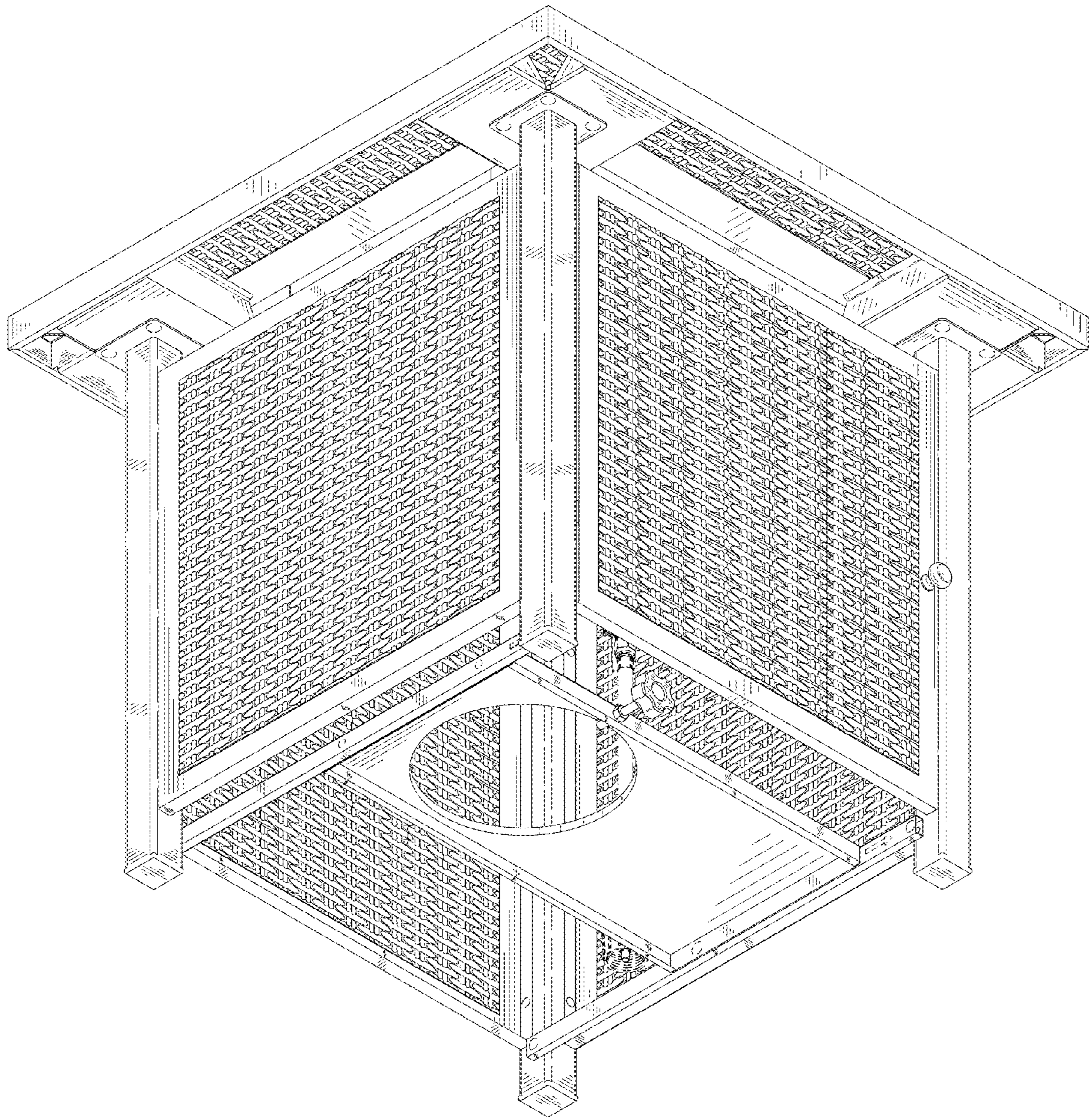

FIG. 2

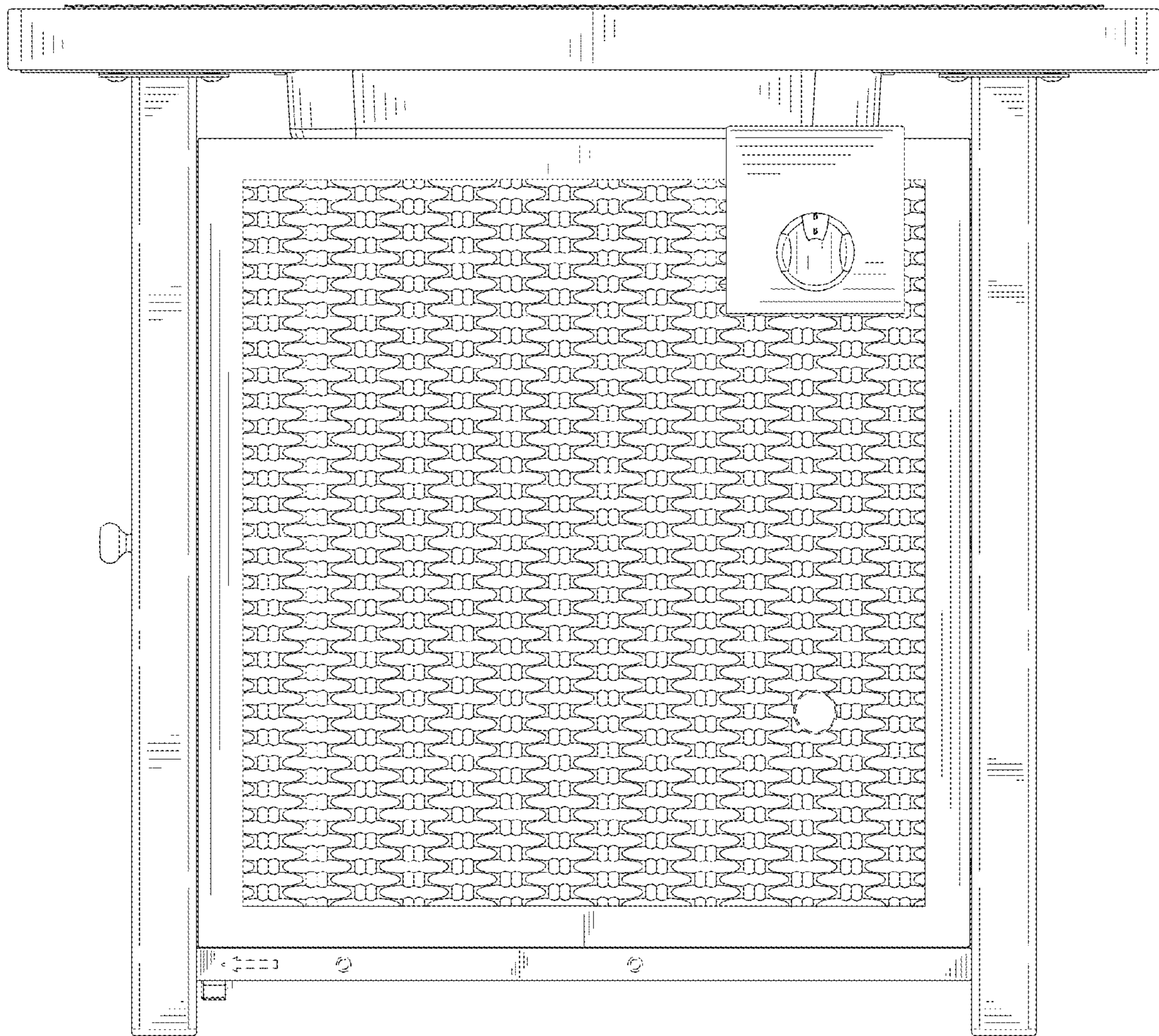

FIG. 3

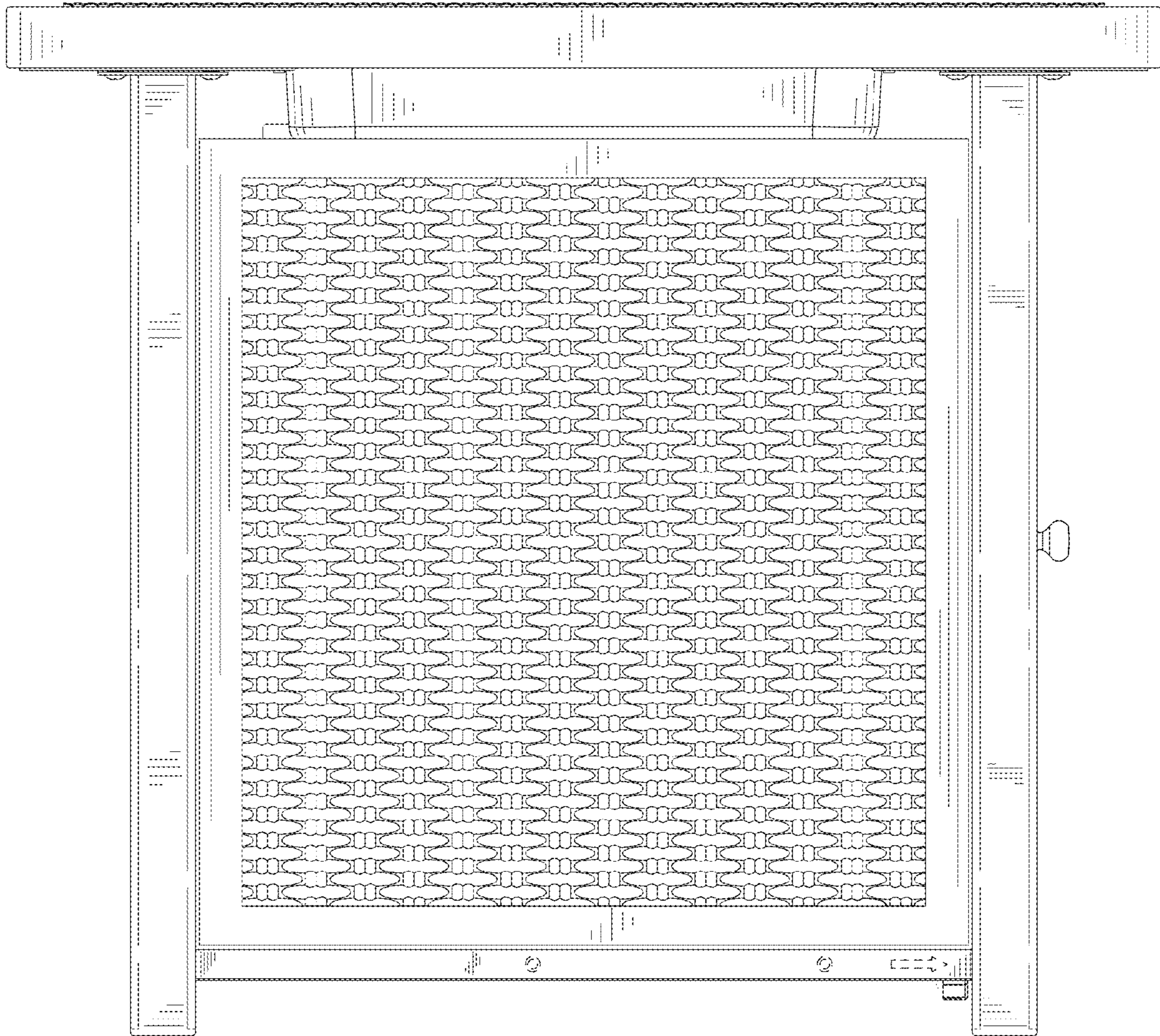

FIG. 4

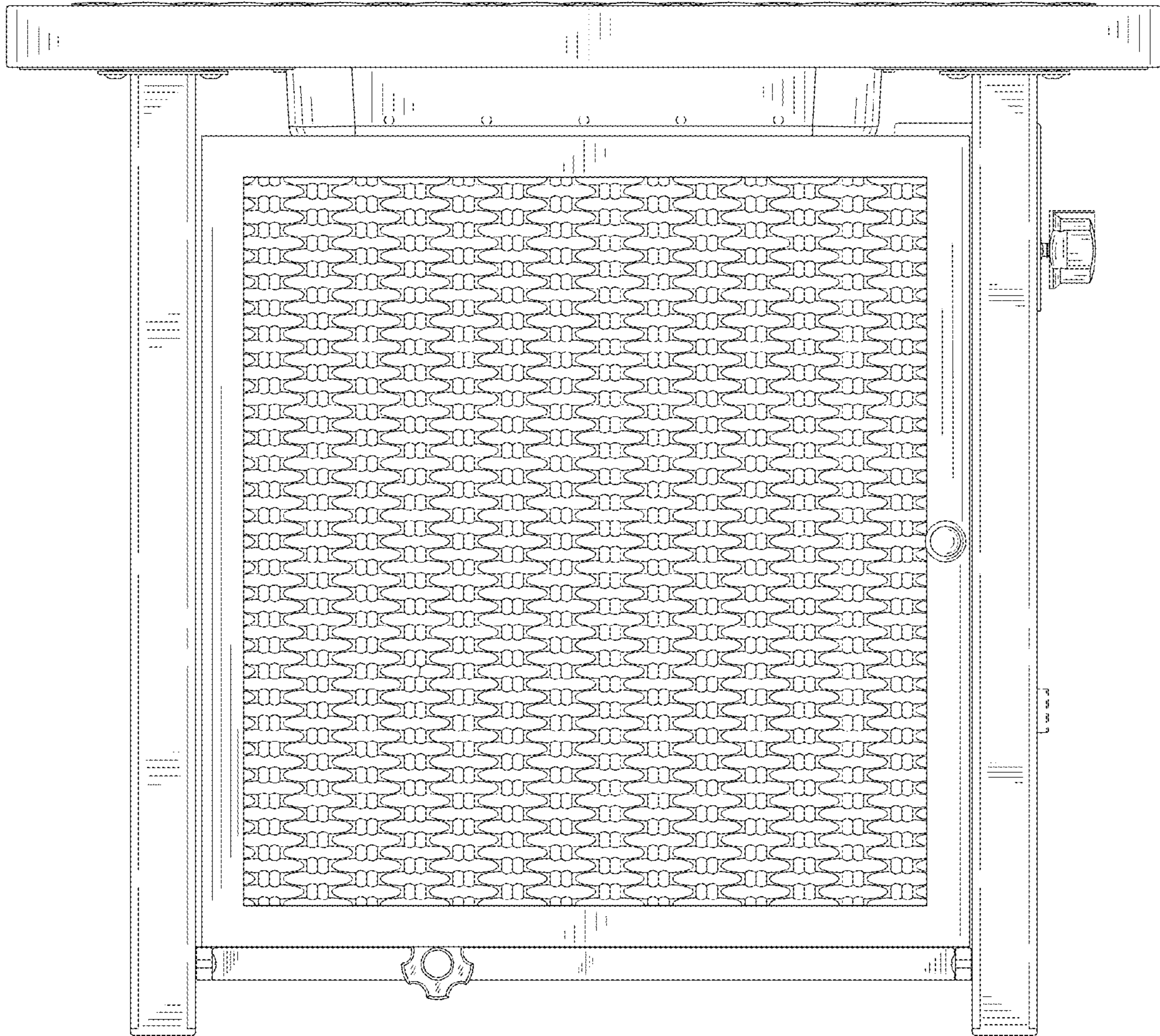

FIG. 5

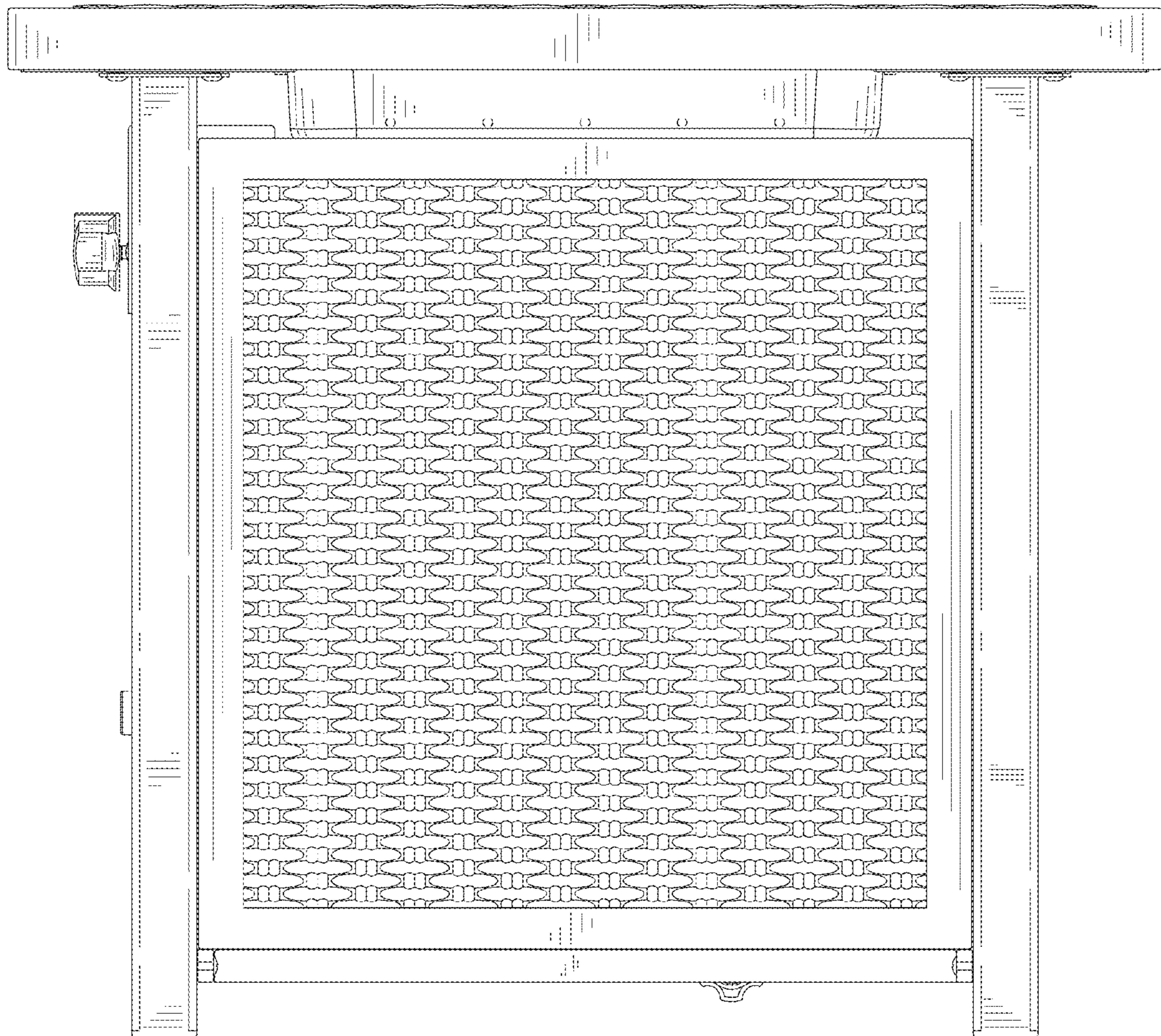

FIG. 6



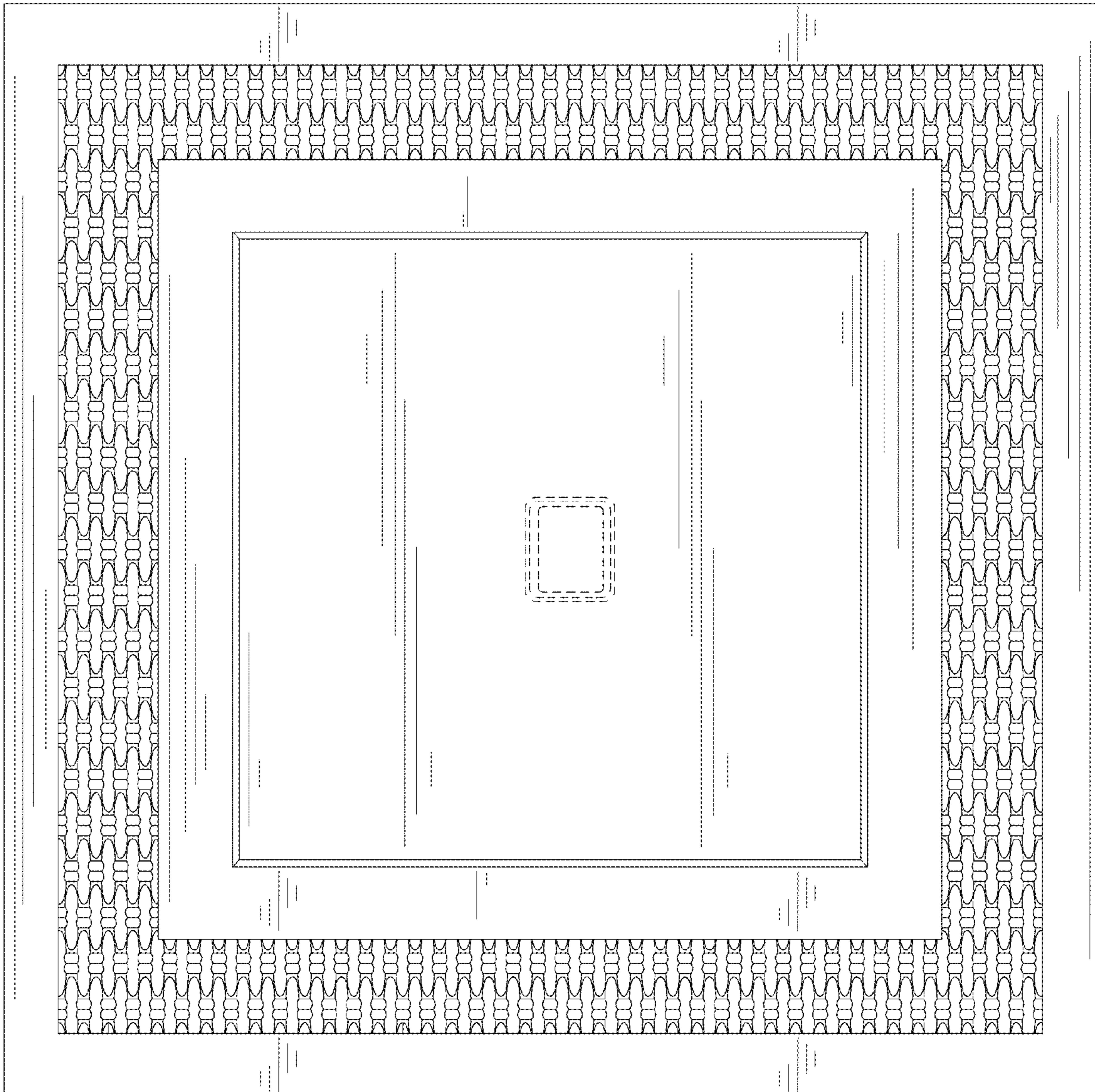

FIG. 7

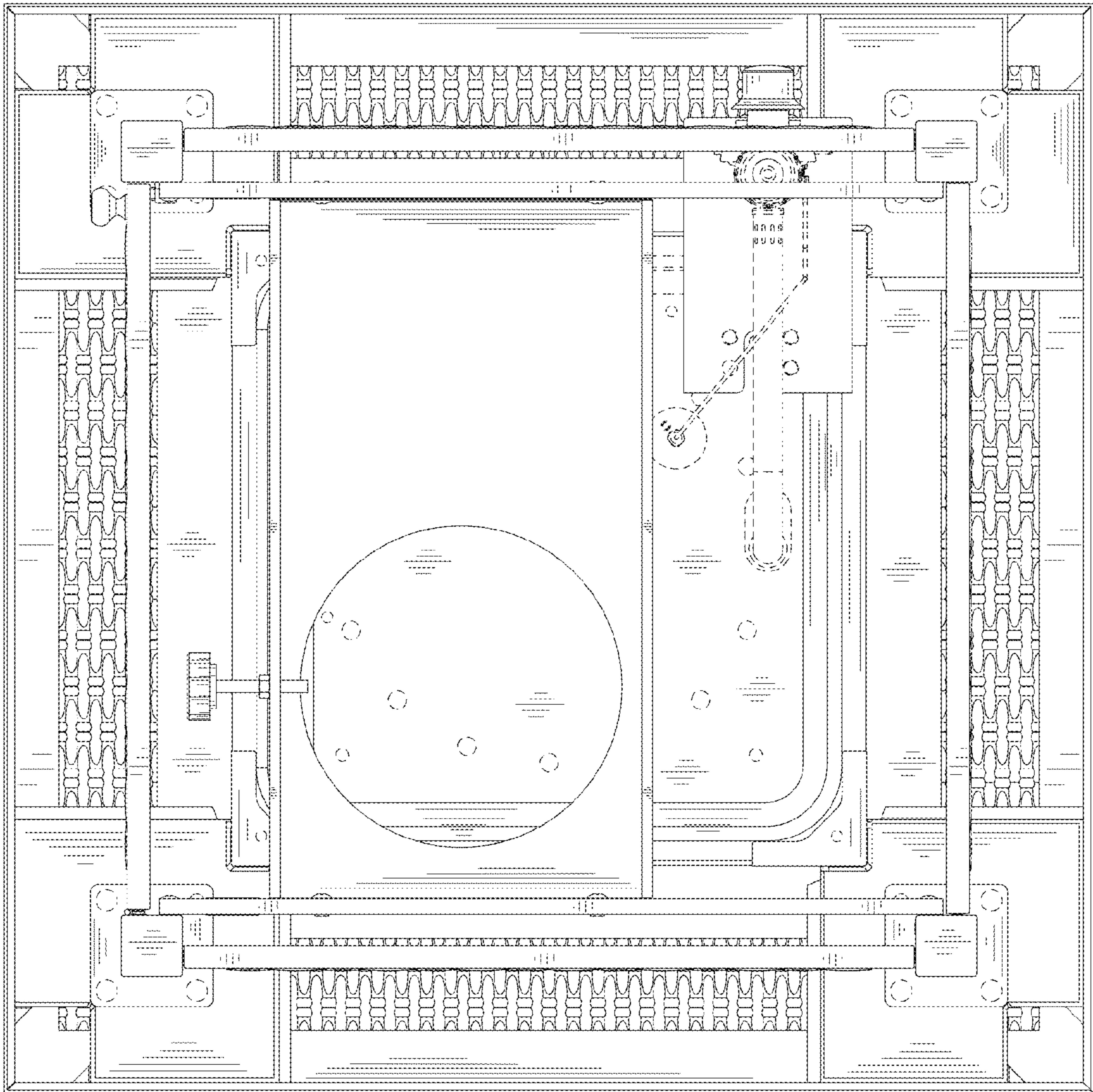

FIG. 8

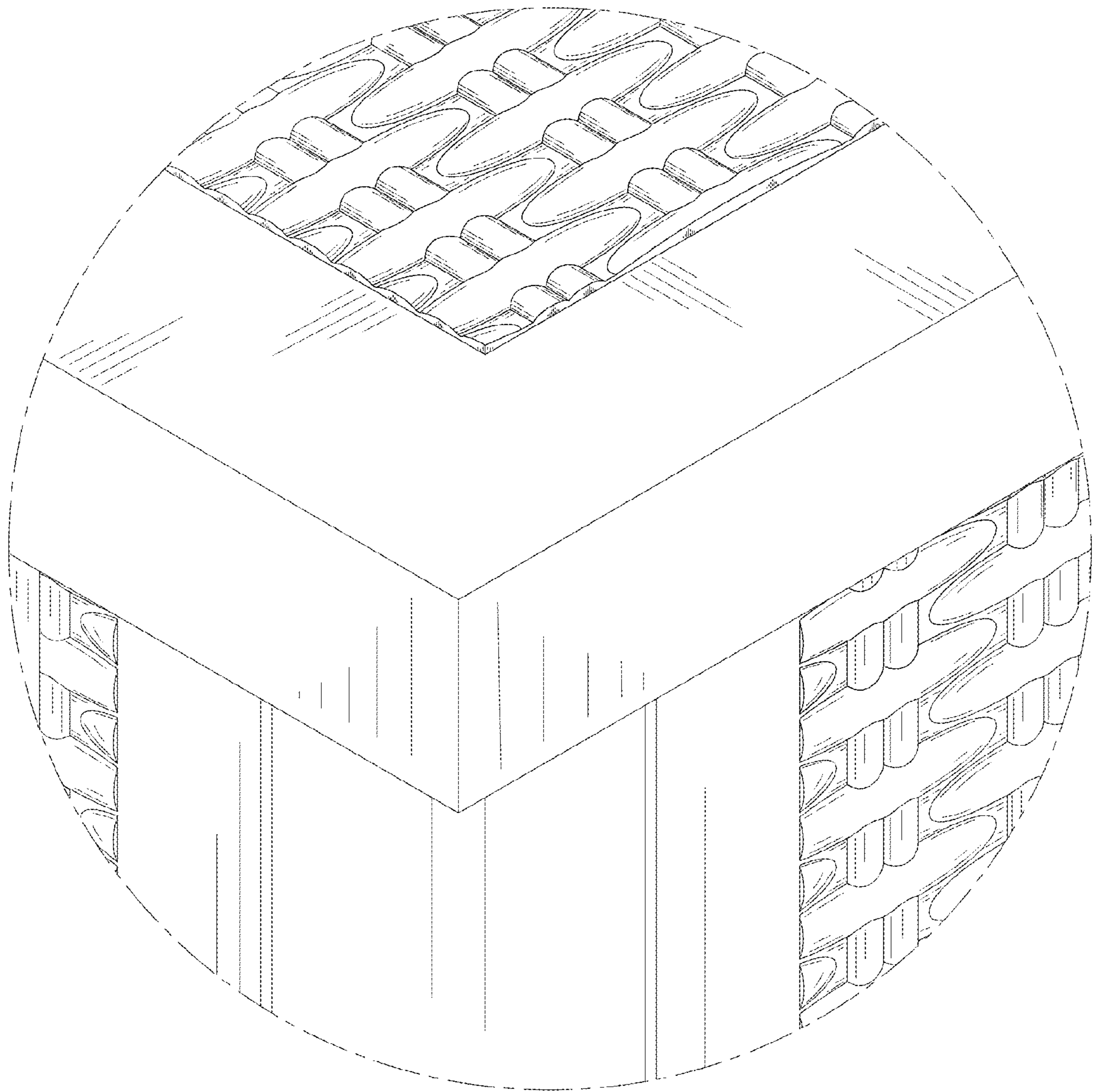

FIG. 9