



US00D912181S

(12) **United States Design Patent**
Han

(10) **Patent No.:** **US D912,181 S**
(45) **Date of Patent:** **** Mar. 2, 2021**

(54) **ELECTRIC SKATEBOARD**

(71) Applicant: **Shenzhen Dongboshi Technology Co., Ltd.**, Shenzhen (CN)

(72) Inventor: **Xiaodong Han**, Shenzhen (CN)

(73) Assignee: **Shenzhen Dongboshi Technology Co., Ltd.**, Shenzhen (CN)

(**) Term: **15 Years**

(21) Appl. No.: **29/715,539**

(22) Filed: **Dec. 3, 2019**

(30) **Foreign Application Priority Data**

Oct. 9, 2019 (CN) 201930548115.8

(51) **LOC (13) Cl.** **21-02**

(52) **U.S. Cl.**
USPC **D21/765**

(58) **Field of Classification Search**
USPC D21/419, 421, 423, 760, 763, 765, 771;
D12/1
CPC . A63C 17/0001; A63C 17/011; A63C 17/012;
A63C 17/013; A63C 17/014; A63C
17/015; A63C 17/017; A63C 2203/42
See application file for complete search history.

(56) **References Cited**

U.S. PATENT DOCUMENTS

D422,662 S * 4/2000 Edwards D21/765
D790,015 S * 6/2017 Tan D21/765

D798,407 S * 9/2017 Pang D21/765
D817,427 S * 5/2018 Pang D21/765
D818,070 S * 5/2018 Pang D21/765
D831,768 S * 10/2018 Andreasyan D21/765
D875,864 S * 2/2020 Cao D21/765
D887,511 S * 6/2020 Fu D21/765

* cited by examiner

Primary Examiner — Cynthia M. Chin

(74) *Attorney, Agent, or Firm* — ScienBiziP, P.C.

(57) **CLAIM**

The ornamental design for a electric skateboard, as shown and described.

DESCRIPTION

FIG. 1 is a bottom, front, right side perspective view of a electric skateboard, showing my design.
FIG. 2 is a top, rear, left side perspective view thereof.
FIG. 3 is a front elevation view thereof.
FIG. 4 is a rear elevation view thereof.
FIG. 5 is a left side elevation view thereof.
FIG. 6 is a right side elevation view thereof.
FIG. 7 is a top plan view thereof; and,
FIG. 8 is a bottom plan view thereof.
The broken lines are for the purpose of illustrating portions of the article that form no part of the claimed design.

1 Claim, 8 Drawing Sheets

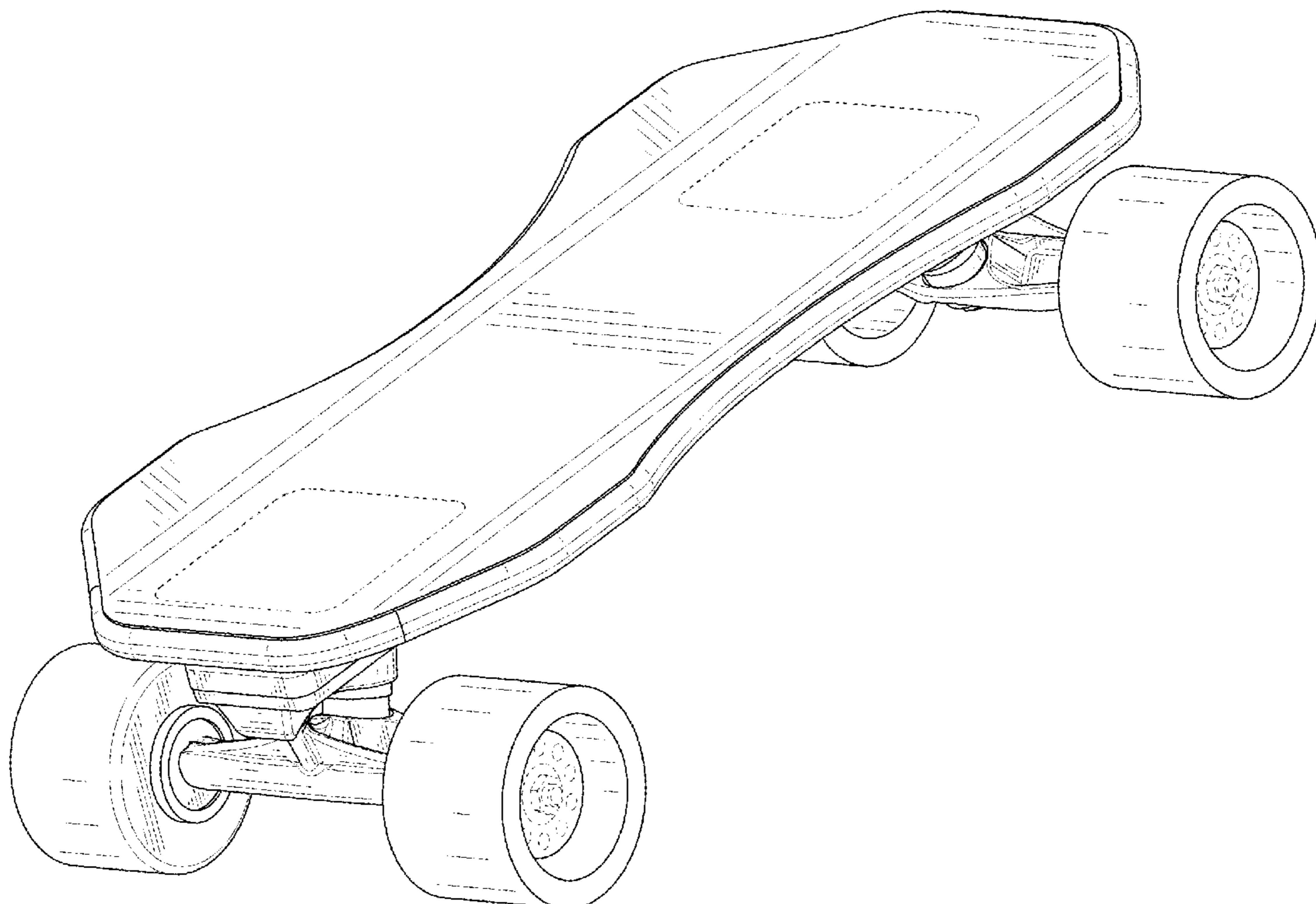

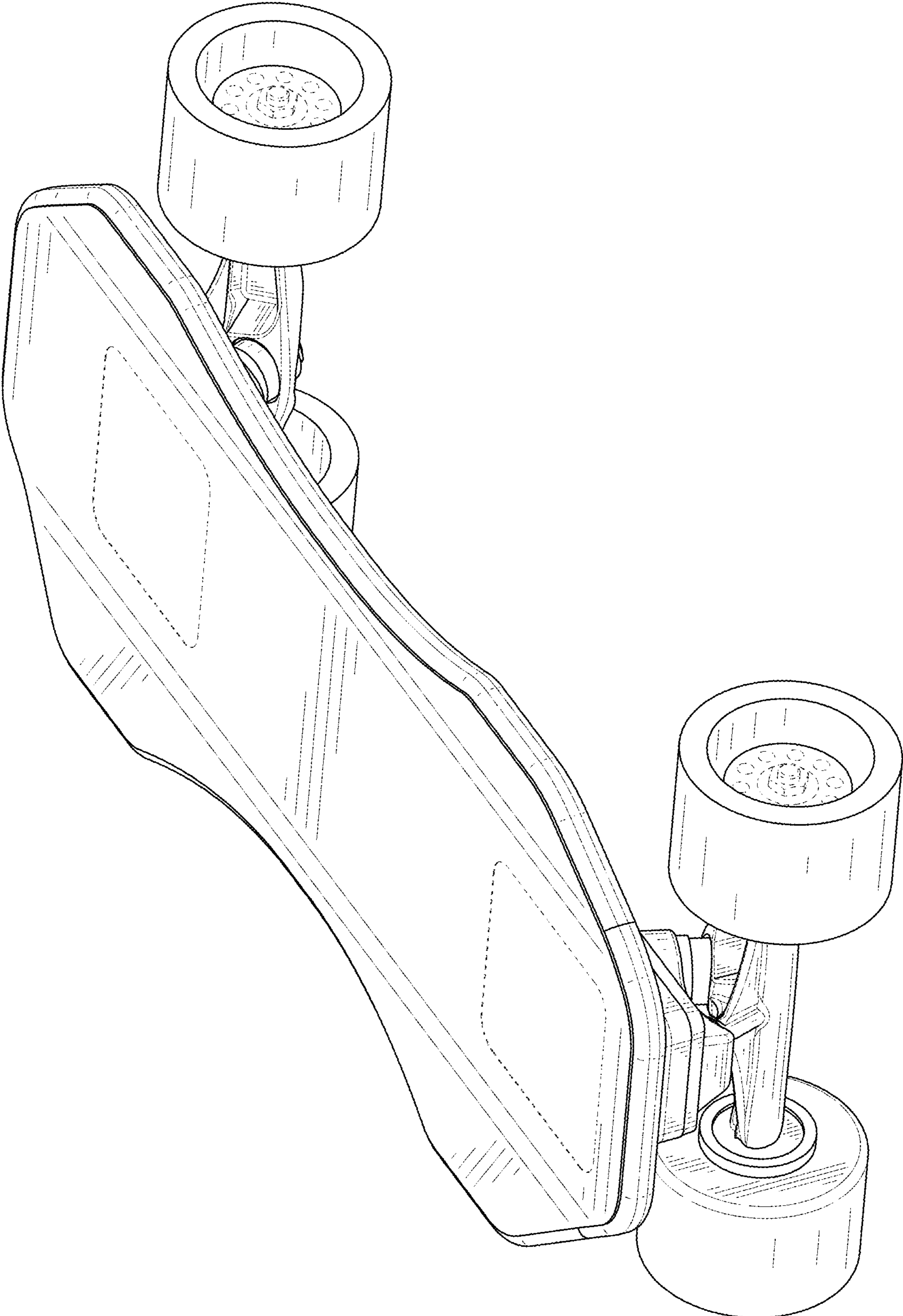

FIG. 1

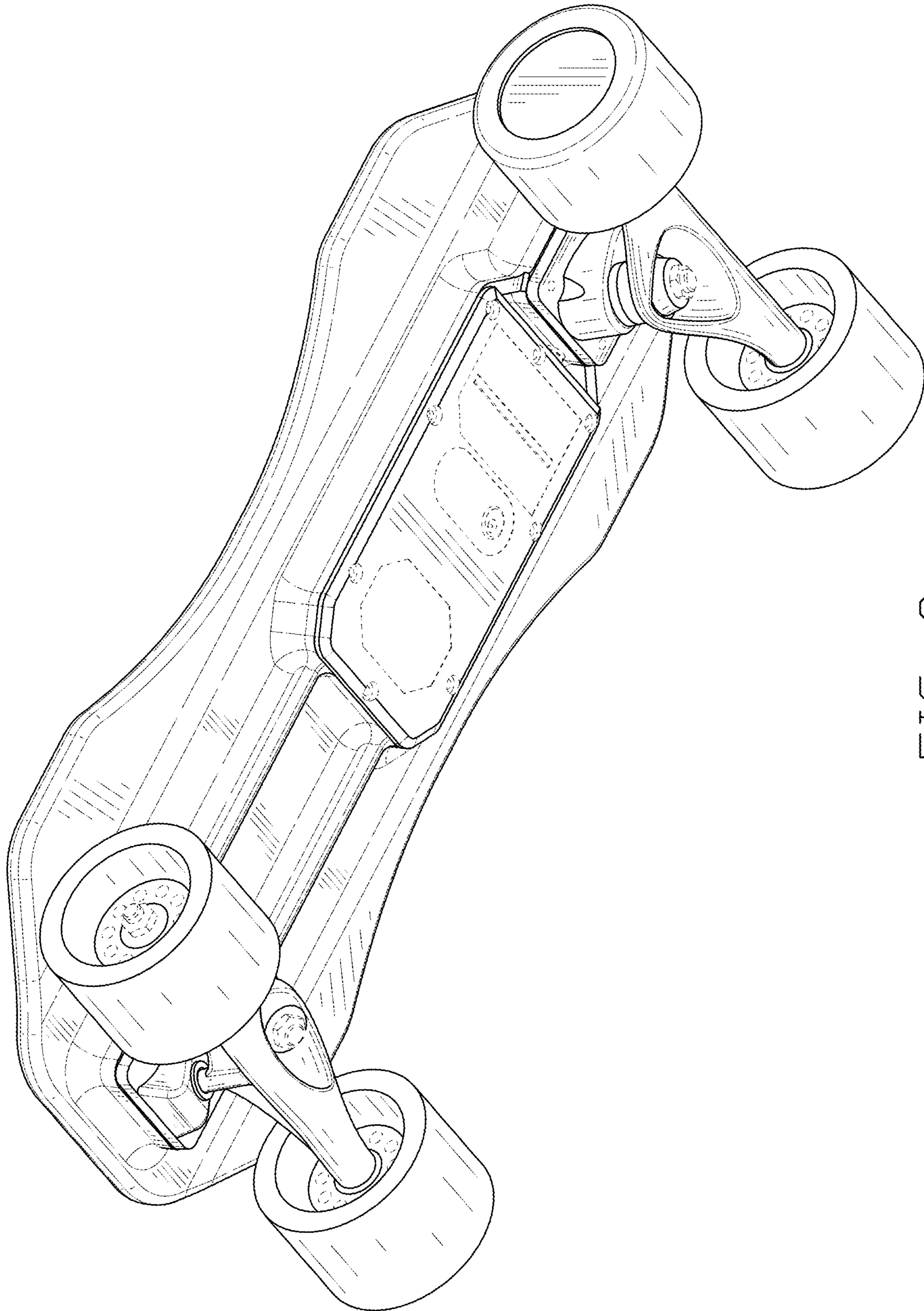

FIG. 2

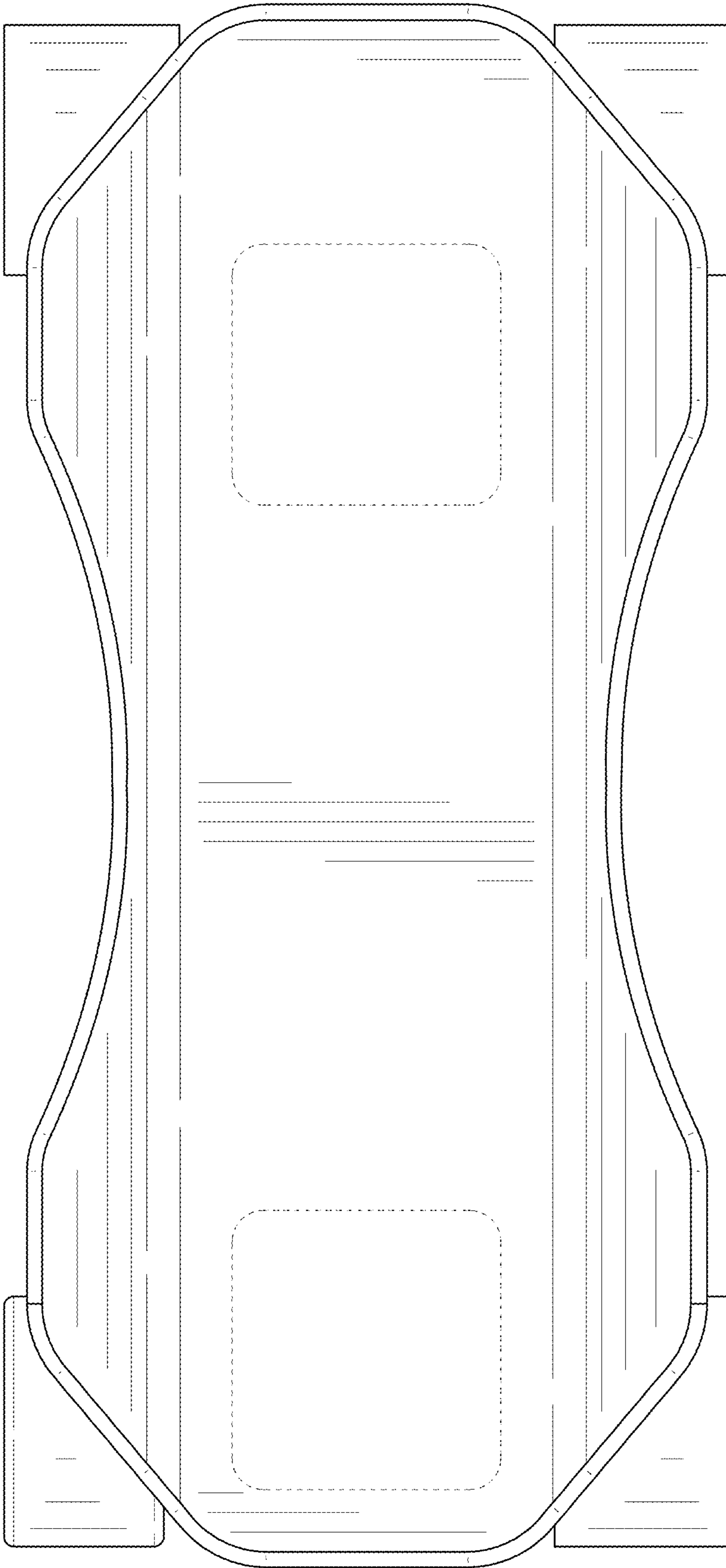

FIG. 3

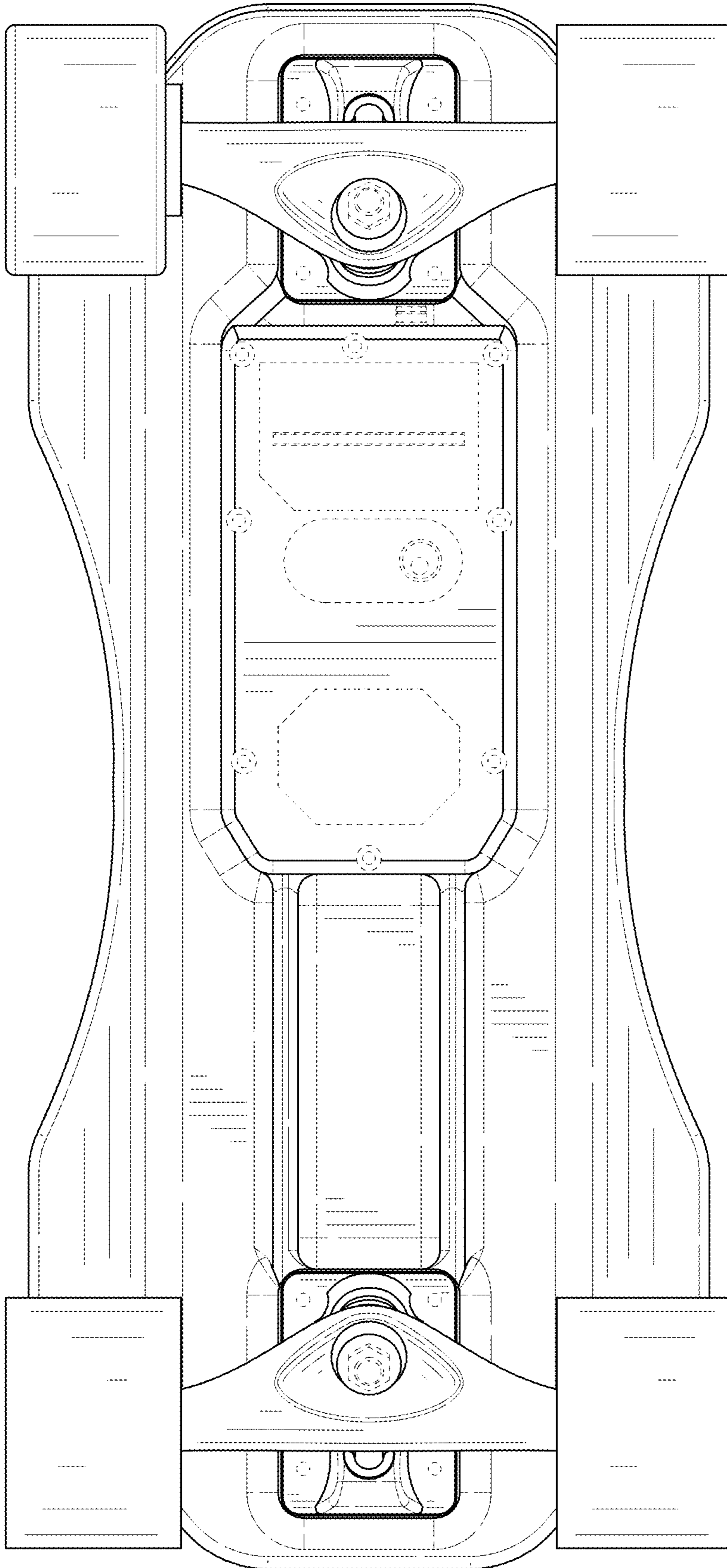

FIG. 4

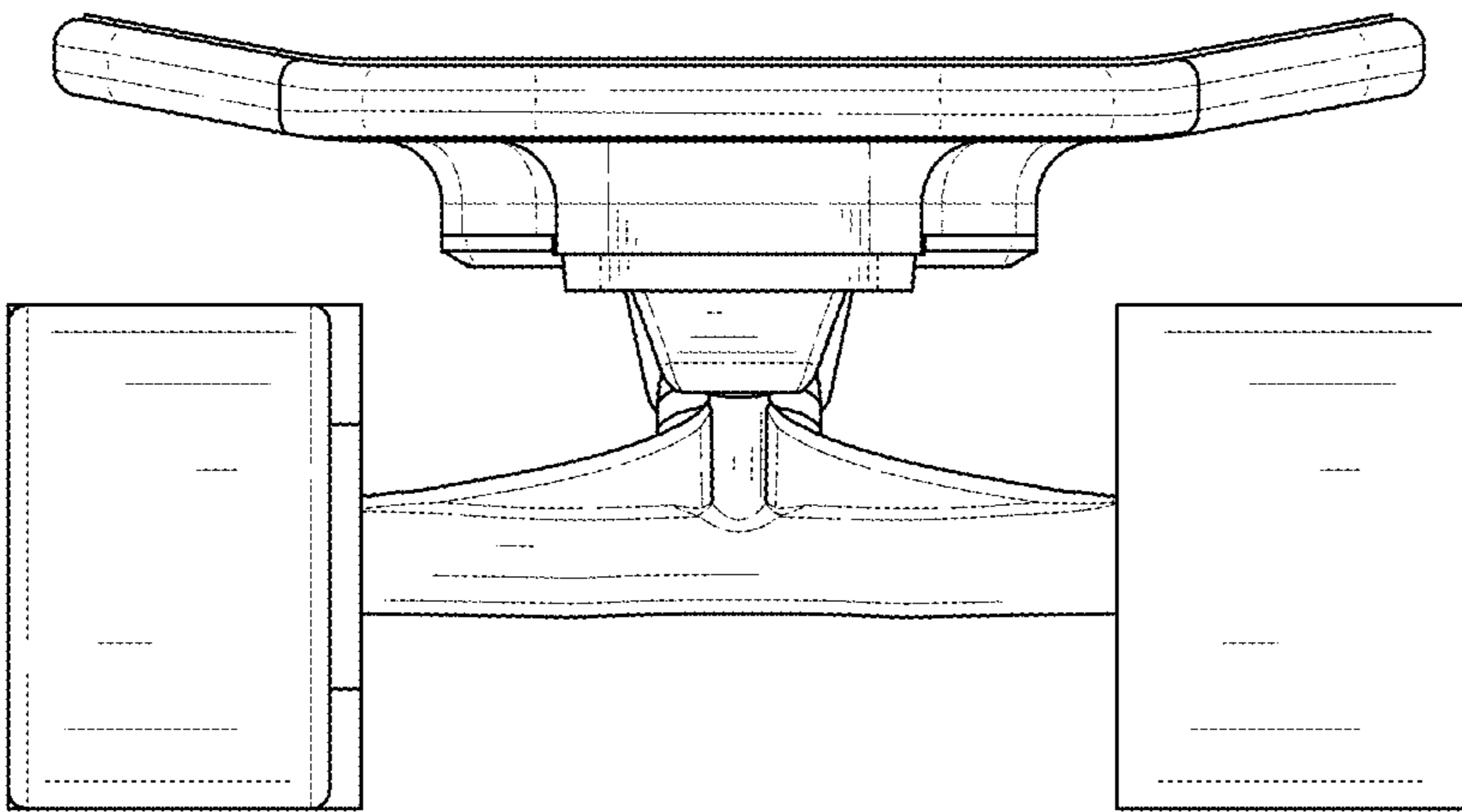

FIG. 5

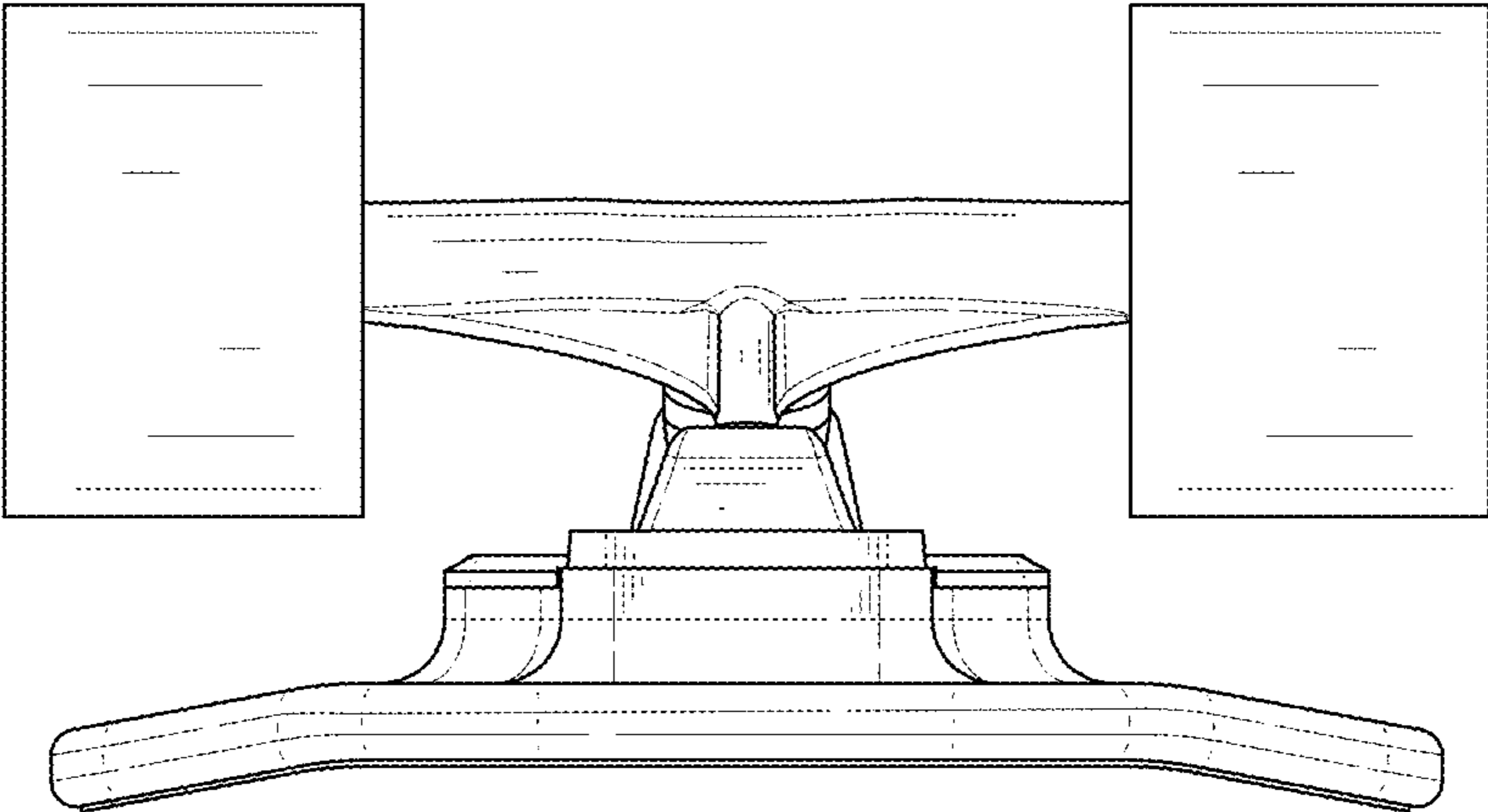

FIG. 6

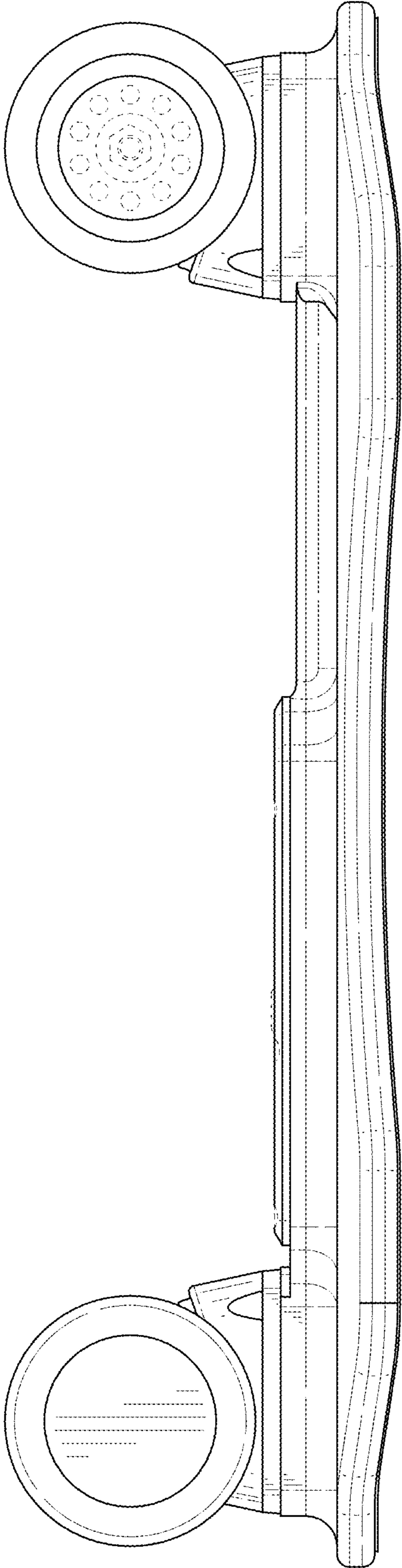

FIG. 7

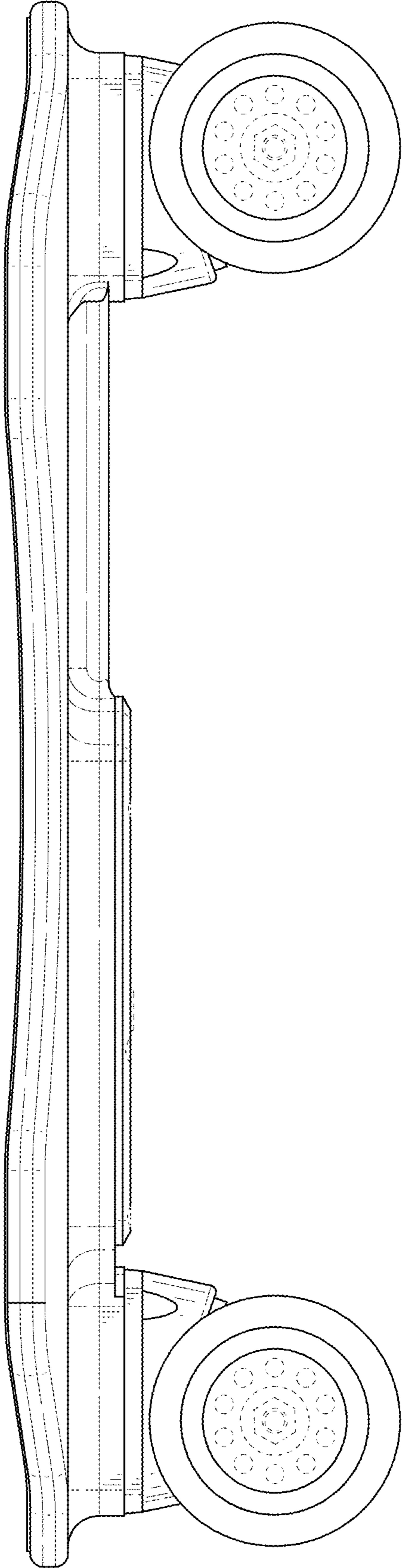

FIG. 8