



US00D912160S

(12) **United States Design Patent**  
**Muraki et al.**

(10) **Patent No.:** **US D912,160 S**

(45) **Date of Patent:** **\*\* Mar. 2, 2021**

(54) **ACCESSORY FOR SPINNING TOP TOY**  
(71) Applicant: **TOMY COMPANY, LTD.**, Tokyo (JP)  
(72) Inventors: **Makoto Muraki**, Tokyo (JP); **Hiroyuki Matsukawa**, Tokyo (JP)  
(73) Assignee: **TOMY COMPANY, LTD.**, Tokyo (JP)  
(\*\*) Term: **15 Years**

D667,894 S \* 9/2012 Horikoshi ..... D21/460  
D820,919 S \* 6/2018 Horikoshi ..... D21/460  
D825,007 S \* 8/2018 Muraki ..... D21/460  
D825,673 S \* 8/2018 Matsukawa ..... D21/460  
D825,676 S \* 8/2018 Horikoshi ..... D21/461  
D827,043 S \* 8/2018 Muraki ..... D21/460  
D827,044 S \* 8/2018 Horikoshi ..... D21/460  
D827,045 S \* 8/2018 Horikoshi ..... D21/460  
D827,046 S \* 8/2018 Horikoshi ..... D21/460  
D828,456 S \* 9/2018 Muraki ..... D21/460

(Continued)

(21) Appl. No.: **29/714,415**  
(22) Filed: **Nov. 22, 2019**  
(30) **Foreign Application Priority Data**  
Jul. 8, 2019 (JP) ..... JP2019-015320  
(51) **LOC (13) Cl.** ..... **21-01**  
(52) **U.S. Cl.**  
USPC ..... **D21/460; D21/455**  
(58) **Field of Classification Search**  
USPC ..... D21/455, 456, 459-464; 446/236-266  
CPC ..... A63H 1/00-1/32  
See application file for complete search history.

**OTHER PUBLICATIONS**

“JollyChic Spinning Top Toy”, posted Feb. 11, 2019 [Online], [Retrieved Oct. 16, 2020], from Internet: <https://www.jollychic.com/p/1pc-kids-spinning-top-set-fashion-cute-color-block-durable-toy-g0xdx0xv-q-fbxi-i48oooo-73.html#goToComments>.\*

*Primary Examiner* — Sandra Snapp  
*Assistant Examiner* — Mehri Bajoul  
(74) *Attorney, Agent, or Firm* — Oliff PLC

(56) **References Cited**  
**U.S. PATENT DOCUMENTS**  
D608,842 S \* 1/2010 Nishimoto ..... D21/460  
D610,209 S \* 2/2010 Nishimoto ..... D21/460  
D629,051 S \* 12/2010 Nishimoto ..... D21/460  
D629,468 S \* 12/2010 Ujita ..... D21/460  
D629,469 S \* 12/2010 Nishimoto ..... D21/460  
D629,847 S \* 12/2010 Ujita ..... D21/460  
D629,848 S \* 12/2010 Ujita ..... D21/460  
D639,348 S \* 6/2011 Ujita ..... D21/460  
D639,869 S \* 6/2011 Nishimoto ..... D21/460  
D646,729 S \* 10/2011 Ujita ..... D21/460  
D660,918 S \* 5/2012 Ujita ..... D21/460  
D665,859 S \* 8/2012 Horikoshi ..... D21/460  
D666,252 S \* 8/2012 Ujita ..... D21/460  
D666,253 S \* 8/2012 Ujita ..... D21/460

(57) **CLAIM**  
The ornamental design for an accessory for spinning top toy, as shown.

**DESCRIPTION**

FIG. 1 is a front elevational view of an accessory for spinning top toy;  
FIG. 2 is a rear elevational view thereof;  
FIG. 3 is a left-side elevational view thereof;  
FIG. 4 is a right-side elevational view thereof;  
FIG. 5 is a top plan view thereof;  
FIG. 6 is a bottom plan view thereof;  
FIG. 7 is a front, right-side, top perspective view thereof;  
FIG. 8 is a front, right-side, top exploded perspective view thereof; and,  
FIG. 9 is a rear, left-side, bottom exploded perspective view thereof.

**1 Claim, 9 Drawing Sheets**

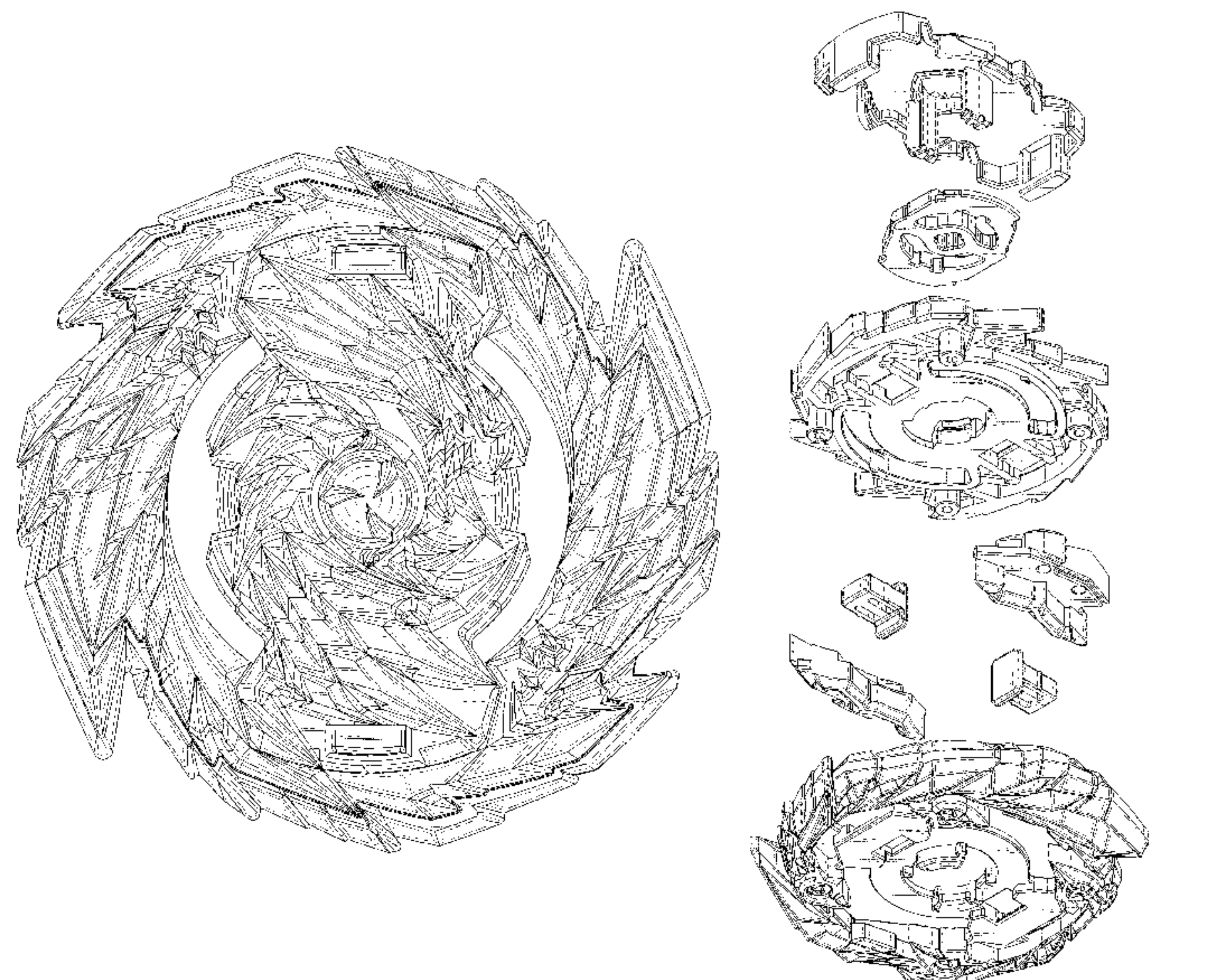



(56)

References Cited

U.S. PATENT DOCUMENTS

D834,101 S *	11/2018	Horikoshi	D21/460	D857,106 S *	8/2019	Narita	D21/460
D834,102 S *	11/2018	Muraki	D21/460	D857,107 S *	8/2019	Horikoshi	D21/460
D834,103 S *	11/2018	Horikoshi	D21/460	D857,108 S *	8/2019	Horikoshi	D21/460
D835,208 S *	12/2018	Horikoshi	D21/460	D857,109 S *	8/2019	Muraki	D21/460
D835,209 S *	12/2018	Hashiba	D21/460	D861,079 S *	9/2019	Matsukawa	D21/460
D835,724 S *	12/2018	Muraki	D21/460	D862,604 S *	10/2019	Matsukawa	D21/460
D837,304 S *	1/2019	Horikoshi	D21/460	D862,605 S *	10/2019	Horikoshi	D21/460
D837,305 S *	1/2019	Shindo	D21/460	D862,606 S *	10/2019	Horikoshi	D21/460
D837,899 S *	1/2019	Narita	D21/460	D862,607 S *	10/2019	Horikoshi	D21/460
D838,316 S *	1/2019	Shindo	D21/461	D862,608 S *	10/2019	Yamasaki	D21/460
D839,967 S *	2/2019	Horikoshi	D21/460	D862,609 S *	10/2019	Muraki	D21/460
D841,098 S *	2/2019	Narita	D21/460	D866,677 S *	11/2019	Horikoshi	D21/460
D841,099 S *	2/2019	Matsukawa	D21/460	D868,903 S *	12/2019	Paolino, Jr.	D21/461
D842,934 S *	3/2019	Muraki	D21/460	D873,351 S *	1/2020	Horikoshi	D21/460
D842,935 S *	3/2019	Horikoshi	D21/460	D875,841 S *	2/2020	Nakajima	D21/460
D843,489 S *	3/2019	Horikoshi	D21/460	D875,842 S *	2/2020	Nakajima	D21/460
D844,069 S *	3/2019	Horikawa	D21/460	D875,843 S *	2/2020	Muraki	D21/460
D845,396 S *	4/2019	Horikoshi	D21/460	D875,844 S *	2/2020	Horikoshi	D21/460
D846,034 S *	4/2019	Horikawa	D21/460	D875,845 S *	2/2020	Muraki	D21/460
D846,655 S *	4/2019	Horikawa	D21/460	D876,554 S *	2/2020	Muraki	D21/460
D846,656 S *	4/2019	Horikoshi	D21/460	D878,482 S *	3/2020	Hama	D21/461
D848,539 S *	5/2019	Horikoshi	D21/460	D880,623 S *	4/2020	Narita	D21/460
D849,846 S *	5/2019	Narita	D21/460	D880,624 S *	4/2020	Hashiba	D21/460
D849,847 S *	5/2019	Horikoshi	D21/460	D884,801 S *	5/2020	Muraki	D21/460
D849,848 S *	5/2019	Saito	D21/460	D886,903 S *	6/2020	Ishii	D21/338
D849,849 S *	5/2019	Muraki	D21/460	D886,910 S *	6/2020	Horikoshi	D21/460
D851,178 S *	6/2019	Narita	D21/460	D886,911 S *	6/2020	Horikoshi	D21/460
D851,708 S *	6/2019	Saito	D21/460	D886,912 S *	6/2020	Muraki	D21/460
D851,709 S *	6/2019	Muraki	D21/460	D886,913 S *	6/2020	Hama	D21/460
D852,280 S *	6/2019	Horikoshi	D21/460	D886,914 S *	6/2020	Hama	D21/460
D852,281 S *	6/2019	Horikoshi	D21/460	D889,564 S *	7/2020	Horikoshi	D21/460
D852,894 S *	7/2019	Hama	D21/460	D891,526 S *	7/2020	Hama	D21/460
D854,095 S *	7/2019	Narita	D21/460	D891,527 S *	7/2020	Hama	D21/460
D854,096 S *	7/2019	Muraki	D21/460	D891,528 S *	7/2020	Hama	D21/460
D854,097 S *	7/2019	Muraki	D21/460	D891,529 S *	7/2020	Hama	D21/460
D854,626 S *	7/2019	Horikoshi	D21/460	D892,226 S *	8/2020	Hama	D21/460
D854,627 S *	7/2019	Saito	D21/460	D892,227 S *	8/2020	Hama	D21/460
D854,628 S *	7/2019	Saito	D21/460	D892,939 S *	8/2020	Matsukawa	D21/460
D855,117 S *	7/2019	Horikoshi	D21/460	D892,940 S *	8/2020	Matsukawa	D21/460
D855,118 S *	7/2019	Saito	D21/460	D892,941 S *	8/2020	Matsukawa	D21/460
D855,119 S *	7/2019	Saito	D21/460	D892,942 S *	8/2020	Muraki	D21/460
D855,706 S *	8/2019	Narita	D21/460	D892,943 S *	8/2020	Horikoshi	D21/460
				D892,944 S *	8/2020	Matsukawa	D21/460

\* cited by examiner

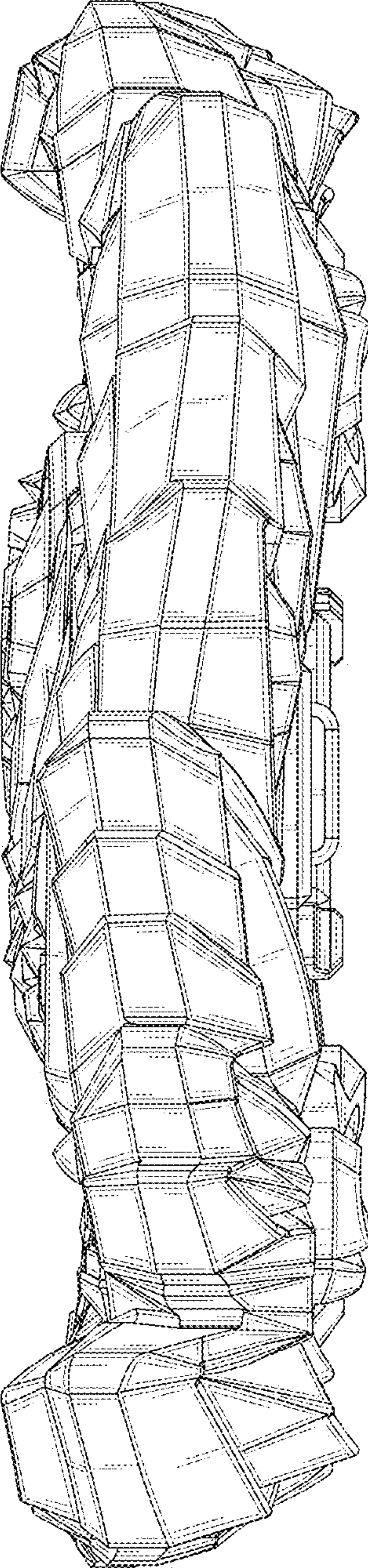

FIG. 1



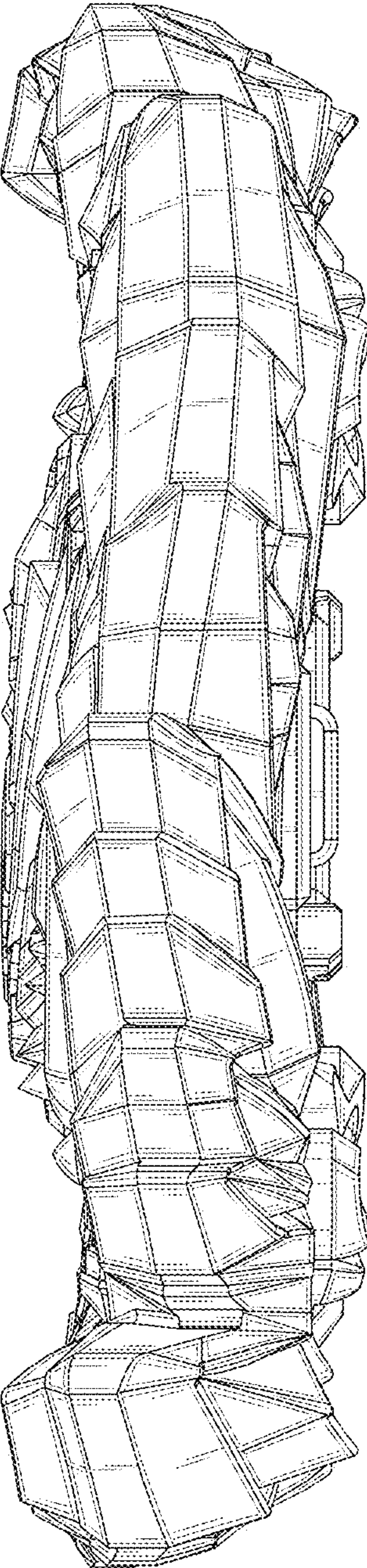

FIG. 2

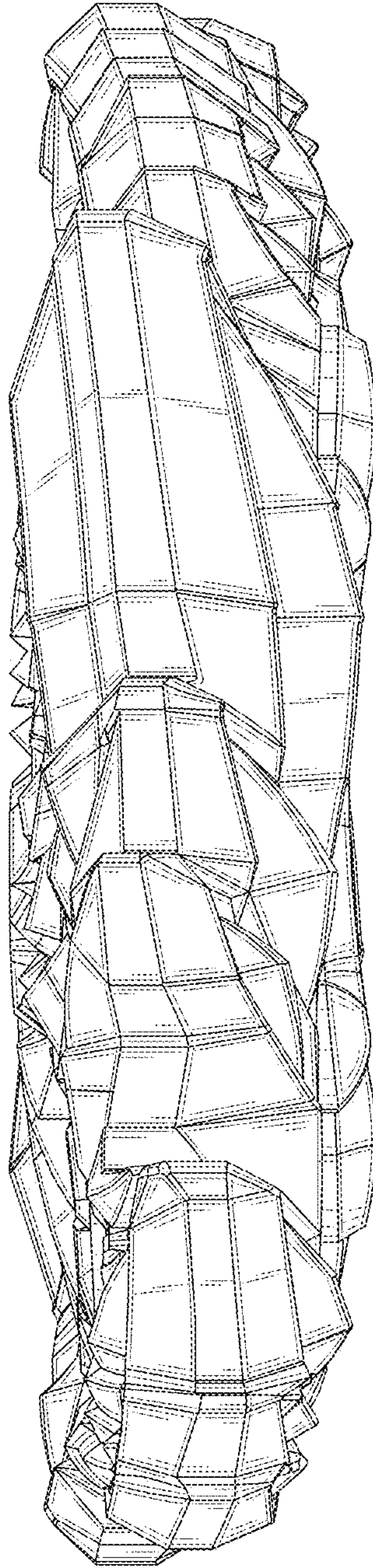

FIG. 3

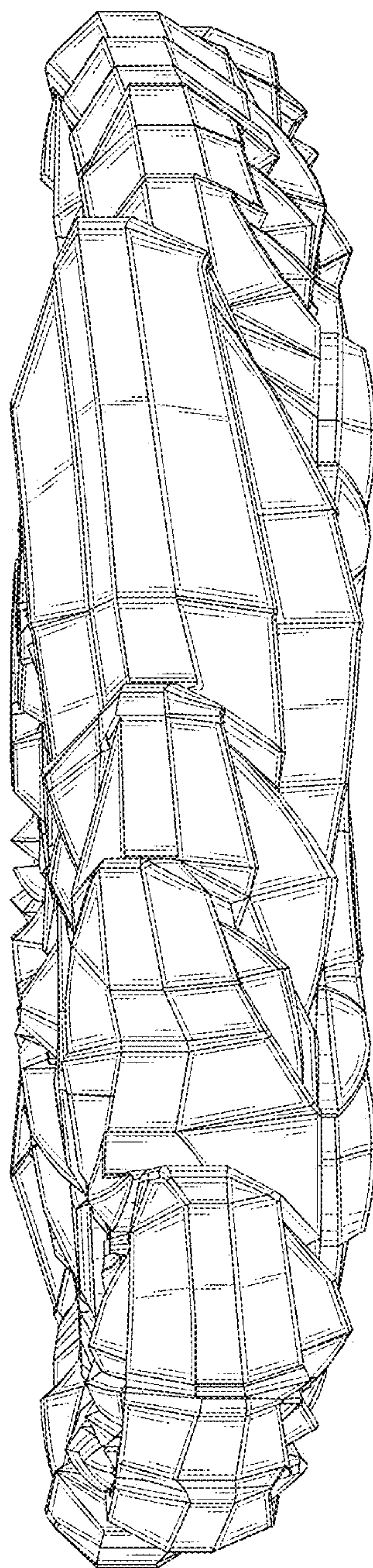

FIG. 4



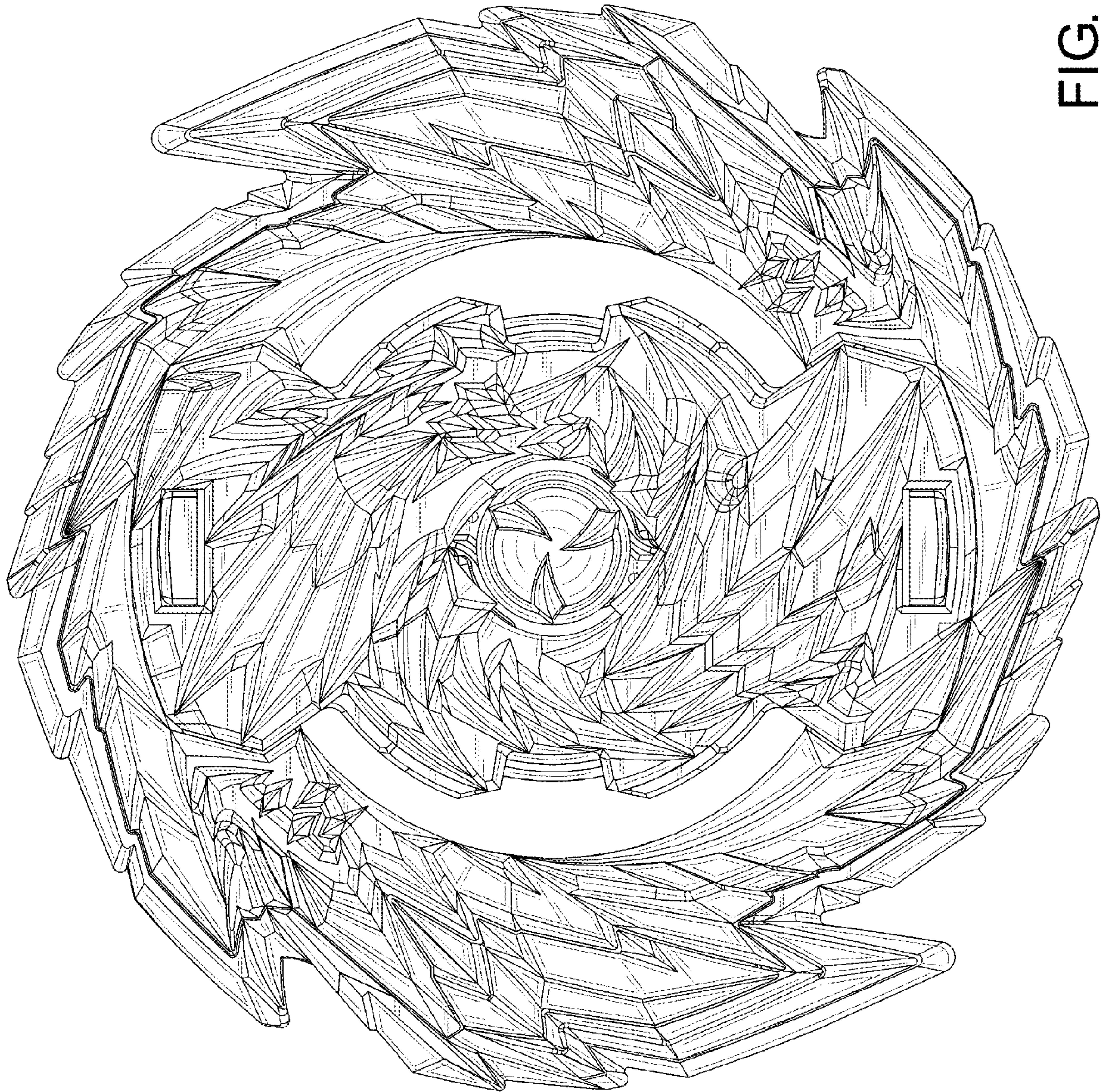

FIG. 5



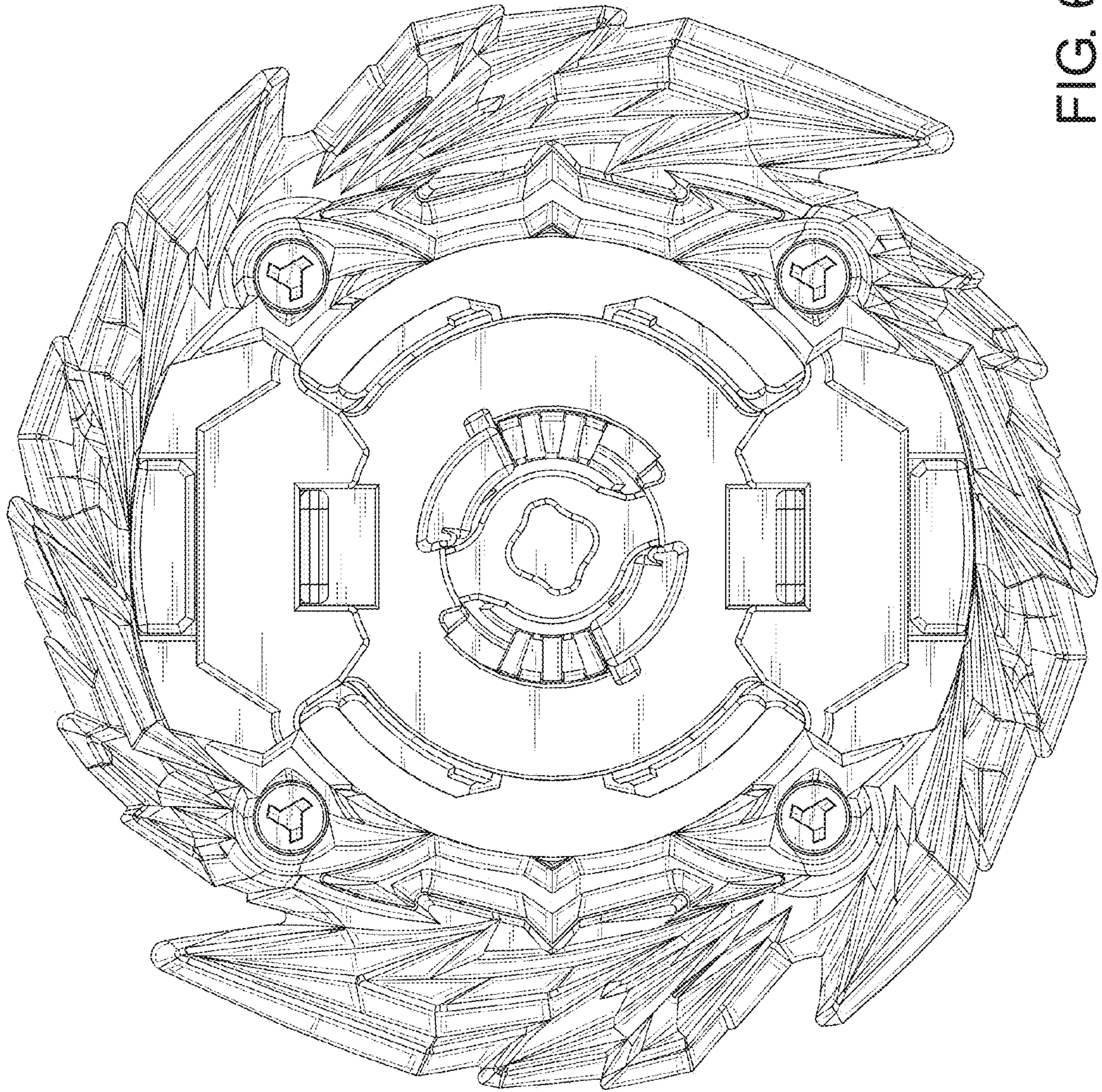

FIG. 6



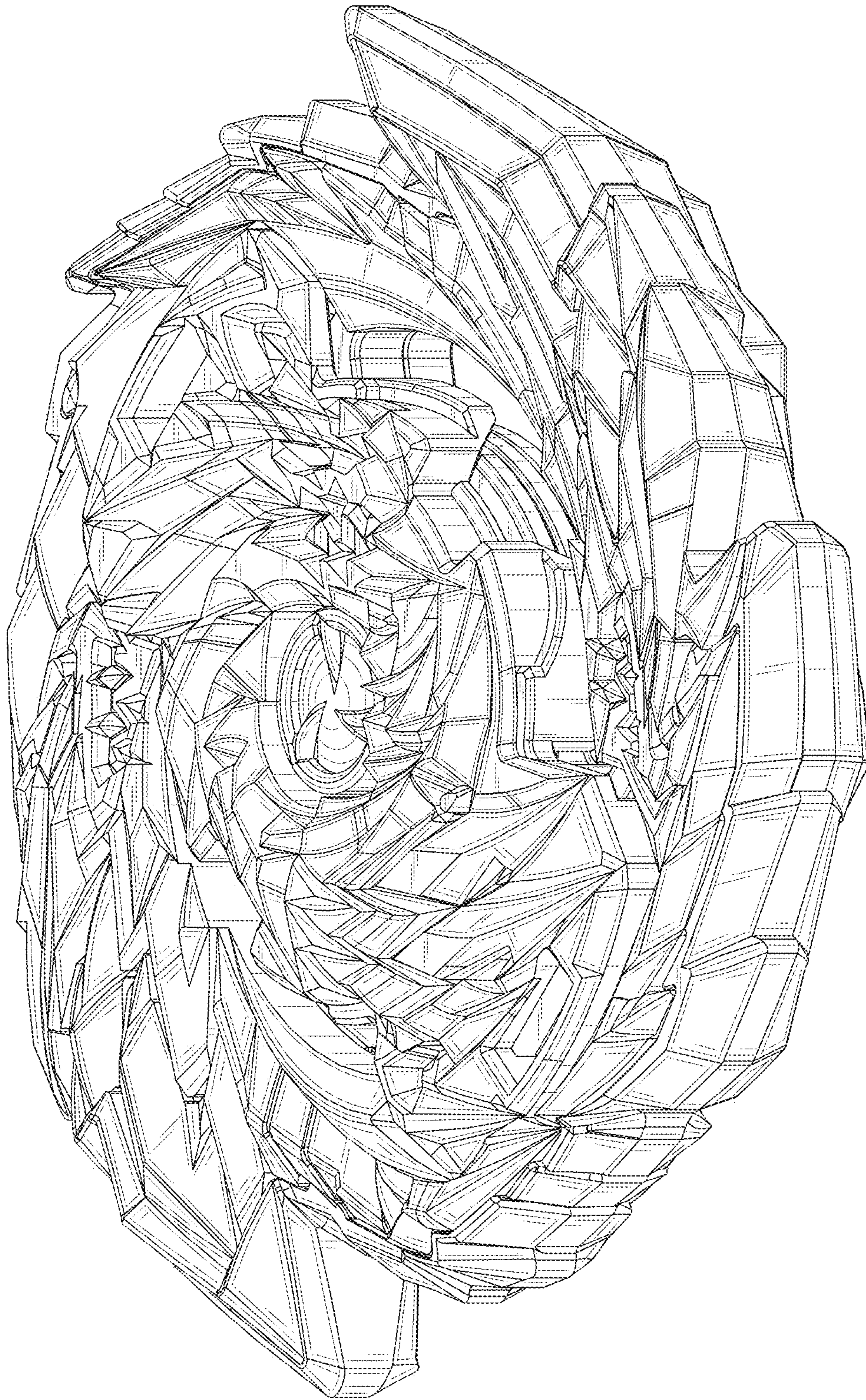

FIG. 7



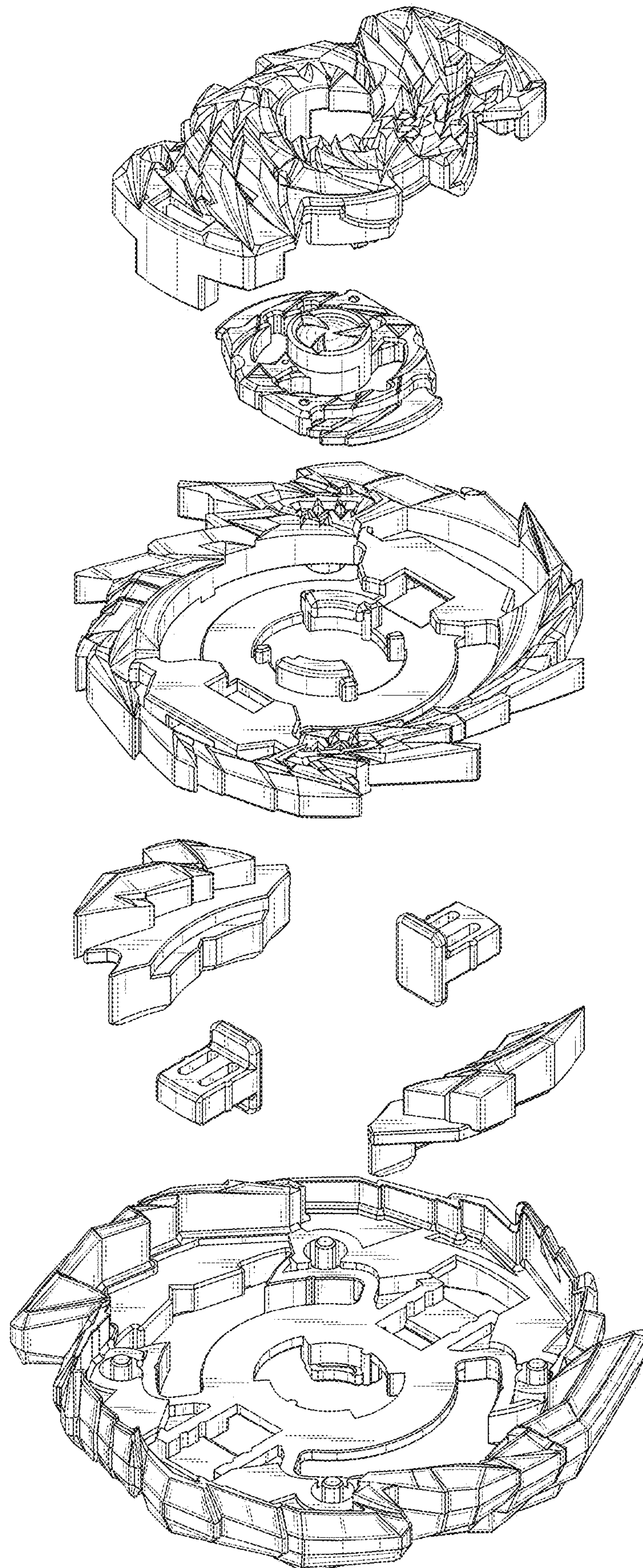

FIG. 8



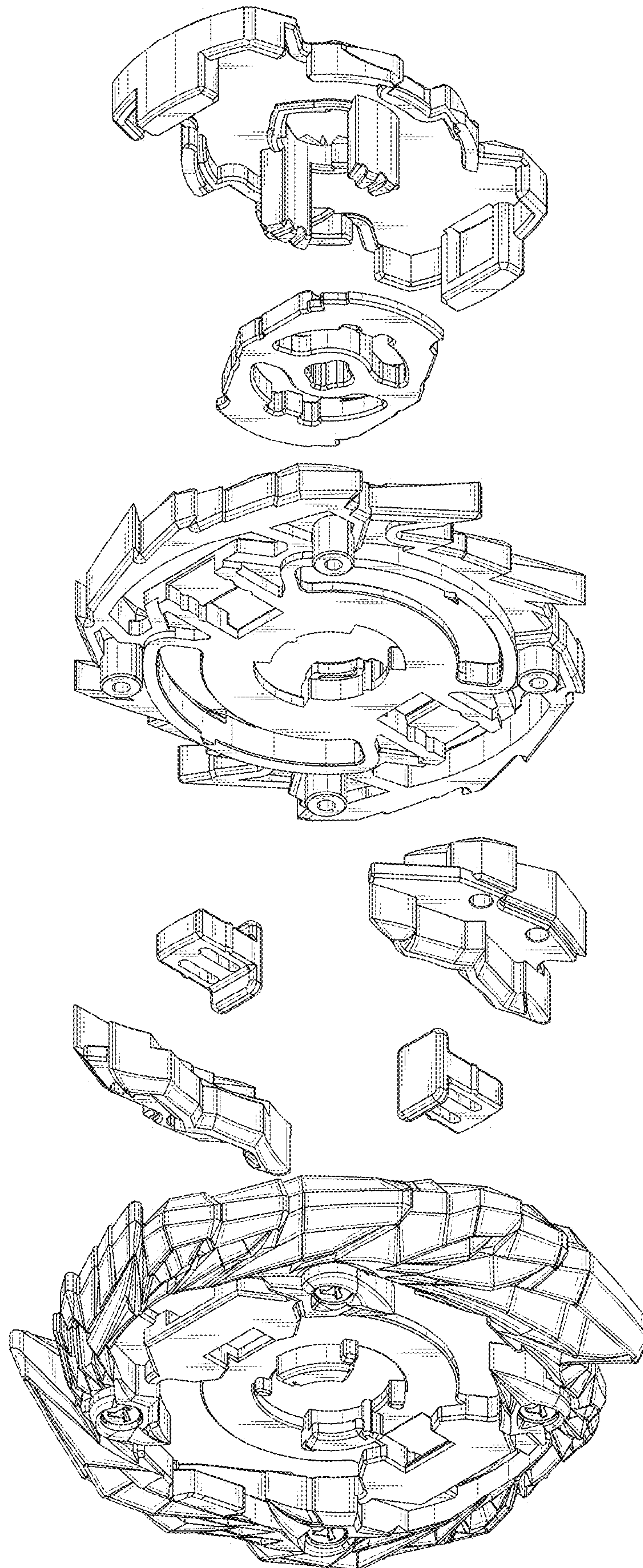

FIG. 9