



US00D912036S

(12) **United States Design Patent**
Zhang

(10) **Patent No.:** **US D912,036 S**

(45) **Date of Patent:** **** Mar. 2, 2021**

(54) **CELL PHONE STAND AND WALL SHELF COMBINATION**

(71) Applicant: **Yongfeng Zhang**, Guangdong (CN)

(72) Inventor: **Yongfeng Zhang**, Guangdong (CN)

(**) Term: **15 Years**

(21) Appl. No.: **29/741,502**

(22) Filed: **Jul. 13, 2020**

(51) **LOC (13) Cl.** **14-03**

(52) **U.S. Cl.**
USPC **D14/253**

(58) **Field of Classification Search**
USPC D14/250–253, 447, 451, 452, 440, 434, D14/458, 432; D13/107, 108; D12/415; D3/218; D8/349, 373, 380, 381, 353, D8/354; D6/675, 672, 673, 675.4, 553, D6/676, 310, 406.3, 406.4, 406.5, 406.6, D6/407, 567, 300, 682.3, 574
CPC B60R 2011/0008; B60R 11/02; B60R 11/0241; B60R 11/0258; B60R 11/0252; B60R 2011/0294; F16M 11/00; F16M 11/04; F16M 11/041; F16M 11/02; F16M 11/06; F16M 13/00; H04M 1/02; H04M 1/04; H04M 1/11; H04M 1/12; A47F 7/022; B62J 11/00; H05K 7/00; G03B 17/56

See application file for complete search history.

(56) **References Cited**

U.S. PATENT DOCUMENTS

D545,604 S * 7/2007 Eyman D6/574
D572,901 S 7/2008 St. George
D667,394 S * 9/2012 Bau D14/250
D668,245 S * 10/2012 Bau D14/250
D685,366 S * 7/2013 Ding D14/253

D686,200 S * 7/2013 Huang D14/253
D725,093 S * 3/2015 Sun D14/250
D729,223 S * 5/2015 Haarbuerger D14/253
9,249,922 B2 * 2/2016 Haarbuerger A47B 23/04
D772,812 S * 11/2016 Choe D13/108
D782,845 S * 4/2017 Golembieski D6/574
D782,846 S * 4/2017 Golembieski D6/574
D791,113 S * 7/2017 Tien D14/250
D799,203 S 10/2017 Karl, IV et al.
D826,917 S * 8/2018 Zhong D14/253
D839,867 S * 2/2019 Zhao D14/253
D840,996 S * 2/2019 Lambert D14/253
D853,377 S * 7/2019 Crandon D14/253
D859,031 S * 9/2019 Ritch A61B 17/22
D863,291 S * 10/2019 Shi D14/253
D870,097 S * 12/2019 Echeverry D14/253
10,563,812 B2 * 2/2020 Chen G06F 1/1607

* cited by examiner

Primary Examiner — Janice Hallmark
(74) *Attorney, Agent, or Firm* — ScienBiziP, P.C.

(57) **CLAIM**

The ornamental design for a cell phone stand and wall shelf combination, as shown and described.

DESCRIPTION

FIG. 1 is a front perspective view of a cell phone stand and wall shelf combination, showing my design.
FIG. 2 is a front elevation view thereof.
FIG. 3 is a rear elevation view thereof.
FIG. 4 is a left side elevation view thereof.
FIG. 5 is a right side elevation view thereof.
FIG. 6 is a top plan view thereof; and,
FIG. 7 is a bottom plan view thereof.
The broken lines in the drawings depict portions of the cell phone stand and wall shelf combination that form no part of the claimed design.

1 Claim, 7 Drawing Sheets

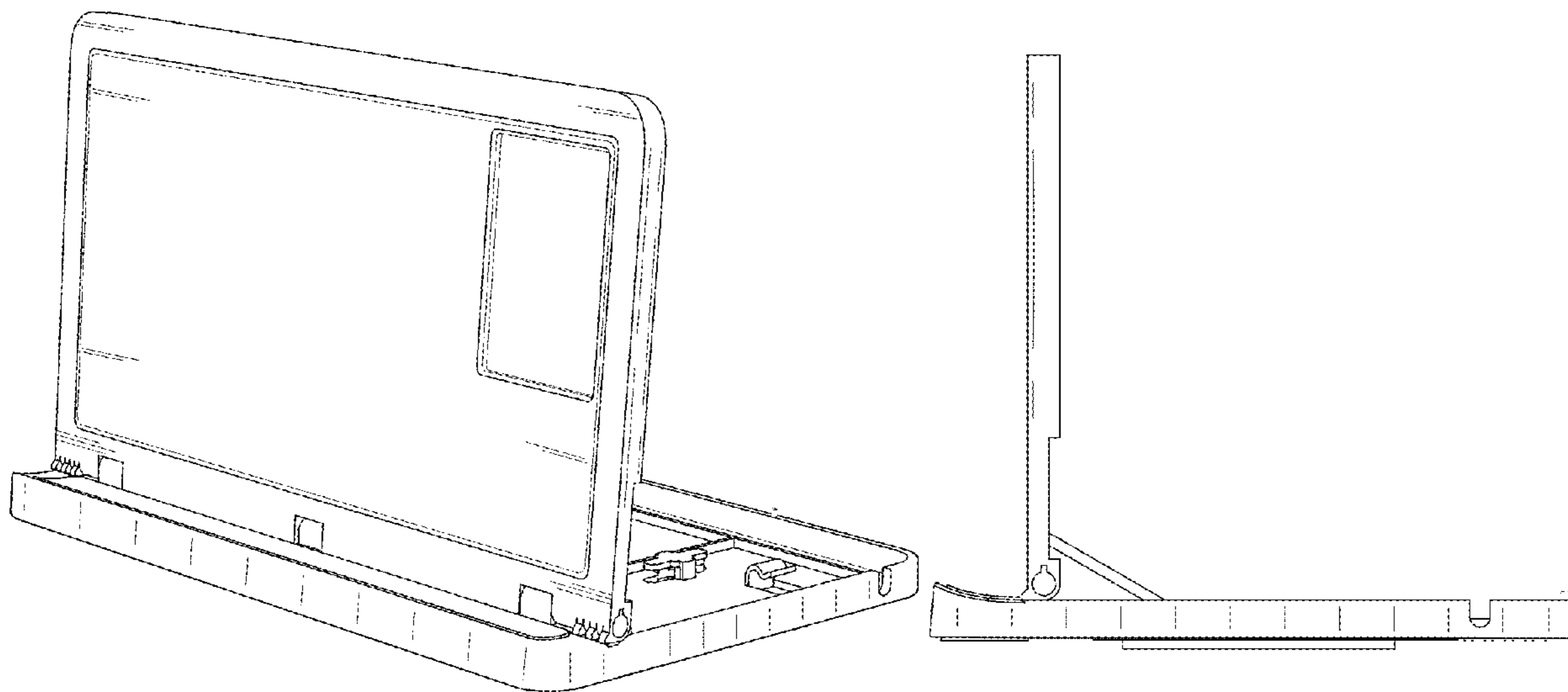

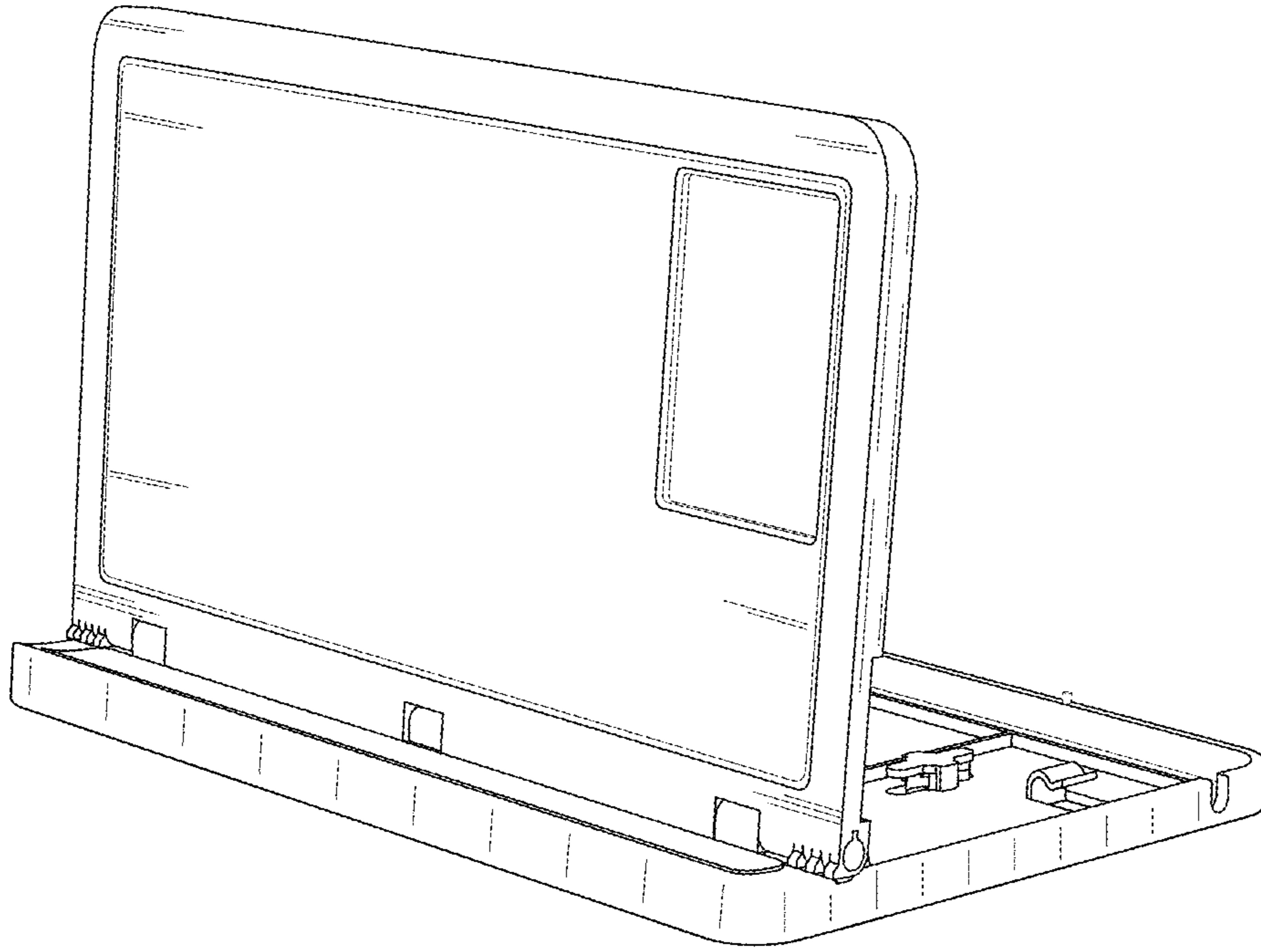

FIG.1

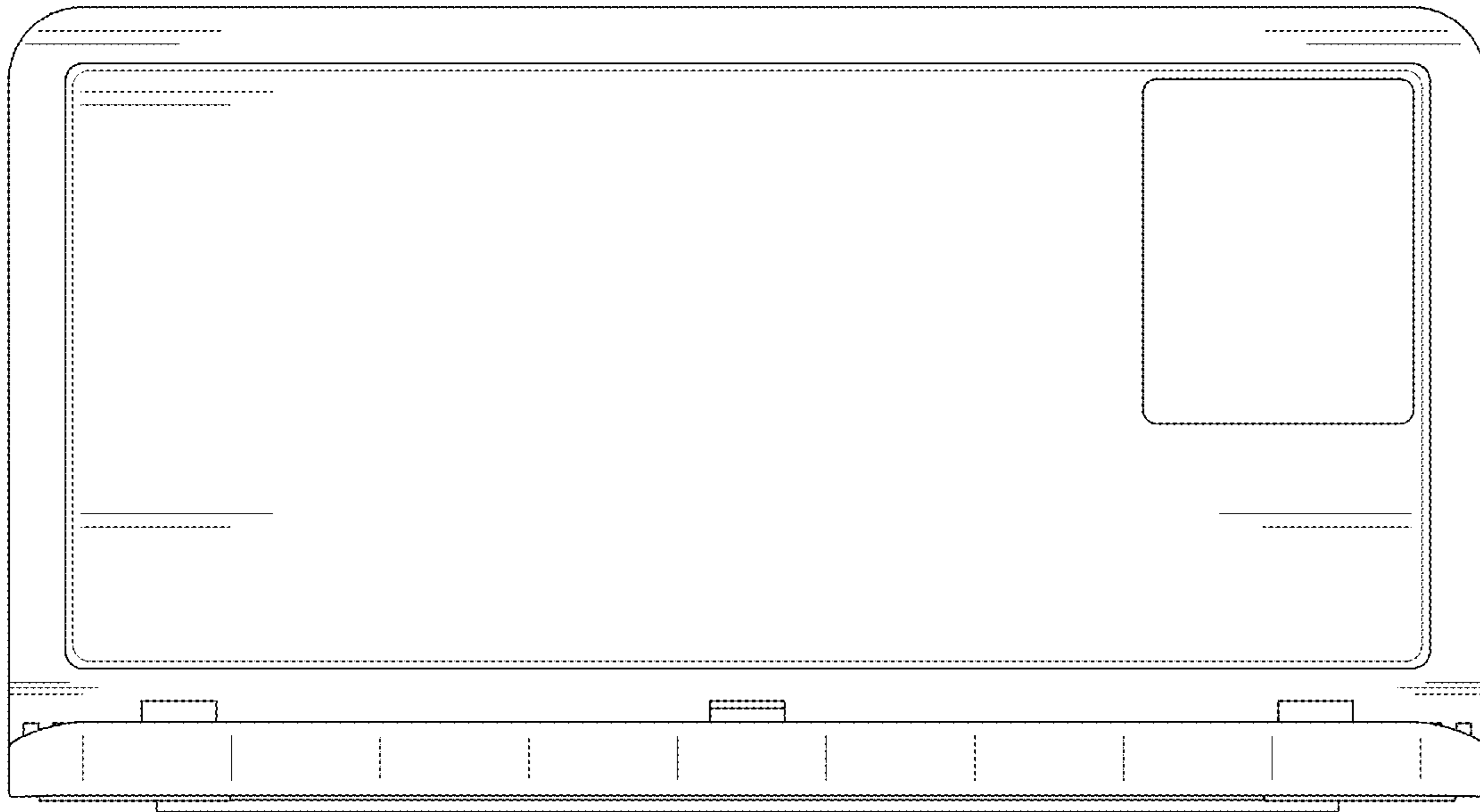

FIG.2

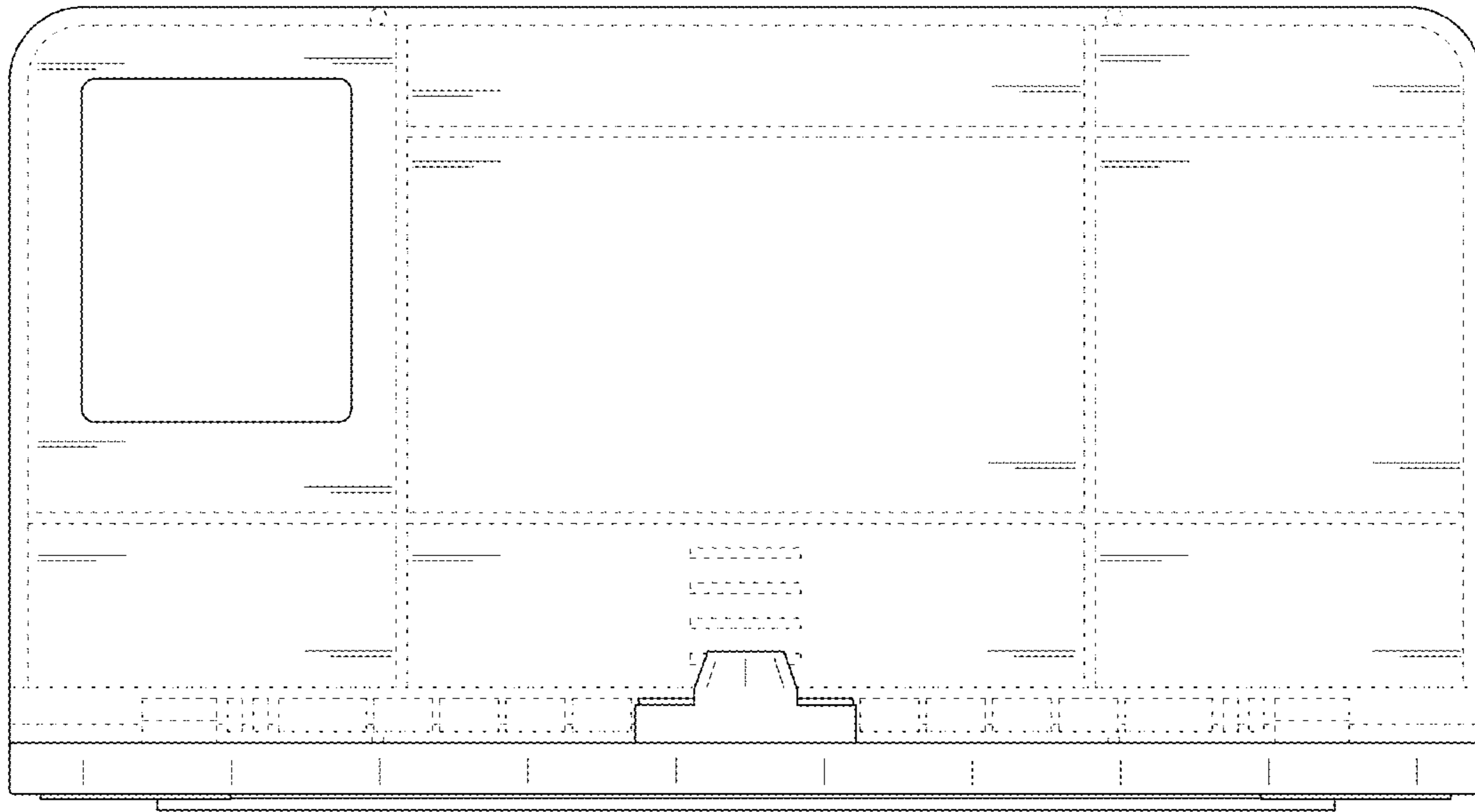

FIG.3

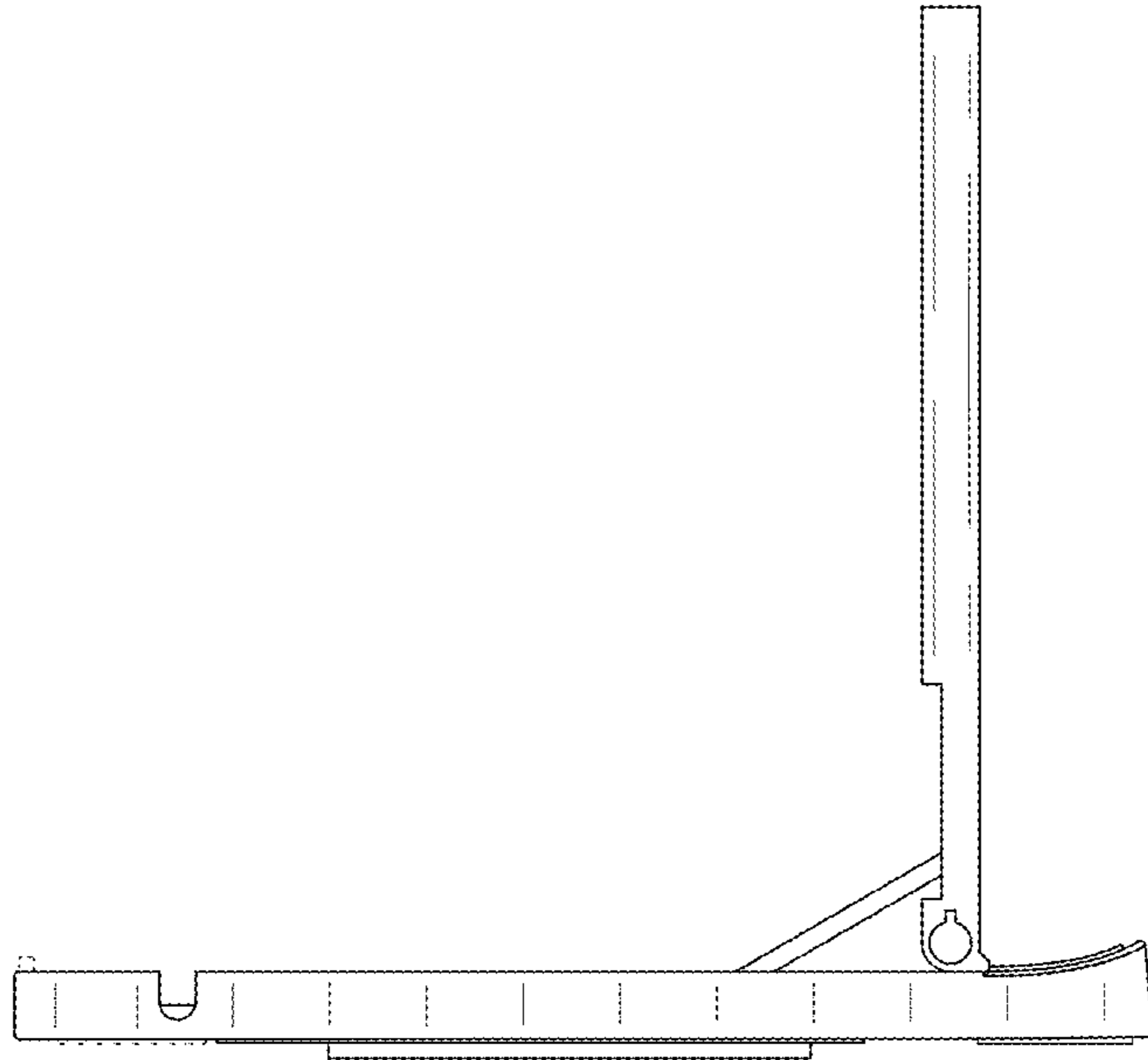

FIG.4

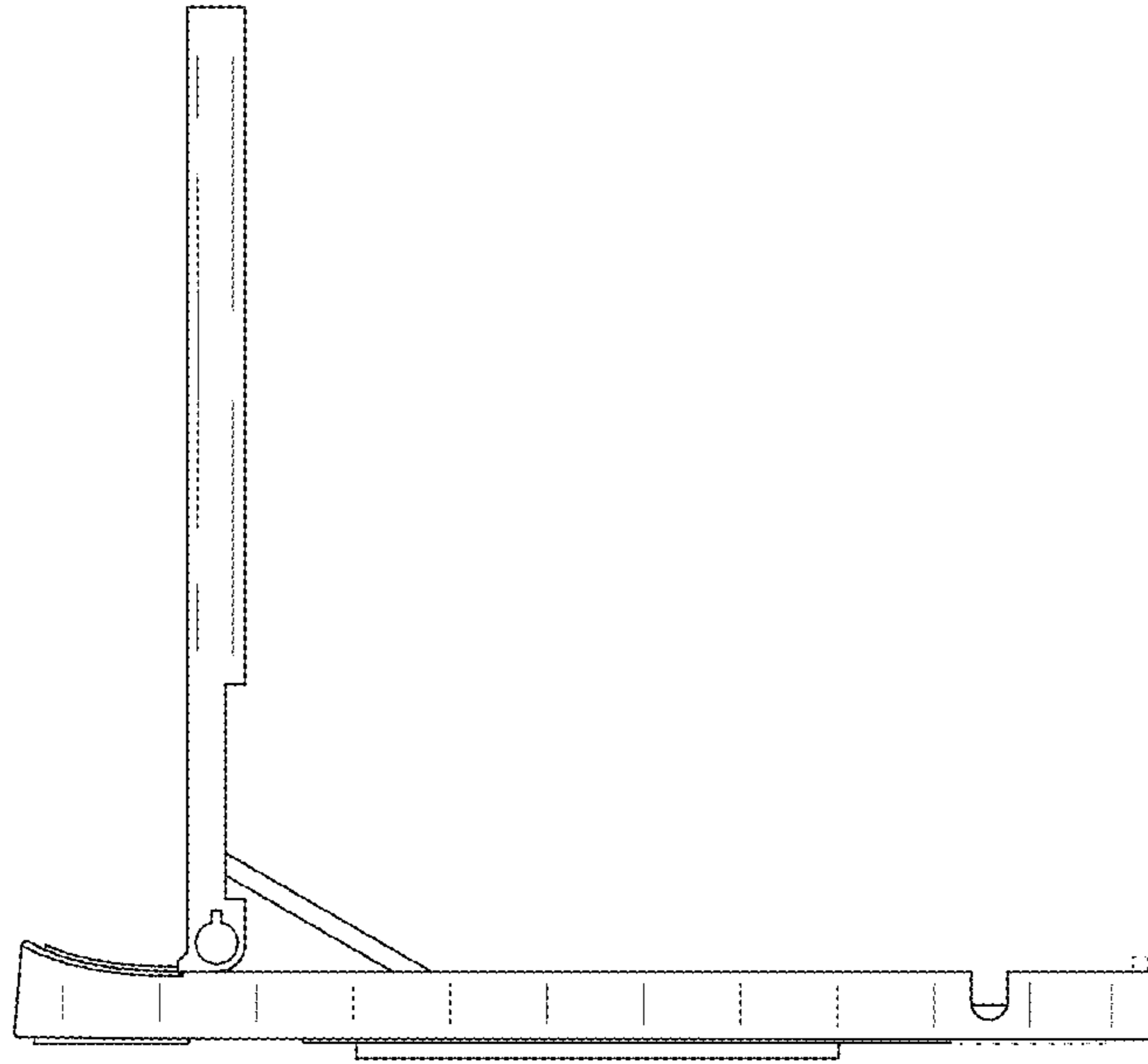

FIG.5

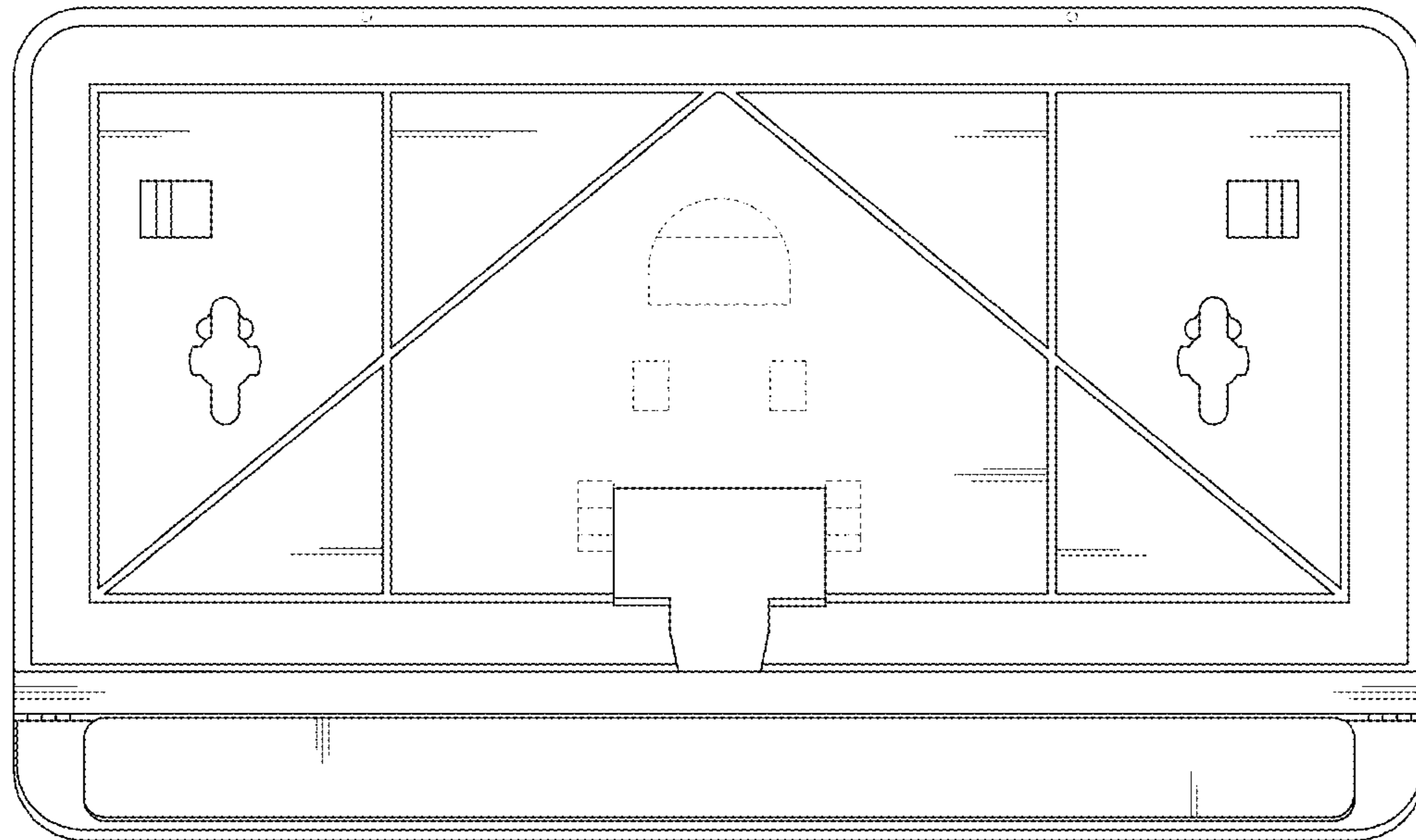

FIG.6

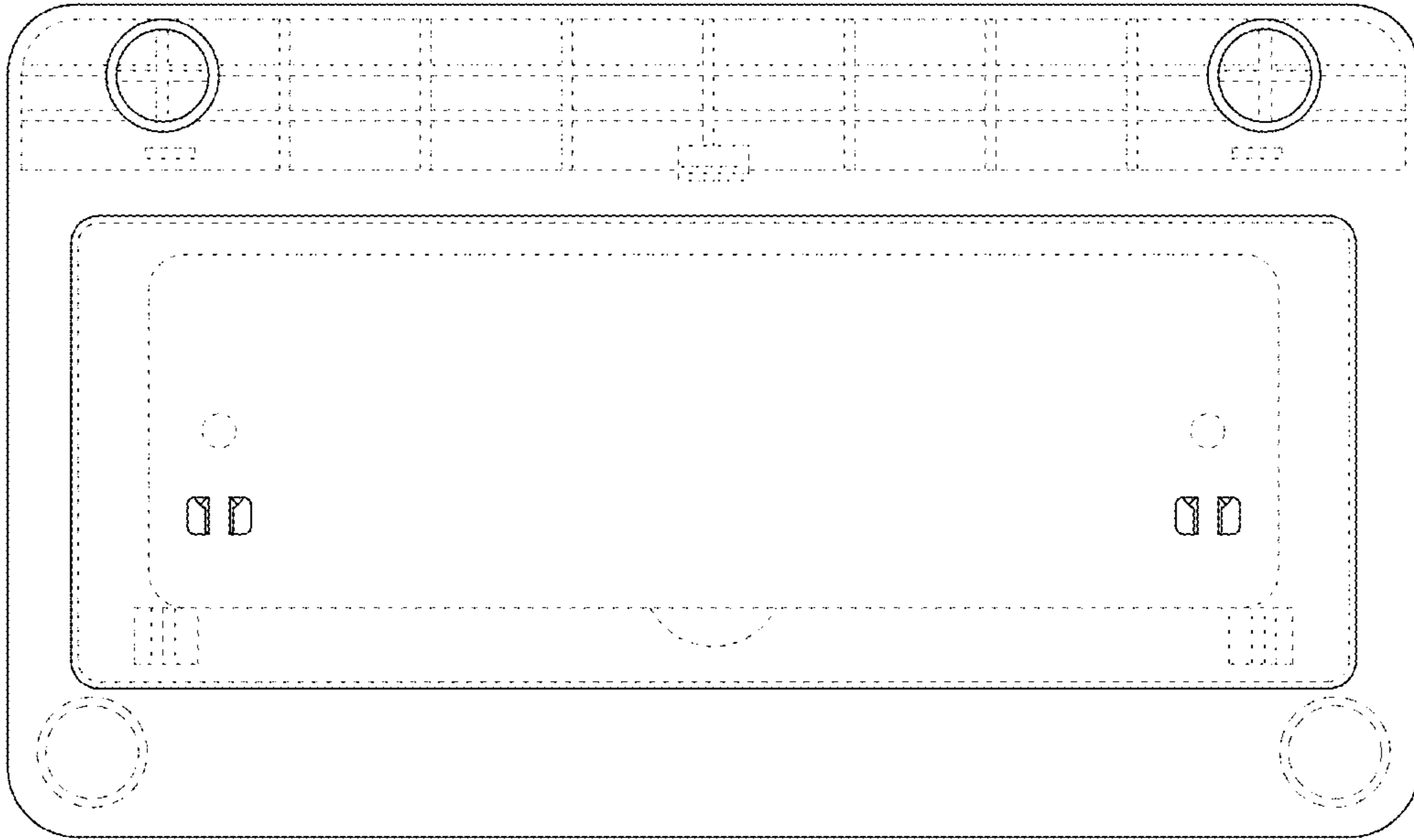

FIG.7