



US00D911915S

(12) **United States Design Patent**
Choi et al.

(10) **Patent No.:** **US D911,915 S**
(45) **Date of Patent:** **** Mar. 2, 2021**

(54) **CARGO CONTAINER**

B65D 90/00; B65D 90/06; B65D 90/02;
B65D 90/022; B65D 90/14; B65D 25/00;
B65D 25/02

(71) Applicant: **Amoskeag ADV LLC**, Manchester, NH
(US)

See application file for complete search history.

(72) Inventors: **Sooshin Choi**, Bedford, NH (US);
Spencer Trafton, Nashua, NH (US)

(56) **References Cited**

(73) Assignee: **Amoskeag ADV LLC**, Manchester, NH
(US)

U.S. PATENT DOCUMENTS

(**) Term: **15 Years**

6,161,714 A * 12/2000 Matsuura B62D 29/045
220/1.5
D734,029 S * 7/2015 Lee, II D3/272
D740,555 S * 10/2015 Huber D3/272
D740,556 S * 10/2015 Huber D3/272
9,248,958 B2 * 2/2016 Pherson B32B 27/281
10,773,881 B2 * 9/2020 Pherson B64D 9/00

(21) Appl. No.: **29/697,525**

* cited by examiner

(22) Filed: **Jul. 9, 2019**

Primary Examiner — Abraham Bahta

(51) **LOC (13) Cl.** **12-16**

(74) *Attorney, Agent, or Firm* — Toohey Law Group,
LLC

(52) **U.S. Cl.**

USPC **D12/415**; D3/272

(58) **Field of Classification Search**

(57) **CLAIM**

The ornamental design for a cargo container, as shown and described.

USPC 119/496–499, 491, 482, 453, 474;
206/434, 427, 467, 386, 523–528;
220/495.03, 1.5, 3.3, 545, 607, 626, 548;
229/122, 200, 87.01, 87.19, 116.1, 103.2;
D30/108–109, 118; D3/201, 273, 232,
D3/287, 276, 272, 215, 282, 217, 225,
D3/218, 226, 905; 383/6, 17–22, 66,
383/121.1, 108, 33; 222/92–95;
312/297; 217/7, 5

DESCRIPTION

CPC .. B65D 77/0406; B65D 77/003; B65D 88/14;
B65D 88/129; B65D 88/12; B65D
88/121; B65D 88/00; B65D 88/02; B65D
88/127; B65D 88/52; B65D 88/5261;

FIG. 1 is a back, top, and right-side perspective view of the cargo container, showing our new design;
FIG. 2 is a top plan view thereof;
FIG. 3 is a bottom plan thereof;
FIG. 4 is a right-side elevational view thereof;
FIG. 5 is a left-side elevational view thereof;
FIG. 6 is a front elevational view thereof; and,
FIG. 7 is a back elevational view thereof.

1 Claim, 7 Drawing Sheets

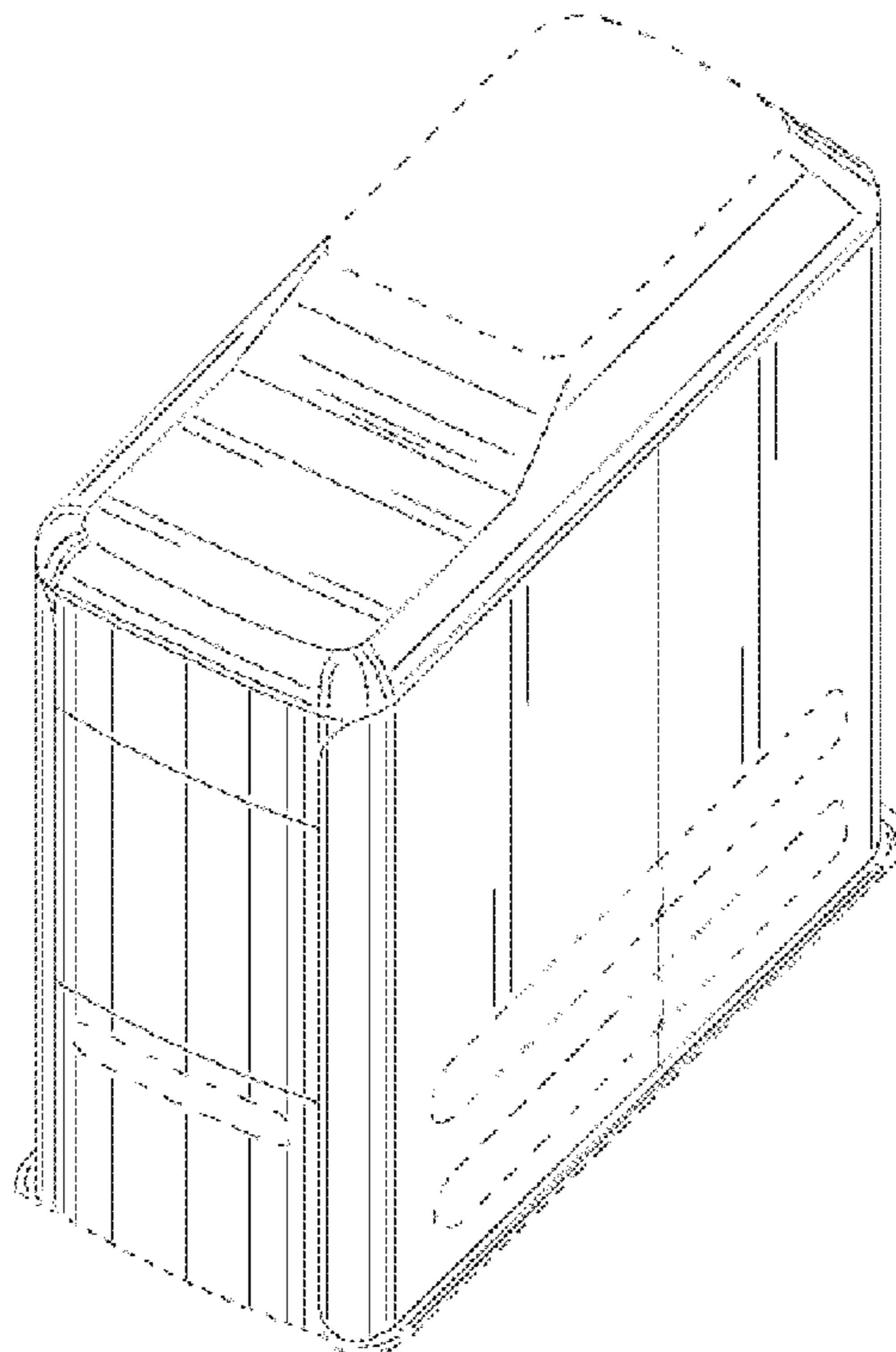

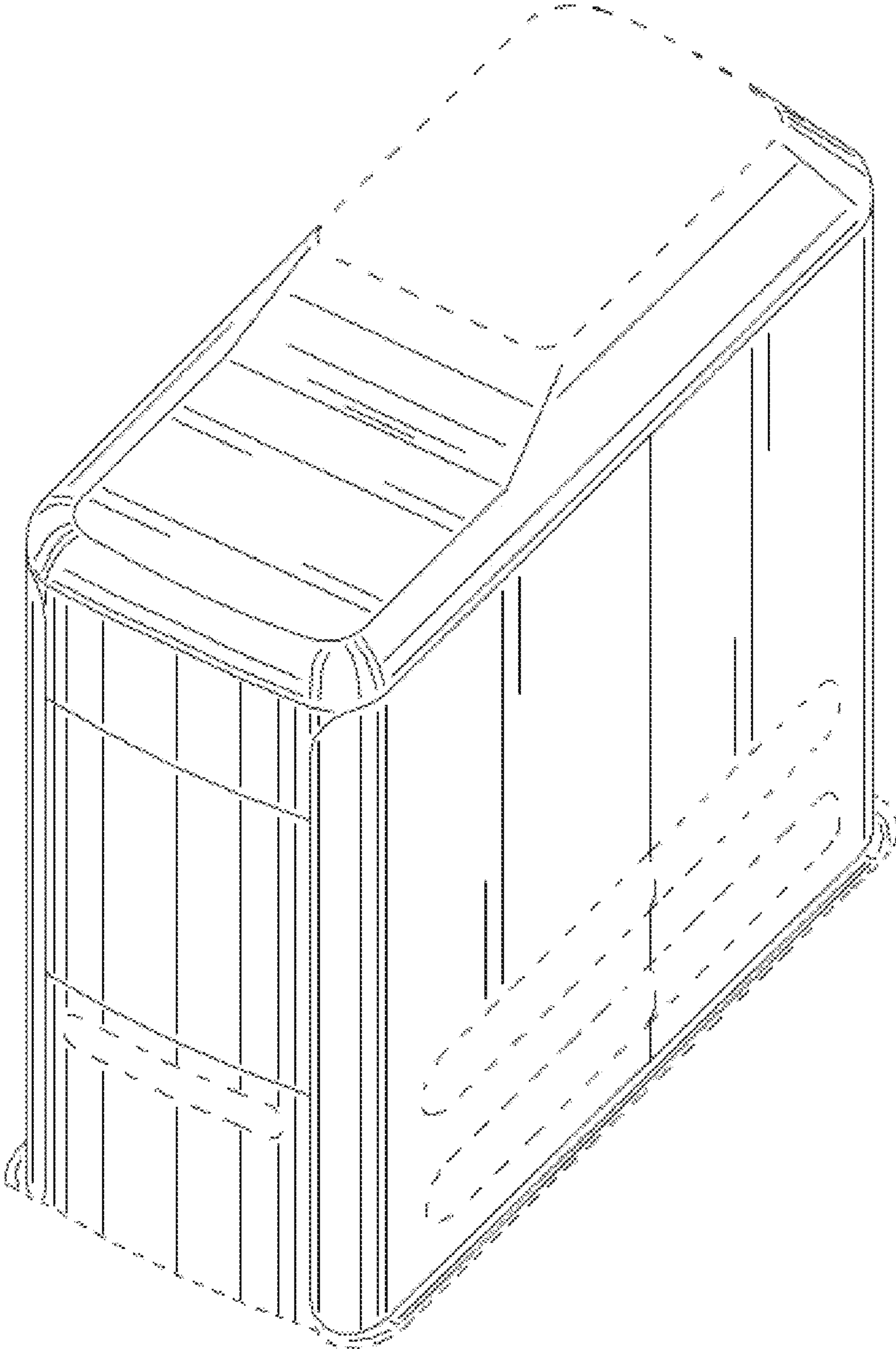

FIG. 1

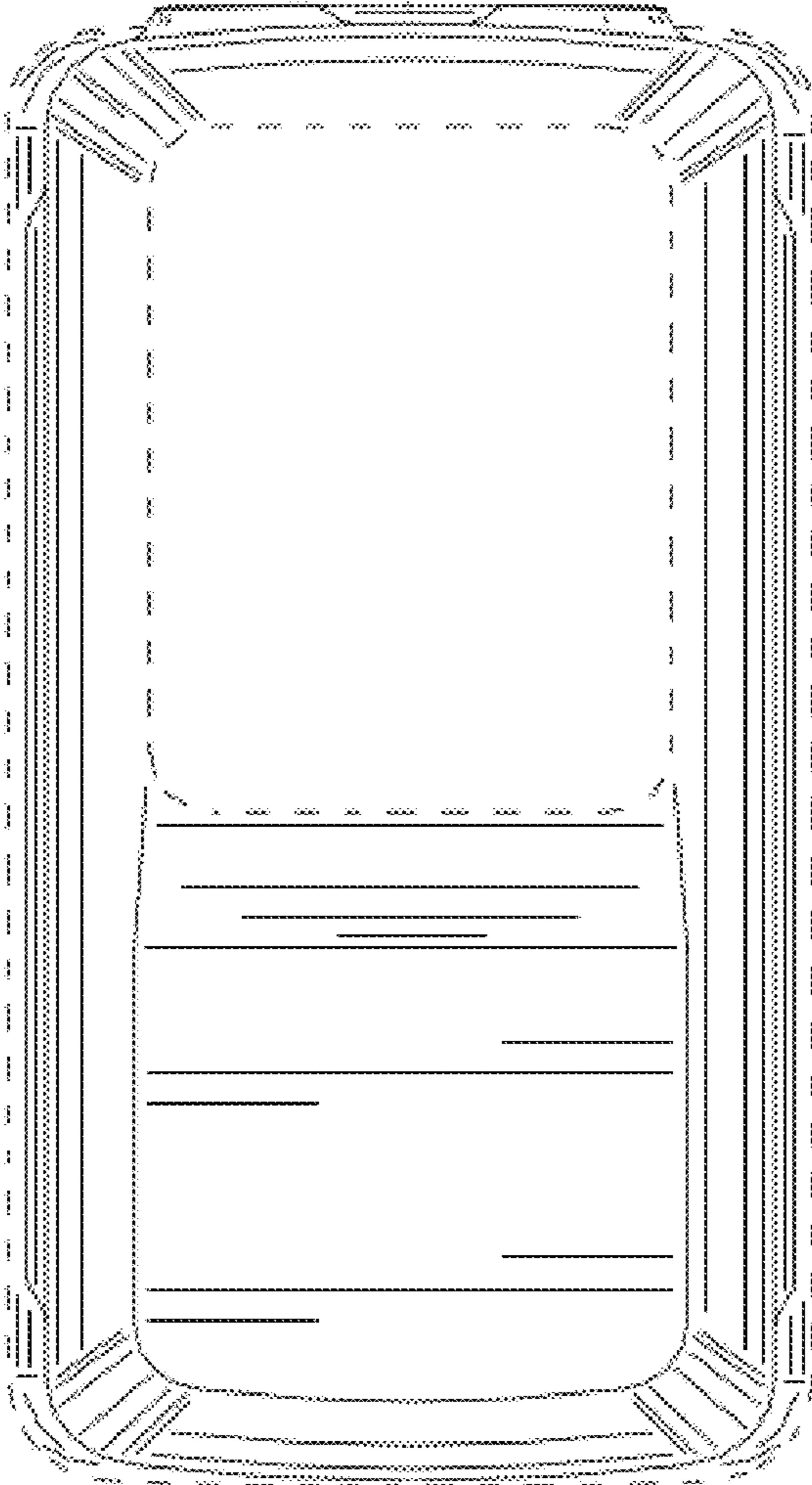

FIG. 2

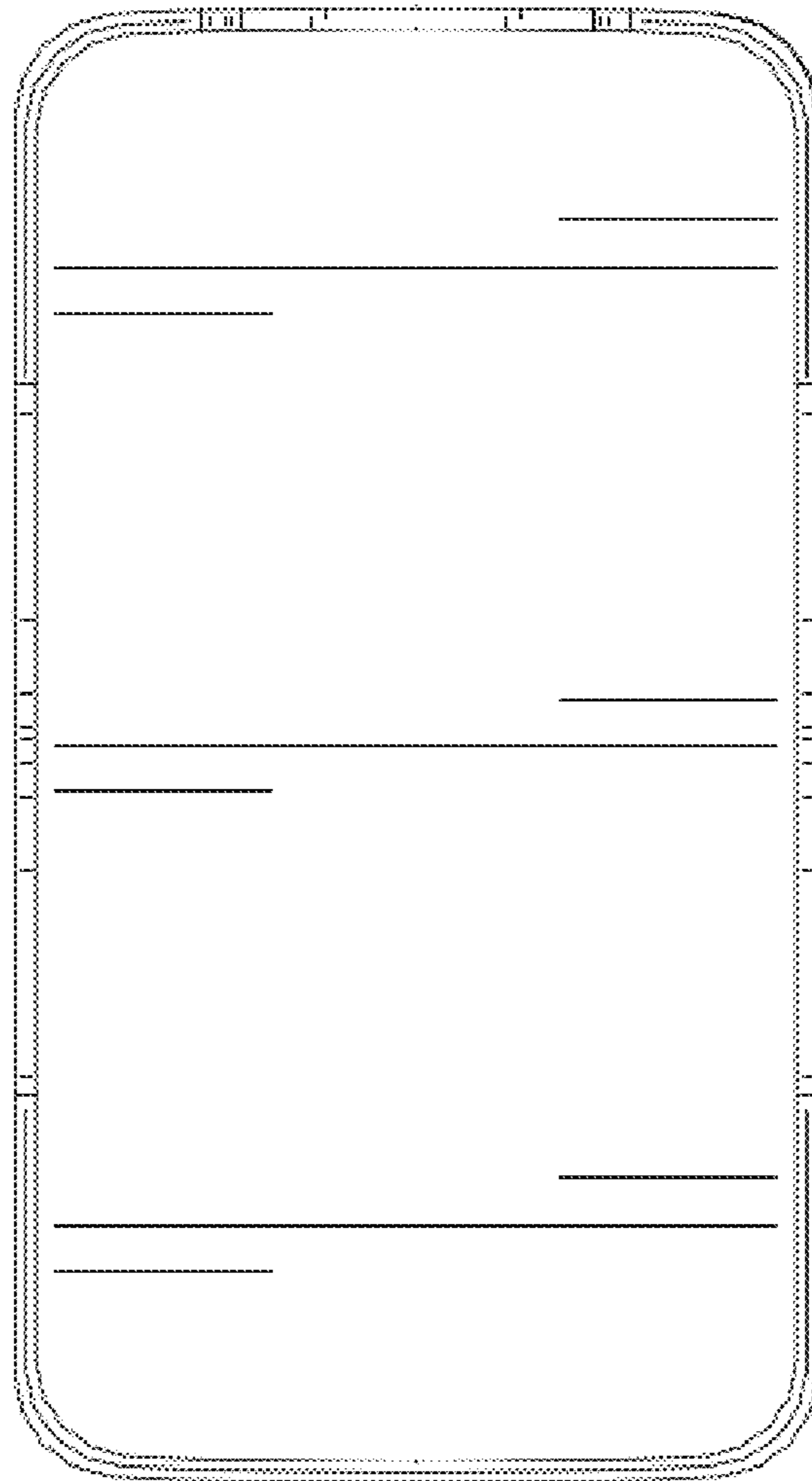

FIG. 3

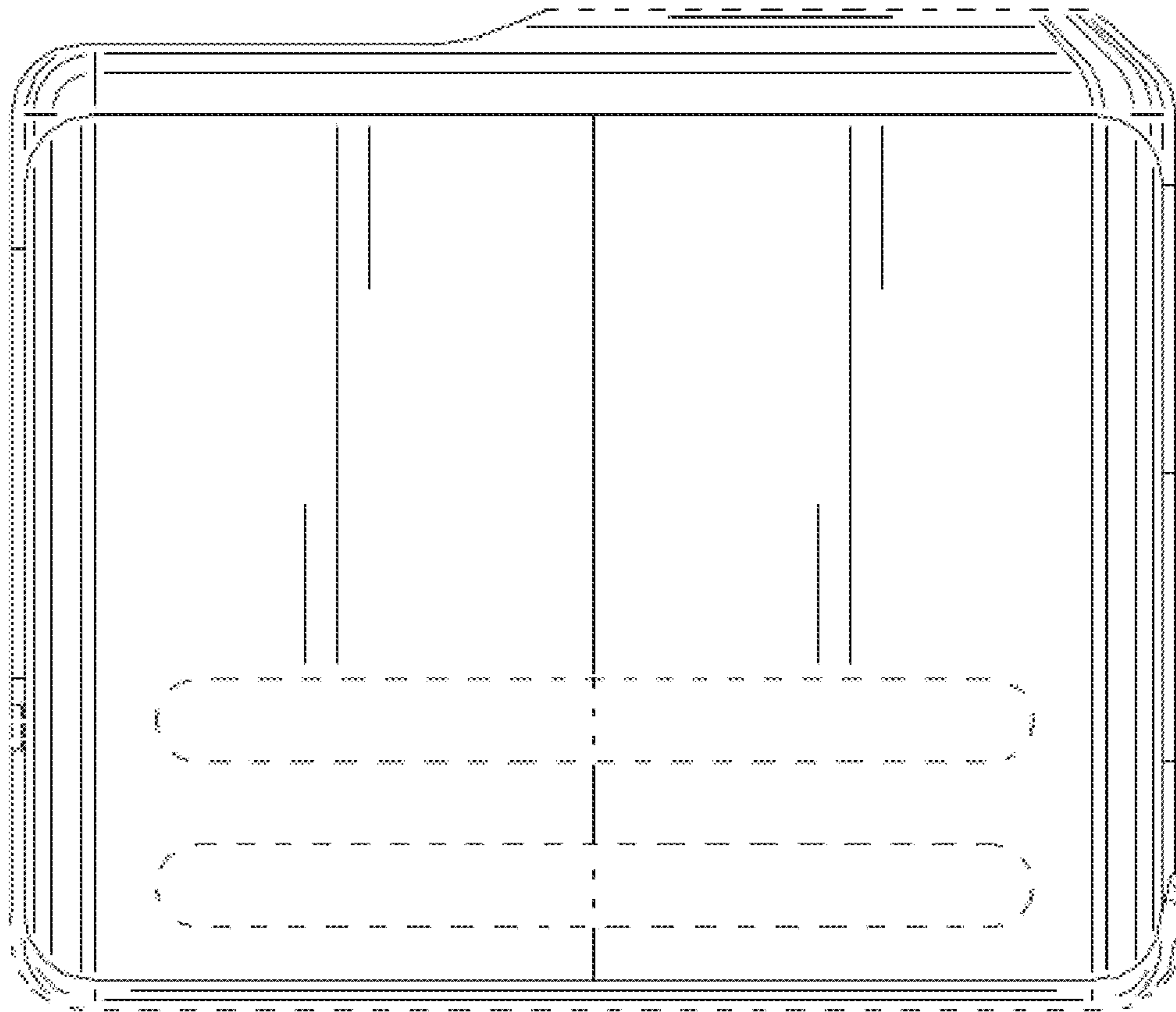

FIG. 4

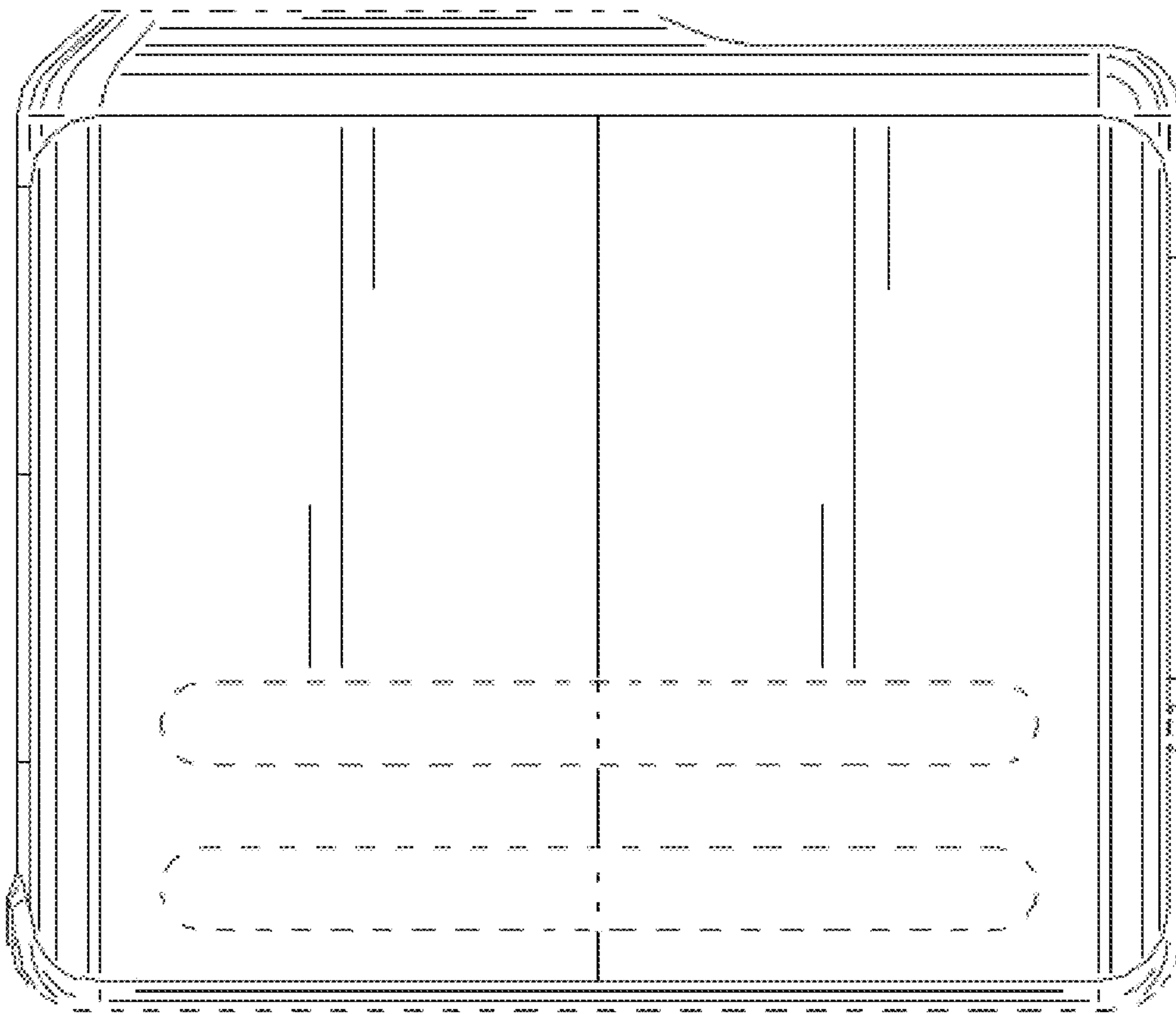

FIG. 5

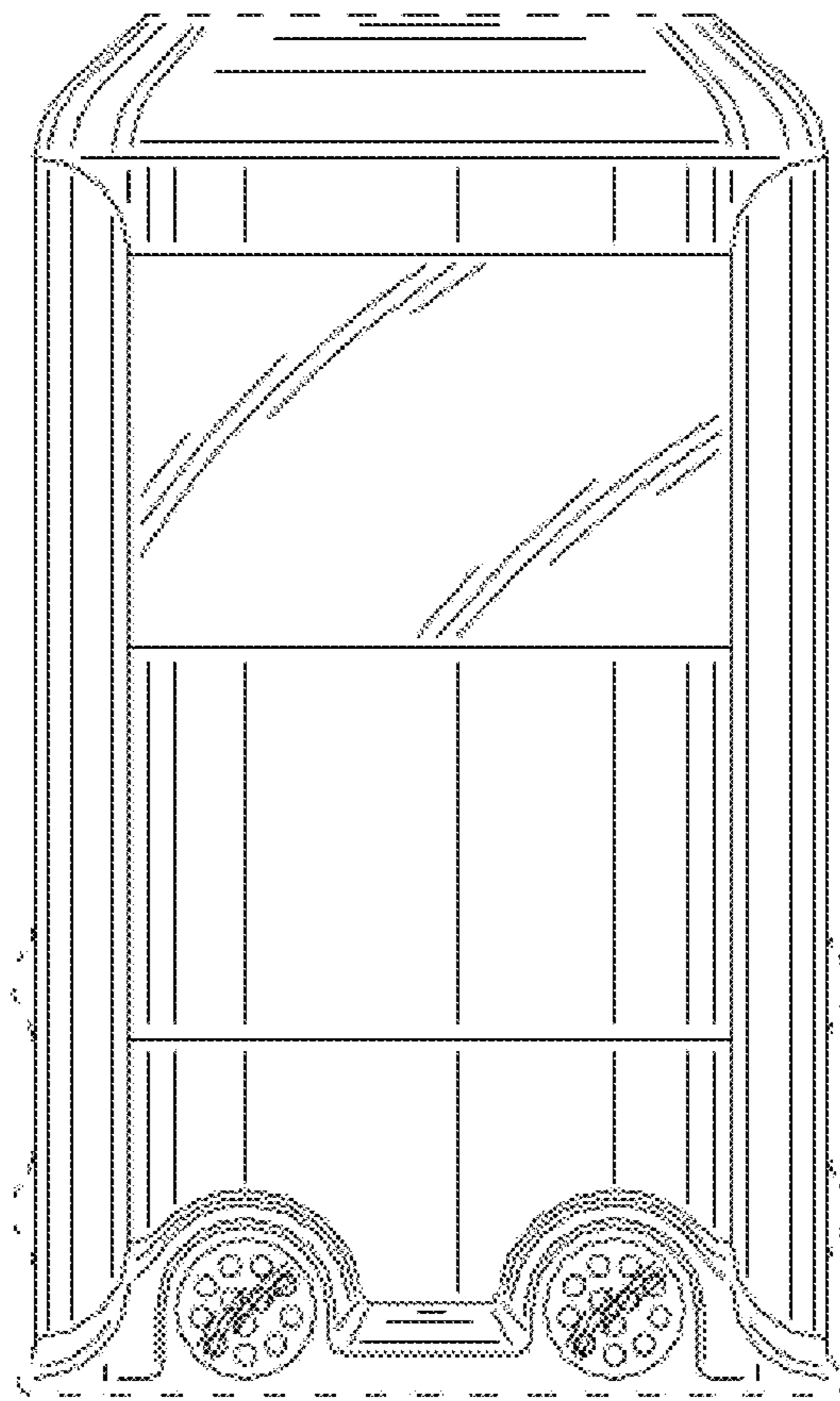

FIG. 6

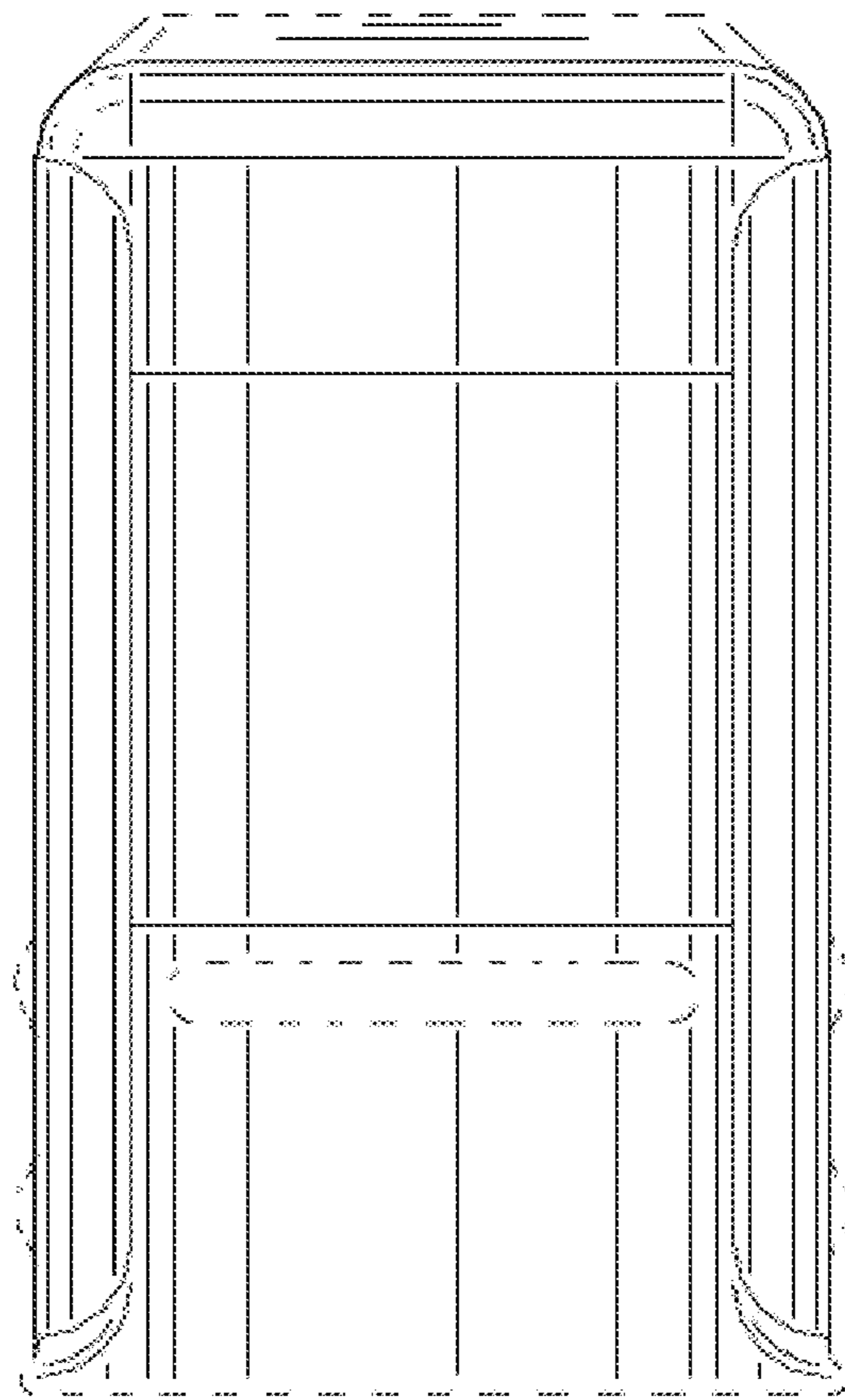

FIG. 7