



US00D911652S

(12) **United States Design Patent** (10) **Patent No.:** **US D911,652 S**  
**Boyea** (45) **Date of Patent:** **\*\* Feb. 23, 2021**

(54) **TRANSFORMATIVE EXTENDER**

(71) Applicant: **Christopher E. Boyea**, Burnt Hills, NY (US)

(72) Inventor: **Christopher E. Boyea**, Burnt Hills, NY (US)

(\*\*) Term: **15 Years**

(21) Appl. No.: **29/656,888**

(22) Filed: **Jul. 17, 2018**

(51) **LOC (13) Cl.** ..... **09-09**

(52) **U.S. Cl.**  
USPC ..... **D34/10**

(58) **Field of Classification Search**

USPC .... D34/1-2, 4-7, 10, 11; D9/435, 447, 434; 220/908, 908.1, 909; D20/27, 42, 43;  
(Continued)

(56) **References Cited**

U.S. PATENT DOCUMENTS

3,959,950 A \* 6/1976 Fukuda ..... B65B 5/04  
53/467  
4,915,678 A \* 4/1990 Morita ..... B31B 50/00  
493/116

(Continued)

*Primary Examiner* — Gino Colan

(74) *Attorney, Agent, or Firm* — Schmeiser, Olsen & Watts, LLP

(57) **CLAIM**

The ornamental design for a transformative extender, as shown and described.

**DESCRIPTION**

FIG. 1 is a front view of a transformative extender of my new design, in a first position;

FIG. 2 is perspective view thereof in a second position;

FIG. 3 is a perspective view thereof in a third position; FIG. 4 is a perspective view thereof in a fourth position; FIG. 5 is a perspective view thereof in a fifth position; FIG. 6 is a perspective view thereof in a sixth position; FIG. 7 is a perspective environmental view thereof in a seventh position; FIG. 8 is a bottom view thereof in an eighth position in which none of the top and bottom flaps are folded; FIG. 9 is a bottom view thereof in a ninth position in which one of the bottom flaps is folded; FIG. 10 is a bottom view thereof in a tenth position in which two of the bottom flaps are folded; FIG. 11 is a bottom thereof in an eleventh position in which three of the bottom flaps are folded; FIG. 12 is a bottom view thereof in a twelfth position in which all of the bottom flaps are folded; FIG. 13 is a bottom view thereof in a thirteenth position in which two of the bottom flaps are folded; FIG. 14 is a bottom view thereof in a fourteenth position in which three of the bottom flaps are folded; FIG. 15 is a bottom view thereof in a fifteenth position in which all of the bottom flaps are folded; FIG. 16 is a top view thereof in a sixteenth position in which none of the top and bottom flaps are folded; FIG. 17 is a top view thereof in a seventeenth position in which one of the top flaps is folded; FIG. 18 is a top view thereof in an eighteenth position in which two of the top flaps are folded; FIG. 19 is a top view thereof in a nineteenth position in which three of the top flaps are folded; FIG. 20 is a top view thereof in a twentieth position in which all of the top flaps are folded; FIG. 21 is a top view thereof in a twenty-first position in which two of the top flaps are folded; FIG. 22 is a top view thereof in a twenty-second position in which three of the top flaps are folded; and, FIG. 23 is a top view thereof in a twenty-third position in which all of the top flaps are folded.  
The broken lines shown in the figures are for the purpose of illustrating environment and form no part of the claimed design.

**1 Claim, 23 Drawing Sheets**

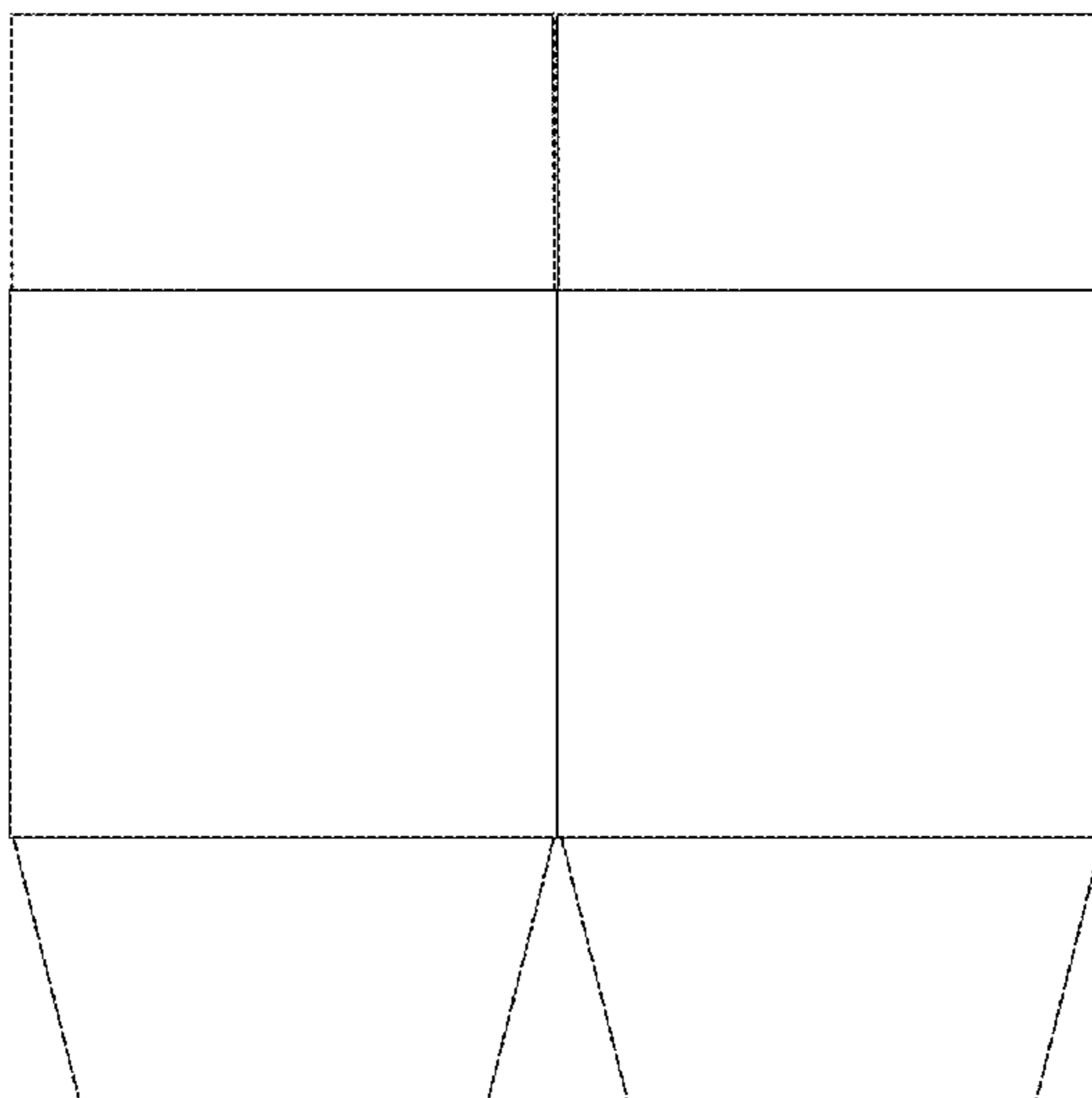

(58) **Field of Classification Search**

USPC ..... 53/377.3, 491, 467; 493/183, 162, 116,  
493/117, 101

CPC ... B65D 83/06; B31B 2110/35; B31B 50/004;  
B31B 50/0044; B31B 50/262; B31B  
50/00; B65B 7/20

See application file for complete search history.

(56) **References Cited**

U.S. PATENT DOCUMENTS

5,063,726 A \* 11/1991 Boisseau ..... B65B 7/20  
53/376.5  
5,115,625 A \* 5/1992 Barbulesco ..... B65B 5/024  
53/242  
5,285,957 A \* 2/1994 Halsell ..... B32B 29/02  
229/199  
5,480,371 A \* 1/1996 Morita ..... B31B 50/00  
493/117  
6,951,530 B2 \* 10/2005 Toth ..... B65B 7/20  
493/101  
8,092,360 B2 \* 1/2012 Greenfield ..... B65D 5/0281  
493/162  
8,297,029 B2 \* 10/2012 Iwasa ..... B31B 50/00  
493/183  
9,073,279 B2 \* 7/2015 Pettersson ..... B65B 43/54  
9,227,373 B2 \* 1/2016 Pettersson ..... B31B 50/726  
9,290,281 B2 \* 3/2016 Iwasa ..... B65B 7/20  
D804,134 S \* 11/2017 Boyea ..... D34/10  
10,343,364 B1 \* 7/2019 Davis ..... B31B 50/624

\* cited by examiner

FIG. 1

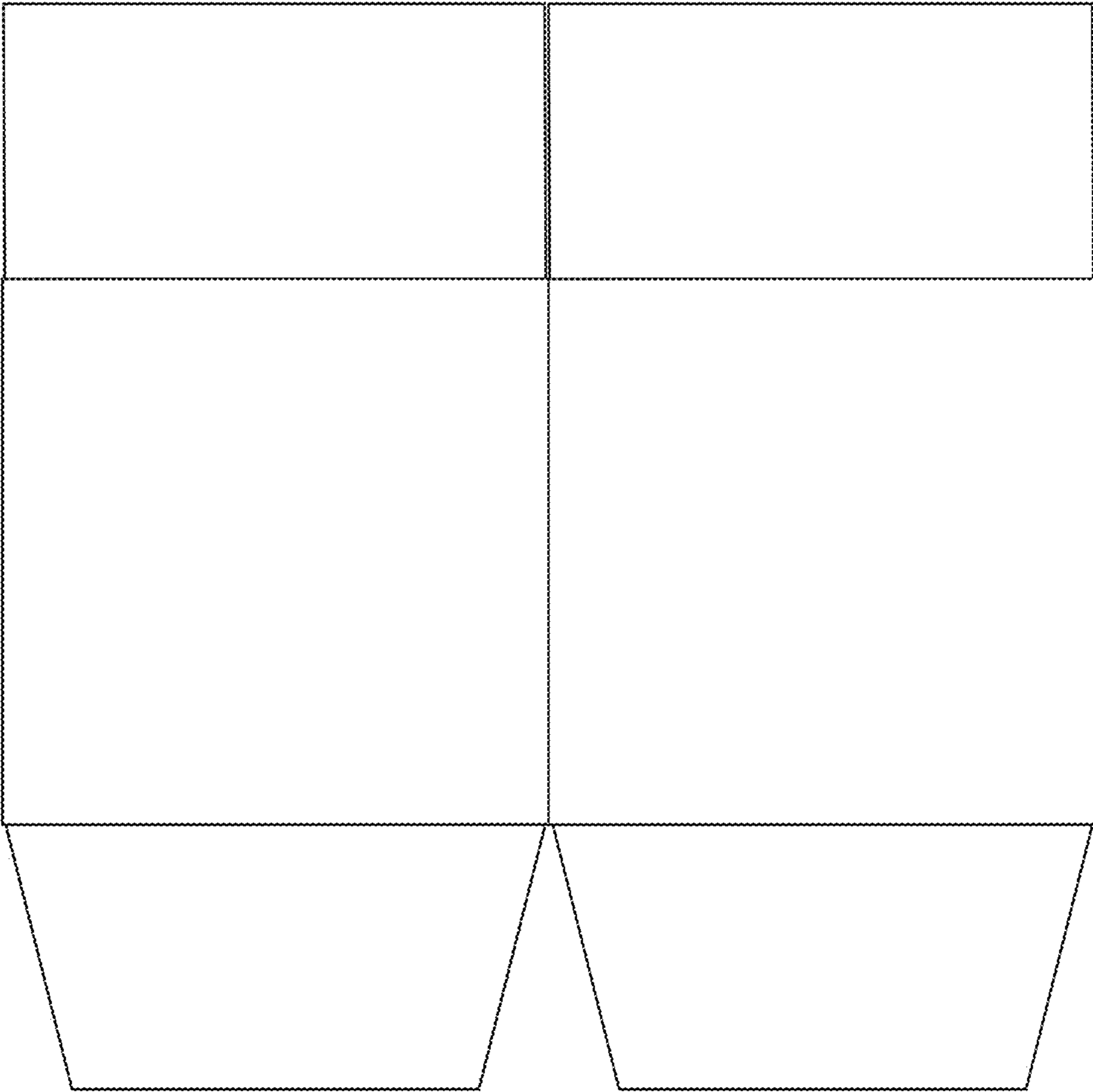

FIG. 2

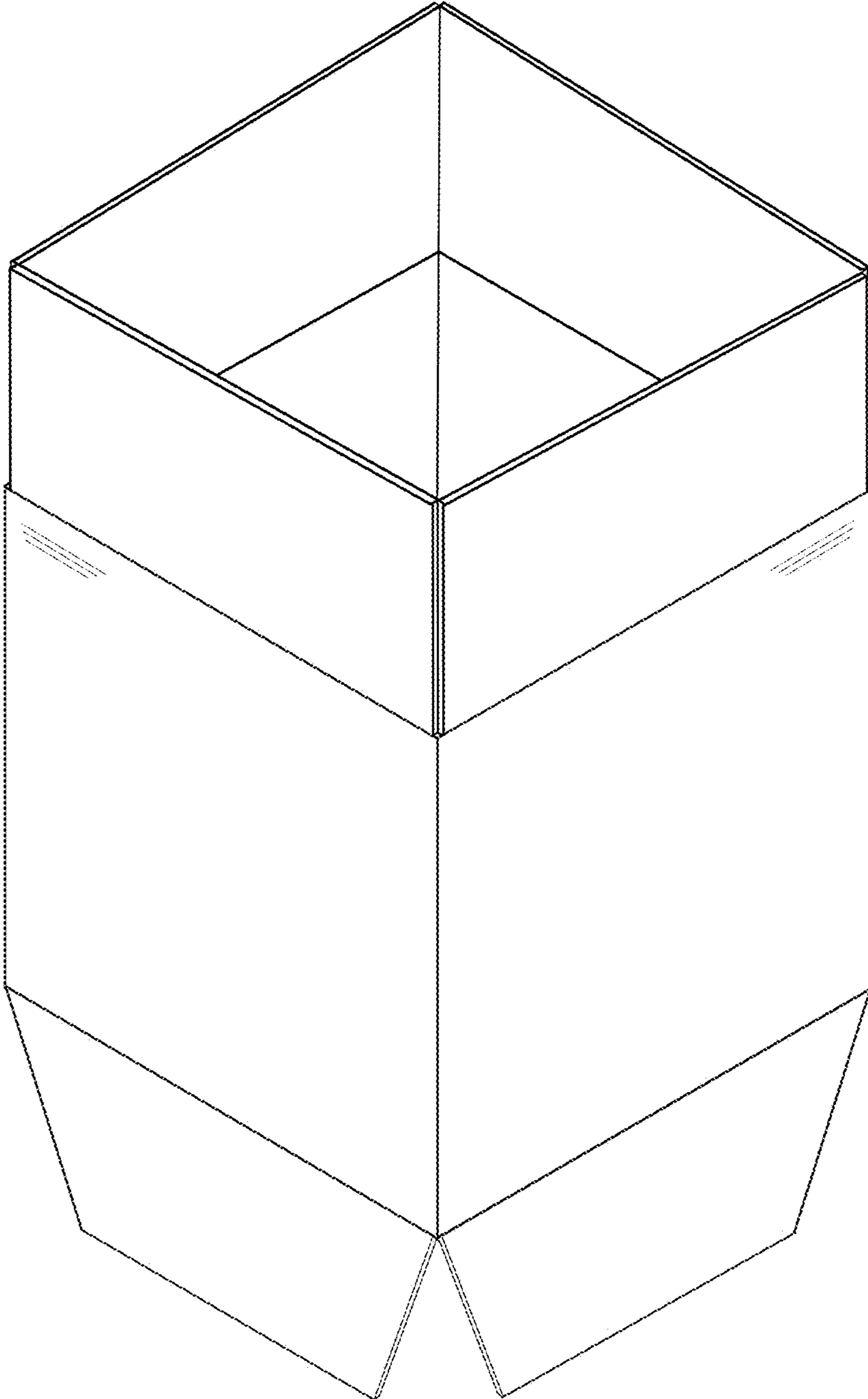

FIG. 3

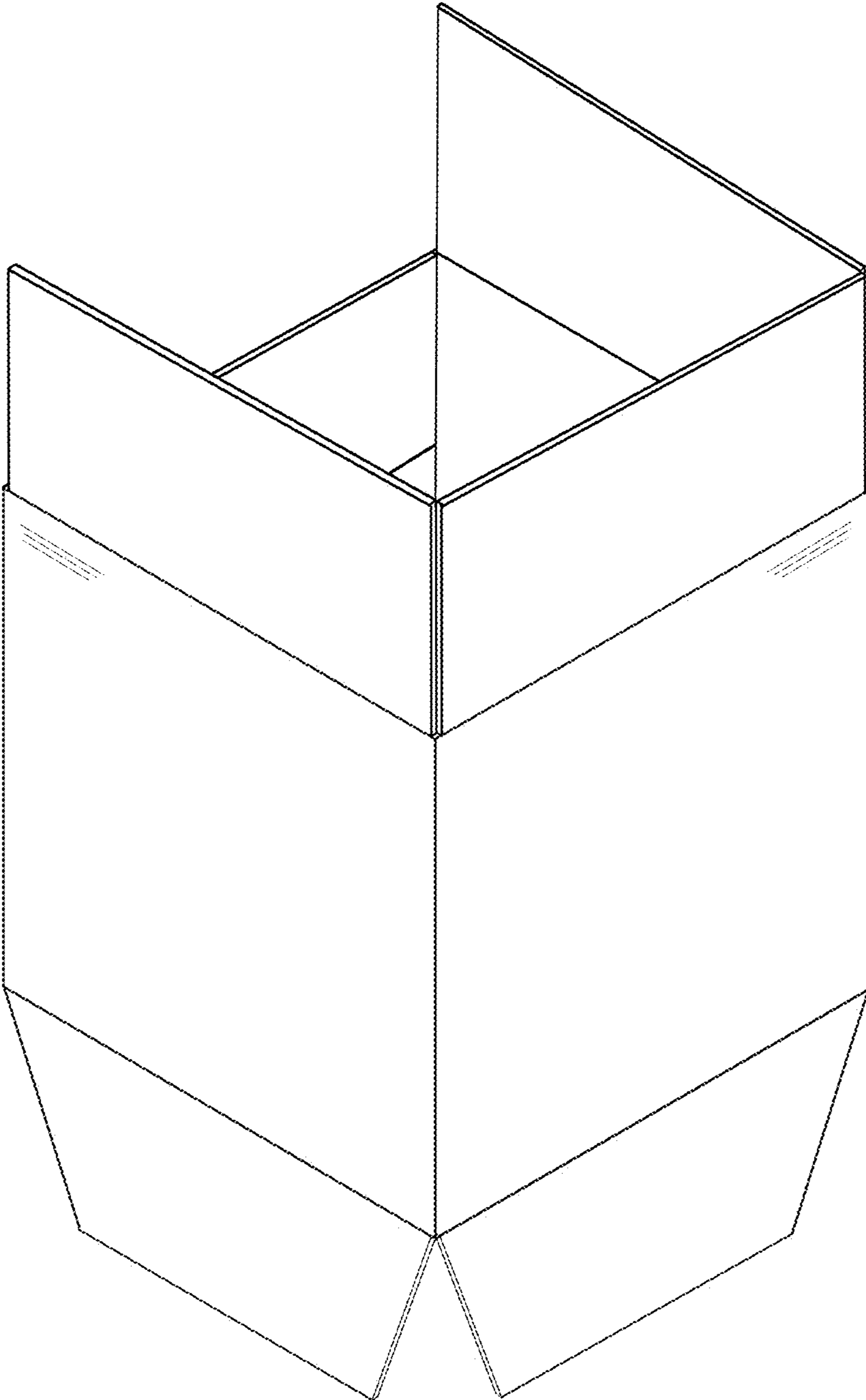

FIG. 4

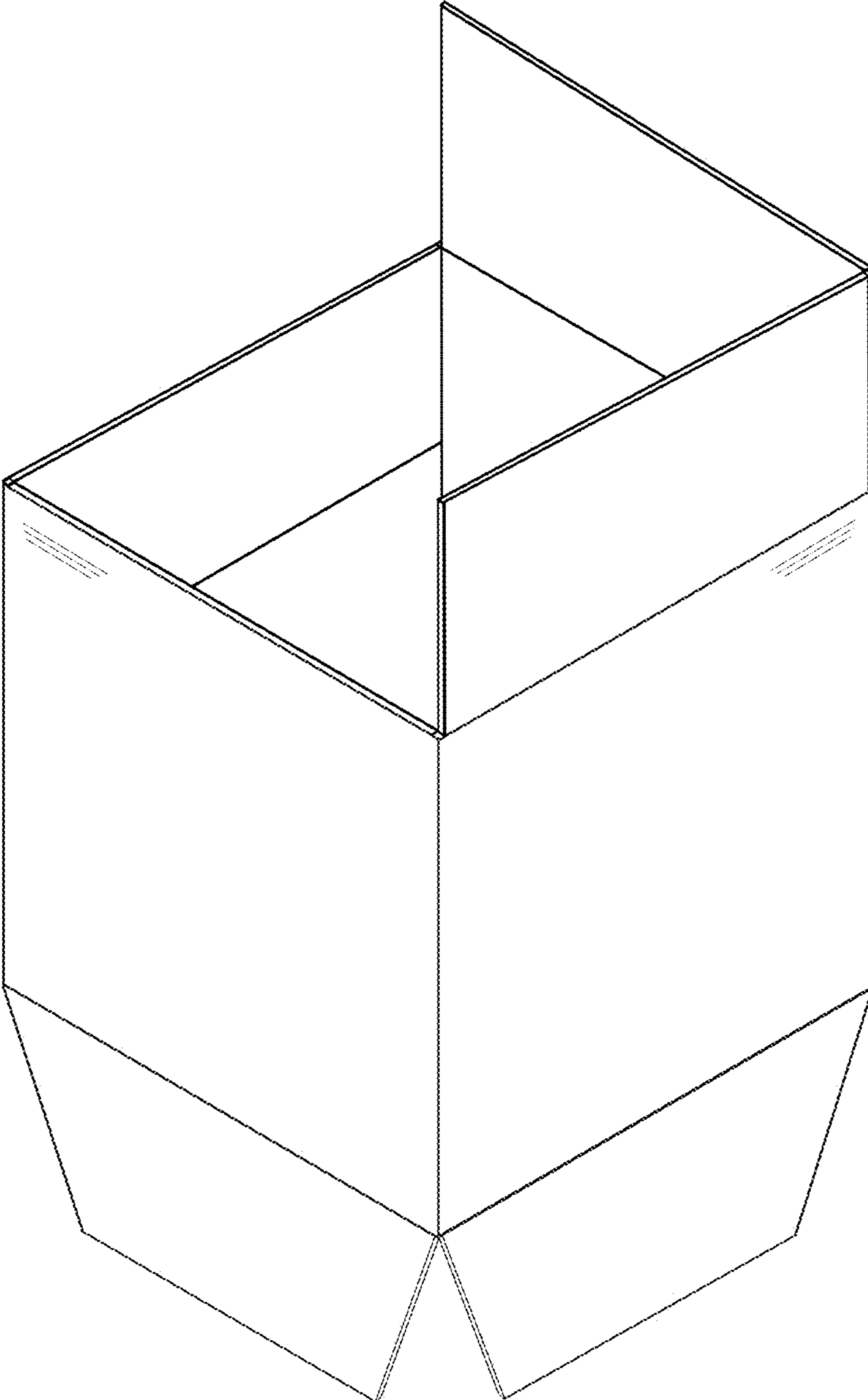

FIG. 5

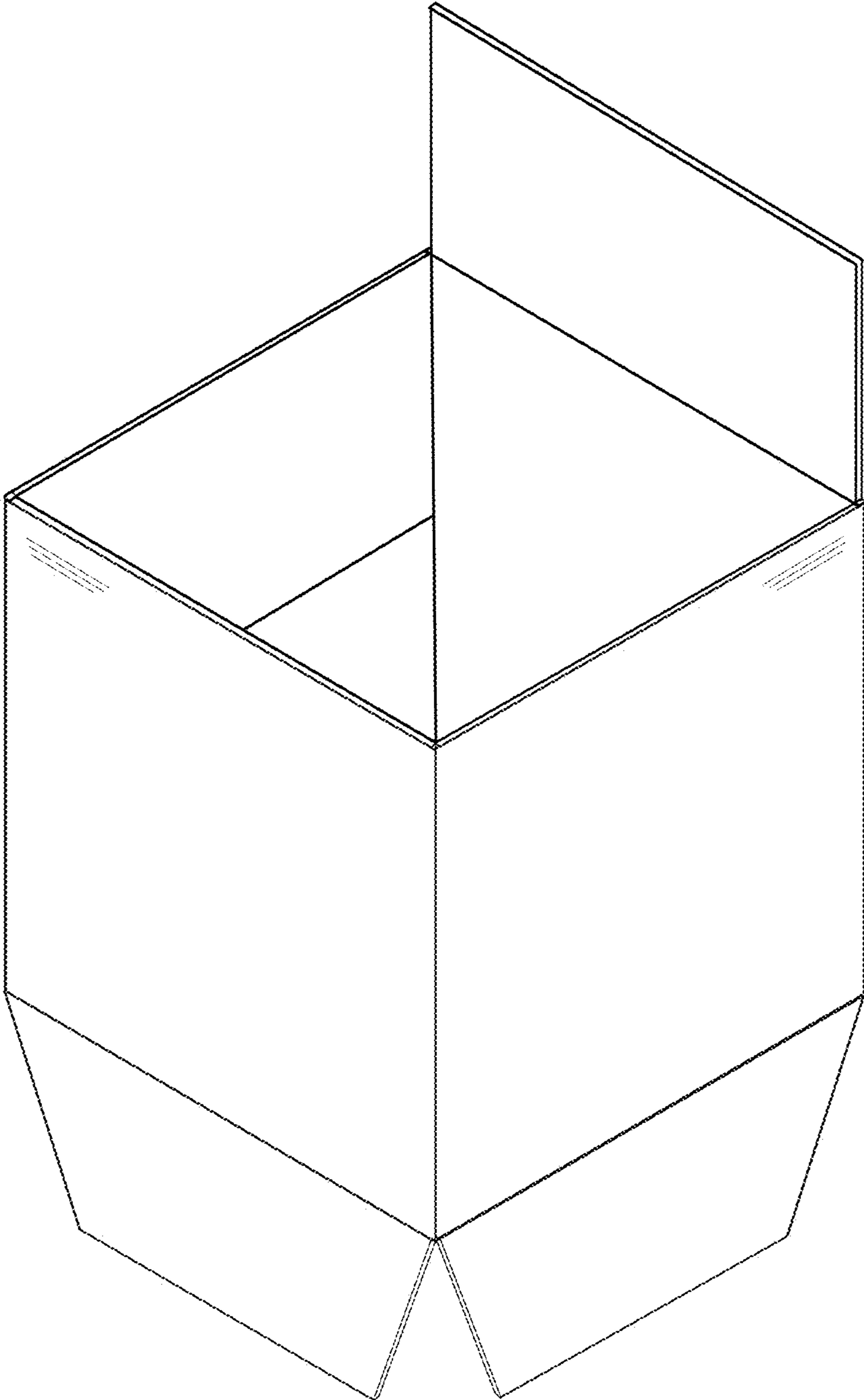

FIG. 6

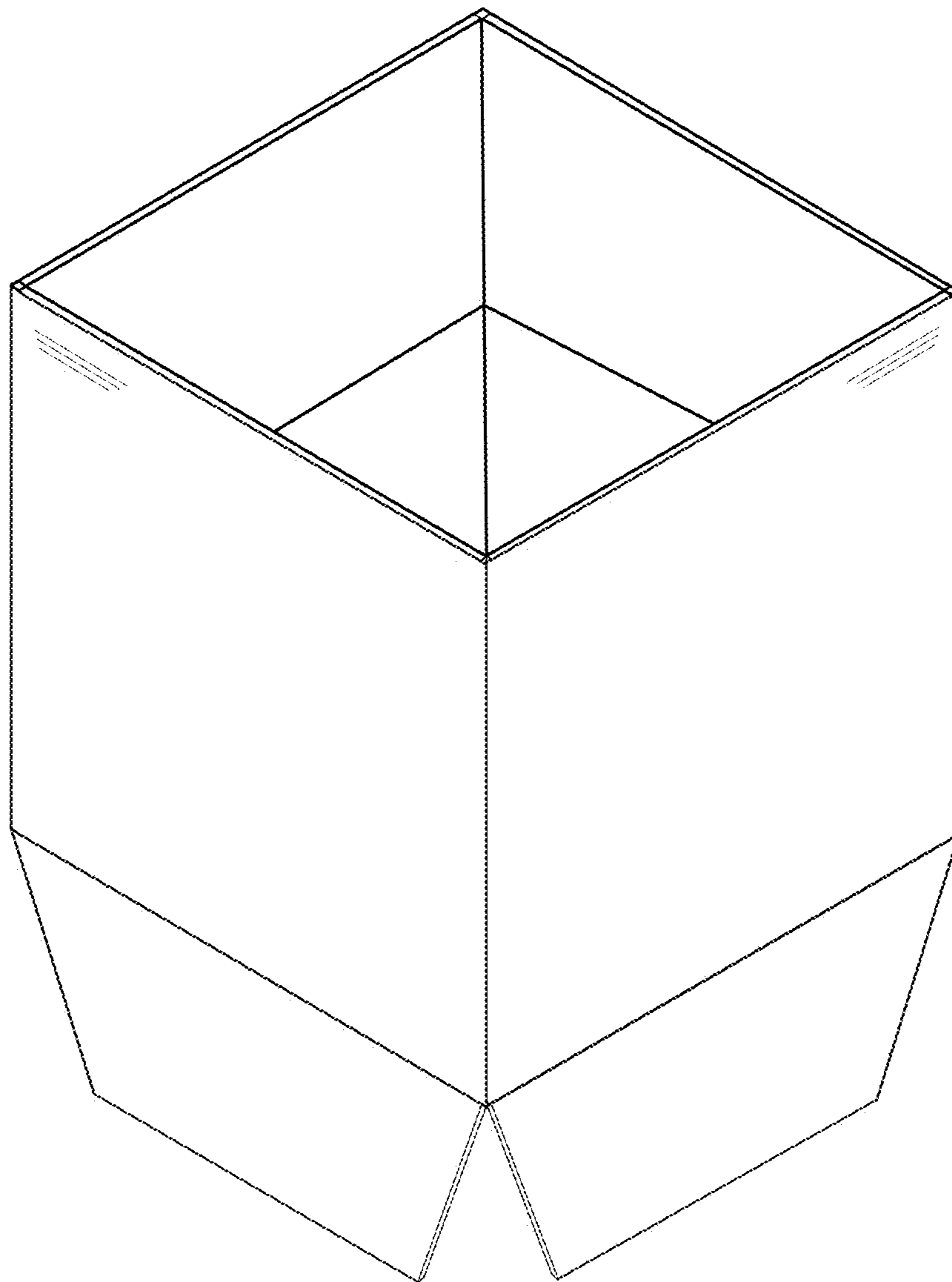



FIG. 7

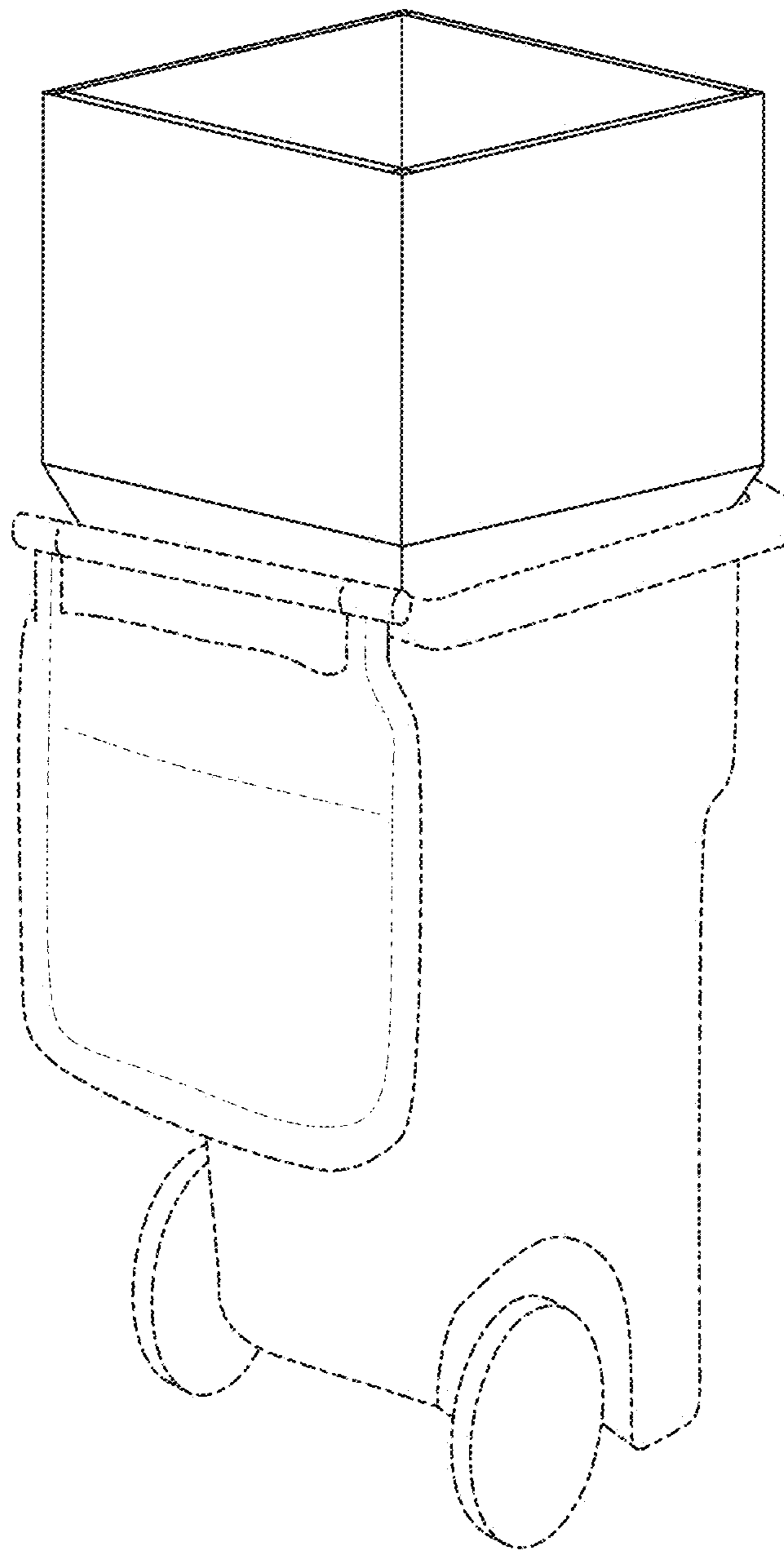

FIG. 8

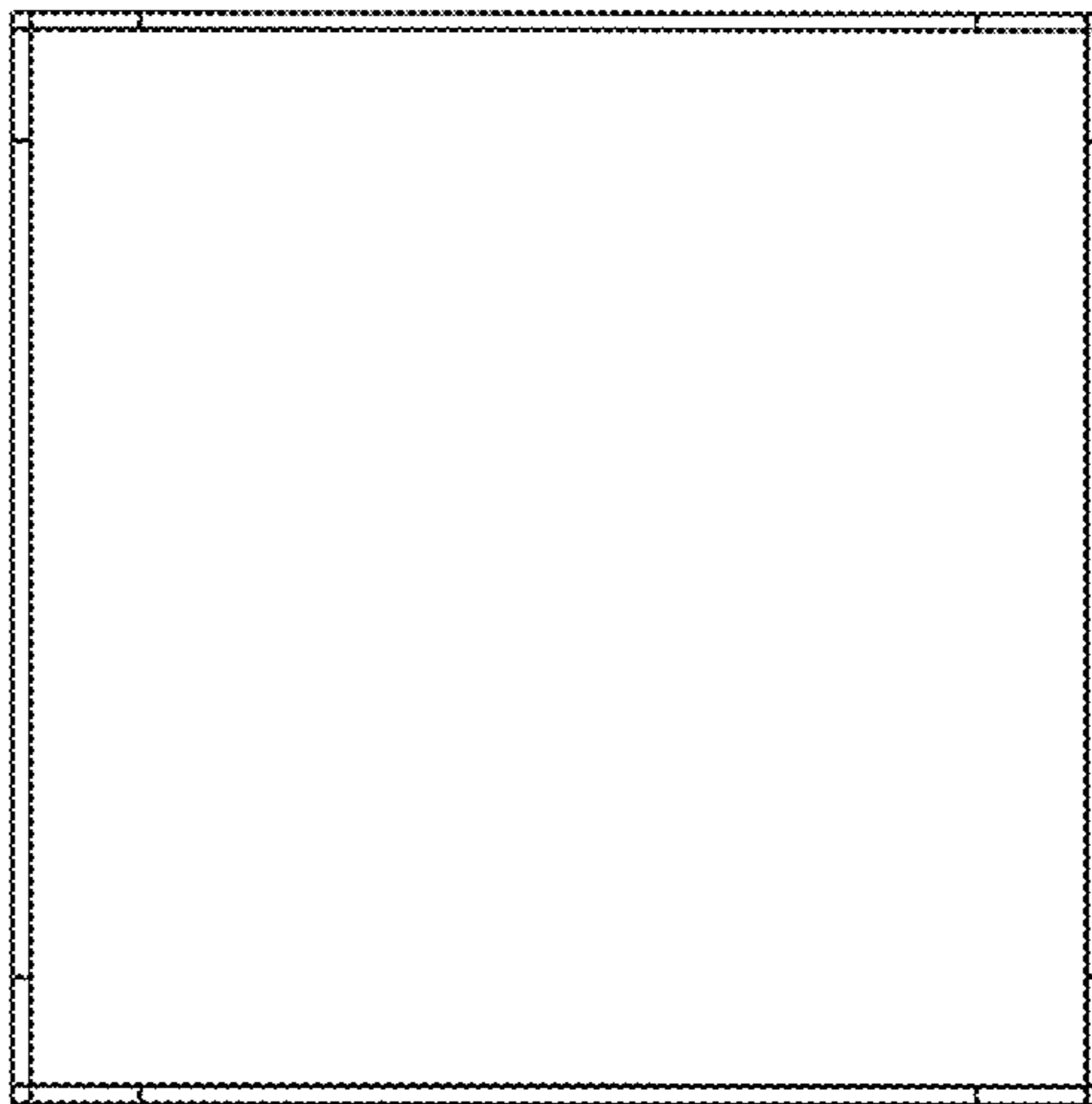

FIG.9

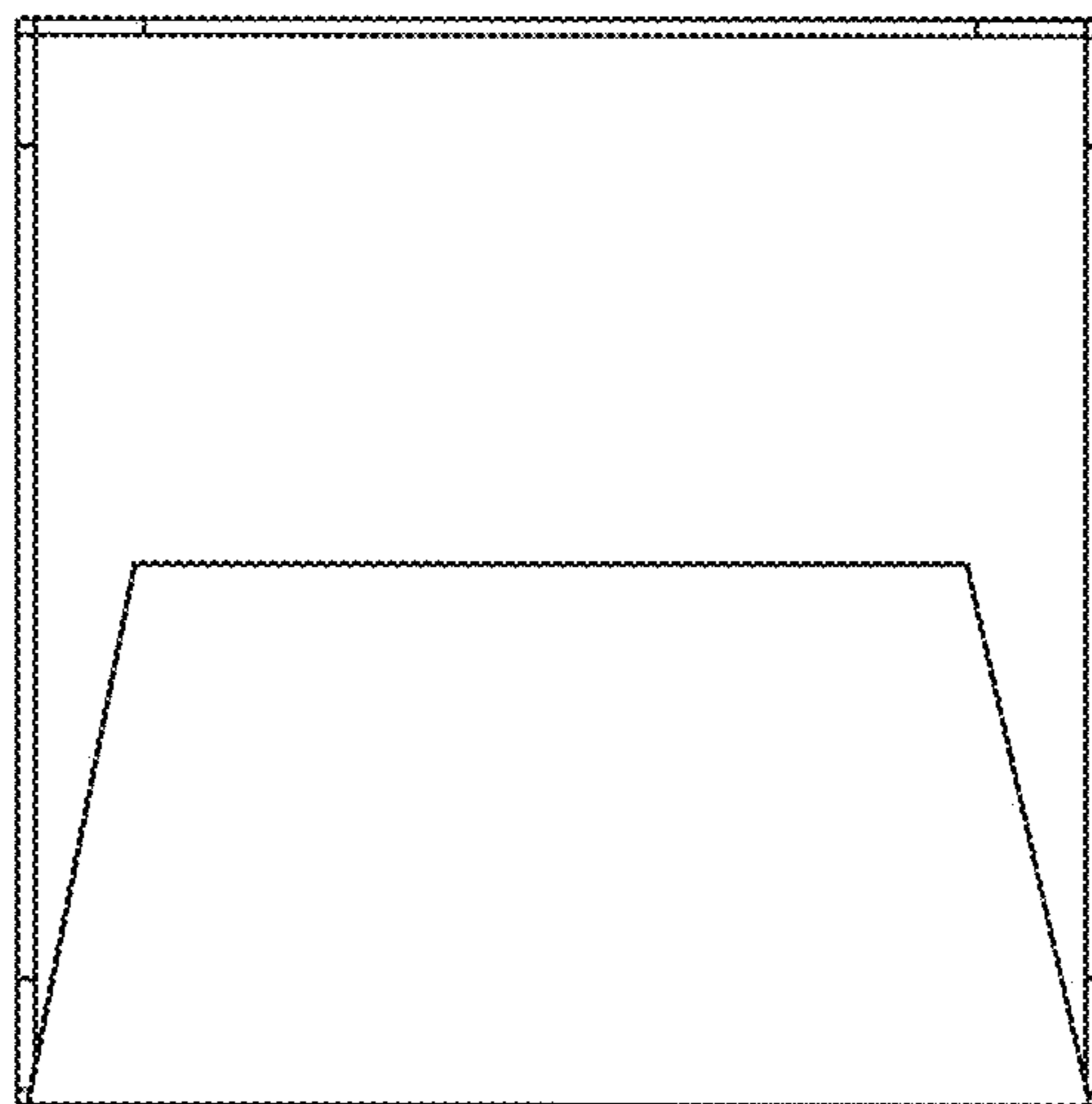

FIG. 10

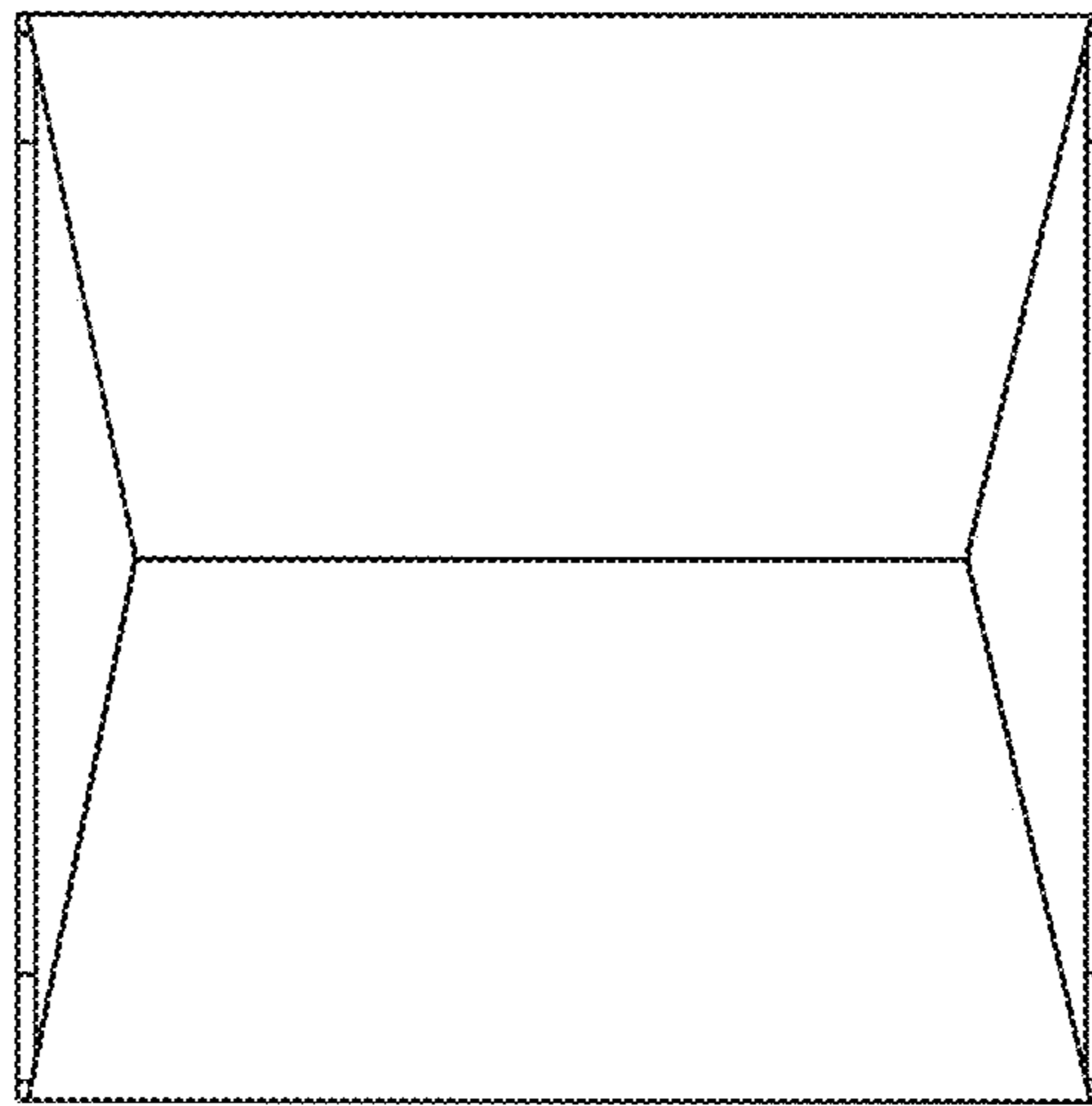

FIG. 11

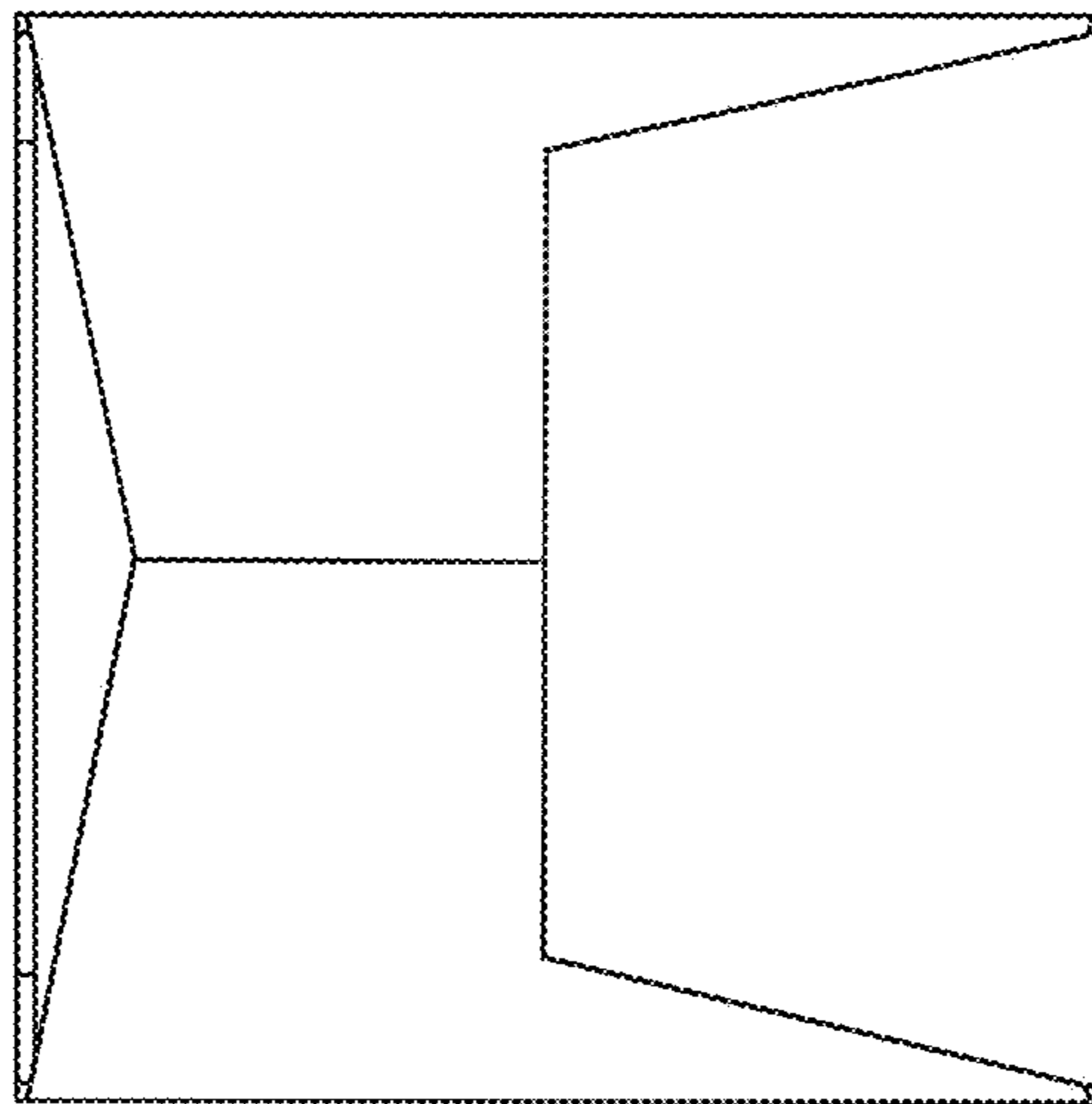

FIG. 12

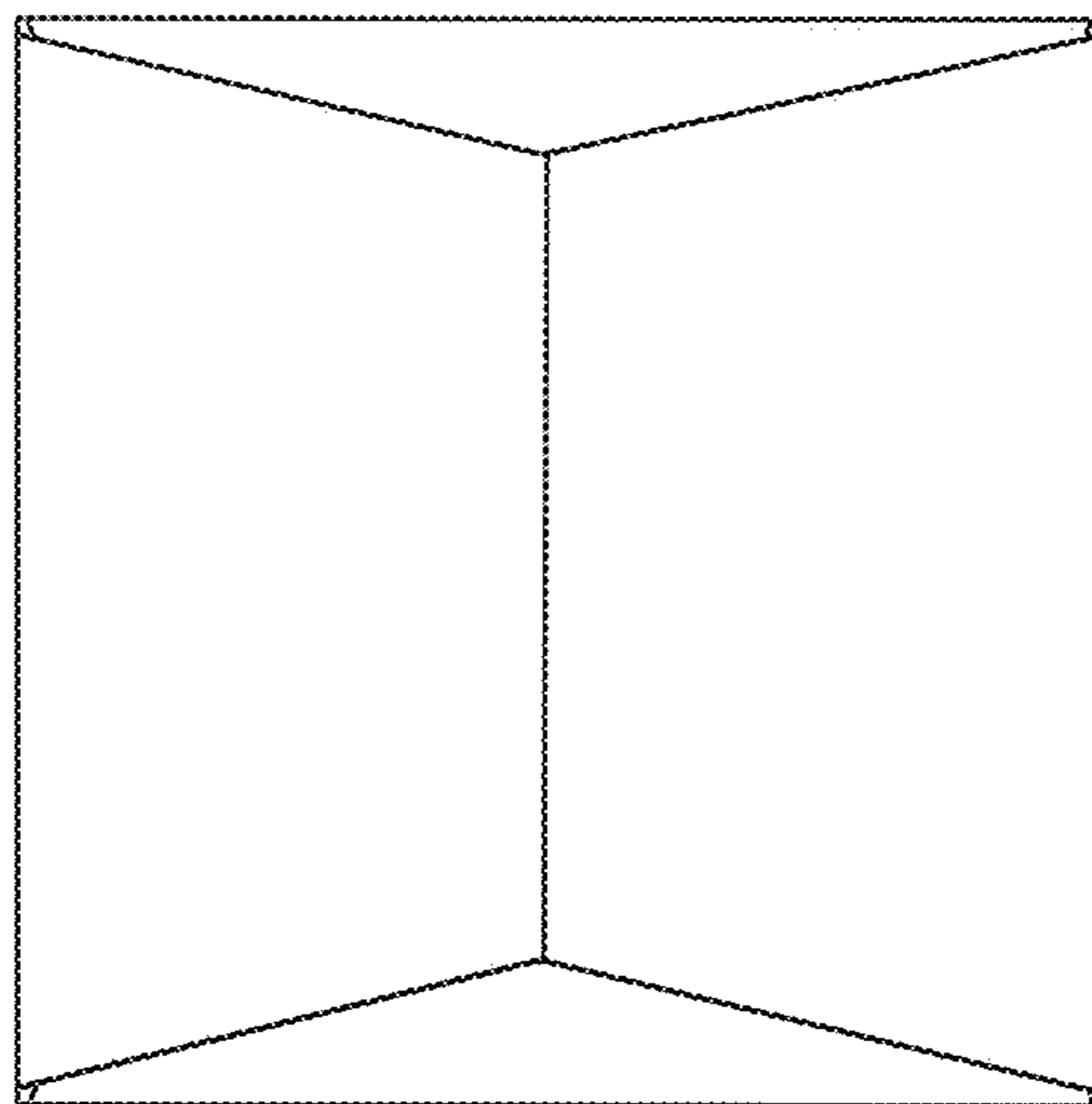

FIG. 13

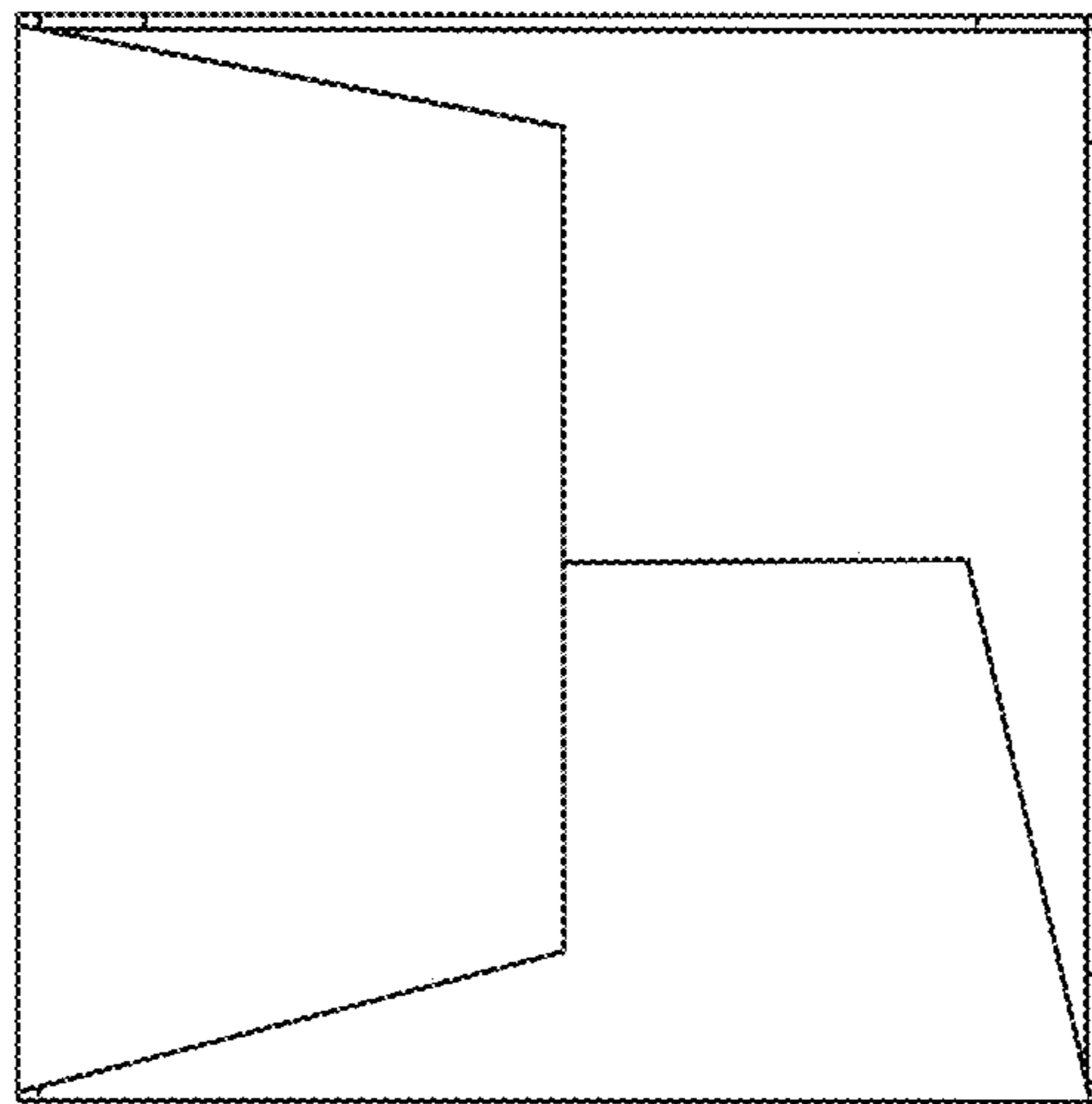

FIG. 14

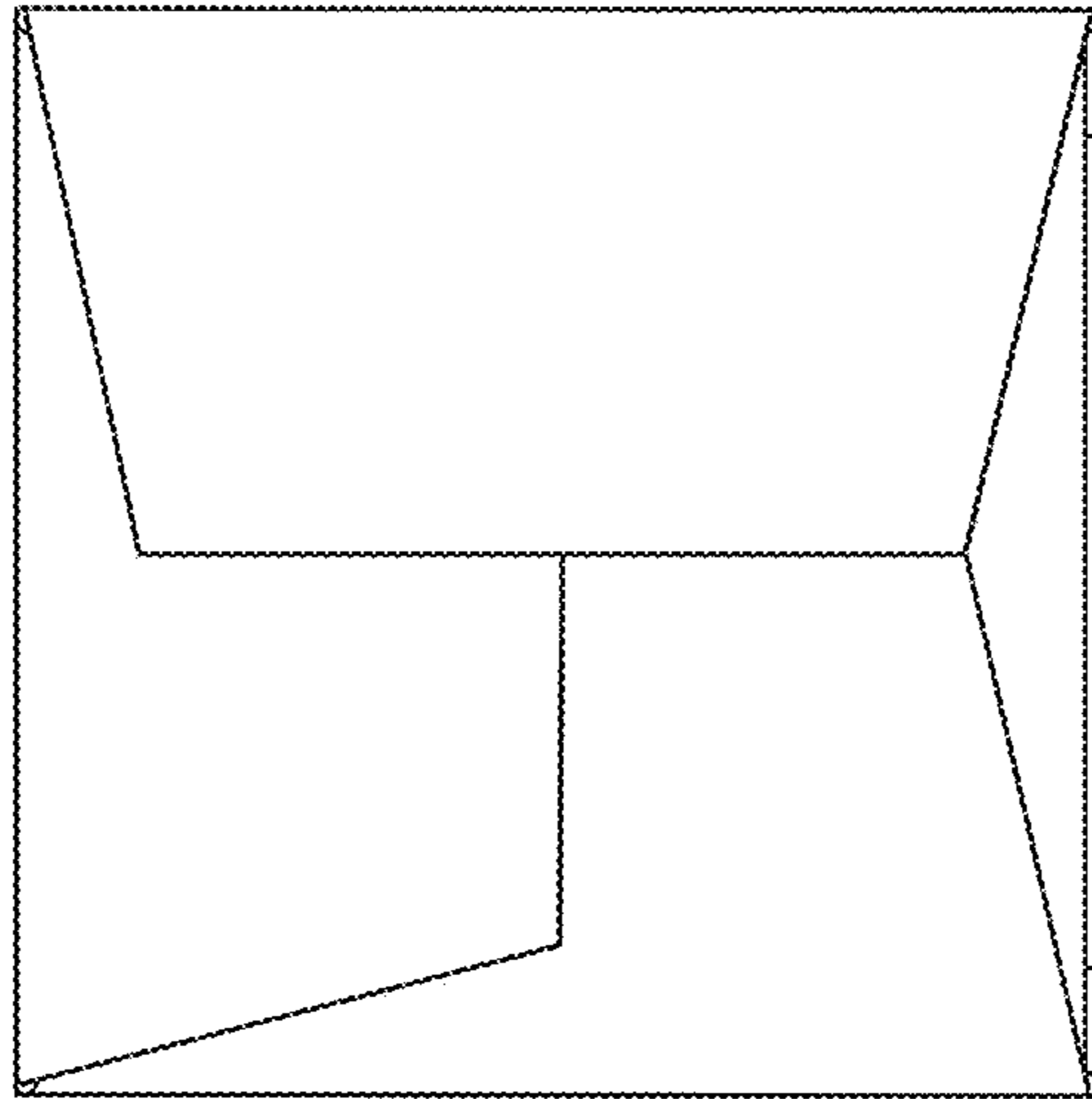



FIG. 15

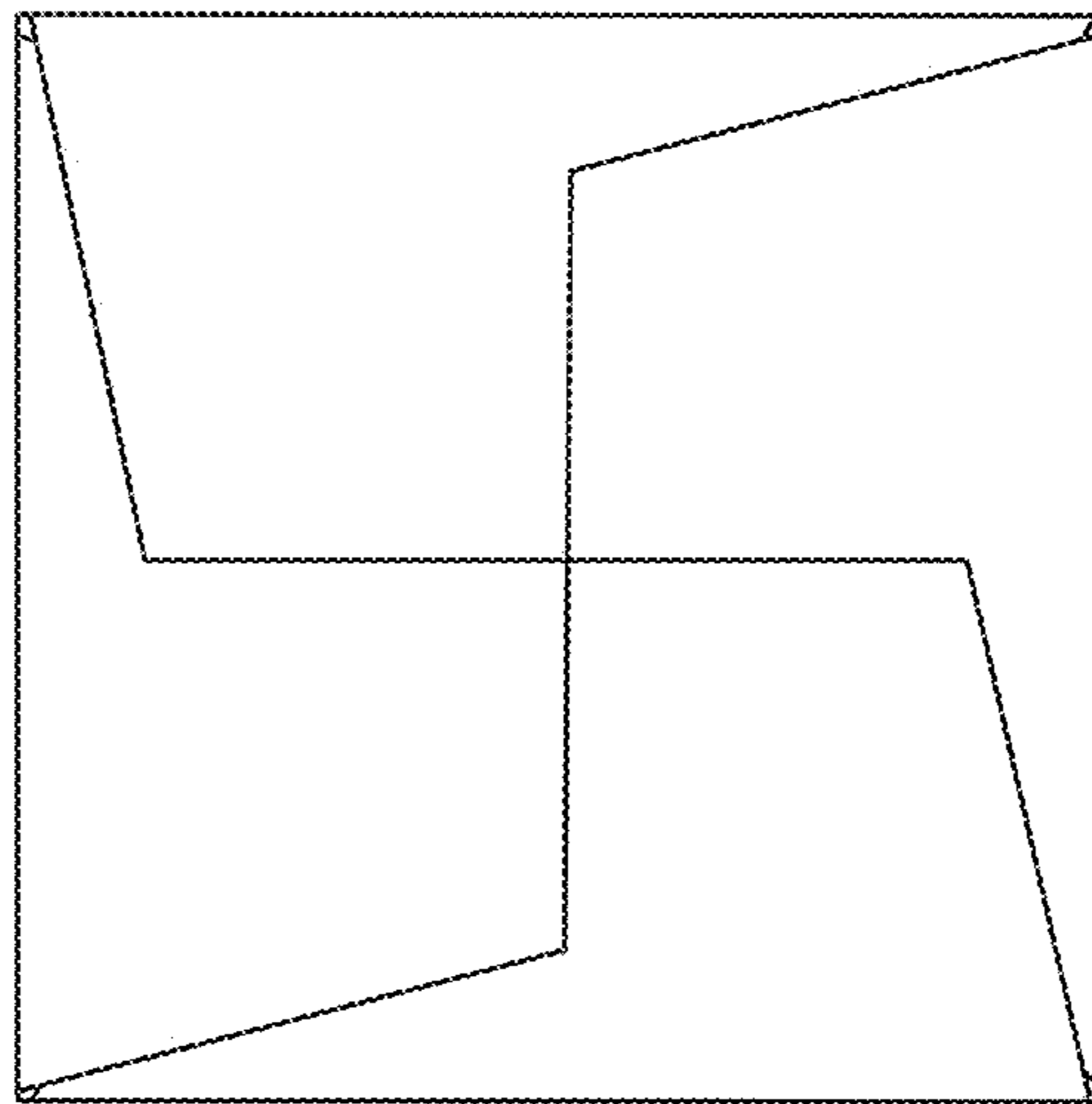

FIG. 16

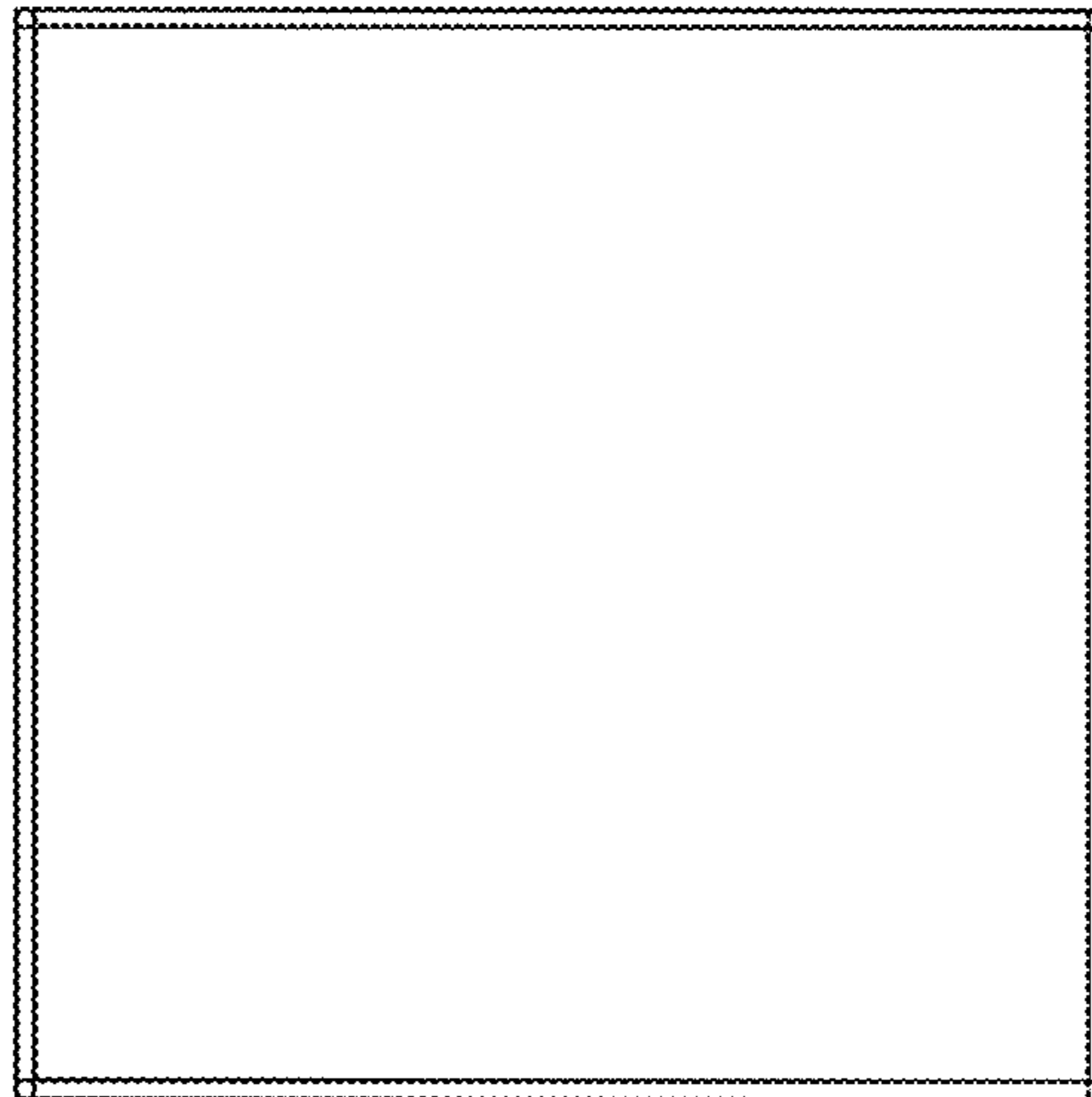

FIG. 17

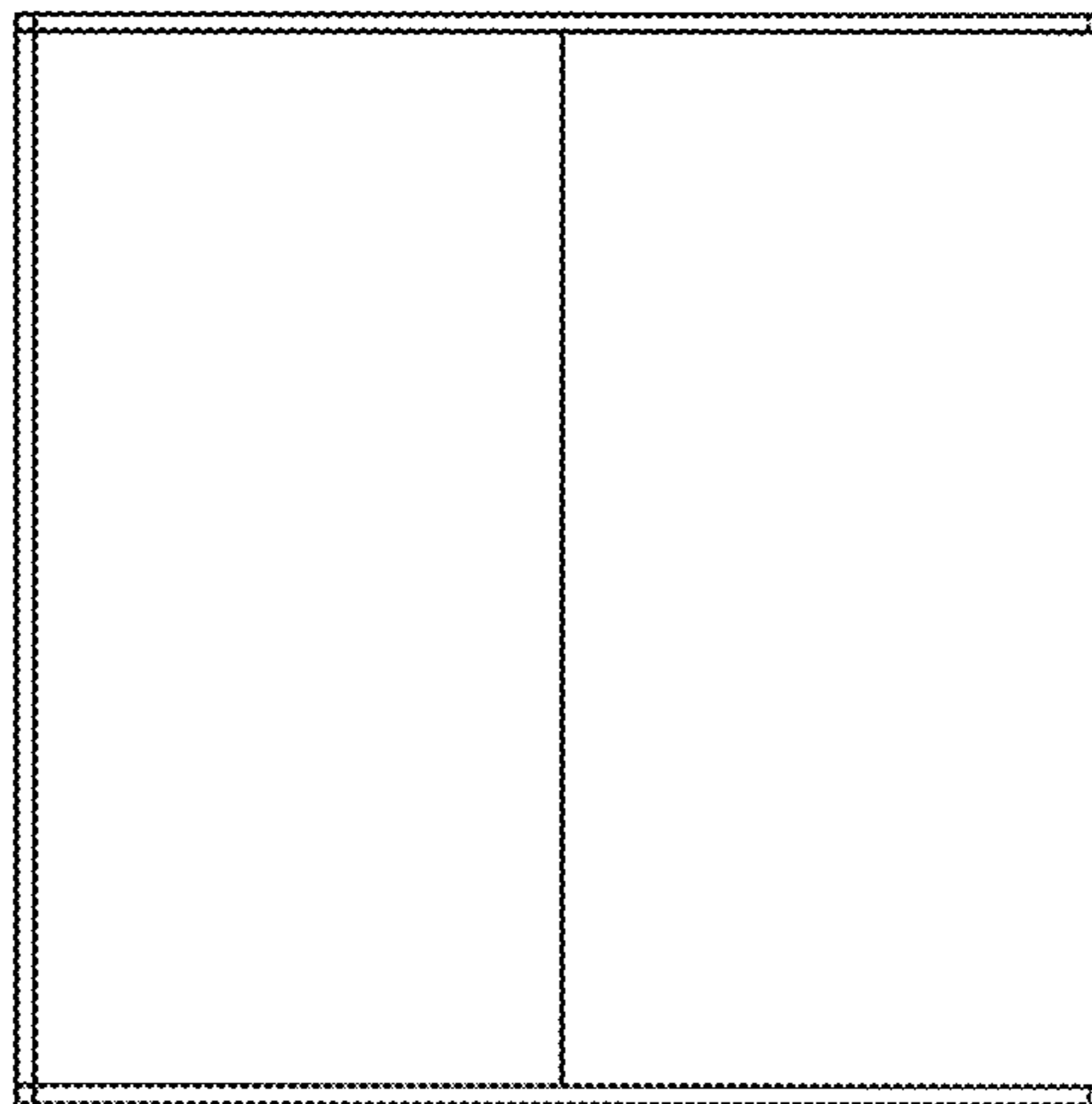

FIG. 18

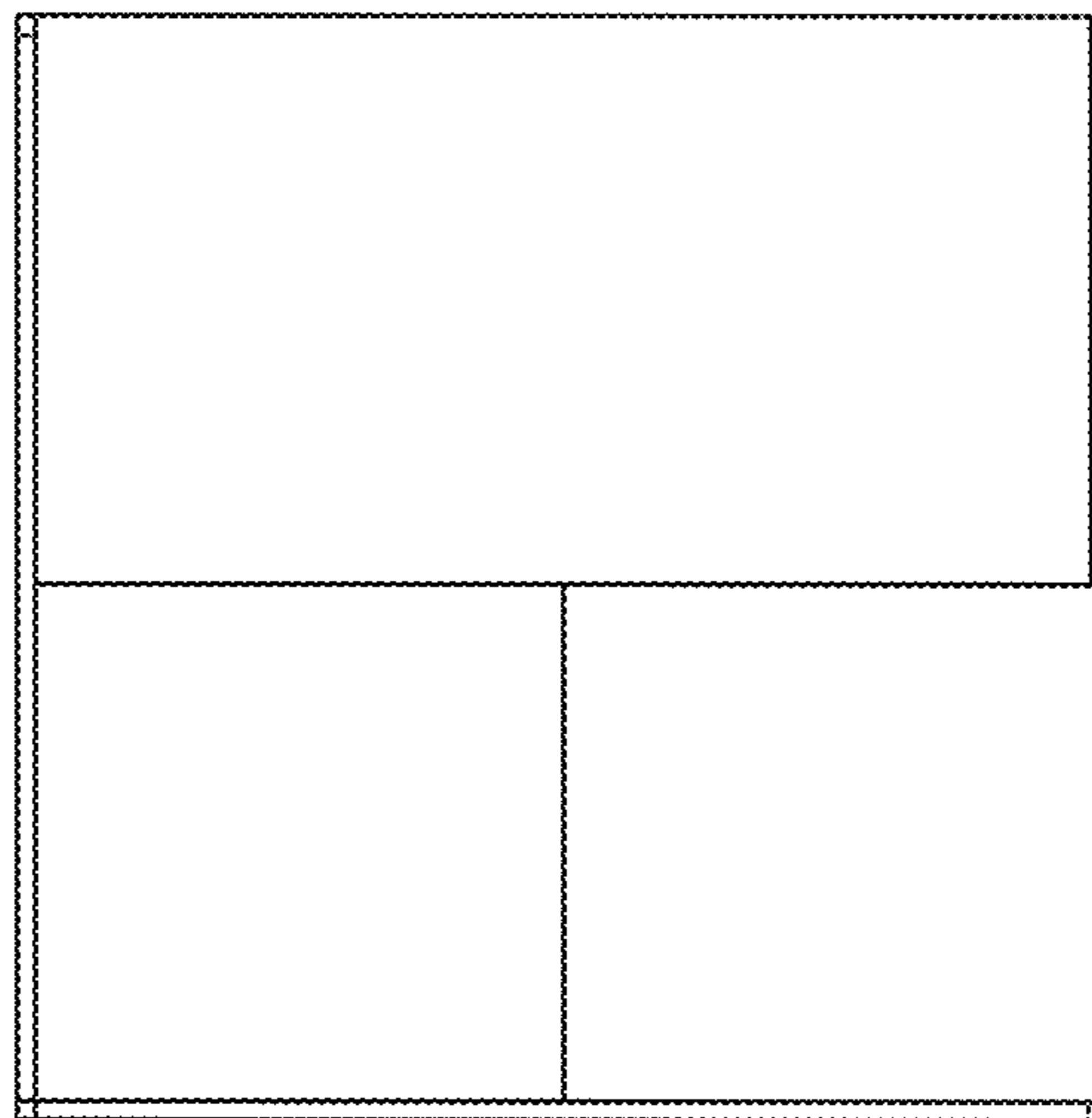

FIG. 19

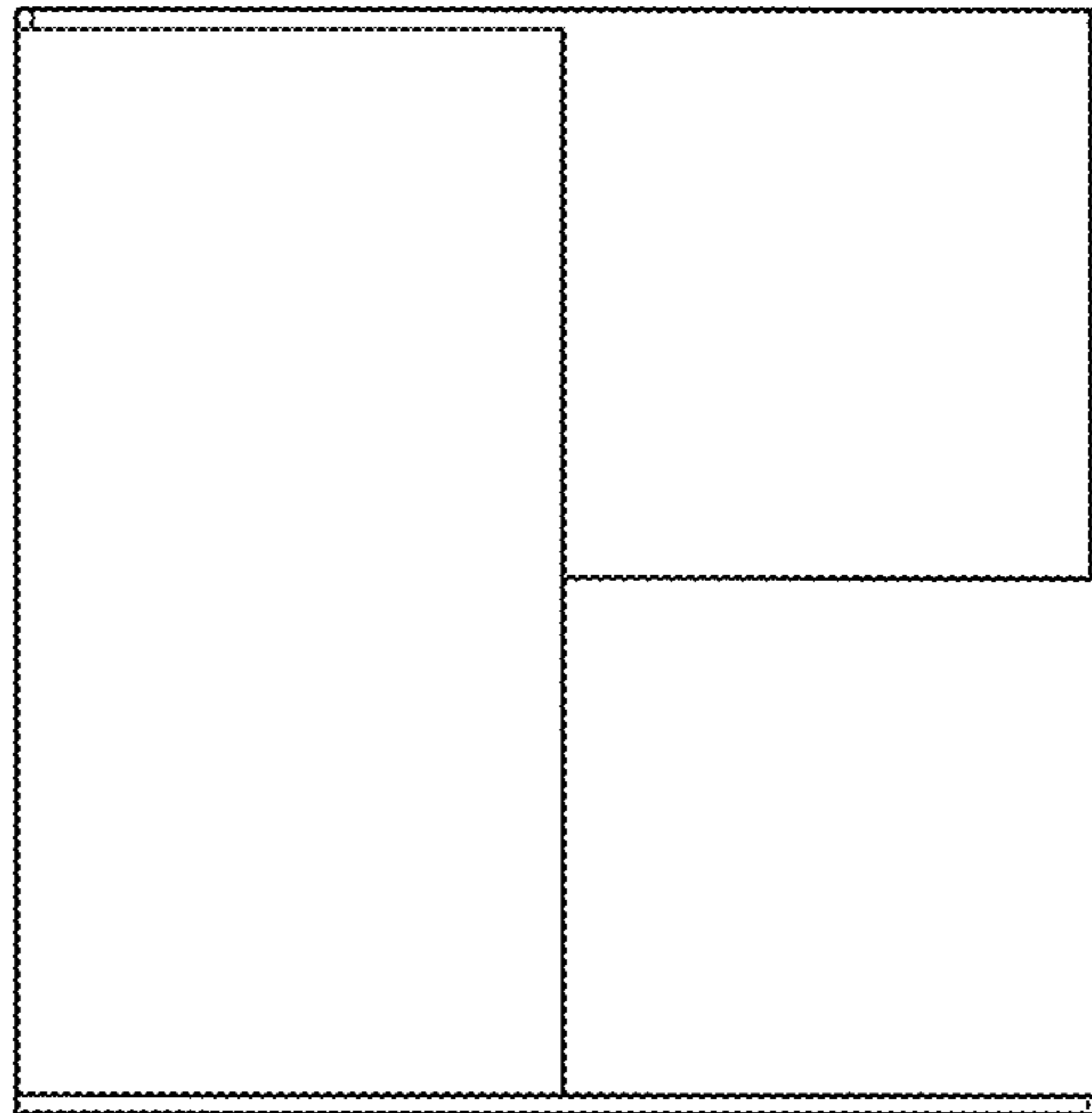

FIG. 20

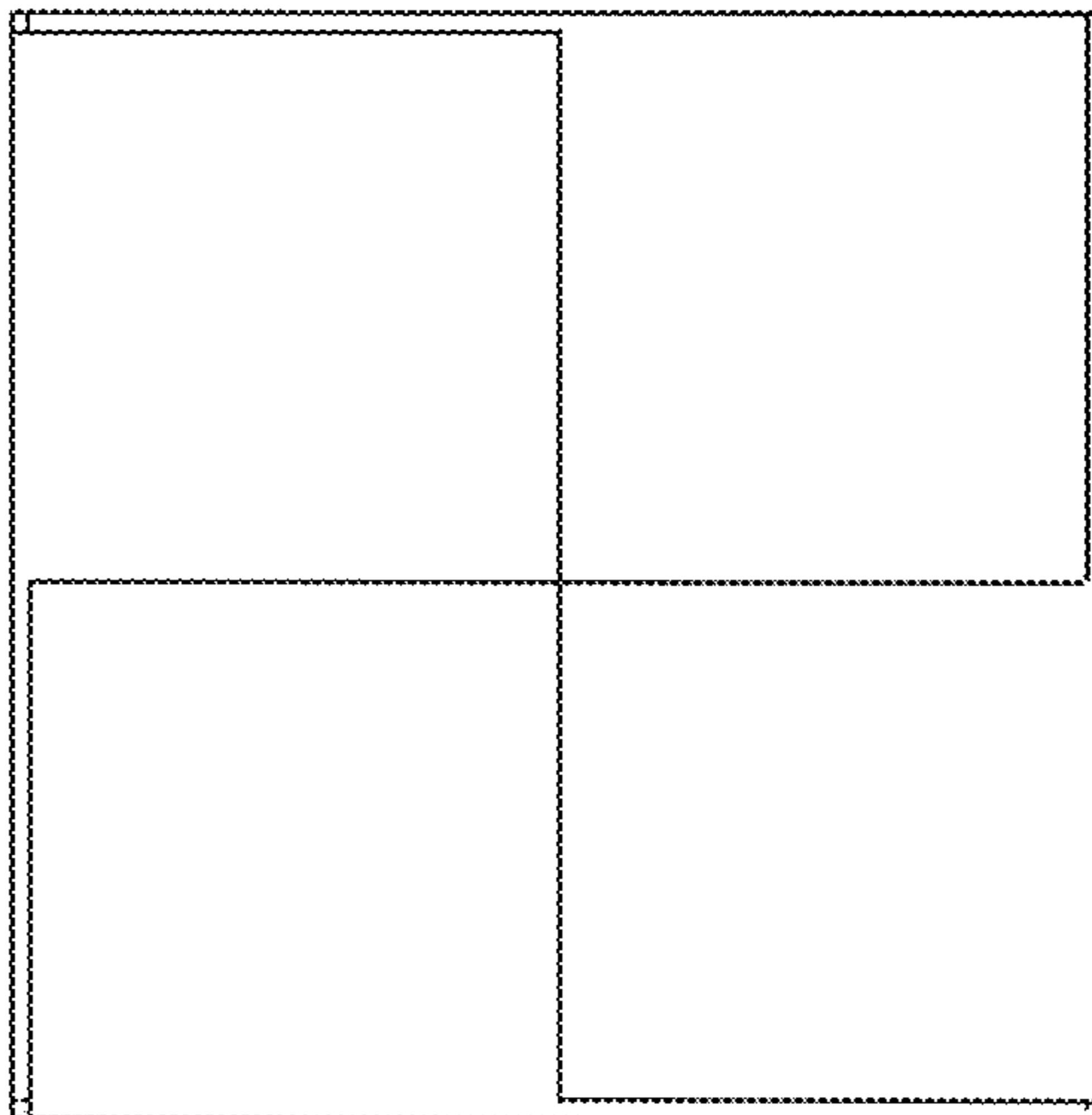

FIG. 21

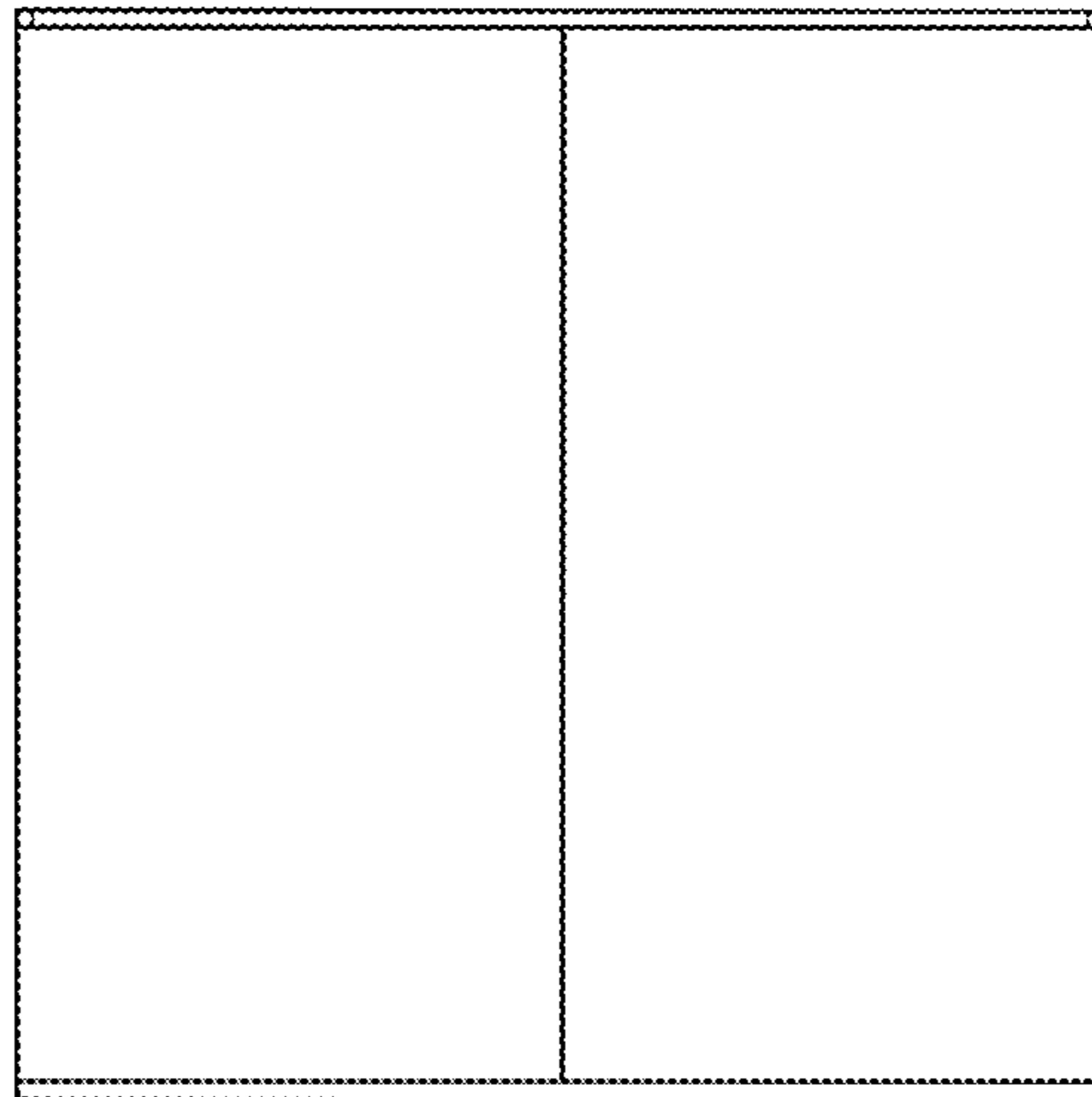

FIG. 22

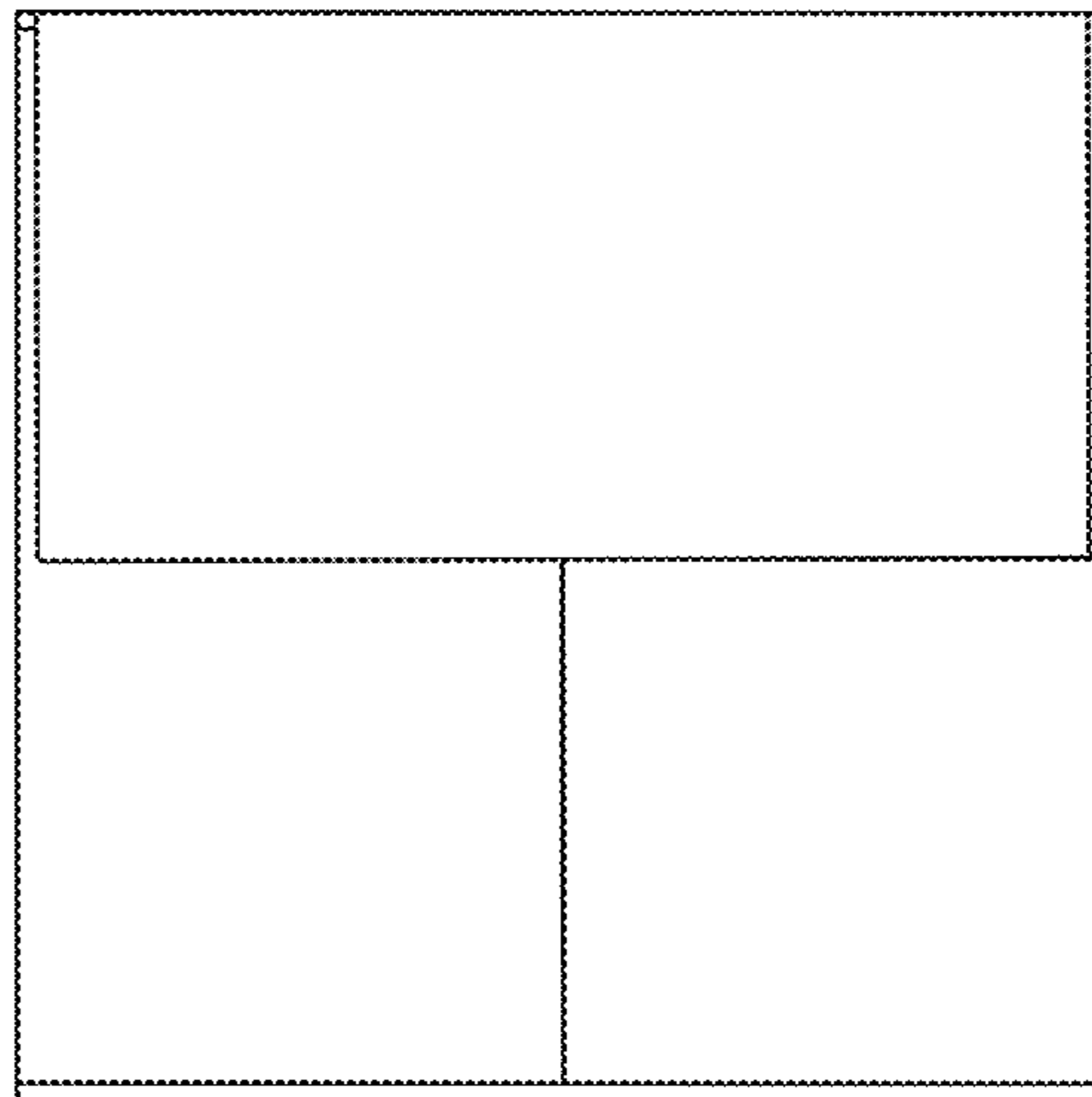



FIG. 23

