



US00D911640S

(12) **United States Design Patent** (10) **Patent No.:** **US D911,640 S**  
**Schuetz et al.** (45) **Date of Patent:** **\*\* Feb. 23, 2021**

(54) **TRAILER MOUNTED PRESSURE WASHER**

D467,692 S \* 12/2002 Morgan ..... D32/15  
D473,494 S 4/2003 Lieberman  
6,715,195 B2 4/2004 Erickson  
D532,942 S \* 11/2006 Busschaert ..... D32/15

(71) Applicant: **Northern Tool & Equipment Company, Inc.**, Burnsville, MN (US)

(Continued)

(72) Inventors: **John Schuetz**, Owatonna, MN (US);  
**Timothy Rancourt**, Lakeville, MN (US); **Joseph DeGezelle**, Lakeville, MN (US); **Kyle Hecimovich**, Lonsdale, MN (US); **Nicholas Rancourt**, Minneapolis, MN (US)

FOREIGN PATENT DOCUMENTS

AU 201812030 1/2018  
AU 201812032 1/2018

(Continued)

(73) Assignee: **NORTHERN TOOL & EQUIPMENT COMPANY, INC.**, Burnsville, MN (US)

OTHER PUBLICATIONS

NorthStar ProShot Hot Water Commercial Pressure Washer Trailer—3000 PSI, website 2019, site visited Dec. 4, 2019, [https://www.northerntool.com/shop/tools/product\\_200732884\\_200732884](https://www.northerntool.com/shop/tools/product_200732884_200732884).\*

(Continued)

(\*\*) Term: **15 Years**

*Primary Examiner* — John R Yeh

(21) Appl. No.: **29/642,887**

(74) *Attorney, Agent, or Firm* — Fafinski Marks Johnson, P.A.

(22) Filed: **Apr. 3, 2018**

(51) **LOC (13) Cl.** ..... **15-05**

(52) **U.S. Cl.**  
USPC ..... **D32/16**

(58) **Field of Classification Search**  
USPC ..... D32/15–19, 50–52, 43; D8/70  
CPC ..... E04D 13/0765; A01G 20/47; A47L 11/30;  
A47L 11/4066; A47L 11/4002; A47L  
11/4011

See application file for complete search history.

(57) **CLAIM**

The ornamental design for a trailer mounted pressure washer, as shown and described.

**DESCRIPTION**

FIG. 1 is a front, right perspective view of our design for a trailer mounted pressure washer;  
FIG. 2 is a left, rear perspective view thereof;  
FIG. 3 is a front elevation view thereof;  
FIG. 4 is a rear elevation view thereof;  
FIG. 5 is a left side elevation view thereof;  
FIG. 6 is a right side elevation view thereof;  
FIG. 7 is a top plan view thereof; and,  
FIG. 8 is a bottom plan view thereof.  
The broken lines in the figures represent portions of the trailer mounted pressure washer that form no part of the claimed design.

(56) **References Cited**

U.S. PATENT DOCUMENTS

3,263,865 A 8/1966 Kachnik  
D223,039 S \* 2/1972 Widmer ..... D15/7  
D233,545 S \* 11/1974 Johns ..... D32/16  
D253,951 S \* 1/1980 Waters ..... D32/1  
5,002,325 A 3/1991 Fought  
5,299,767 A \* 4/1994 Simpson ..... B05B 15/00  
239/175  
5,704,989 A \* 1/1998 Page ..... A47L 11/34  
134/10

**1 Claim, 8 Drawing Sheets**

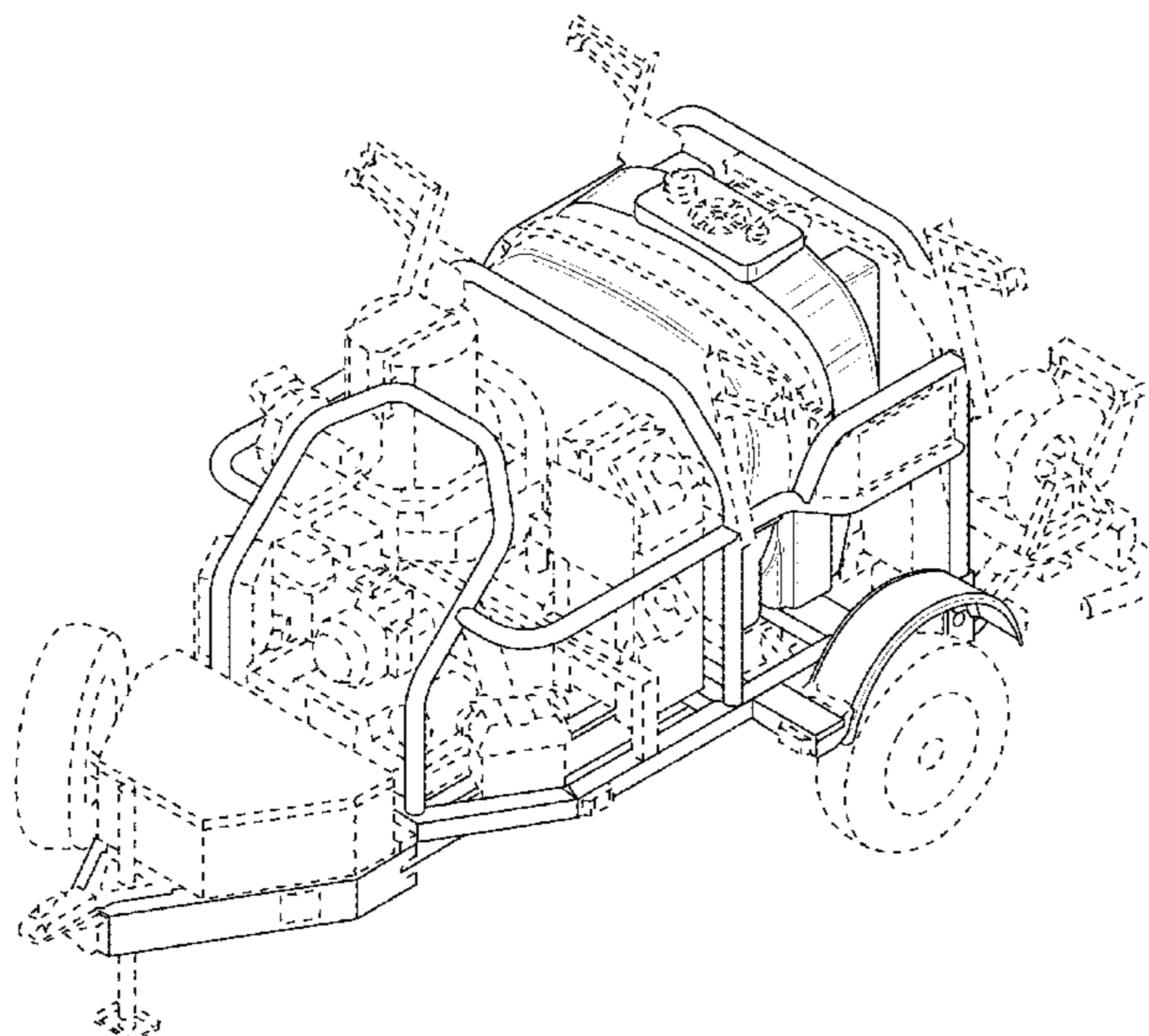

(56)

References Cited

U.S. PATENT DOCUMENTS

7,300,073	B2	11/2007	Bachman	
D570,058	S *	5/2008	Watson	D32/1
D633,263	S *	2/2011	Fay	D32/15
D634,083	S *	3/2011	Fay	D32/15
D639,001	S *	5/2011	Alexander	D32/15
D726,382	S *	4/2015	Taylor	D32/15
D732,764	S *	6/2015	Kennard	D32/15
D824,612	S *	7/2018	Alexander	D32/16
D824,613	S *	7/2018	Alexander	D32/16
D834,269	S *	11/2018	Masters	D32/15
2006/0102745	A1 *	5/2006	Dexter	B05B 9/0855 239/146

FOREIGN PATENT DOCUMENTS

AU	201812033	1/2018
AU	201812037	1/2018
AU	201812028 A	5/2018
CL	2018001038 W	3/2018
CL	2018001040 W	3/2018
CL	2018001041 W	3/2018
CL	2018001044 W	3/2018
CL	2018001032 W	4/2018
CL	2018001033 W	4/2018
CL	2018001034 W	4/2018
CL	2018001035	4/2018
CL	2018001036 W	4/2018
CL	2018001037 W	4/2018
CL	2018001039 W	4/2018
CL	2018001042 W	4/2018
CL	2018001043 W	4/2018

OTHER PUBLICATIONS

NorthStar ProShot Hot Water Commercial Pressure Washer Trailer—4000 PSI, website questions 2018, [https://www.northerntool.com/shop/tools/product\\_200697186\\_200697186](https://www.northerntool.com/shop/tools/product_200697186_200697186), site visited Dec. 4, 2019.\*  
 “Report dated Apr. 20, 2018 for Chilean Patent Application No. 2018-01035, issued by the Chilean PTO.”  
 “Remarks letter by Applicant.”  
 “<http://web.archive.org/web/20150906105925/http://www.northerntool.com/images/downloads/manuals/157595.pdf>.”

“Letter by Goytia & Associates regarding Office Action/Notification of Examination Report for Chilean Patent Application No. 2018-01035, said letter dated Jun. 14, 2019, and interpreting the report dated Apr. 20, 2018 issued by Chilean PTO.”

“<http://web.archive.org/web/20160531105620/http://ultimatewasher.com/trailer-pressure-power-washers.htm>.”

“Trailer Mounted Hot Water/Steam Pressure Washer 3000 PSI/4.0GPM”, (item No. 157561 <https://www.northerntool.com/images/downloads/manuals/157561.pdf>.

<https://amazon.com/26x102-Gooseneck-Trailer-zplsndzsd-26XT/dp/B01E9CXTFWC> (Nov. 28, 2016).

[https://amazon.com/dp/B01E9XGG9M/ref=psdc\\_5743826011\\_13\\_B01EQK3L21](https://amazon.com/dp/B01E9XGG9M/ref=psdc_5743826011_13_B01EQK3L21) (Nov. 28, 2016).

[https://amazon.com/dp/B01EQK3L2/ref=psdc\\_5743826011\\_11\\_B01E9XTFWC](https://amazon.com/dp/B01EQK3L2/ref=psdc_5743826011_11_B01E9XTFWC) (Apr. 24, 2016).

[https://amazon.com/dp/B01EQK3L2/ref=psdc\\_5743826011\\_13B01EQKJOB0](https://amazon.com/dp/B01EQK3L2/ref=psdc_5743826011_13B01EQKJOB0) (Apr. 24, 2016).

<https://northerntool.com/images/downloads/manuals/157565.pdf> (it is believed the link was published by Applicant on or around Nov. 29, 2018).

<https://northerntool.com/images/downloads/manuals/157567.pdf> (it is believed the link was published by Applicant on or around Jan. 29, 2019).

<https://northerntool.com/images/downloads/manuals/157569.pdf>.

<http://web.archive.org/web/20161025170211/http://landamidwest.com/products/mobile-wash-trailers/tr-60000-series>.

<http://web.archive.org/web/20161105004125/http://powerlineindustriesreviews.com/index.php/trailer-power-washers>.

<http://web.archive.org/web/201703230502/https://www.pressurewashersdirect.com/Cam-Spray-CBG5055HT-Pressure-Washer/p10381.html>.

<http://web.archive.org/web/20170903074431/https://www.ramteg.com/en/custom-trailers-photos>.

<http://web.archive.org/web/20171010041329/http://wet-inc.com/oil-field-cleaning/>.

<https://www.youtube.com/watch?v=HPSOVOrCVq0>.

Letter by Goytia & Associates regarding second Office Action/Notification of Examination Report for Chilean Patent Application No. 2018-01035, said letter dated Dec. 27, 2019, and interpreting the report issued by Chilean PTO.

Owner’s Manual M157563D.3-Trailer Mounted Hot Water/Steam Pressure Water-Item No. 157563, <https://northerntool.com/images/downloads/manuals/157563.pdf>.

\* cited by examiner



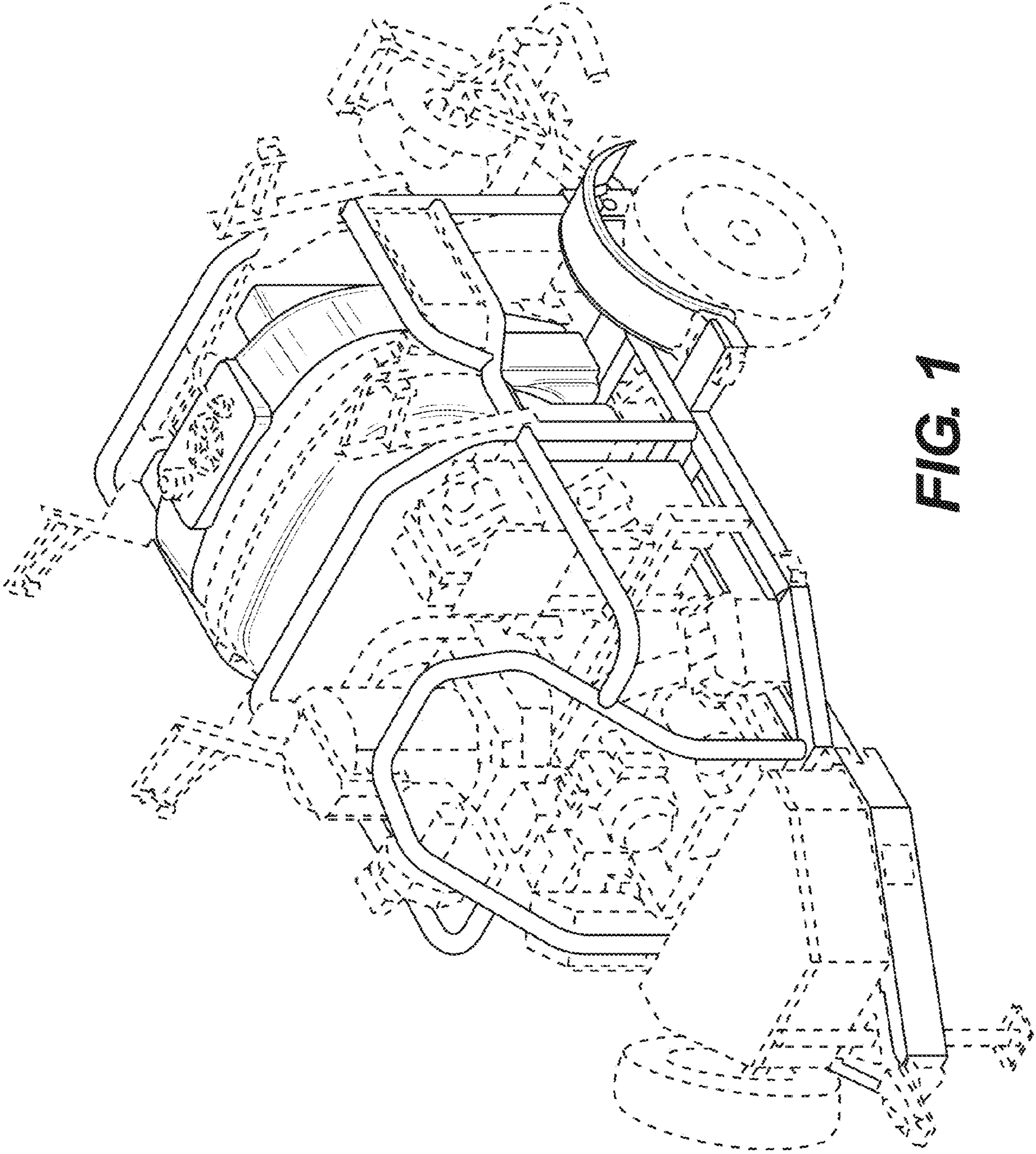
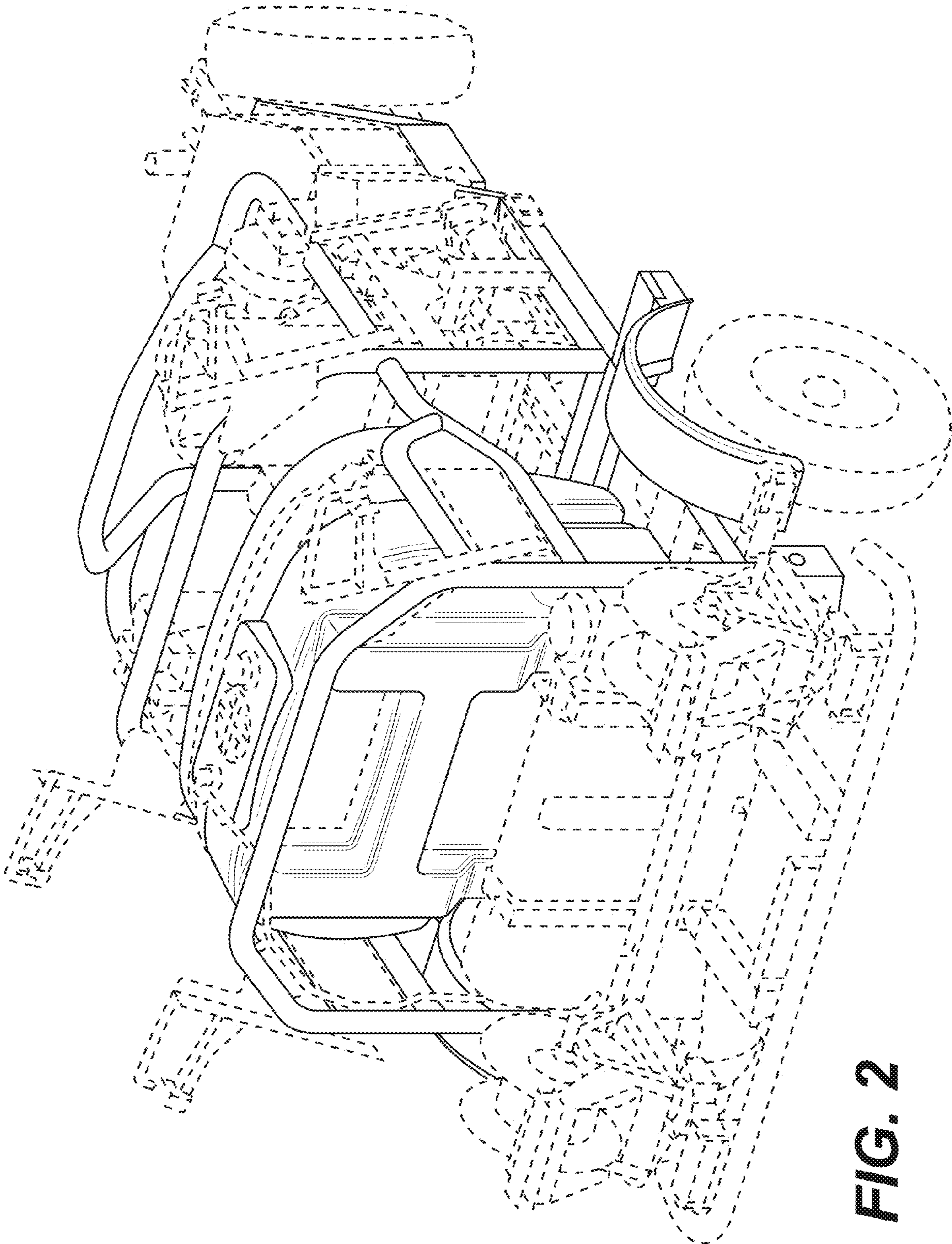
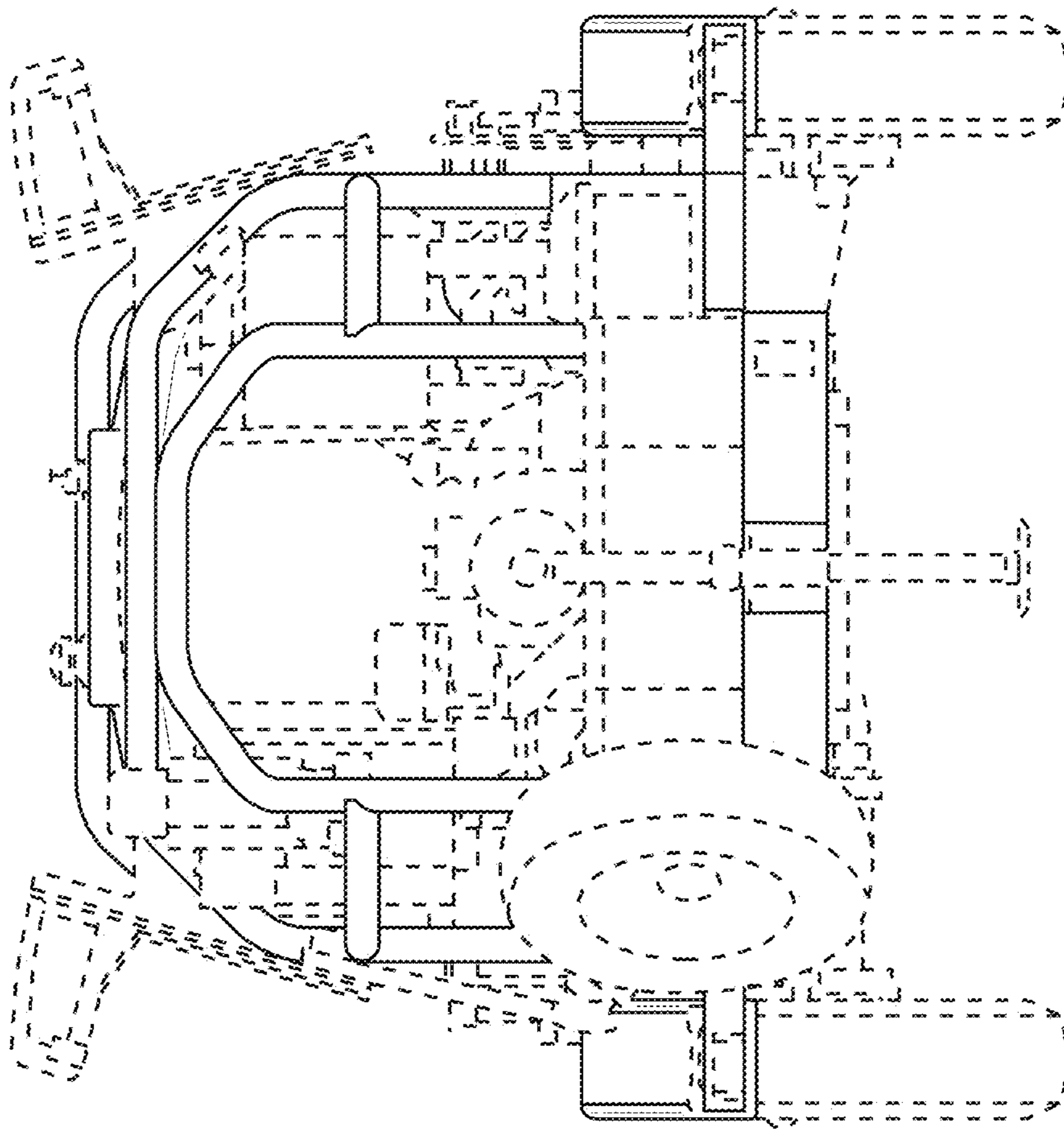

FIG. 1

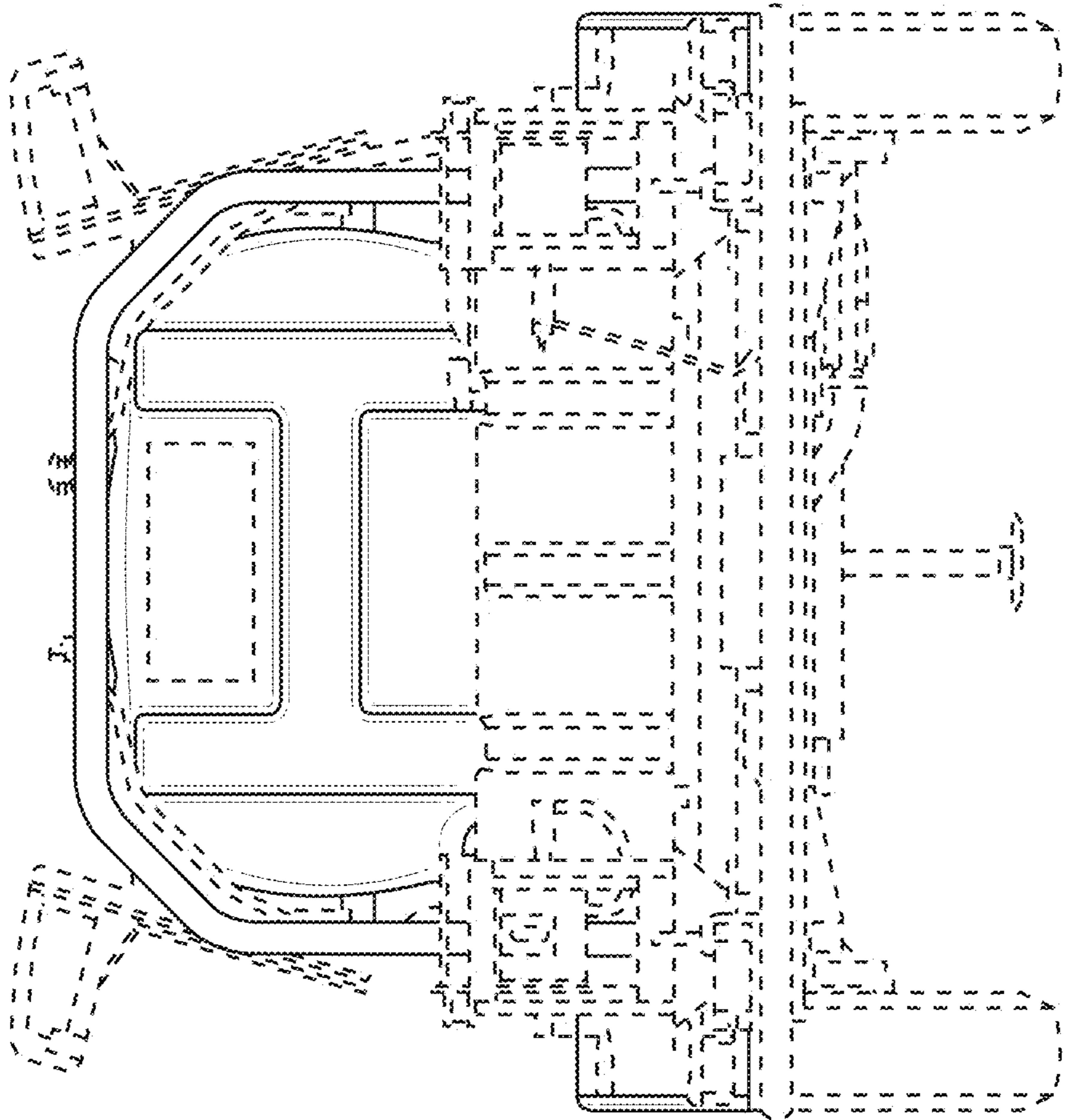

**FIG. 2**

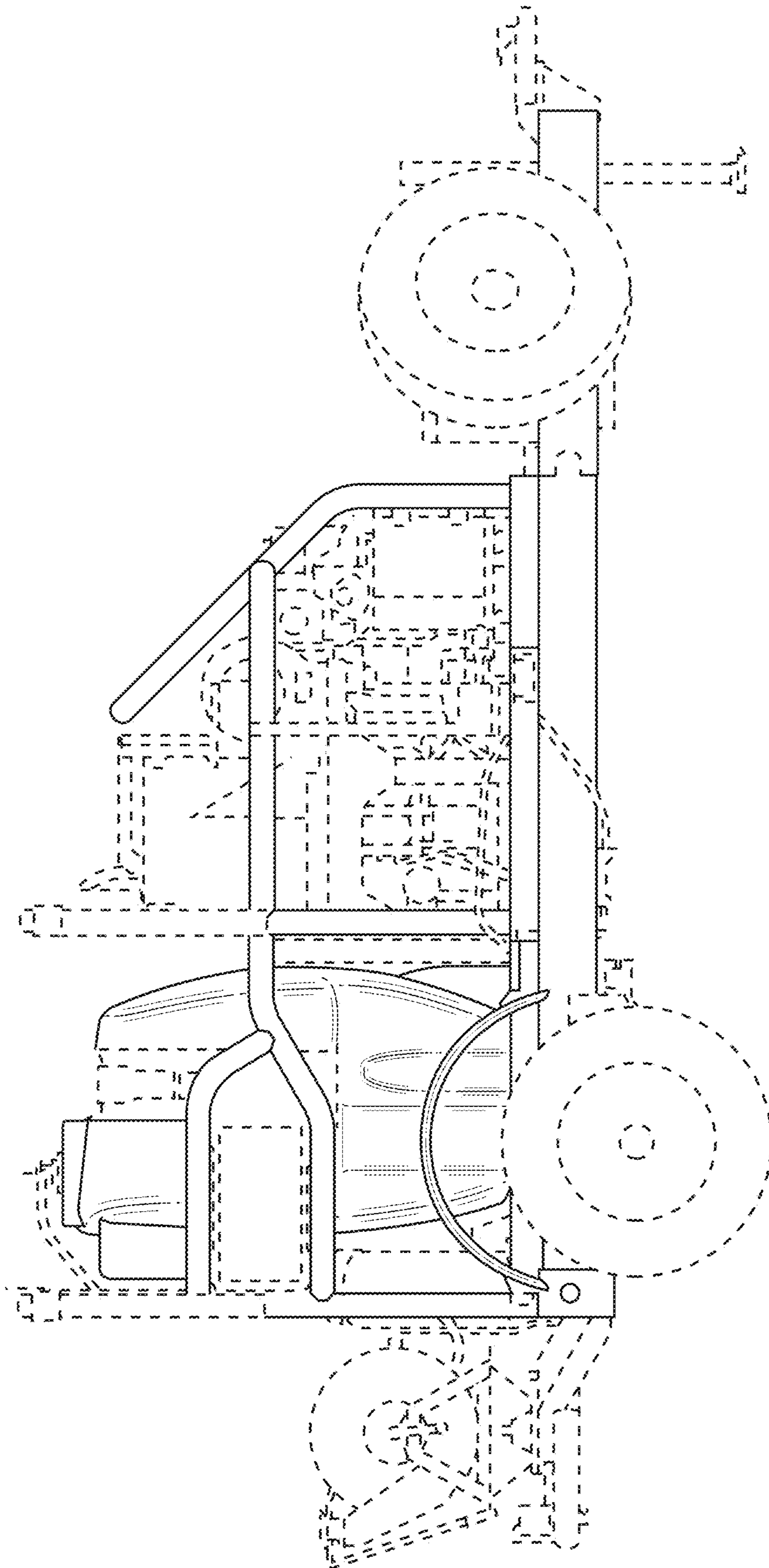

**FIG. 3**

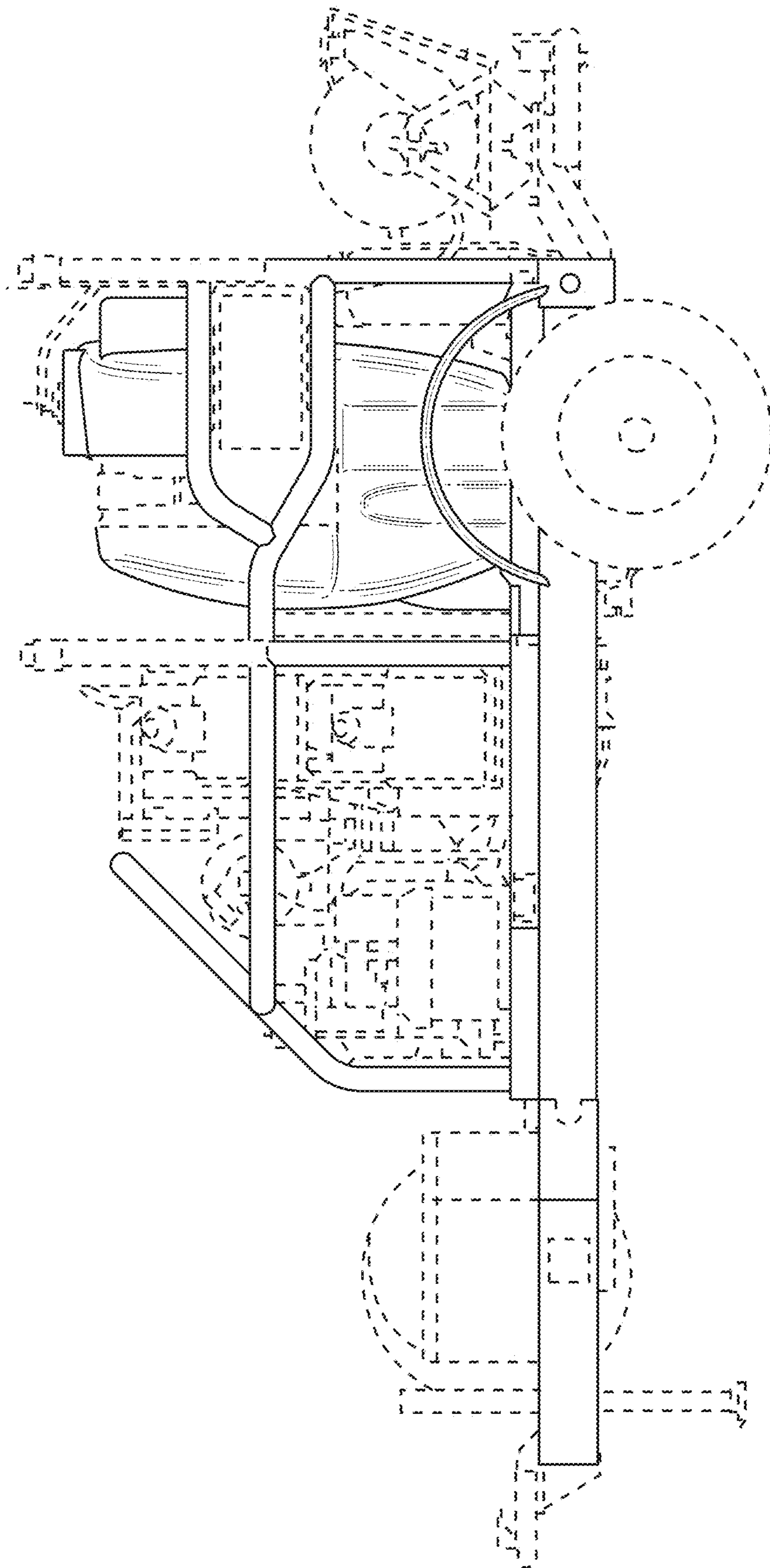



**FIG. 4**

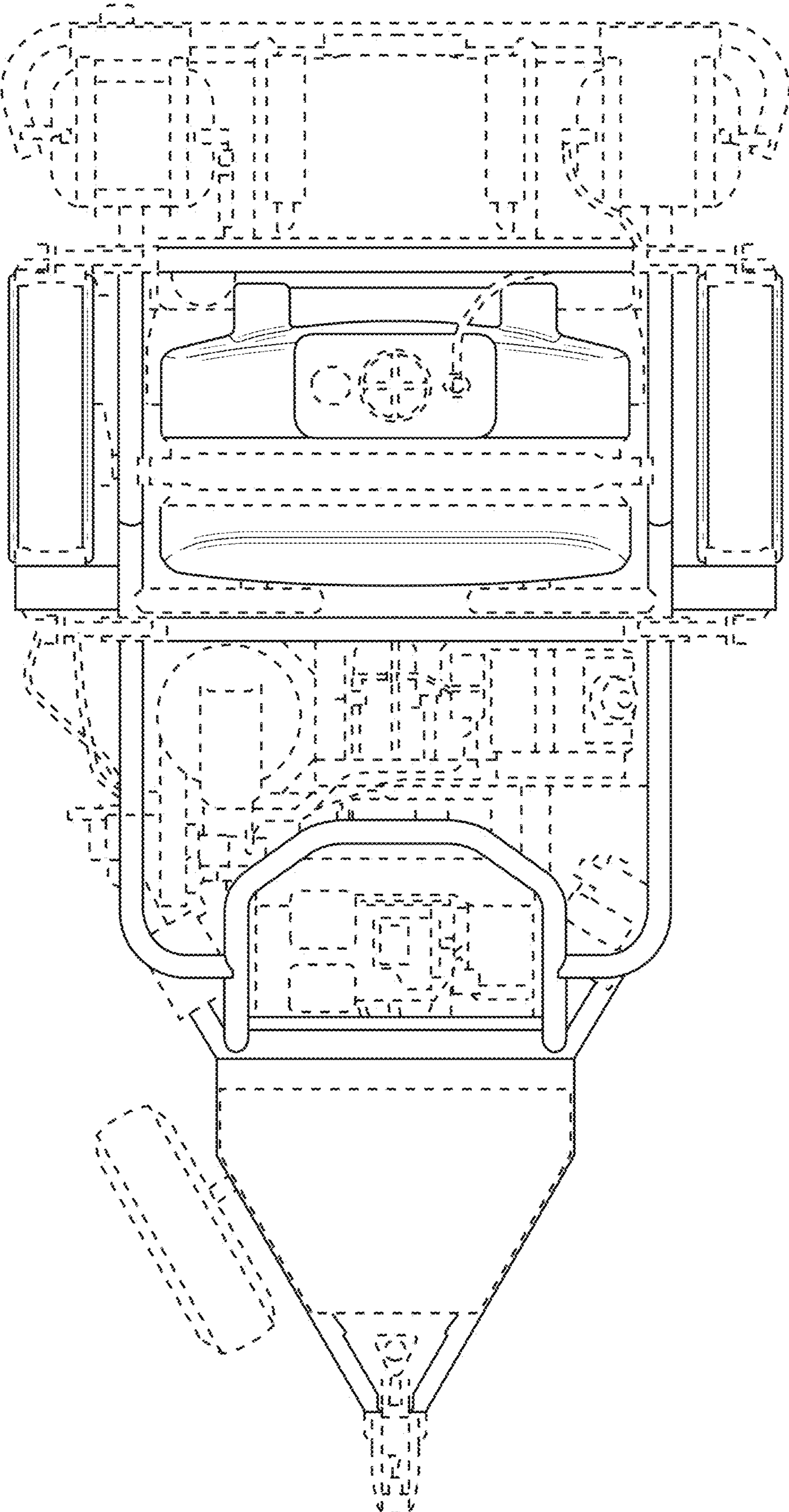

**FIG. 5**



**FIG. 6**





**FIG. 7**

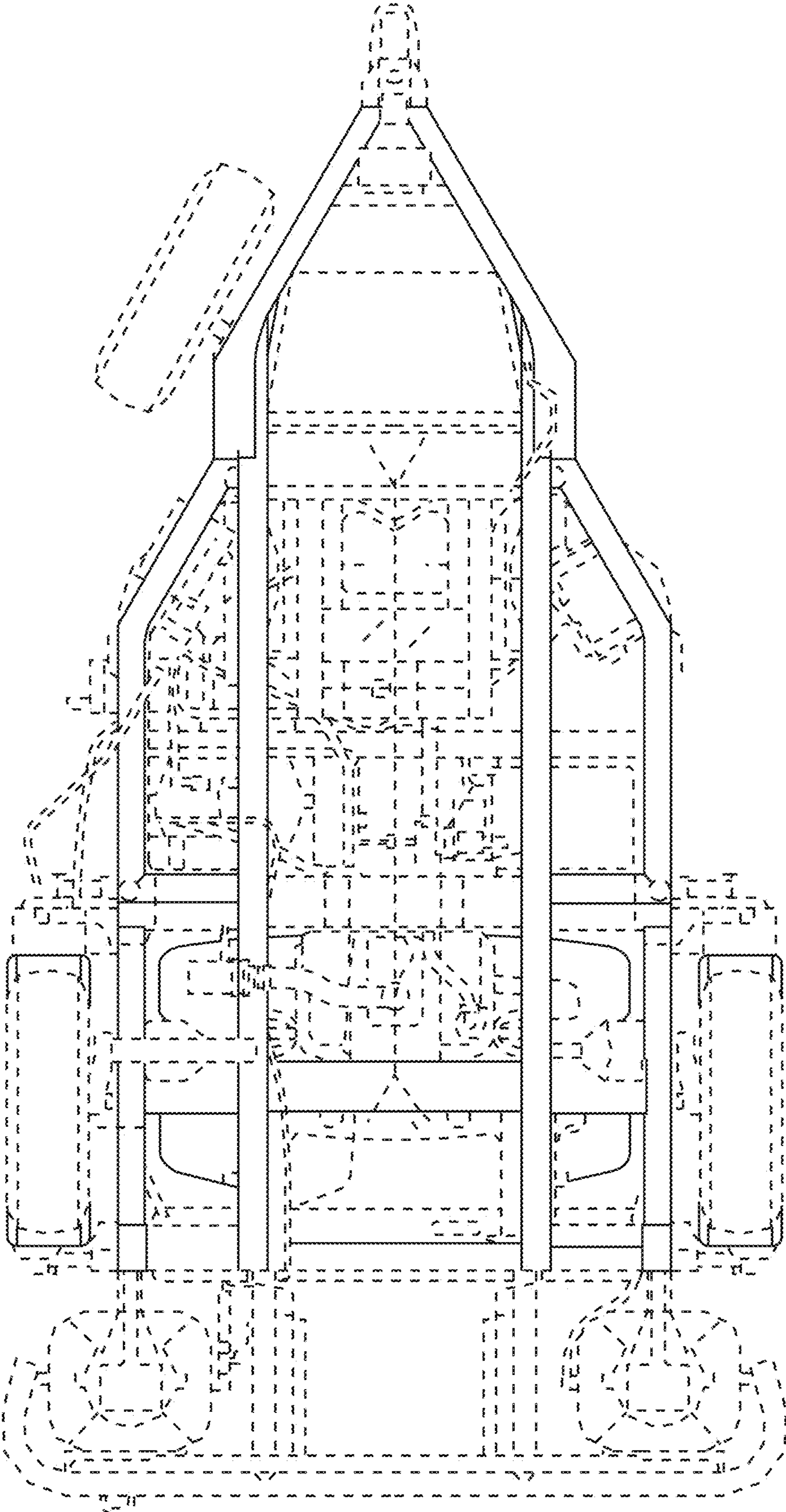

FIG. 8