



US00D911609S

(12) **United States Design Patent** (10) **Patent No.:** **US D911,609 S**
Li (45) **Date of Patent:** **** Feb. 23, 2021**

(54) **LINT REMOVER**
(71) Applicant: **Daxin Li**, Xiaogan (CN)
(72) Inventor: **Daxin Li**, Xiaogan (CN)
(**) Term: **15 Years**
(21) Appl. No.: **29/715,810**
(22) Filed: **Dec. 4, 2019**
(51) **LOC (13) Cl.** **28-03**
(52) **U.S. Cl.**
USPC **D28/50**
(58) **Field of Classification Search**
USPC D28/49–54
CPC . B26B 19/14; B26B 19/48; B26B 19/00–107;
B26B 19/12–265; B26B 19/38; B26B
19/3853–3866; B26B 19/3873–388; B26B
19/46
See application file for complete search history.

D495,831 S * 9/2004 Hsu D28/50
D500,168 S * 12/2004 Ho D28/44
D513,814 S * 1/2006 Chen D28/50
D546,001 S * 7/2007 McLachlan D28/50
D620,643 S * 7/2010 Teteak D28/50
D671,267 S * 11/2012 Hsu D28/50
D678,611 S * 3/2013 Hsu D28/50
D808,077 S * 1/2018 Boulanger D28/50
D824,104 S * 7/2018 Boulanger D28/51
D828,626 S * 9/2018 Hsu D28/50
D841,243 S * 2/2019 Hsu D28/50
D841,244 S * 2/2019 Hsu D28/50
D841,245 S * 2/2019 Chen D28/50

(Continued)

OTHER PUBLICATIONS

Meomy Fabric Shaver, www.amazon.com, reviewed as early as Feb. 2020, 1 page (Year: 2020).*

Primary Examiner — Jennifer Rivard
(74) *Attorney, Agent, or Firm* — Law Offices of Steven W. Weinrieb

(56) **References Cited**
U.S. PATENT DOCUMENTS
D220,374 S * 3/1971 Ono D28/50
D220,607 S * 4/1971 Ono D28/50
D298,361 S * 11/1988 Thaler D28/50
4,788,769 A * 12/1988 Maruyama A47L 25/08
15/344
4,839,964 A * 6/1989 Uchiyama B26B 19/141
30/43.5
4,899,442 A * 2/1990 Horii A47L 25/08
30/133
D307,957 S * 5/1990 Mockovak D28/50
D310,890 S * 9/1990 Ho D28/50
D314,642 S * 2/1991 Ying D28/50
D319,564 S * 9/1991 Okayasu D8/61
D321,115 S * 10/1991 Henry D8/61
D455,228 S * 4/2002 Hsu D28/50
D459,028 S * 6/2002 Hsu D28/50
D472,024 S * 3/2003 Caldwell B26B 19/14
D32/32
D476,444 S * 6/2003 Hara D28/50

(57) **CLAIM**
The ornamental design for a lint remover, as shown and described.

DESCRIPTION

FIG. 1 is a front, right side, top perspective view of a lint remover showing my new design;
FIG. 2 is a rear, right side, top perspective view thereof;
FIG. 3 is a front elevational view thereof;
FIG. 4 is a rear elevational view thereof;
FIG. 5 is a left side elevational view thereof;
FIG. 6 is a right side elevational view thereof;
FIG. 7 is a top plan view thereof; and,
FIG. 8 is a bottom plan view thereof.
The broken lines depict portions of the lint remover that form no part of the claimed design.

1 Claim, 8 Drawing Sheets

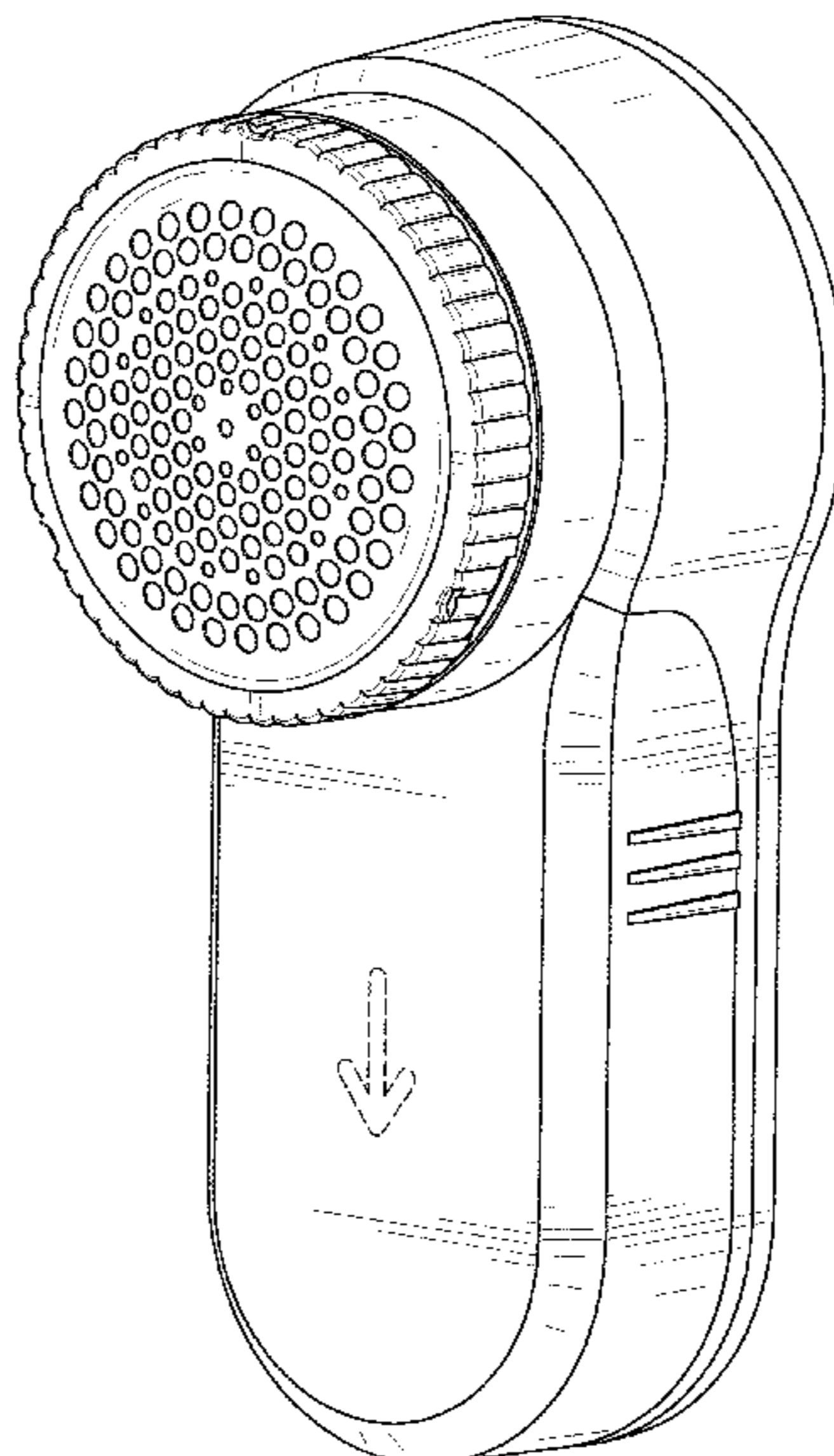

(56)

References Cited

U.S. PATENT DOCUMENTS

D845,544 S * 4/2019 Hsu D28/50
D866,071 S * 11/2019 Luo D28/50
2011/0308035 A1* 12/2011 Casper A01K 13/001
15/344
2020/0282580 A1* 9/2020 McKinnis B26B 19/384

* cited by examiner

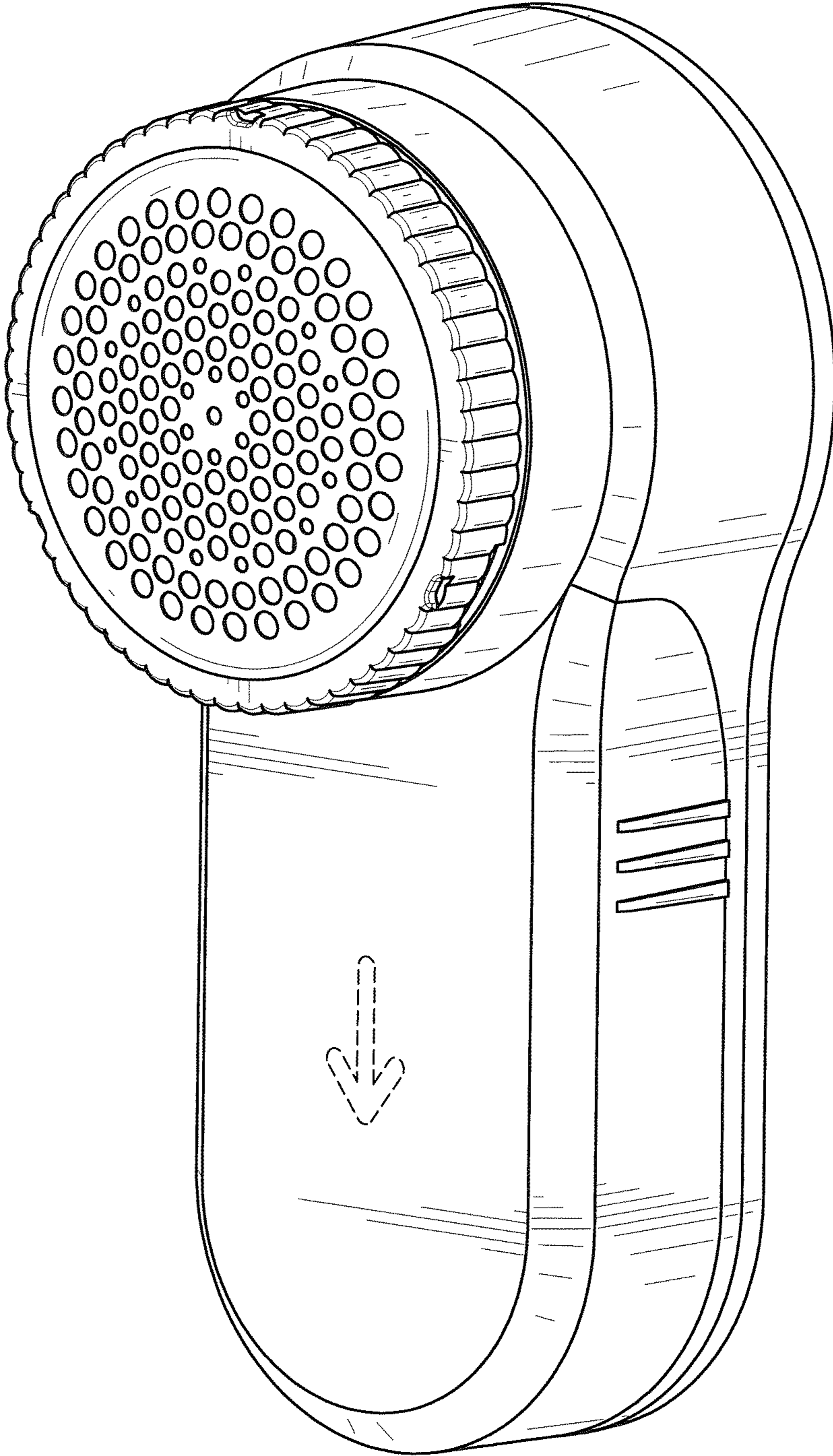

FIG.1

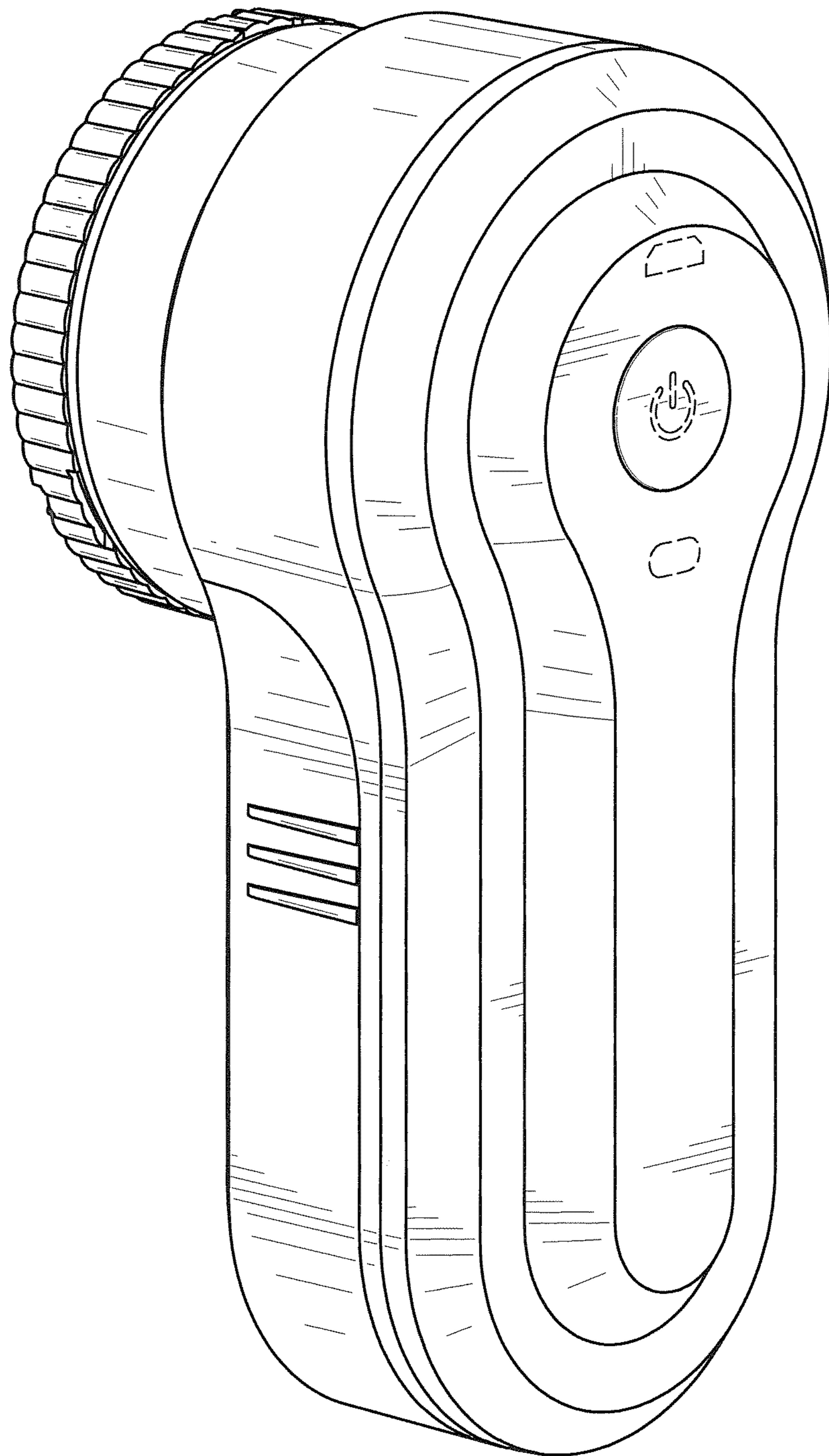

FIG.2

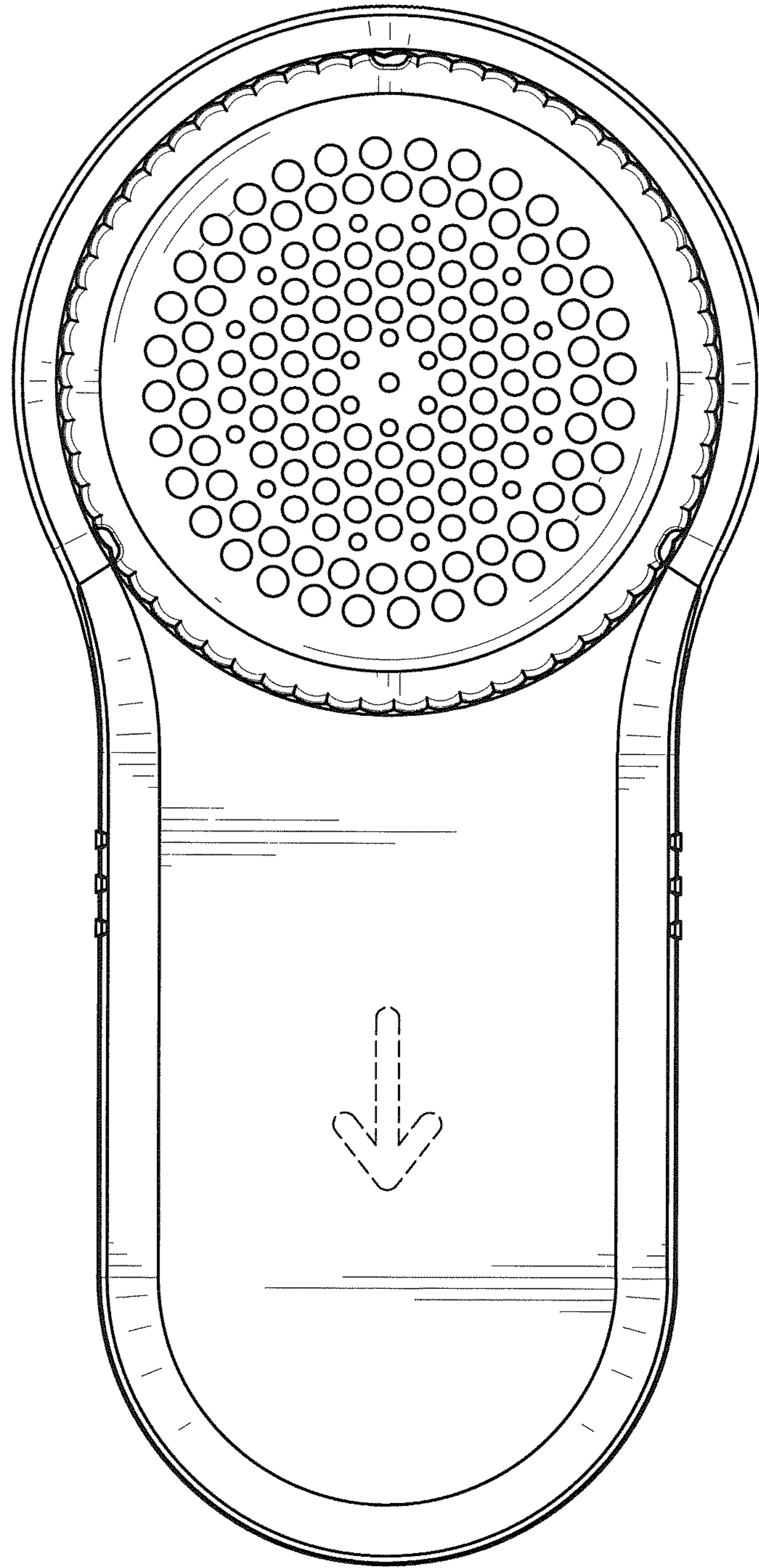

FIG. 3

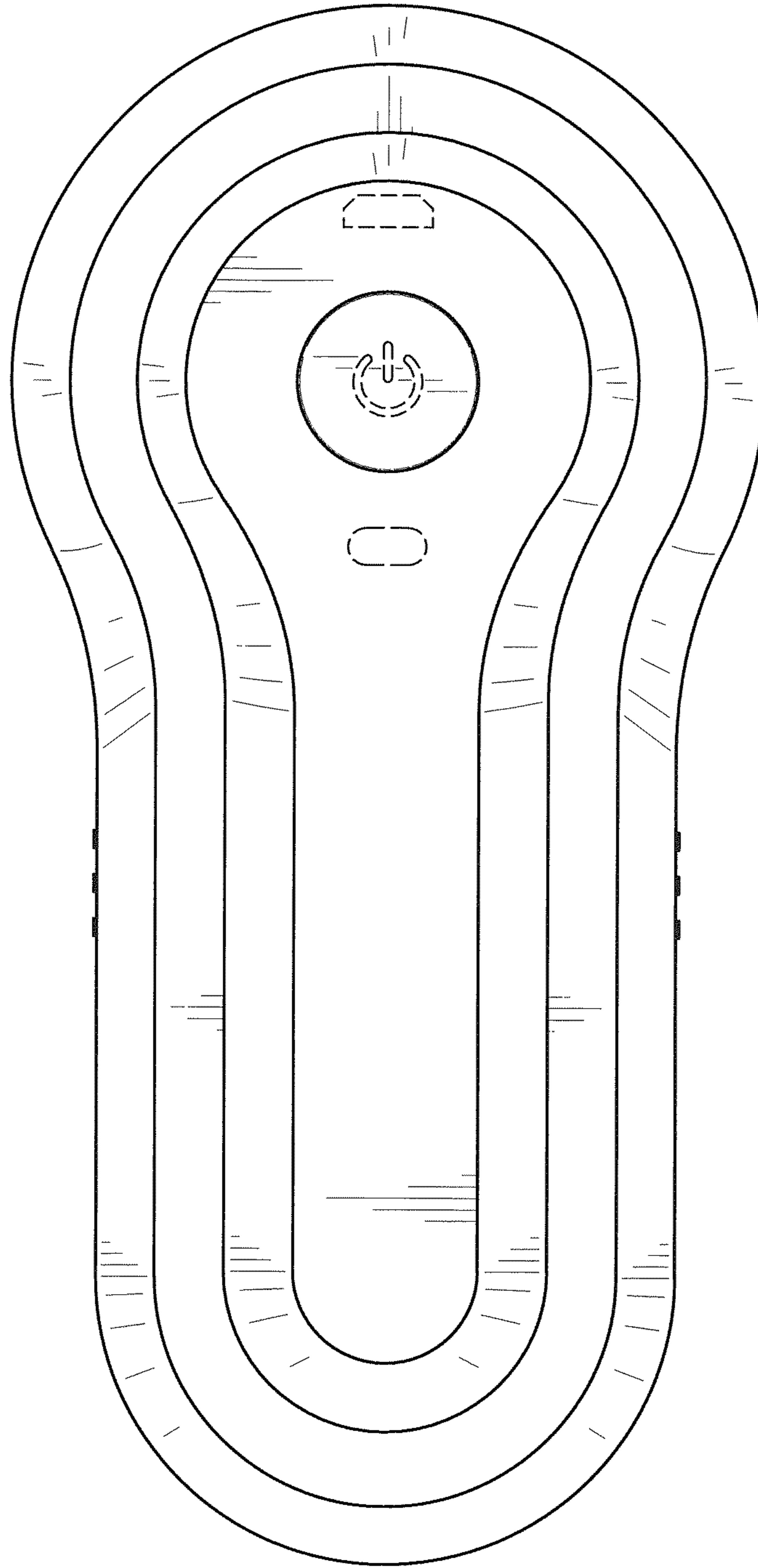

FIG. 4

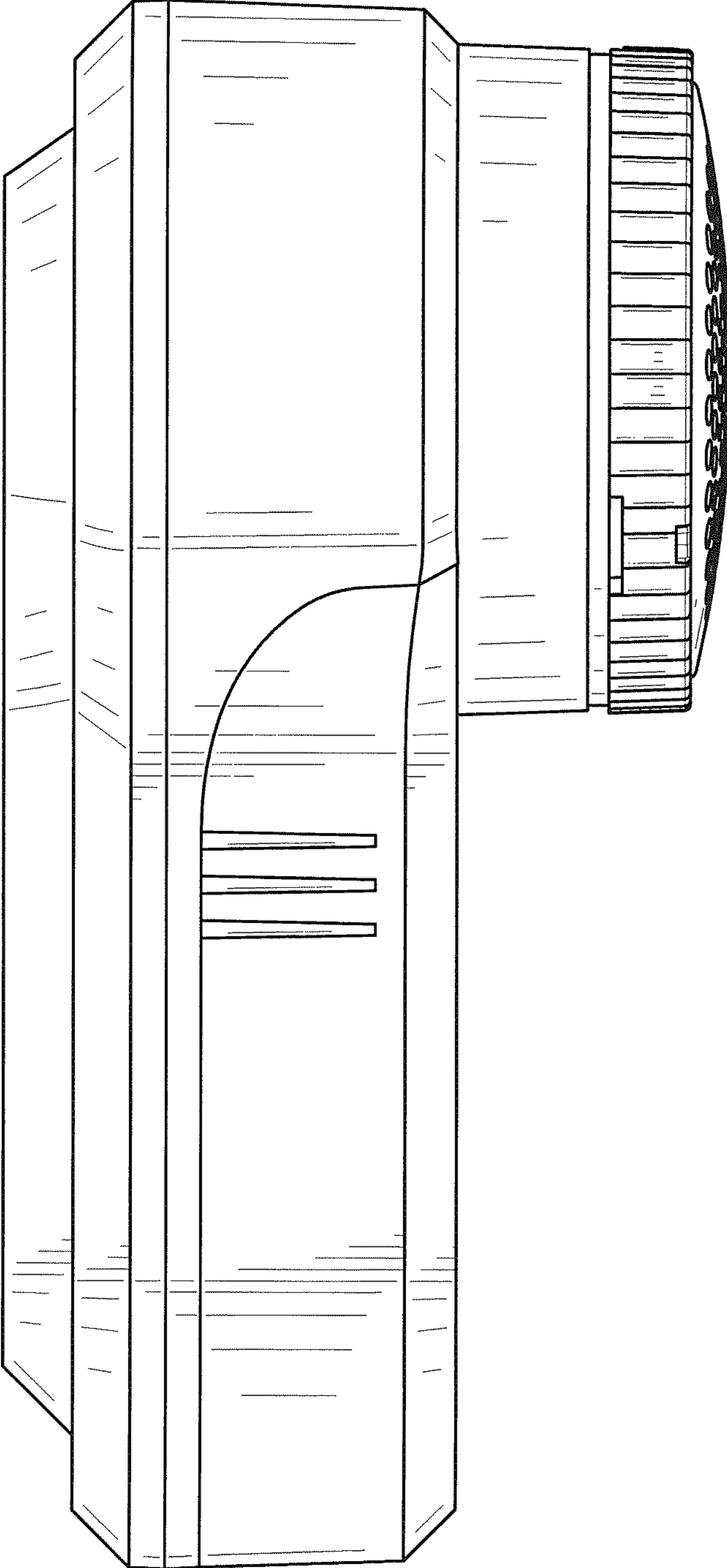

FIG.5

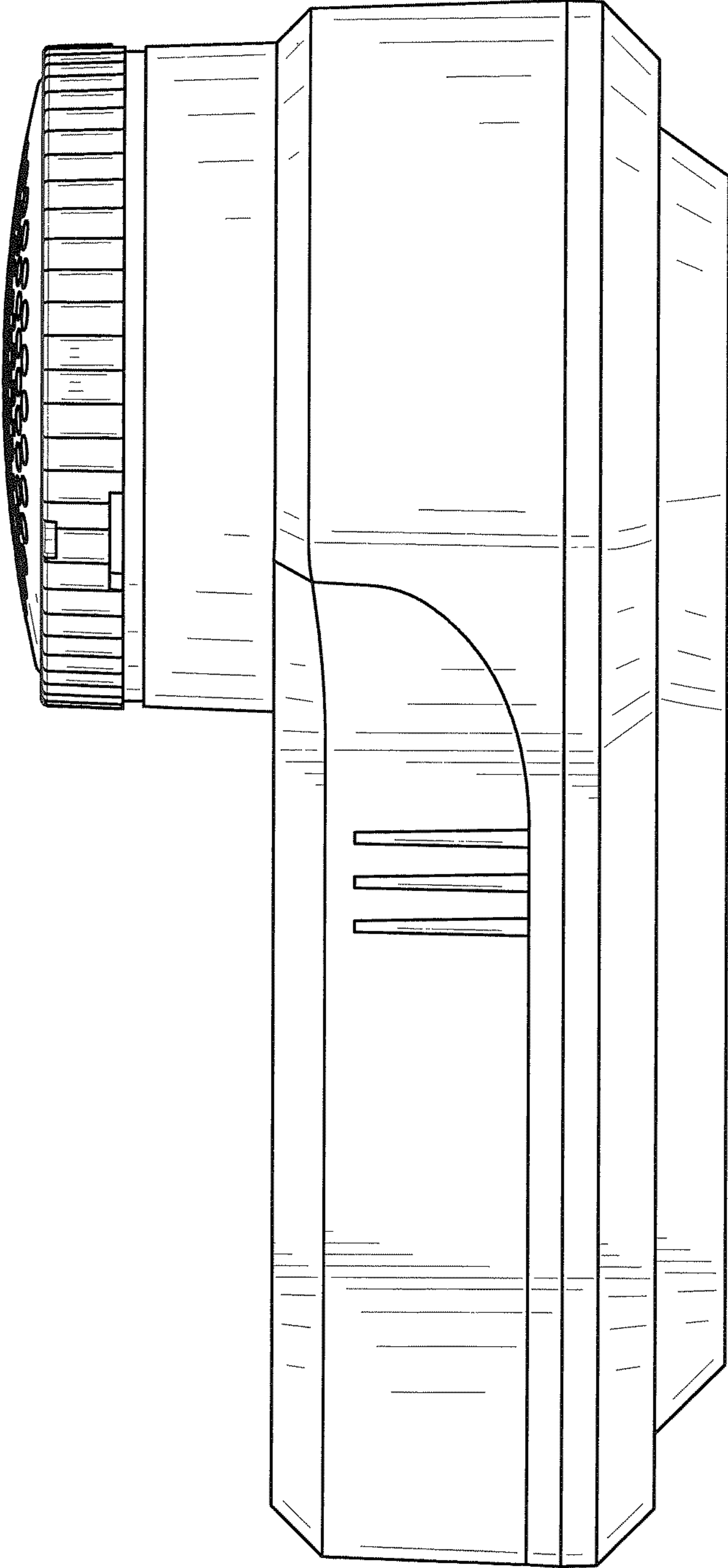

FIG.6

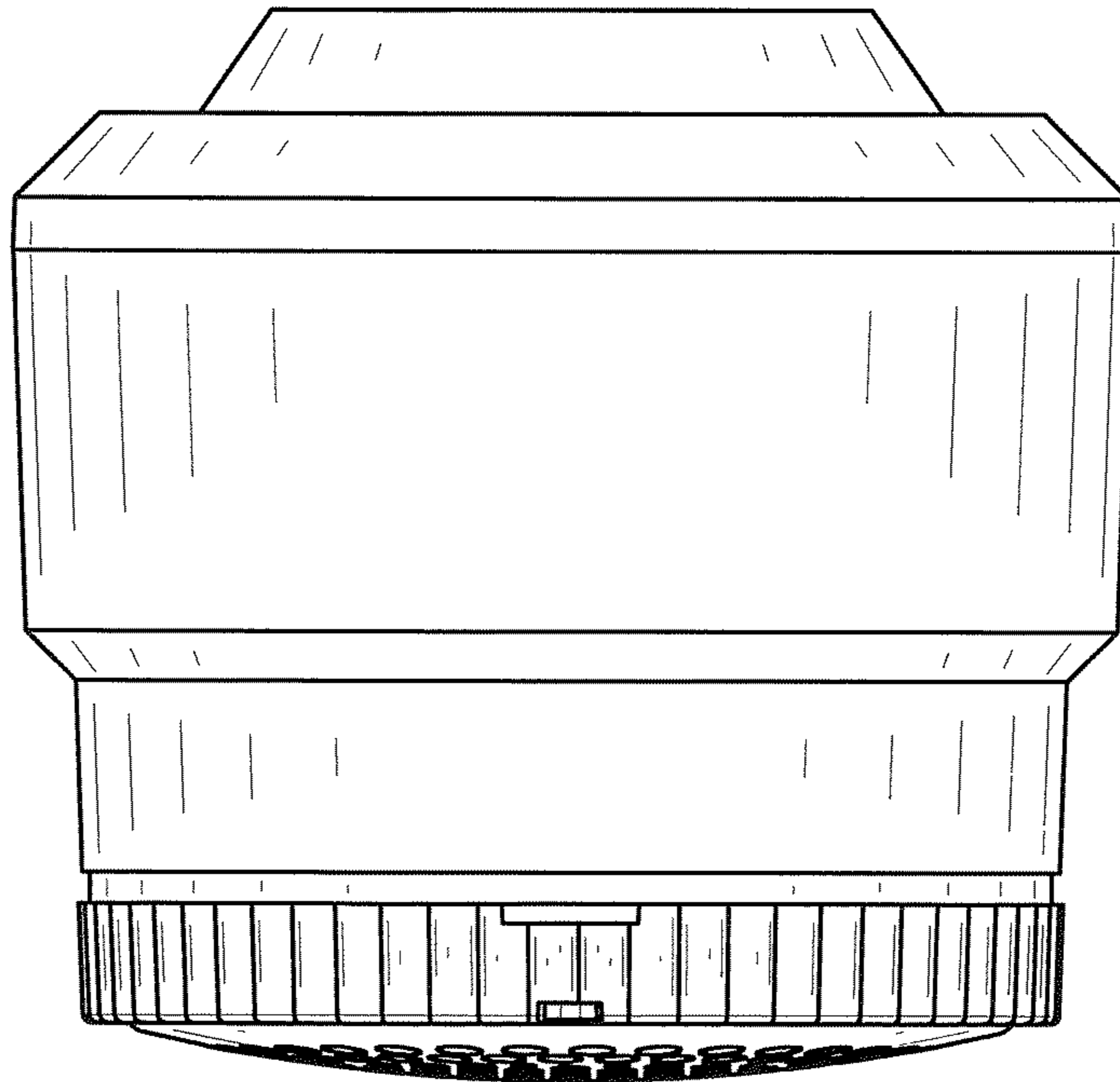

FIG.7

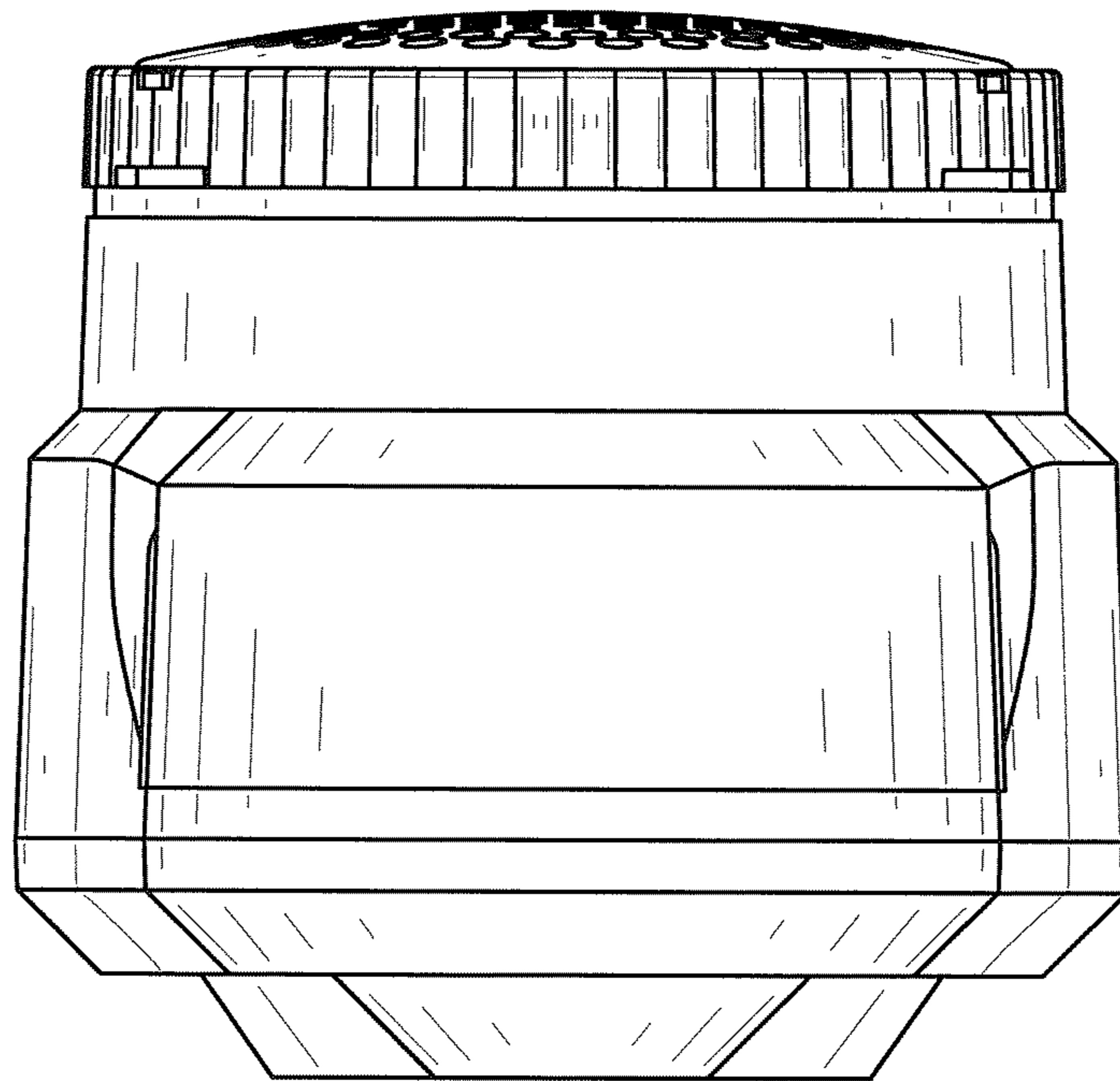

FIG.8