



US00D911540S

(12) **United States Design Patent** (10) **Patent No.:** **US D911,540 S**
Li (45) **Date of Patent:** **** Feb. 23, 2021**

(54) **PORTABLE THERAPY LAMP**

(71) Applicant: **Yingfa Li**, Nanxiong (CN)

(72) Inventor: **Yingfa Li**, Nanxiong (CN)

(**) Term: **15 Years**

(21) Appl. No.: **29/698,445**

(22) Filed: **Jul. 17, 2019**

(51) **LOC (13) Cl.** **28-03**

(52) **U.S. Cl.**
USPC **D24/210**

(58) **Field of Classification Search**
USPC D24/107, 186, 200, 209, 210, 231;
D26/37-39

CPC A61N 5/062; A61N 5/0614; A61N 5/0616;
A61N 5/0617; A61N 5/0618; A61N
5/0624; A61N 5/0627; A61N 5/0625;
A61N 2005/0643; A61N 2005/0644;
A61N 2005/0645; A61N 2005/0647;
A61N 2005/0651; A61N 2005/0652;
A61N 2005/0654; A61N 2005/0662;
A61B 2018/00452; A61B 2018/1807

See application file for complete search history.

(56) **References Cited**

U.S. PATENT DOCUMENTS

D510,627 S * 10/2005 Lomborg D24/209
D545,973 S * 7/2007 Powell D24/209

D597,214 S * 7/2009 Savage D24/209
D599,485 S * 9/2009 Burrows D24/209
D641,490 S * 7/2011 Fernie D24/210
D647,626 S * 10/2011 Nitsch D24/209
D875,265 S * 2/2020 Li D24/210
D879,984 S * 3/2020 Hu D24/209
2017/0212292 A1 * 7/2017 Brada G02B 6/0031

* cited by examiner

Primary Examiner — Anhdao Doan

(74) *Attorney, Agent, or Firm* — Rumit Ranjit Kanakia

(57) **CLAIM**

I claim the ornamental design for a portable therapy lamp, as shown and described.

DESCRIPTION

FIG. 1 is a perspective view of a desktop therapy lamp with a stand in an extended position;
FIG. 2 is a front view thereof;
FIG. 3 is a rear view thereof with the stand in a folded position;
FIG. 4 is a right-side view thereof;
FIG. 5 is a left-side view thereof;
FIG. 6 is a top view thereof; and,
FIG. 7 is a bottom view thereof.
The broken lines depict environmental subject matter and form no part of the claimed design.

1 Claim, 6 Drawing Sheets

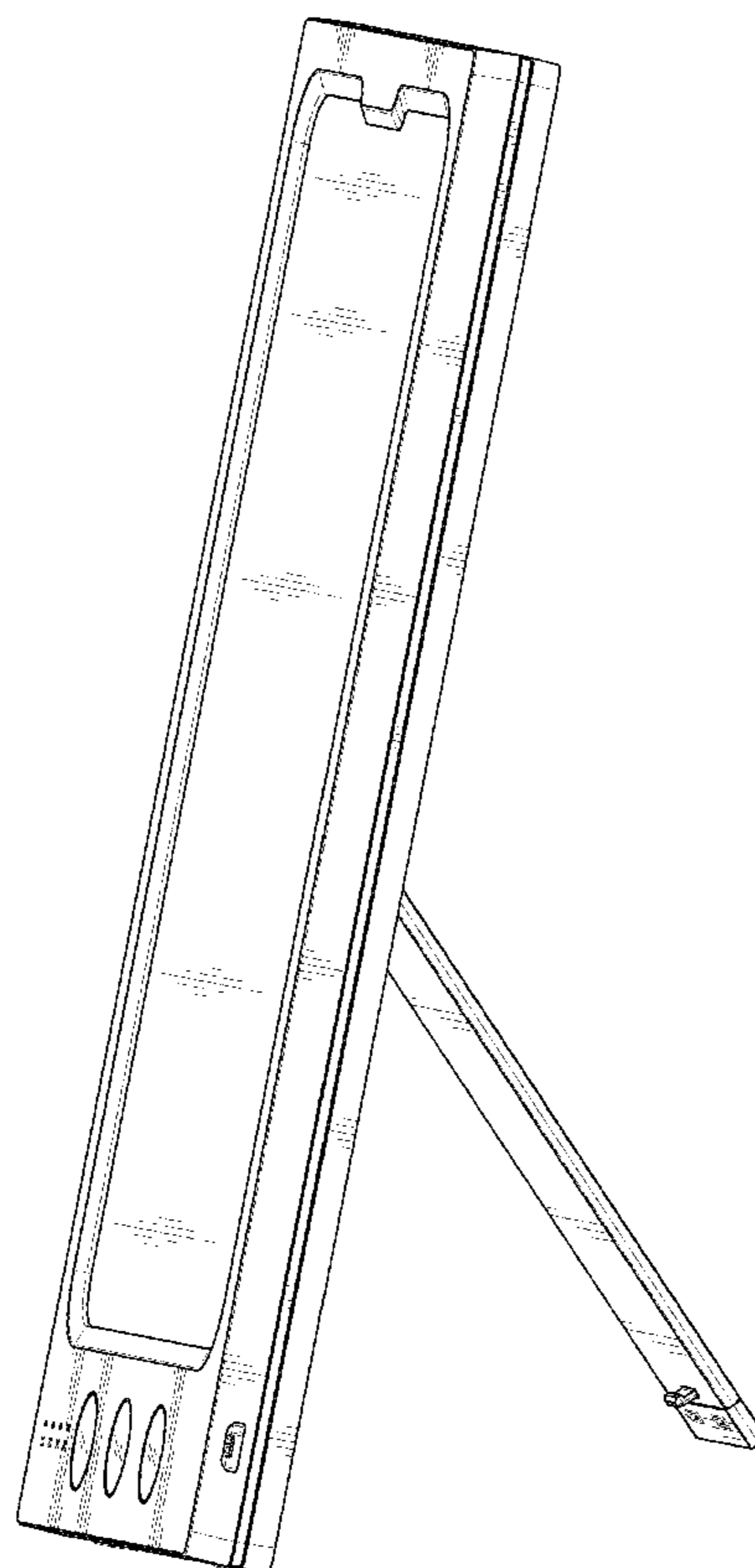

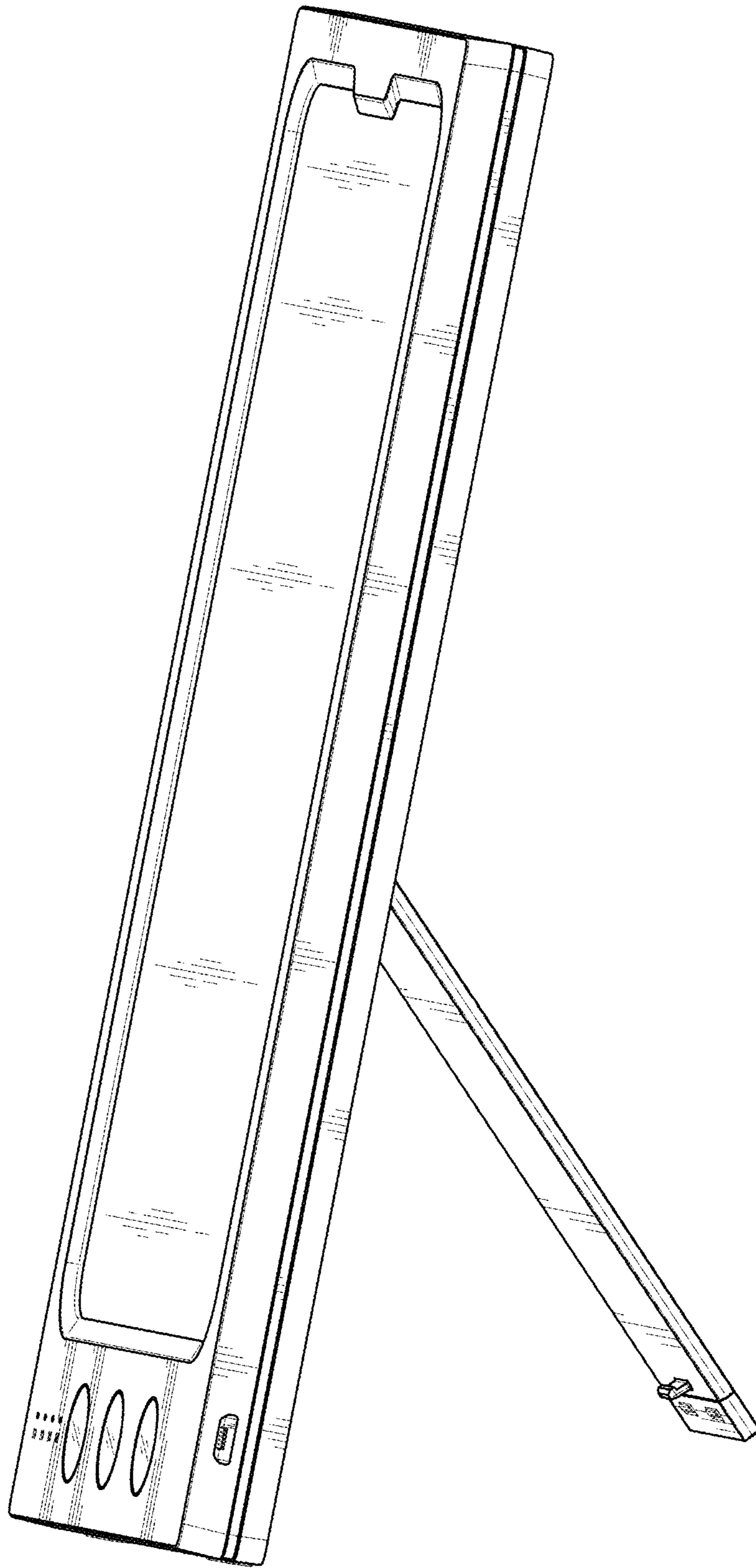

FIG. 1

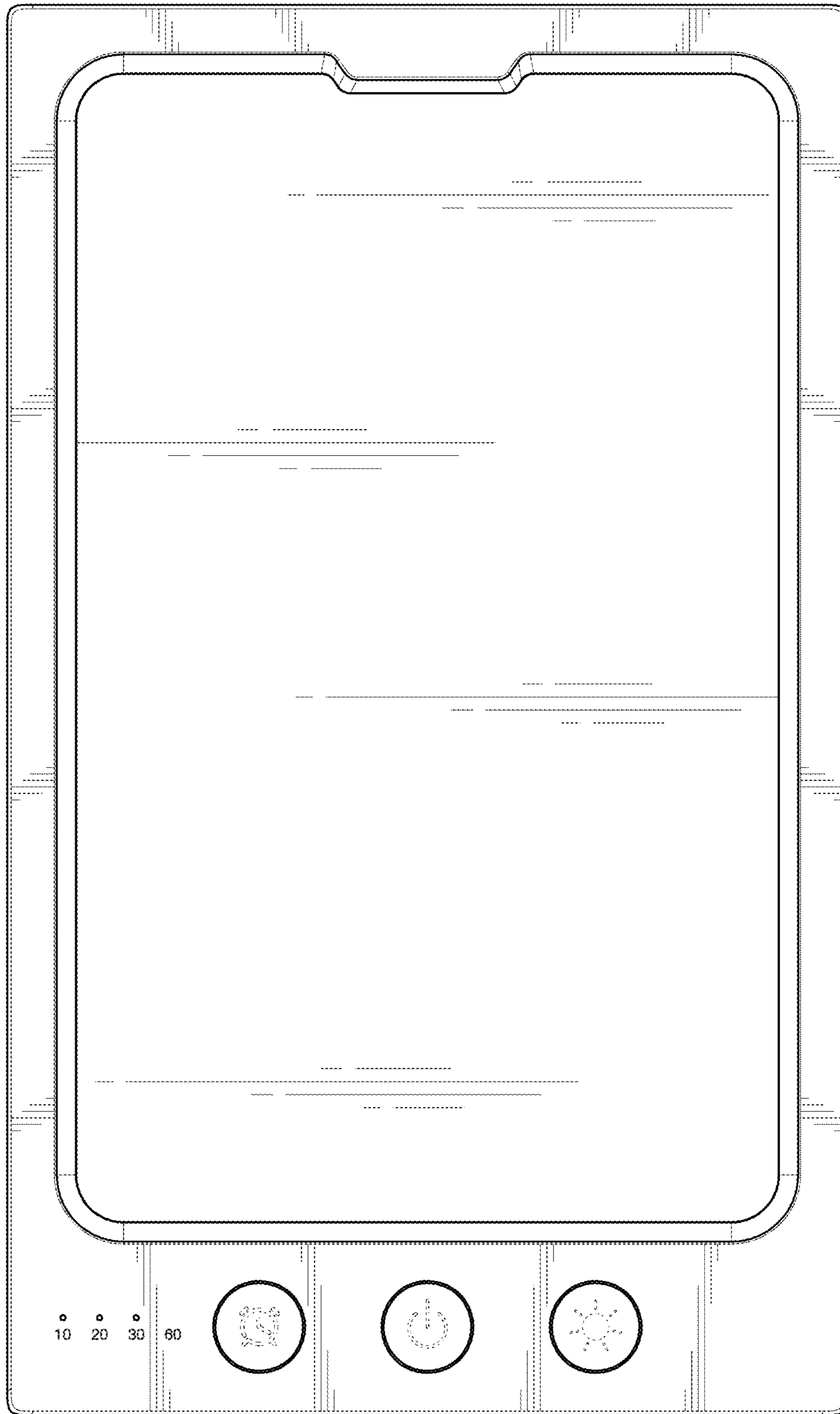

FIG. 2

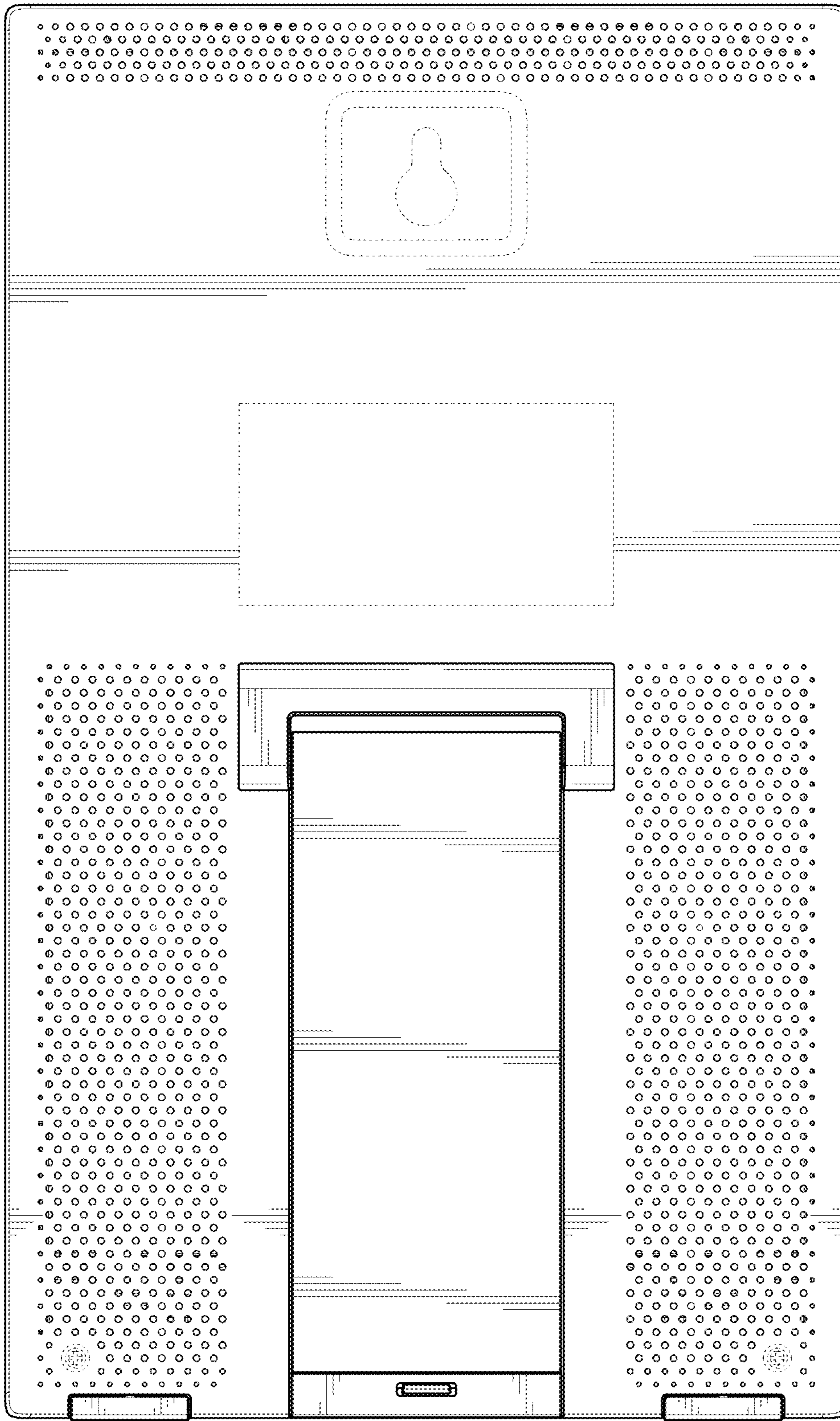

FIG. 3

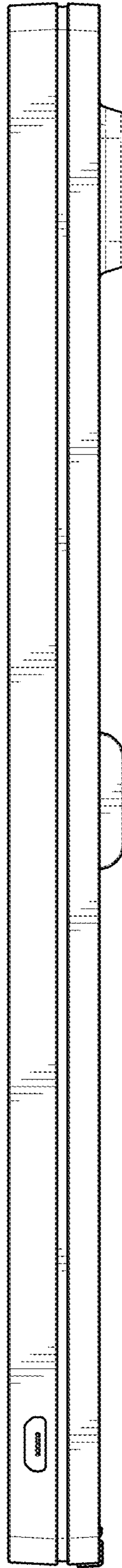

FIG. 4

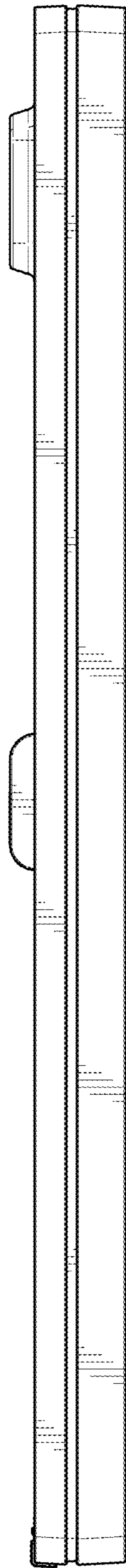

FIG. 5

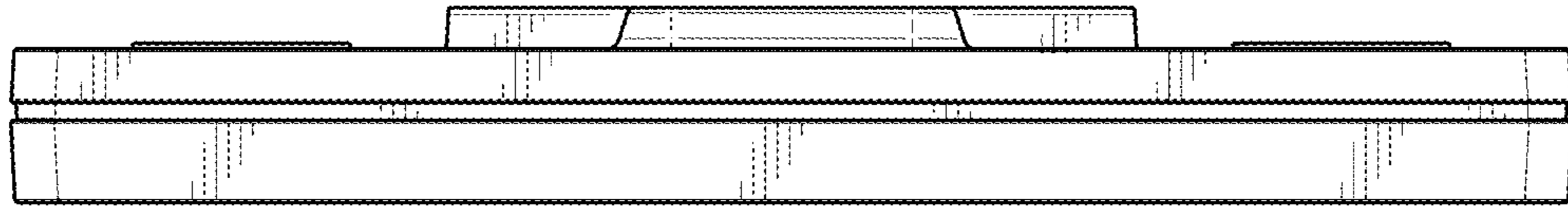

FIG. 6

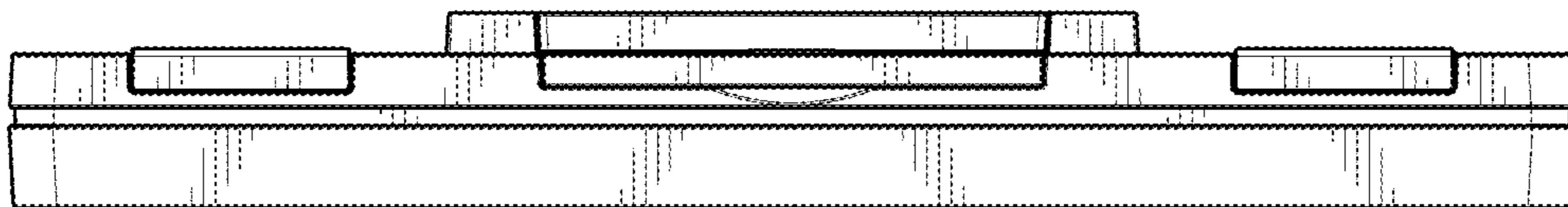

FIG. 7