



US00D911536S

(12) **United States Design Patent** (10) **Patent No.:** **US D911,536 S**
Lunter et al. (45) **Date of Patent:** **** Feb. 23, 2021**

- (54) **APPARATUS FOR DRY HYDRO-THERAPY BODY MASSAGE**
- (71) Applicant: **JTL Enterprises, Inc.**, Clearwater, FL (US)
- (72) Inventors: **Paul Lunter**, Palm Harbor, FL (US); **Timothy Elliott**, Pinellas Park, FL (US)
- (73) Assignee: **JTL Enterprises, inc.**, Clearwater, FL (US)
- (**) Term: **15 Years**
- (21) Appl. No.: **29/682,034**
- (22) Filed: **Mar. 1, 2019**
- (51) **LOC (13) Cl.** **28-03**
- (52) **U.S. Cl.**
USPC **D24/201**
- (58) **Field of Classification Search**
USPC D24/201–205, 213, 183, 184;
D23/276–278, 280.1–280.3; D6/335,
D6/361, 371–373, 382
CPC A61H 2203/0431; A61H 2203/0437; A61H
2201/1633; A61H 2201/1623; A61H
2201/1628; A61H 2201/0149; A47C 1/02;
A47C 1/12; A47C 4/52; A47C 17/02
See application file for complete search history.

- (56) **References Cited**
U.S. PATENT DOCUMENTS
- 5,827,206 A * 10/1998 Lunter A61H 9/0021
601/148
- D472,720 S * 4/2003 Cheng D6/335

D531,318 S *	10/2006	Morral Gispert	D24/201
7,120,353 B2 *	10/2006	Schaeffer	A61N 5/06 392/416
D583,171 S *	12/2008	Tran	D6/716
D619,727 S *	7/2010	Le	D24/204
D662,211 S *	6/2012	Howe	D24/201
D701,967 S *	4/2014	Mai	D24/204
D777,461 S *	1/2017	Hashemi	D6/361
D850,133 S *	6/2019	Voorhees, Jr.	D6/361
2009/0312679 A1 *	12/2009	Elliott	A61H 9/00 601/158

* cited by examiner

Primary Examiner — Anhdao Doan

(74) *Attorney, Agent, or Firm* — Nelson Mullins Riley & Scarborough LLP

(57) **CLAIM**

The ornamental design for an apparatus for dry hydro-therapy body massage, as shown and described.

DESCRIPTION

FIG. 1 is a perspective view of an apparatus for dry hydro-therapy body massage;
 FIG. 2 is a front view thereof;
 FIG. 3 is a rear view thereof;
 FIG. 4 is a right side view thereof;
 FIG. 5 is a left side view thereof;
 FIG. 6 is a top view thereof; and,
 FIG. 7 is a bottom view thereof.

The broken lines depict portions of the apparatus for dry hydro-therapy body massage that form no part of the claimed design. The broken lines form no part of the claimed design.

1 Claim, 7 Drawing Sheets

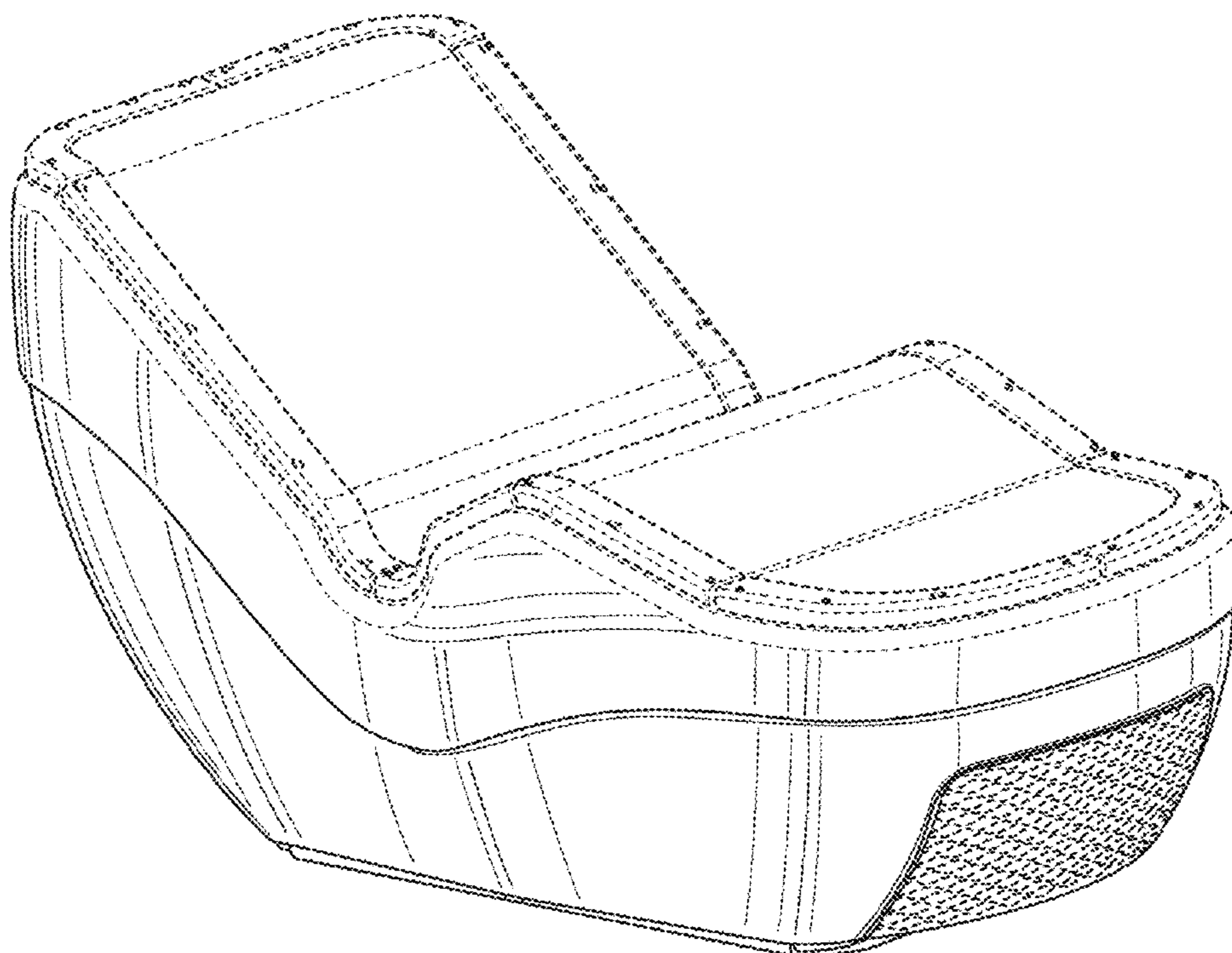

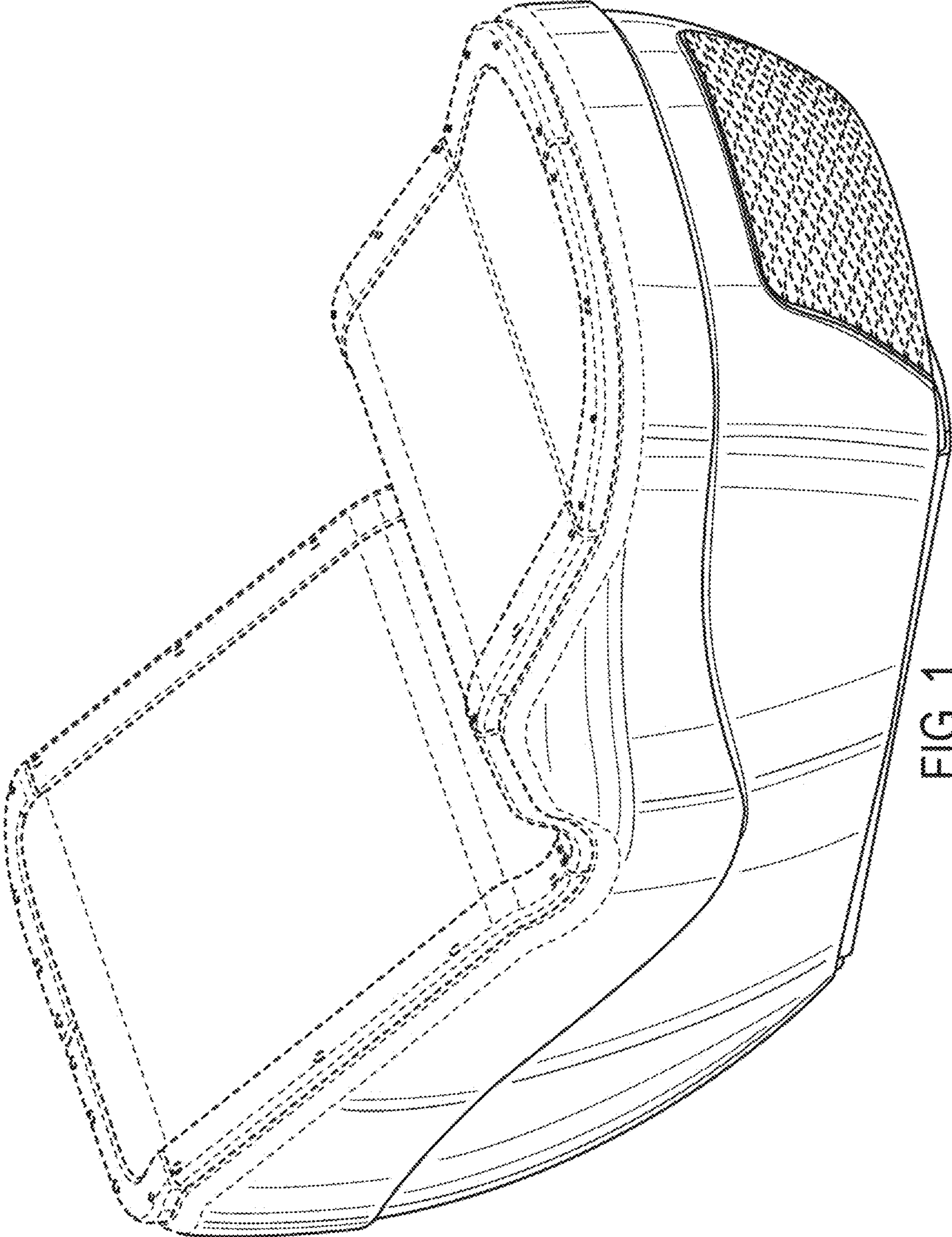

FIG. 1

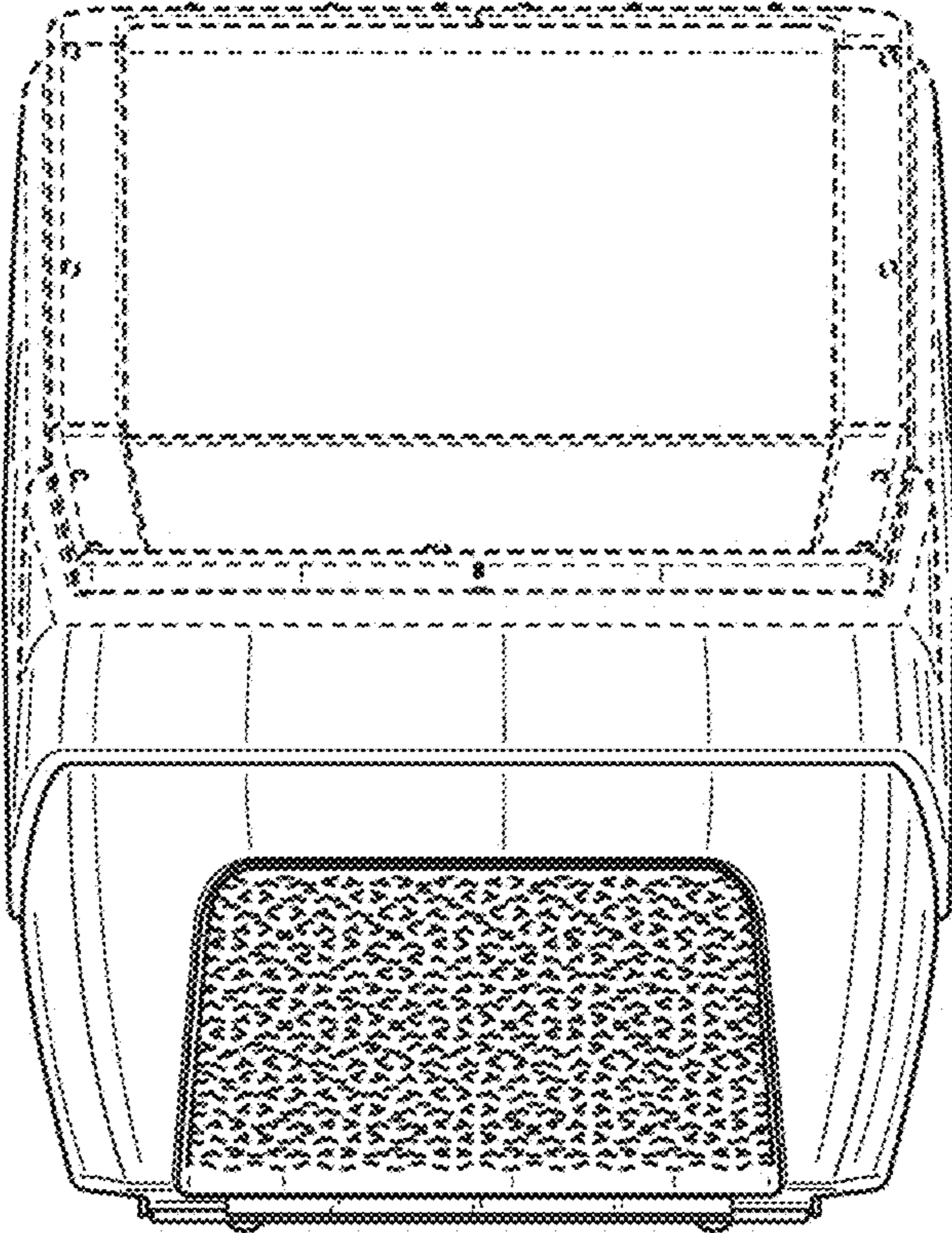

FIG. 2

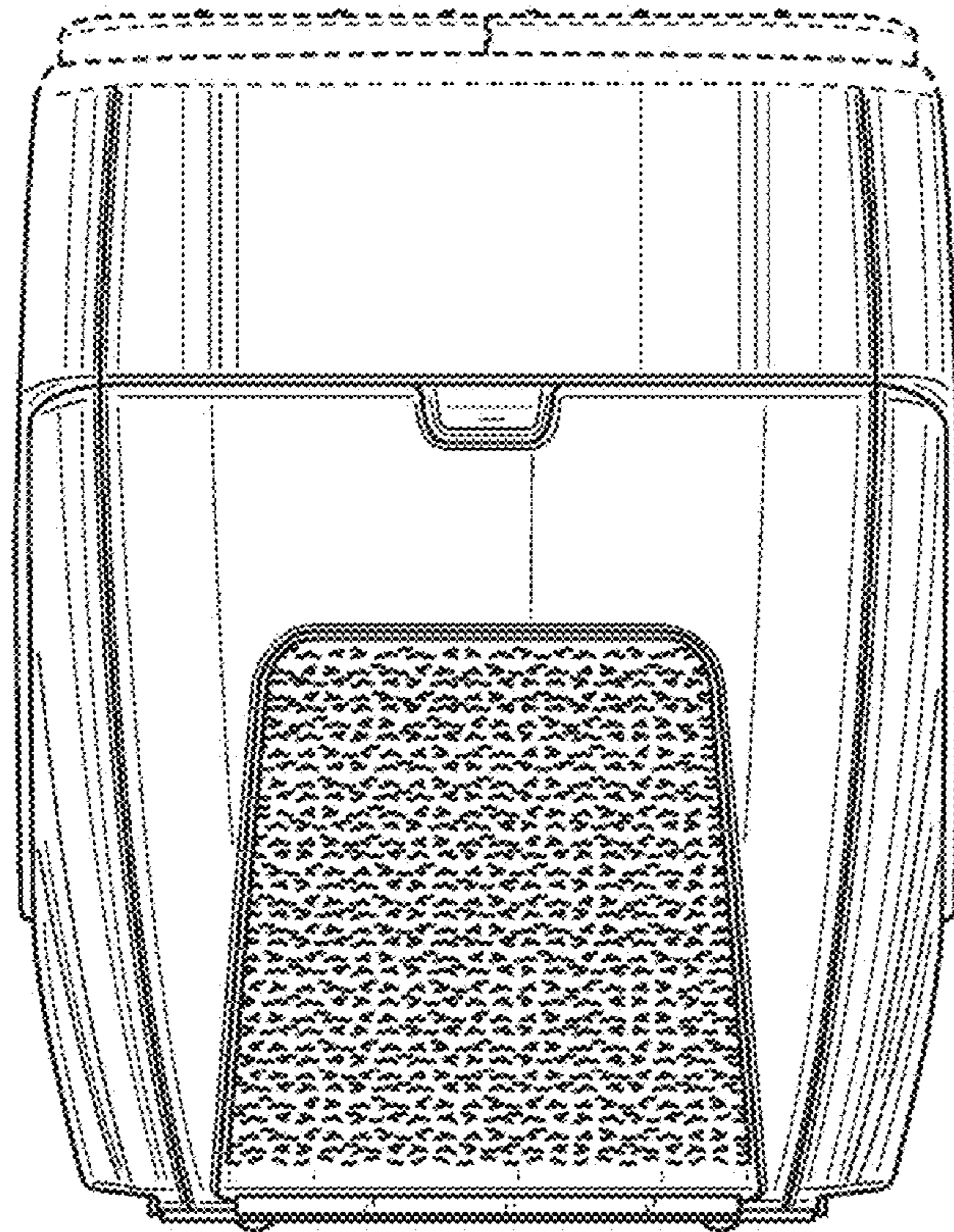

FIG. 3

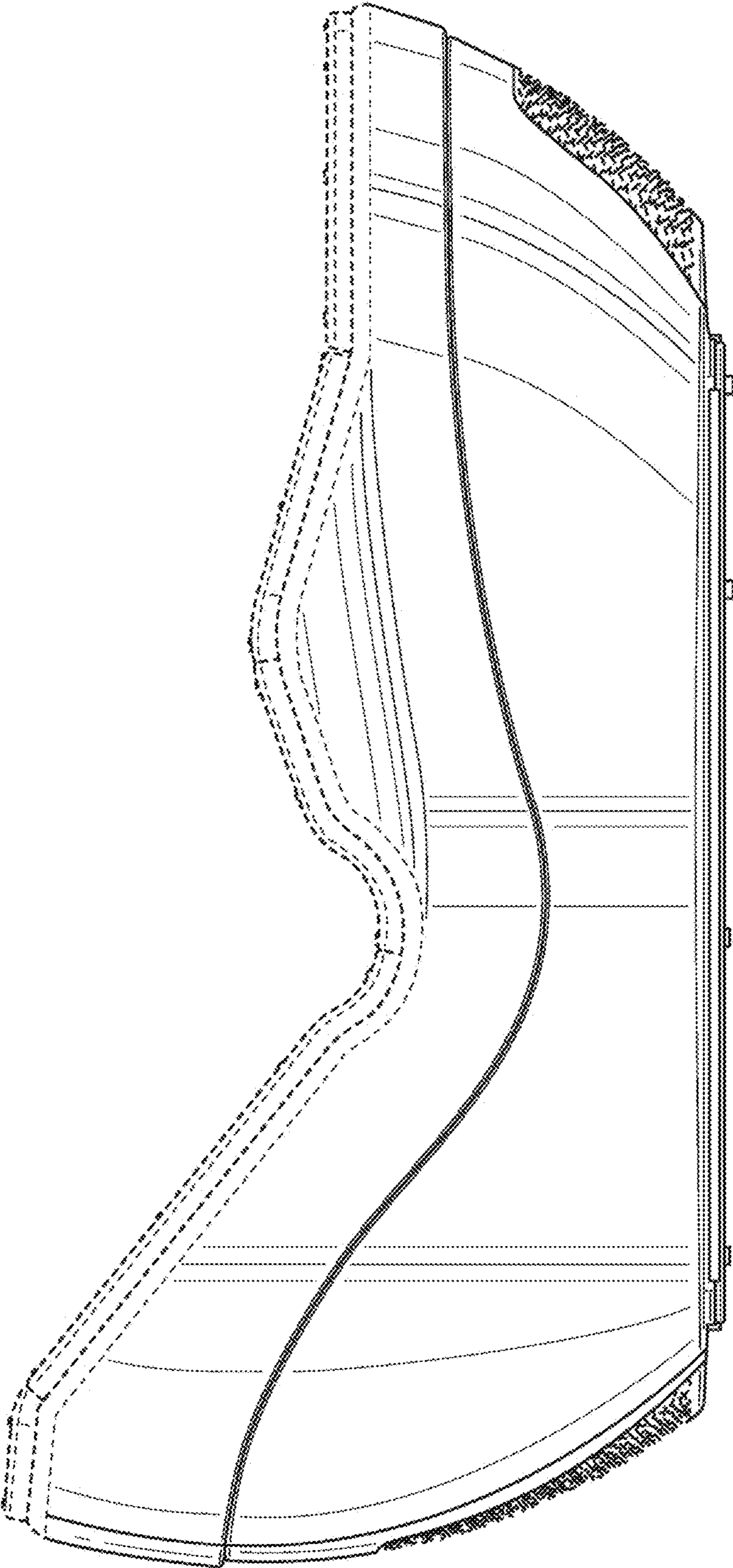

FIG. 4

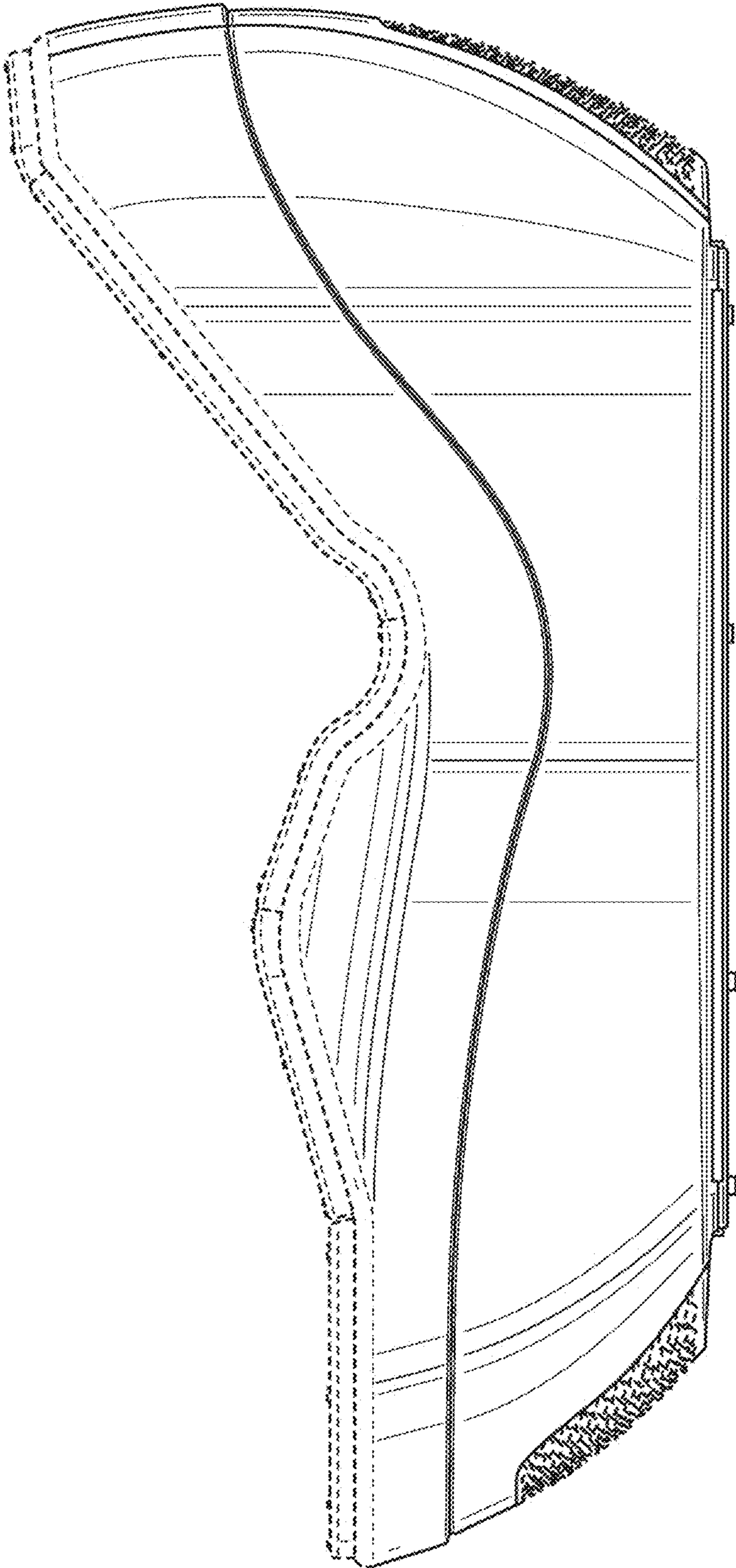

FIG. 5

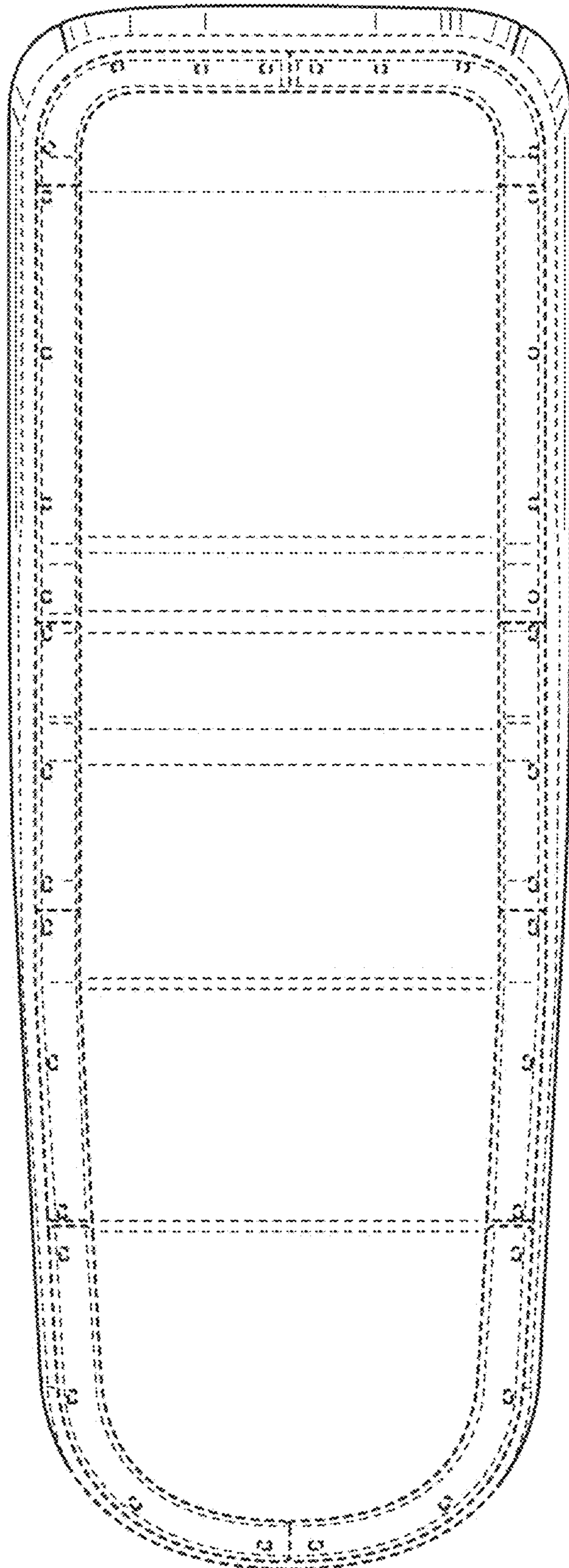

FIG. 6

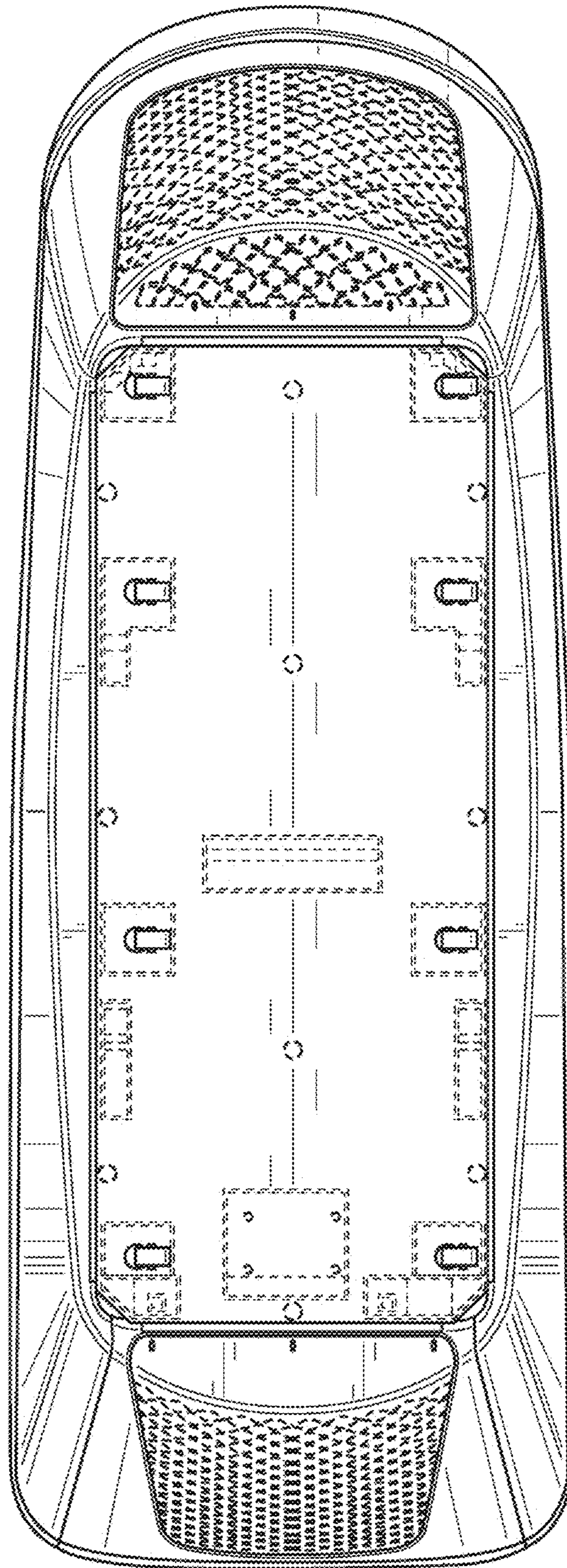

FIG. 7